

Silicon SPDT Switch, Reflective, 9 kHz to 44 GHz

FEATURES

- ▶ Ultrawideband frequency range: 9 kHz to 44 GHz
- ▶ Reflective design
- ▶ Low insertion loss with impedance match
 - ▶ 0.9 dB typical to 18 GHz
 - ▶ 1.4 dB typical to 40 GHz
 - ▶ 1.6 dB typical to 44 GHz
- ▶ Low insertion loss without impedance match
 - ▶ 0.9 dB typical to 18 GHz
 - ▶ 1.7 dB typical to 40 GHz
 - ▶ 2.2 dB typical to 44 GHz
- ▶ High input linearity
 - ▶ P1dB: 27.5 dBm typical
 - ▶ IP3: 50 dBm typical
- ▶ High RF input power handling
 - ▶ Through path: 27 dBm
 - ▶ Hot switching: 27 dBm
- ▶ No low frequency spurious
- ▶ RF settling time (50% V_{CTRL} to 0.1 dB final RF output): 3.4 μ s
- ▶ 12-terminal, 2.25 mm \times 2.25 mm LGA package
- ▶ Pin compatible with the [ADRF5024](#) fast switching version

APPLICATIONS

- ▶ Industrial scanners
- ▶ Test and instrumentation
- ▶ Cellular infrastructure: 5G mmWave
- ▶ Military radios, radars, electronic counter measures (ECMs)
- ▶ Microwave radios and very small aperture terminals (VSATs)

FUNCTIONAL BLOCK DIAGRAM

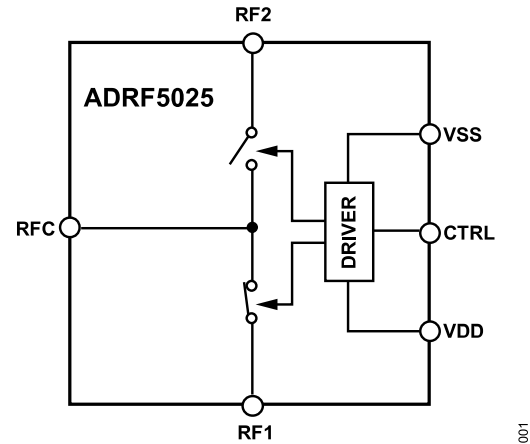

Figure 1.

GENERAL DESCRIPTION

The ADRF5025 is a reflective single-pole double-throw (SPDT) switch, manufactured in silicon process.

This switch operates from 9 kHz to 44 GHz with better than 1.6 dB of insertion loss and 35 dB of isolation. The ADRF5025 has a radio frequency (RF) input power handling capability of 27 dBm for both the through path and hot switching.

The ADRF5025 draws a low current of 14 μ A on the positive supply of +3.3 V and 120 μ A on negative supply of -3.3 V. The device employs complementary metal-oxide semiconductor (CMOS)-/low voltage transistor to transistor logic (LVTTTL)-compatible controls.

The ADRF5025 is pin compatible with the ADRF5024, low frequency cutoff version, which operates from 100 MHz to 44 GHz.

The ADRF5025 RF ports are designed to match a characteristic impedance of 50 Ω . For ultrawideband products, impedance matching on the RF transmission lines can further optimize high frequency insertion loss and return loss characteristics. Refer to the [Electrical Specifications](#) section, the [Typical Performance Characteristics](#) section, and the [Applications Information](#) section for more details.

The ADRF5025 comes in a 2.25 mm \times 2.25 mm, 12-terminal, RoHS-compliant, land grid array (LGA) package and can operate from -40°C to +105°C.

TABLE OF CONTENTS

Features.....	1	Typical Performance Characteristics.....	7
Applications.....	1	Insertion Loss, Return Loss, and Isolation.....	7
Functional Block Diagram.....	1	Input Power Compression and Third-Order	
General Description.....	1	Intercept.....	9
Specifications.....	3	Theory of Operation.....	10
Electrical Specifications.....	3	Applications Information.....	11
Absolute Maximum Ratings.....	5	Evaluation Board.....	11
Thermal Resistance.....	5	Probe Matrix Board.....	12
Power Derating Curves.....	5	Impedance Matching.....	13
ESD Caution.....	5	Outline Dimensions.....	14
Pin Configuration and Function Descriptions.....	6	Ordering Guide.....	14
Interface Schematics.....	6	Evaluation Boards.....	14

REVISION HISTORY**10/2022—Rev. B to Rev. C**

Changed V_{CTL} to V_{CTRL} (Throughout).....	1
Changes to RF Input Power Parameter, Table 1.....	3
Changes to Table 2.....	5
Changes to Figure 2.....	5
Moved Figure 11 and Figure 12.....	8

SPECIFICATIONS

ELECTRICAL SPECIFICATIONS

VDD = 3.3 V, VSS = -3.3 V, V_{CTRL} = 0 V or 3.3 V, and case temperature (T_{CASE}) = 25°C for a 50 Ω system, unless otherwise noted.

Table 1.

Parameter	Symbol	Test Conditions/Comments	Min	Typ	Max	Unit
FREQUENCY RANGE	f		0.009		44,000	MHz
INSERTION LOSS						
Between RFC and RF1/RF2 (On)						
With Impedance Match		See Figure 24				
		9 kHz to 18 GHz		0.9		dB
		18 GHz to 26 GHz		1.2		dB
		26 GHz to 35 GHz		1.3		dB
		35 GHz to 40 GHz		1.4		dB
		40 GHz to 44 GHz		1.6		dB
Without Impedance Match		See Figure 25				
		9 kHz to 18 GHz		0.9		dB
		18 GHz to 26 GHz		1.0		dB
		26 GHz to 35 GHz		1.4		dB
		35 GHz to 40 GHz		1.7		dB
		40 GHz to 44 GHz		2.2		dB
RETURN LOSS						
RFC and RF1/RF2 (On)						
With Impedance Match		See Figure 24				
		9 kHz to 18 GHz		17		dB
		18 GHz to 26 GHz		13		dB
		26 GHz to 35 GHz		12		dB
		35 GHz to 40 GHz		13		dB
		40 GHz to 44 GHz		18		dB
Without Impedance Match		See Figure 25				
		9 kHz to 18 GHz		20		dB
		18 GHz to 26 GHz		20		dB
		26 GHz to 35 GHz		13		dB
		35 GHz to 40 GHz		11		dB
		40 GHz to 44 GHz		10		dB
ISOLATION						
Between RFC and RF1/RF2						
		9 kHz to 18 GHz		42		dB
		18 GHz to 26 GHz		41		dB
		26 GHz to 35 GHz		39		dB
		35 GHz to 40 GHz		36		dB
		40 GHz to 44 GHz		35		dB
Between RF1 and RF2						
		9 kHz to 18 GHz		48		dB
		18 GHz to 26 GHz		46		dB
		26 GHz to 35 GHz		44		dB
		35 GHz to 40 GHz		43		dB
		40 GHz to 44 GHz		40		dB
SWITCHING CHARACTERISTICS						
Rise and Fall Time	t _{RISE} , t _{FALL}	10% to 90% of RF output		0.6		μs
On and Off Time	t _{ON} , t _{OFF}	50% V _{CTRL} to 90% of RF output		1.7		μs
RF Settling Time		50% V _{CTRL} to 0.1 dB of final RF output		3.4		μs

SPECIFICATIONS

Table 1.

Parameter	Symbol	Test Conditions/Comments	Min	Typ	Max	Unit
0.05 dB		50% V_{CTRL} to 0.05 dB of final RF output		4.2		μ s
INPUT LINEARITY ¹		5 MHz to 40 GHz				
1 dB Power Compression	P1dB			27.5		dBm
Third-Order Intercept	IP3	Two tone input power = 12 dBm each tone, $\Delta f = 1$ MHz		50		dBm
SUPPLY CURRENT		VDD and VSS pins				
Positive Supply Current	I_{DD}			14		μ A
Negative Supply Current	I_{SS}			120		μ A
DIGITAL CONTROL INPUTS		CTRL pin				
Voltage						
Low	V_{INL}		0		0.8	V
High	V_{INH}		1.2		3.3	V
Current						
Low and High	I_{INL}, I_{INH}			<1		μ A
RECOMMENDED OPERATING CONDITIONS						
Supply Voltage						
Positive	V_{DD}		3.15		3.45	V
Negative	V_{SS}		-3.45		-3.15	V
Digital Control Voltage	V_{CTRL}		0		V_{DD}	V
RF Input Power ²	P_{IN}	$f = 10$ MHz to 40 GHz, $T_{CASE} = 85^{\circ}\text{C}$ ³				
Input at RFC						
Through Path		RF signal is applied to RFC			27	dBm
Hot Switching		RF signal is present at RFC while switching between RF1 and RF2			27	dBm
Input at RFx						
Through Path		RF signal is applied through connected RFx			26	dBm
Hot Switching		RF signal is present at RFx while switching between RF1 and RF2			26	dBm
Case Temperature	T_{CASE}		-40		+105	$^{\circ}\text{C}$

¹ For input linearity performance over frequency, see [Figure 13](#) to [Figure 16](#).

² For power derating over frequency, see [Figure 2](#) and [Figure 3](#).

³ For 105 $^{\circ}\text{C}$ operation, the power handling degrades from the $T_{CASE} = 85^{\circ}\text{C}$ specification by 3 dB.

ABSOLUTE MAXIMUM RATINGS

For the recommended operating conditions, see [Table 1](#).

Table 2.

Parameter	Rating
Positive Supply Voltage	-0.3 V to +3.6 V
Negative Supply Voltage	-3.6 V to +0.3 V
Digital Control Input Voltage	
Voltage	-0.3 V to VDD + 0.3 V
Current	3 mA
RF Input Power ¹ (f = 10 MHz to 40 GHz, T _{CASE} = 85°C ²)	
Input at RFC	
Through Path	27.5 dBm
Hot Switching	27.5 dBm
Input at RFx	
Through Path	26.5 dBm
Hot Switching	26.5 dBm
RF Input Power Under Unbiased Condition ¹ (V _{DD} , V _{SS} = 0 V)	21 dBm
Temperature	
Junction, T _J	135°C
Storage Range	-65°C to +150°C
Reflow	260°C
ESD Sensitivity	
Human Body Model (HBM)	
RFC, RF1, and RF2 Pins	1000 V
Digital Pins	2000 V
Charged Device Model (CDM)	1250 V

¹ For power derating vs. frequency, see [Figure 2](#) and [Figure 3](#). This power derating is applicable for insertion loss path and hot switching power specifications.

² For 105°C operation, the power handling degrades from the T_{CASE} = 85°C specification by 3 dB.

Stresses at or above those listed under Absolute Maximum Ratings may cause permanent damage to the product. This is a stress rating only; functional operation of the product at these or any other conditions above those indicated in the operational section of this specification is not implied. Operation beyond the maximum operating conditions for extended periods may affect product reliability.

Only one absolute maximum rating can be applied at any one time.

THERMAL RESISTANCE

Thermal performance is directly linked to printed circuit board (PCB) design and operating environment. Careful attention to PCB thermal design is required.

θ_{JC} is the junction to case bottom (channel to package bottom) thermal resistance.

Table 3. Thermal Resistance

Package Type	θ _{JC}	Unit
CC-12-3, Through Path	352	°C/W

POWER DERATING CURVES

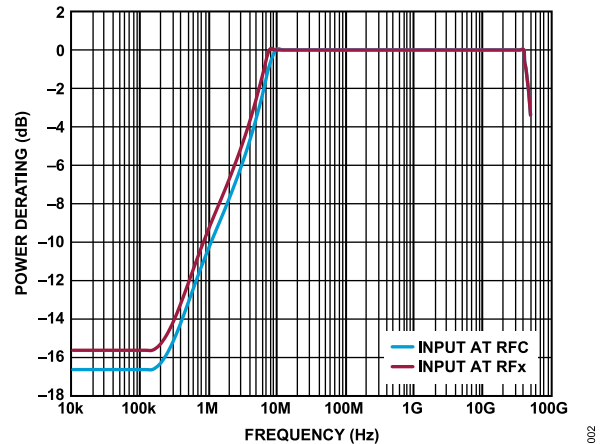

Figure 2. Power Derating vs. Frequency, Low Frequency Detail, T_{CASE} = 85°C

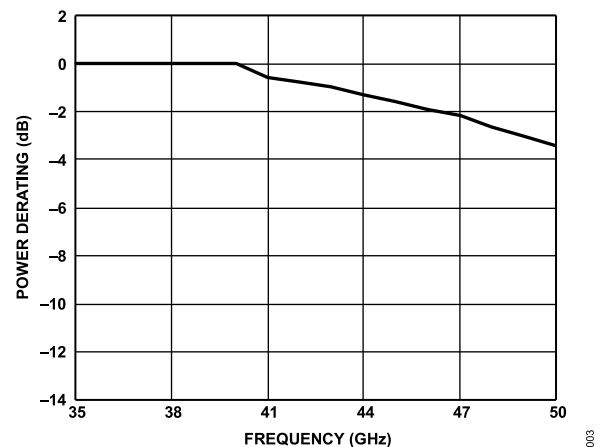

Figure 3. Power Derating vs. Frequency, High Frequency Detail, T_{CASE} = 85°C

ESD CAUTION



ESD (electrostatic discharge) sensitive device. Charged devices and circuit boards can discharge without detection. Although this product features patented or proprietary protection circuitry, damage may occur on devices subjected to high energy ESD. Therefore, proper ESD precautions should be taken to avoid performance degradation or loss of functionality.

PIN CONFIGURATION AND FUNCTION DESCRIPTIONS

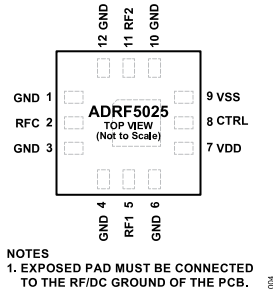

Figure 4. Pin Configuration (Top View)

Table 4. Pin Function Descriptions

Pin No.	Mnemonic	Description
1, 3, 4, 6, 10, 12	GND	Ground. These pins must be connected to the RF/dc ground of the PCB.
2	RFC	RF Common Port. This pin is dc-coupled to 0 V and ac matched to 50 Ω. No dc blocking capacitor is necessary when the RF line potential is equal to 0 V dc. See Figure 5 for the interface schematic.
5	RF1	RF Port 1. This pin is dc-coupled to 0 V and ac matched to 50 Ω. No dc blocking capacitor is necessary when the RF line potential is equal to 0 V dc. See Figure 5 for the interface schematic.
7	VDD	Positive Supply Voltage.
8	CTRL	Control Input Voltage. See Figure 6 for the interface schematic.
9	VSS	Negative Supply Voltage.
11	RF2	RF Port 2. This pin is dc-coupled to 0 V and ac matched to 50 Ω. No dc blocking capacitor is necessary when the RF line potential is equal to 0 V dc. See Figure 5 for the interface schematic.
	EPAD	Exposed Pad. The exposed pad must be connected to the RF/dc ground of the PCB.

INTERFACE SCHEMATICS

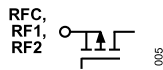

Figure 5. RFx Pins Interface Schematic

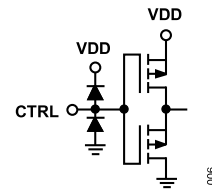

Figure 6. CTRL Interface Schematic

TYPICAL PERFORMANCE CHARACTERISTICS

INSERTION LOSS, RETURN LOSS, AND ISOLATION

VDD = 3.3 V, VSS = -3.3 V, V_{CTRL} = 0 V or VDD, and T_{CASE} = 25°C for a 50 Ω system, unless otherwise noted.

Insertion loss and return loss are measured on the probe matrix board using ground-signal-ground (GSG) probes close to the RFx pins. See the [Applications Information](#) section for details on the evaluation and probe matrix boards.

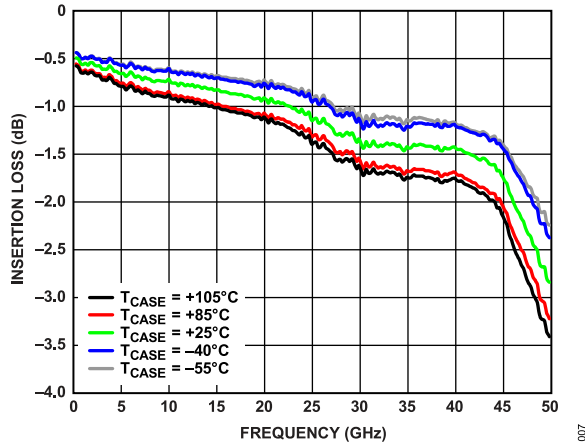

Figure 7. Insertion Loss vs. Frequency with Impedance Match

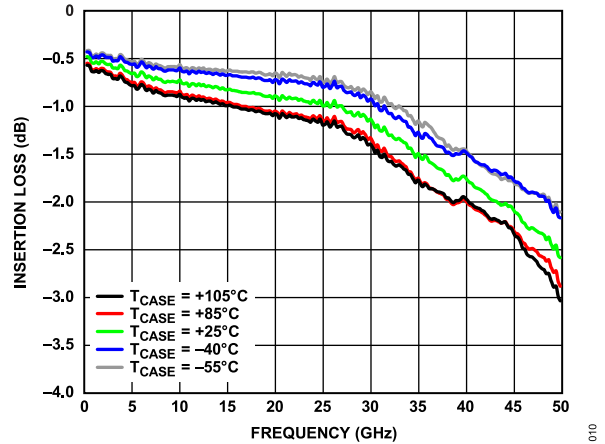

Figure 9. Insertion Loss vs. Frequency Without Impedance Match

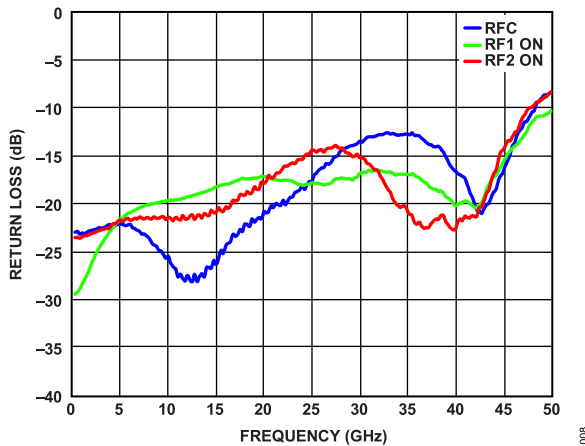

Figure 8. Return Loss vs. Frequency for RFC and RFx (On) with Impedance Match

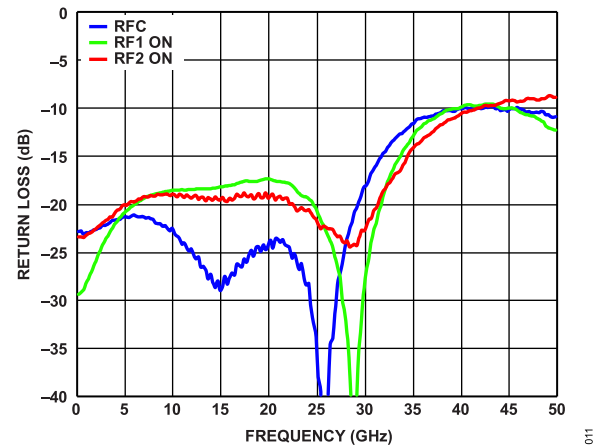

Figure 10. Return Loss vs. Frequency for RFC and RFx (On) Without Impedance Match

TYPICAL PERFORMANCE CHARACTERISTICS

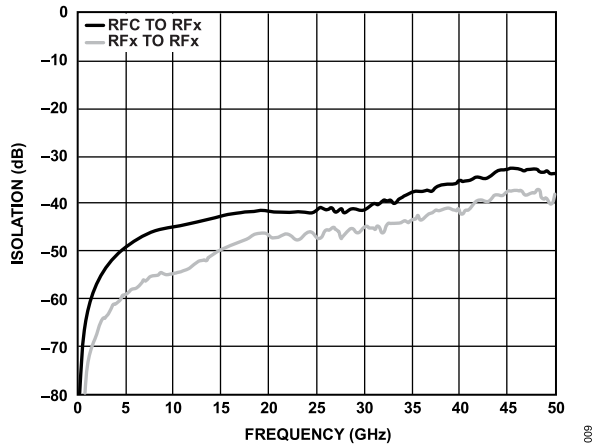

Figure 11. Isolation vs. Frequency with Impedance Match

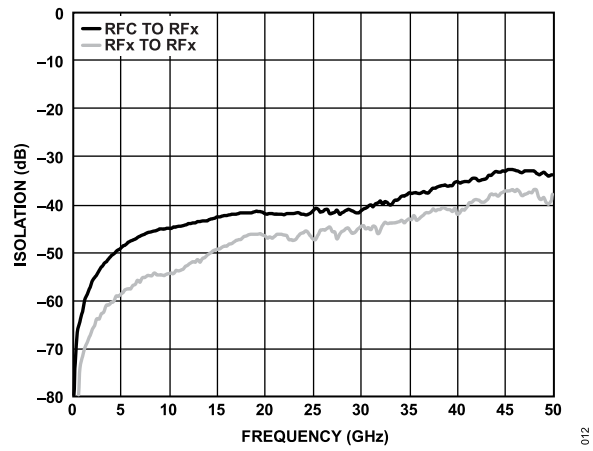

Figure 12. Isolation vs. Frequency Without Impedance Match

TYPICAL PERFORMANCE CHARACTERISTICS

INPUT POWER COMPRESSION AND THIRD-ORDER INTERCEPT

VDD = 3.3 V, VSS = -3.3 V, VCTRL = 0 V or VDD, and T_{CASE} = 25°C for a 50 Ω system, unless otherwise noted. All of the large signal performance parameters were measured on the evaluation board.

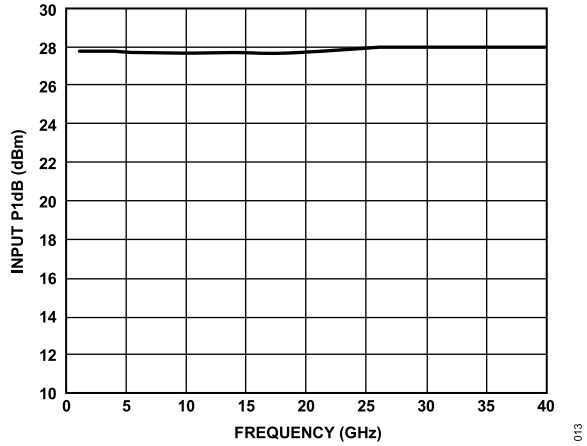

Figure 13. Input P1dB vs. Frequency

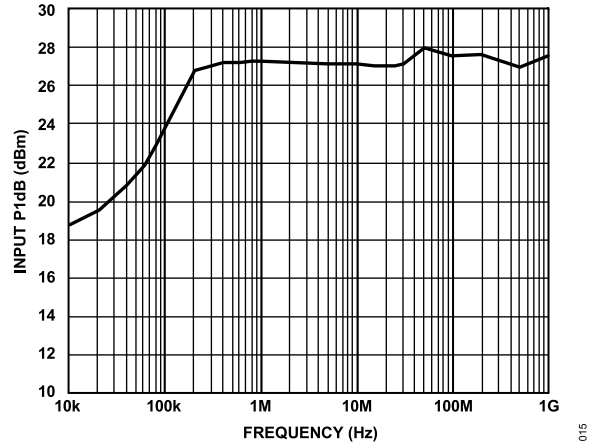

Figure 15. Input P1dB vs. Frequency (Low Frequency Detail)

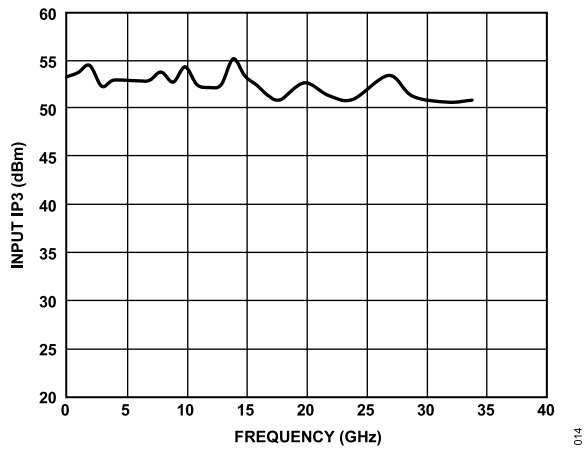

Figure 14. Input IP3 vs. Frequency over Temperature

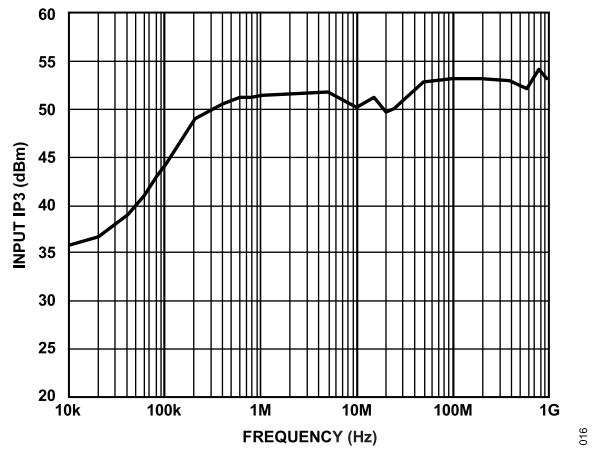

Figure 16. Input IP3 vs. Frequency over Temperature (Low Frequency Detail)

THEORY OF OPERATION

The ADRF5025 requires a positive supply voltage applied to the VDD pin and a negative supply voltage applied to the VSS pin. Bypassing capacitors are recommended on the supply lines to filter high frequency noise.

All of the RF ports (RFC, RF1, and RF2) are dc-coupled to 0 V, and no dc blocking is required at the RF ports when the RF line potential is equal to 0 V.

The RF ports are internally matched to 50 Ω . Therefore, external matching networks are not required. However, impedance matching on transmission lines can be used to improve insertion loss and return loss performance at high frequencies.

The ADRF5025 integrates a driver to perform logic functions internally and provides the user with the advantage of a simplified CMOS/LVTTL-compatible control interface. This driver features a single digital control input pin, CTRL. The logic level applied to the CTRL pin determines which RF port is in the insertion loss state and in the isolation state (see [Table 5](#)).

The unselected RF port of the ADRF5025 is reflective. The isolation path provides high isolation between the unselected port and the insertion loss path.

The ideal power-up sequence is as follows:

1. Connect GND.
2. Power up VDD and VSS. Power up VSS after VDD to avoid current transients on VDD during ramp-up.
3. Apply the digital control inputs. The relative order of the control inputs is not important. However, powering the digital control inputs before the VDD supply may inadvertently forward bias and damage the internal ESD protection structures. To avoid this damage, use a series 1 k Ω resistor to limit the current flowing in to the control pin. Use pull-up or pull-down resistors if the controller is in a high impedance state after VDD is powered up and the control pins are not driven to a valid logic state.
4. Apply an RF input signal.

The ideal power-down sequence is the reverse order of the power-up sequence.

Table 5. Control Voltage Truth Table

Digital Control Input (V_{CTRL})	RF Path	
	RF1 to RFC	RF2 to RFC
Low	Isolation (off)	Insertion loss (on)
High	Insertion loss (on)	Isolation (off)

APPLICATIONS INFORMATION

EVALUATION BOARD

The ADRF5025-EVALZ is a 4-layer evaluation board. The outer copper (Cu) layers are 0.5 oz (0.7 mil) plated to 1.5 oz (2.2 mil) and are separated by dielectric materials. Figure 17 shows the evaluation board stackup.

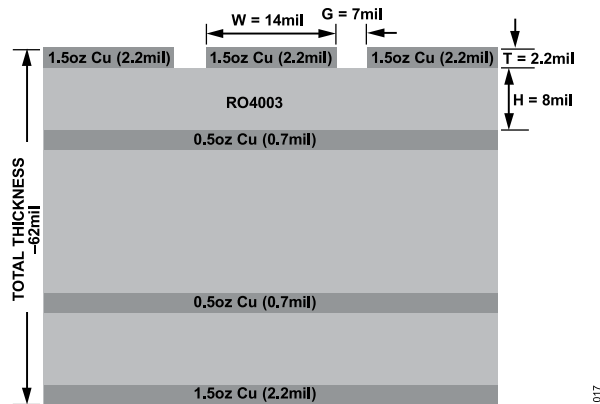

Figure 17. Evaluation Board (Cross Section View)

All RF and dc traces are routed on the top copper layer, whereas the inner and bottom layers are grounded planes that provide a solid ground for the RF transmission lines. The top dielectric material is 8 mil Rogers RO4003, offering optimal high frequency performance. The middle and bottom dielectric materials provide mechanical strength. The overall board thickness is 62 mil, which allows 2.4 mm RF launchers to be connected at the board edges.

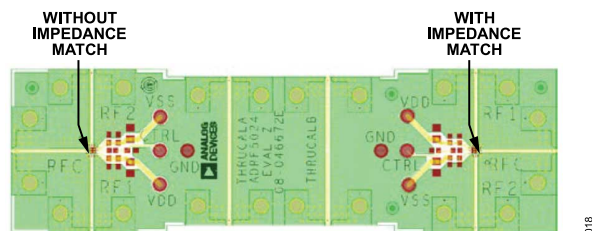

Figure 18. Evaluation Board Layout, Top View

The RF transmission lines were designed using a coplanar waveguide (CPWG) model, with trace width of 14 mil and ground clearance of 7 mil to have a characteristic impedance of 50 Ω . For optimal RF and thermal grounding, as many plated through vias as possible are arranged around transmission lines and under the exposed pad of the package.

The ADRF5025-EVALZ has two layouts implemented; with and without impedance matching. By default, the impedance matched circuit is populated. For more details on the impedance matched circuit, refer to the [Impedance Matching](#) section in the [Probe Matrix Board](#) section.

THRU CAL can be used to calibrate out the board loss effects from the ADRF5025-EVALZ evaluation board measurements to determine the device performance at the pins of the IC. Figure 19 shows the typical board loss for the ADRF5025-EVALZ evaluation board at room temperature, the embedded insertion loss, and the de-embedded insertion loss for the ADRF5025.

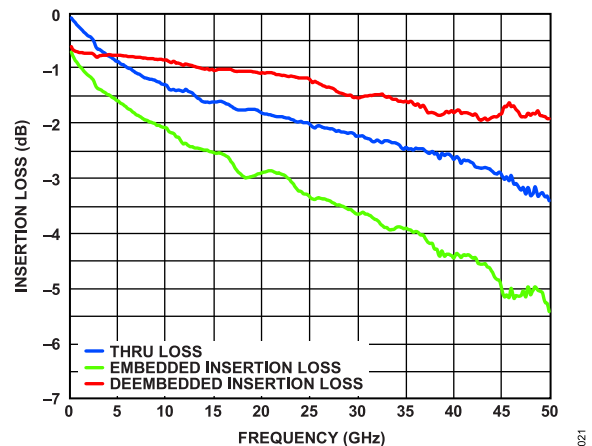

Figure 19. Insertion Loss vs. Frequency

Figure 20 shows the actual ADRF5025-EVALZ with its component placement.

Two power supply ports are connected to the VDD and VSS test points, TP7 and TP5 (or TP3 and TP1 if using without the impedance match circuit), and the ground reference is connected to the GND test point, TP4 or TP8. On the supply traces, VDD and VSS, a 100 pF bypass capacitor filters high frequency noise. Additionally, unpopulated components positions are available for applying extra bypass capacitors.

A control port is connected to the CTRL test point, TP6 (or TP2 for without the impedance match circuit). There are provisions for the resistor capacitor (RC) filter to eliminate dc-coupled noise, if needed, by the application. The resistor can also improve the isolation between the RF and the control signal.

The RF input and output ports (RFC, RF1, and RF2) are connected through 50 Ω transmission lines to the 2.4 mm RF launchers, J10, J9, and J8 (or J2, J3, and J1 for the without impedance match circuit), respectively. These high frequency RF launchers are by contact and are not soldered to the board. A THRU CAL line connects the unpopulated J6 and J7 launchers (or J4 and J5 for without the impedance match circuit). This transmission line is used to estimate the loss due to the PCB over the environmental conditions being evaluated.

The schematic of the ADRF5025-EVALZ evaluation board is shown in Figure 21.

APPLICATIONS INFORMATION

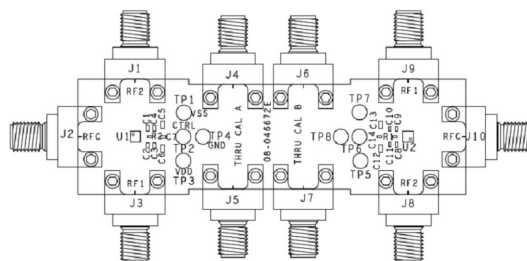

Figure 20. Evaluation Board Component Placement

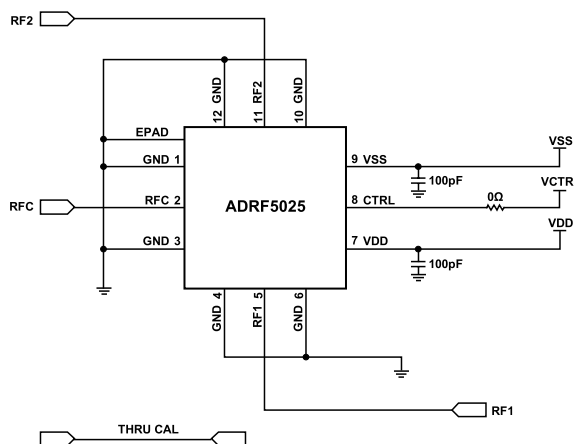

Figure 21. Simplified Evaluation Board Schematic

Table 6. Evaluation Board Components

Component	Default Value	Description
C8, C9	100 pF	Capacitors, C0402 package
J8 to J10	Not applicable	2.4 mm end launch connectors (Southwest Microwave: 1492-04A-5)
R2	0 Ω	Resistor, 0402 package
TP5 to TP8	Not applicable	Through hole mount test points
U2	ADRF5025	ADRF5025 SPDT switch, Analog Devices, Inc.
PCB	08-046672E	Evaluation PCB, Analog Devices

PROBE MATRIX BOARD

The probe matrix board is a 4-layer board. Similar to the evaluation board, this board also uses a 8 mil Rogers RO4003 dielectric. The outer copper layers are 0.5 oz (0.7 mil) copper plated to 1.5 oz (2.2 mil). The RF transmission lines were designed using a CPWG model with a width of 14 mil and ground spacing of 7 mil to have a characteristic impedance of 50 Ω.

Figure 22 and Figure 23 show the cross section and top view of the board, respectively. Measurements are made using GSG probes at close proximity to the RFx pins. Unlike the evaluation board, probing reduces reflections caused by mismatch arising from connectors, cables, and board layout, resulting in a more accurate measurement of the device performance.



Figure 22. Probe Matrix Board (Cross Section View)

APPLICATIONS INFORMATION

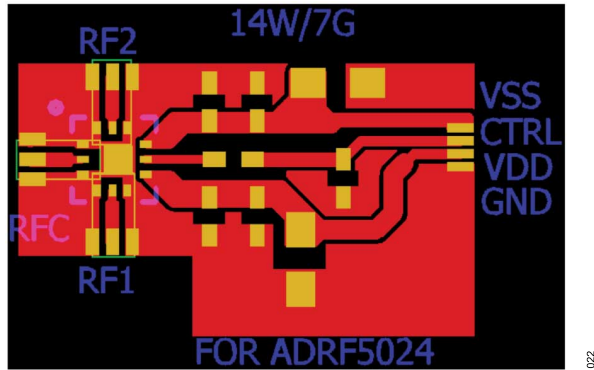

Figure 23. Probe Board Layout (Top View)

The probe matrix board includes a through reflect line (TRL) calibration kit allowing board loss de-embedding. The actual board duplicates the same layout in matrix form to assemble multiple devices at one time. All S parameters were measured on this board.

IMPEDANCE MATCHING

Impedance matching at the RFx pins can improve the insertion loss and return loss at high frequencies. Figure 24 and Figure 25 show the difference in the transmission lines at the RFC, RF1, and RF2 pins. This same circuit is implemented on the probe matrix boards and the evaluation boards.

The dimensions of the 50 Ω lines are 14 mil trace width and 7 mil gap. To implement this impedance matched circuit, a 5 mil trace with a width of 5 mils was inserted between the pin pad and the 50 Ω trace. The calibration kit reference kit does not include the 5 mil matching line, and therefore, the measured insertion loss includes the losses of the matching circuit.

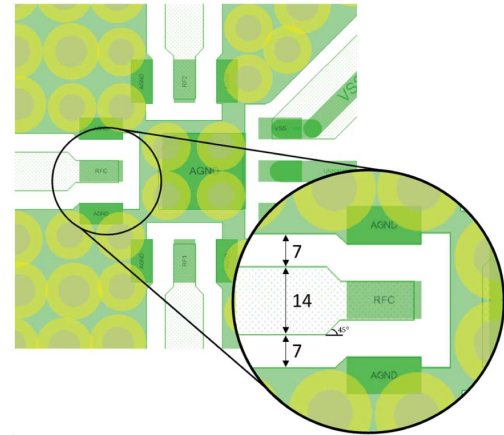

Figure 25. Without Impedance Match

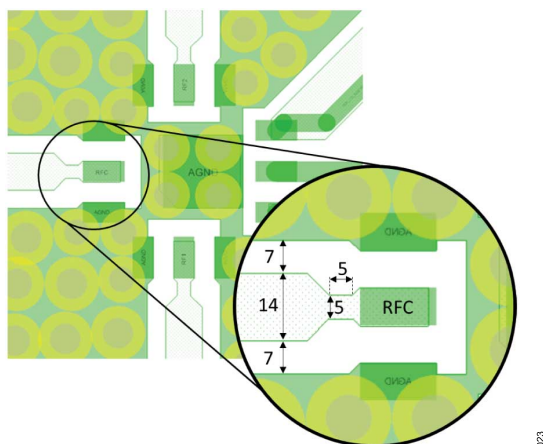
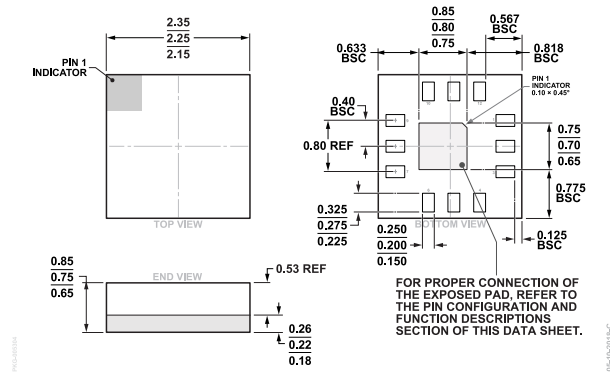

Figure 24. With Impedance Match

OUTLINE DIMENSIONS



**Figure 26. 12-Terminal Land Grid Array [LGA]
2.25 mm x 2.25 mm Body and 0.75 mm Package Height
(CC-12-3)
Dimensions shown in millimeters**

Updated: October 17, 2022

ORDERING GUIDE

Model ¹	Temperature Range	Package Description	Packing Quantity	Package Option	Marking Code
ADRF5025BCCZN	-40°C to +105°C	12-Lead LGA (2.25mm x 2.25mm x 0.75mm w/ EP)	Reel, 100	CC-12-3	025
ADRF5025BCCZN-R7	-40°C to +105°C	12-Lead LGA (2.25mm x 2.25mm x 0.75mm w/ EP)	Reel, 500	CC-12-3	025

¹ Z = RoHS Compliant Part.

EVALUATION BOARDS

Model ¹	Description
ADRF5025-EVALZ	Evaluation Board

¹ Z = RoHS Compliant Part.