

MC12XS6 Evaluation Boards

External Lighting Multichannel Scalable Switches

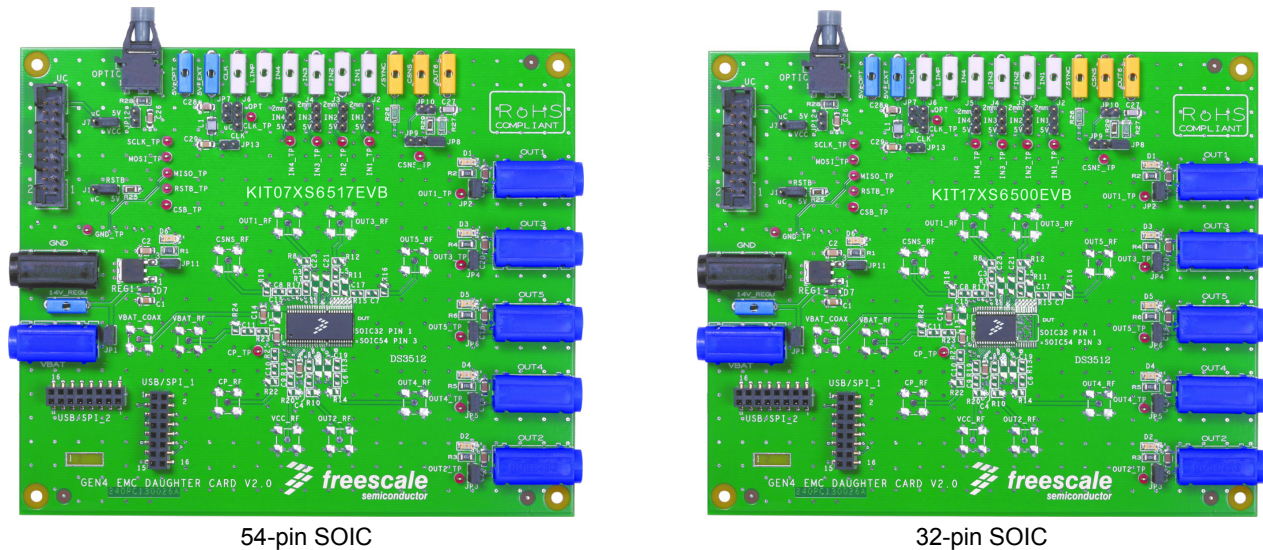

54-pin SOIC

32-pin SOIC

Figure 1. eXtreme Switch Evaluation Boards

This User Guide features the MC12XS6 family of devices, the 32 or 54-pin board layout is designed for easy evaluation of the following products:

Table 1. MC12XS6 Family Devices

Product	Number of Outputs	R _{DS(on)} (mΩ)	Package	Suggested Tool
MC07XS6517	Penta	3 x 7.0, 2 x 17.0	SOIC EP 54	KIT07XS6517EVB
MC08XS6421	Quad	2 x 8.0, 2 x 21.0	SOIC EP 32	KIT08XS6421EKEVB
MC10XS6200	Dual	2 x 10.0	SOIC EP 32	KIT10XS6200EKEVB
MC10XS6225	Dual	1 x 10, 1 x 25	SOIC EP 32	KIT10XS6225EKEVB
MC10XS6325	Triple	2 x 10.0, 1 x 25.0	SOIC EP 32	KIT10XS6325EKEVB
MC17XS6400	Quad	4 x 17.0	SOIC EP 32	KIT17XS6400EKEVB
MC17XS6500	Penta	5 x 17.0	SOIC EP 32	KIT17XS6500EVB
MC25XS6300	Triple	3 x 25.0	SOIC EP 32	KIT25XS6300EKEVB
MC40XS6500	Penta	5 x 40.0	SOIC EP 32	KIT40XS6500EKEVB



Contents

1 Kit Contents/Packing List	3
2 Jump Start	3
3 Important Notice	4
4 Introduction	5
5 Evaluation Board Features	5
6 MC12XS6 Device Features	6
7 Accessory Interface Board	6
8 Required Equipment	7
9 Evaluation Board Configuration	8
10 Installing SPIGen Freeware on your Computer	9
11 Setting Up and Using the Hardware	10
12 Evaluation Board Hardware Description	11
13 Schematic	16
14 Board Layout	18
15 Bill of Materials	24
16 References	26
17 Revision History	27

1 Kit Contents/Packing List

- Assembled and tested evaluation board/module in anti-static bag.
- Warranty card

2 Jump Start

- Go to www.freescale.com/analogtools
- Locate your kit
- Review your Tool Summary Page
- Look for



Jump Start Your Design

- Download documents, software and other information

3 Important Notice

Freescale provides the enclosed product(s) under the following conditions:

This evaluation kit is intended for use of ENGINEERING DEVELOPMENT OR EVALUATION PURPOSES ONLY. It is provided as a sample IC pre-soldered to a printed circuit board to make it easier to access inputs, outputs, and supply terminals. This evaluation board may be used with any development system or other source of I/O signals by simply connecting it to the host MCU or computer board via off-the-shelf cables. This evaluation board is not a Reference Design and is not intended to represent a final design recommendation for any particular application. Final device in an application will be heavily dependent on proper printed circuit board layout and heat sinking design as well as attention to supply filtering, transient suppression, and I/O signal quality.

The goods provided may not be complete in terms of required design, marketing, and or manufacturing related protective considerations, including product safety measures typically found in the end product incorporating the goods. Due to the open construction of the product, it is the user's responsibility to take any and all appropriate precautions with regard to electrostatic discharge. In order to minimize risks associated with the customers applications, adequate design and operating safeguards must be provided by the customer to minimize inherent or procedural hazards. For any safety concerns, contact Freescale sales and technical support services.

Should this evaluation kit not meet the specifications indicated in the kit, it may be returned within 30 days from the date of delivery and will be replaced by a new kit.

Freescale reserves the right to make changes without further notice to any products herein. Freescale makes no warranty, representation or guarantee regarding the suitability of its products for any particular purpose, nor does Freescale assume any liability arising out of the application or use of any product or circuit, and specifically disclaims any and all liability, including without limitation consequential or incidental damages. "Typical" parameters can and do vary in different applications and actual performance may vary over time. All operating parameters, including "Typical", must be validated for each customer application by customer's technical experts.

Freescale does not convey any license under its patent rights nor the rights of others. Freescale products are not designed, intended, or authorized for use as components in systems intended for surgical implant into the body, or other applications intended to support or sustain life, or for any other application in which the failure of the Freescale product could create a situation where personal injury or death may occur.

Should the Buyer purchase or use Freescale products for any such unintended or unauthorized application, the Buyer shall indemnify and hold Freescale and its officers, employees, subsidiaries, affiliates, and distributors harmless against all claims, costs, damages, and expenses, and reasonable attorney fees arising out of, directly or indirectly, any claim of personal injury or death associated with such unintended or unauthorized use, even if such claim alleges that Freescale was negligent regarding the design or manufacture of the part. Freescale™ and the Freescale logo are trademarks of Freescale Semiconductor, Inc. All other product or service names are the property of their respective owners.

© Freescale Semiconductor, Inc. 2014

4 Introduction

This evaluation board demonstrates the capability of the latest eXtreme Switch Gen4 family. This SMARTMOS family offers new combinations of output channels as well as a selection of $R_{DS(on)}$ values. All devices in [Table 1](#) are footprint-compatible; therefore, they can all be evaluated using this evaluation board.

This evaluation board can be used to evaluate the high-side devices in [Table 1](#), which feature integrated control with high flexibility, and high number of protection and diagnostic functions. These devices are designed for low-voltage automotive lighting applications and can drive a wide range of sources, including HIB ballasts and LEDs.

Programming, control, and diagnostics are accomplished using a 16-bit SPI interface, which makes possible a large array of configurations, diagnostics, and protection features. For example:

- Configuration: Output slew rates, PWM frequency with prescaler, output phasing, current sense precision, etc.
- Protection and diagnostics: under/overvoltage, thermal warning, overcurrent, OpenLoad, SPI fail, etc.

These devices also provide analog feedback of the IC's temperature, battery voltage, or selectable-channel current sensing with high precision.

The two, three, four, or five channels can be controlled individually by external clock signal or in fail-safe mode by using direct inputs (available for OUT1 through OUT4). This fail-safe mode operation happens whenever communication with the external microcontroller is lost (due to watchdog timeout) and all protection as well as control remains operational.

5 Evaluation Board Features

These evaluation boards consist of either an SOIC 54 or 32 pin ICs, with exposed pads.

This board can control up to:

- Five separate 28 W bulbs
- Three separate 55 W HID ballasts
- Five separate LED modules
- Five separate loads of other types

Device can be driven by the 16-bit SPI using KITUSBSPIDGLEVME with SPIGen software or with direct input signals in Fail safe mode operation. It also offers the possibility to apply an external clock in order to drive outputs in PWM operation.

6 MC12XS6 Device Features

MC12XS6 family devices are SMARTPOWER ICs intended for lighting applications. The devices supports the following functions:

Table 2. MC12XS6 Family Devices

Product	Number of Outputs	R _{DS(on)} (mΩ)	Package
MC07XS6517	Penta	3 x 7.0, 2 x 17.0	SOIC EP 54
MC08XS6421	Quad	2 x 8.0, 2 x 21.0	SOIC EP 32
MC10XS6200	Dual	2 x 10.0	SOIC EP 32
MC10XS6225	Dual	1 x 10, 1 x 25	SOIC EP 32
MC10XS6325	Triple	2 x 10.0, 1 x 25.0	SOIC EP 32
MC17XS6400	Quad	4 x 17.0	SOIC EP 32
MC17XS6500	Penta	5 x 17.0	SOIC EP 32
MC25XS6300	Triple	3 x 25.0	SOIC EP 32
MC40XS6500	Penta	5 x 40.0	SOIC EP 32

- Operating voltage range from 6.0 V to 18 V with sleep current < 5.0 μA.
- 16-bit 5.0 V SPI control, programming and status reporting with daisy chain capability
- PWM module using external clock with programmable slew rates (to satisfy EMC requirements), 8-bit flexibility for duty cycle and output delay management.
- Smart overcurrent shutdown, severe short circuit detection, overtemperature protections, output short to battery, undervoltage or overvoltage reporting, etc.
- Open load detection in On or Off state, available for bulbs and LEDs
- Analog temperature and voltage feedback, so current with selectable ratio is optimized for LEDs modules

7 Accessory Interface Board

The MC12XS6 Evaluation boards may be used with the KITUSBSPIDGLEVME interface dongle (shown below), which provides a USB-to-SPI interface. This small board makes use of the USB and SPI ports built into Freescale’s MC68HC908JW32 microcontroller. The main function provided by this dongle is to allow Freescale evaluation boards that have an SPI port to communicate with a PC through its USB port.



Figure 2. KITUSBSPIDGLEVME Interface Dongle

8 Required Equipment

Minimum equipment required:

- Minimum equipment required for optimal use:
- DC Power supply 30 V/40 A
- Clock signal generator 0-100 kHz
- Computer with an available USB port, running Windows XP or higher
- KITUSBSPIDGLEVME interface board
- Latest version of SPIGen software (available through www.freescale.com/analogtools)
- Typical loads (lamps)

9 Evaluation Board Configuration

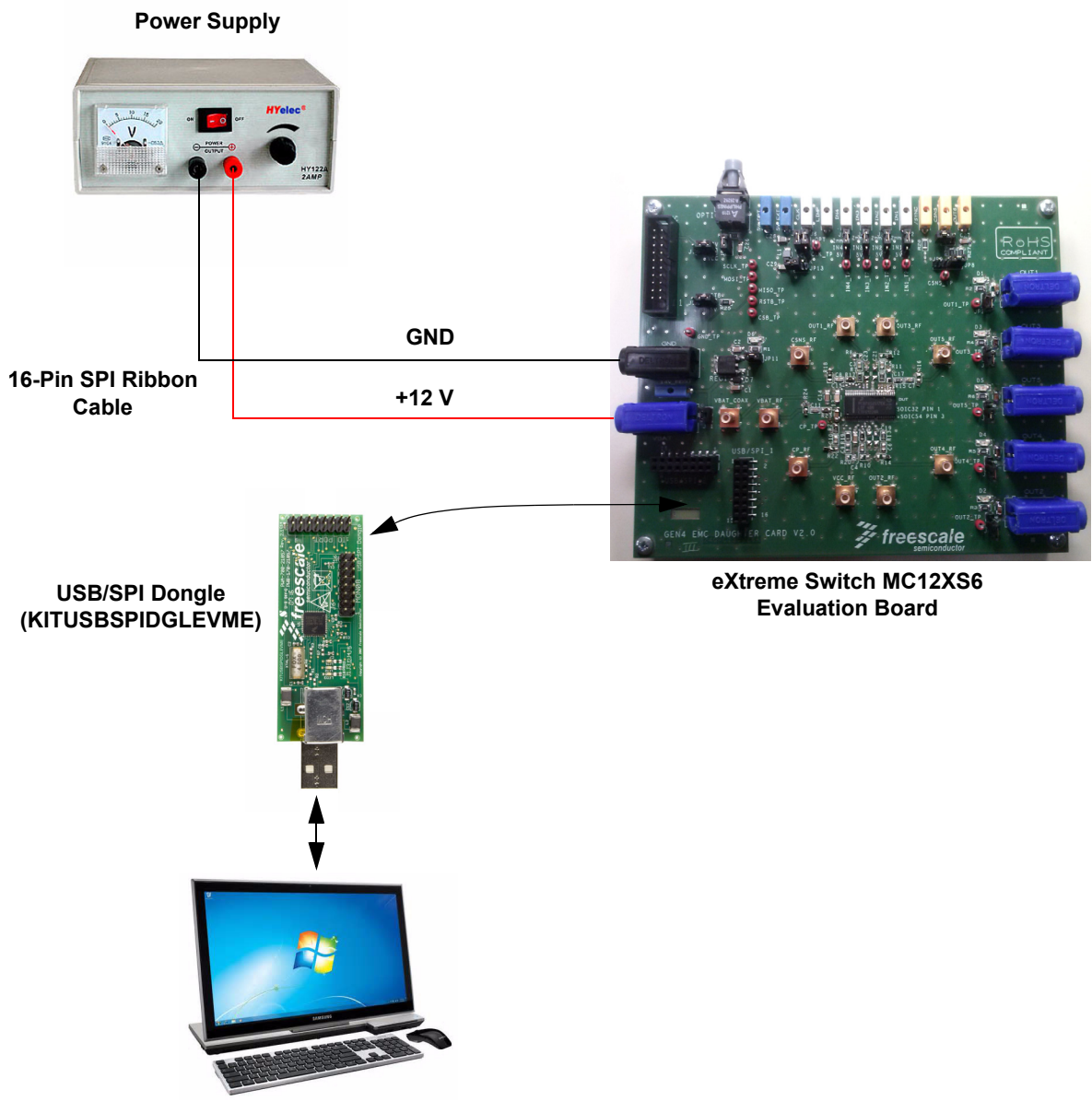

Figure 3. eXtreme Switch MC12XS6 Evaluation Board plus KITUSBSPIDGLEVME Board Setup

10 Installing SPIGen Freeware on your Computer

The latest version of SPIGen is designed to run on any Windows 8, Windows 7, Vista or XP-based operating system. To install the software, go to www.freescale.com/analogtools and select your kit. Click on that link to open the corresponding Tool Summary Page. Look for “Jump Start Your Design”. Download to your computer desktop the SPIGen software as well as the associated configuration file.

Run the install program from the desktop. The Installation Wizard will guide you through the rest of the process.

To use SPIGen, go to the Windows Start menu, then Programs, then SPIGen, and click on the SPIGen icon. The SPIGen Graphic User Interface (GUI) will appear. Go to the file menu in the upper left hand corner of the GUI, and select “Open”. In the file selection window that appears, set the “Files of type:” drop-down menu to “SPIGen Files (*.spi)”. (As an exceptional case, the file name may have a .txt extension, in which case you should set the menu to “All Files (*.*)”). Next, browse for the configuration file you saved on your desktop earlier and select it. Click “Open”, and SPIGen will create a specially configured SPI command generator for your evaluation board.

The GUI is shown in **Figure 4**. The text at the top is the name of the configuration file loaded. The left side panel displays folders that group user interfaces. The process of loading the configuration file has assigned a list of “Extra Pins” as well as a list “Quick Commands”, all of which are board-specific.

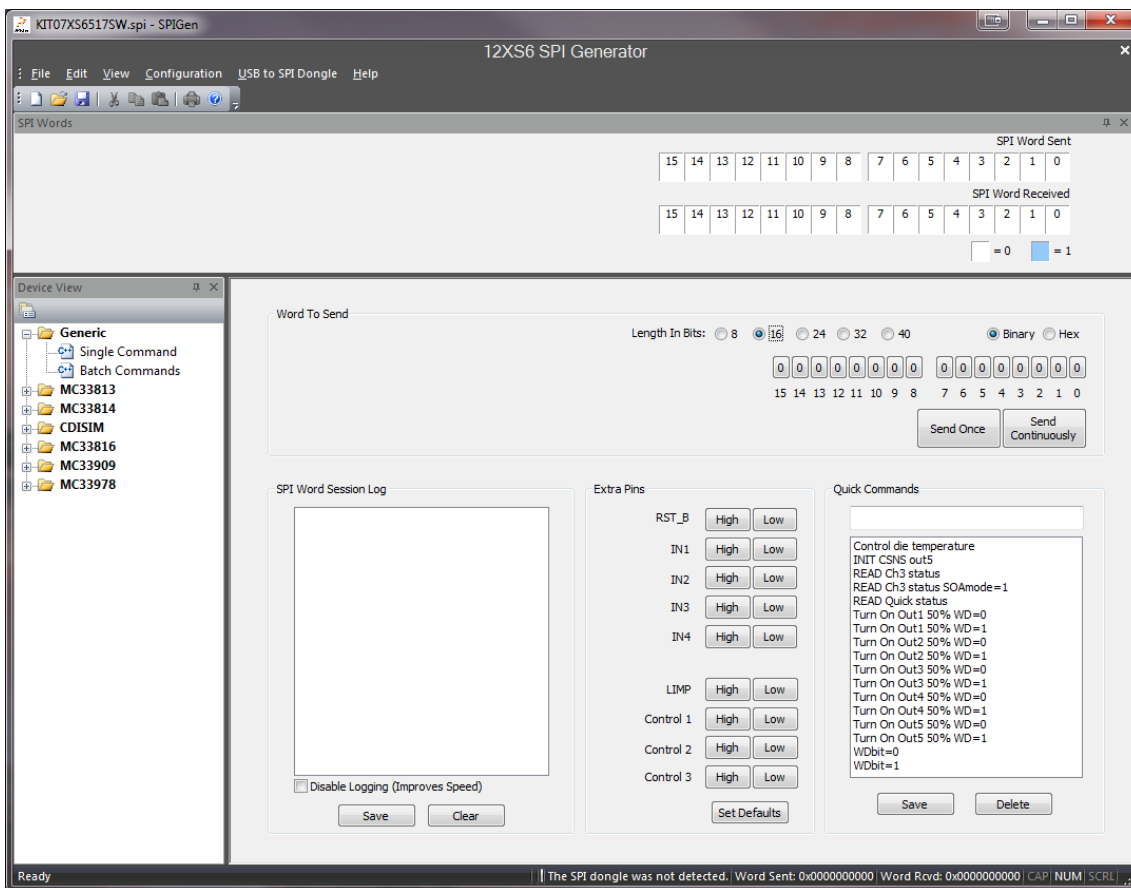

Figure 4. SPIGen GUI

11 Setting Up and Using the Hardware

In order to perform the demonstration examples, first set up the evaluation board hardware and software as follows:

1. Ready the computer and install the latest available version of SPIGen GUI. Then connect the cable between this interface board and computer. Finally, plug this interface board into the eXtreme Switch Gen4 Evaluation Board.
2. Attach a DC power supply (without turning on the power) to evaluation board's V_{PWR} - Gnd connectors and attach loads to the outputs on the board. Plug the USB/SPI interface dongle (KITUSBSPIDGLEVME) directly into the evaluation board.
3. Use as many output terminals as desired.
4. Launch SPIGen and load the GEN4_SPIgen_eval_rev1.spi configuration file obtained from the [Jump Start](#) download.
5. Turn on the power supply with the correct voltage and verify that EVB is supplied correctly by observing the D6 LEDs with JP1 and JP11 closed. J1 and J7 have to be set either to the Vcc or the μ C position. Set all the LED jumpers, JP2 to JP6, to outputs pins; set the "Extra Pin" RST_B (if J1 in uC position) to high on the SPIGen GUI and then do the following verification:
6. Click on the "Extra Pins" button INx. The corresponding OUTx LED should turn on.
7. Click on the "Send Once" button. The 'SPI Word Received' at the top of the screen should answer something different from 0x0000.

Once the steps above are all accomplished, then you are ready to proceed with the remaining examples.

11.1 SPIGen Software information

On the left side of the "device view", you have two options:

- "Single Command": The screen displays 16 bits from the SPI interface, so the user can configure them easily in binary or hexadecimal. You will also find at the top, the corresponding status of SI and SO bits and on bottom left, the "SPI Word Session Log". Extra pins are also available for configuration.
- "Batch Commands" allows the user to create a specific function using commands that already exist.

Note:

- Some commands and batches of commands are already set up in the GEN4_SPIgen_eval_rev1.spi file. You may create and save your own command for specific purposes.
- MC12XS6 devices need a WD toggle on bit D11 to stay in normal mode. The interface board KITUSBSPIDGLEVME is not able to generate and take into account WD bit status. Therefore, when doing your own sequence, you may take this into account, and use the "Send Continuously" button.

12 Evaluation Board Hardware Description

This evaluation board has the capability to demonstrate the functionality of the different devices of the Gen4 family, when either of those devices is mounted on the board as a Device Under Test. Below are shown the DUT connections on the board. The labels displayed in red are accessible to a PC running SPIGen software.

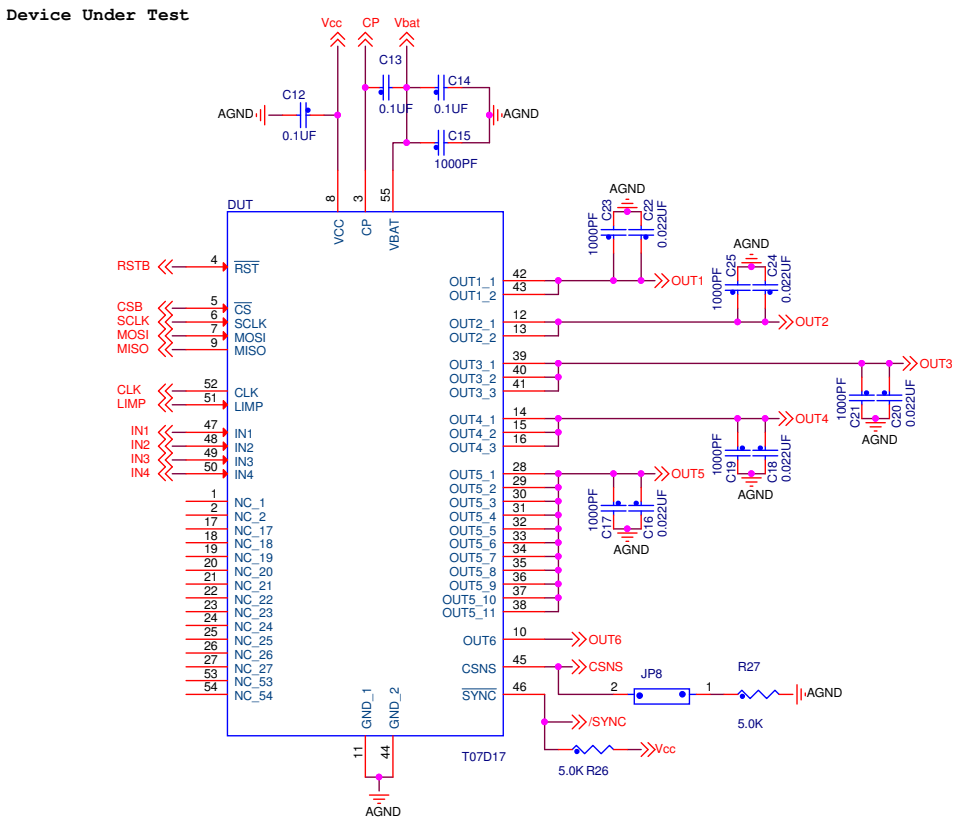

Figure 5. Device Under Test Signals

12.1 LED Display

The following LEDs are provided as visual output devices for the KIT07XS6517EVBE evaluation board:

1. {LED Dx} indicates when the corresponding Outputx is On
2. {LED D6} indicates that Vcc is supplied by the on-board regulator

12.2 Test Point Definitions

Each test point of the board has a label showing its corresponding signal.

12.3 Input Signal Definitions

The MC07XS6517 and the other KITs for the MC12XS6 family have special input signals that are used to control certain outputs or functions inside the circuit. These signals are:

1. {INx} {Control of the corresponding OUTx}
2. {LIMP} {Force the IC into fail-safe mode operation when High}
3. {CLK} {To provide an external clock for PWM}
4. {RSTB} {Wakes up the device}
5. {VCC} {Allows SPI communication}

12.4 Output Signal Definitions

The MC07XS6517, MC17XS6500, and MC40XS6500 ICs have six output signals that are used to connect loads (OUT1 to OUT5) or an additional SMARTPOWER device (OUT6). For the remaining devices, see [Table 3](#) for pin assignment for each part number.

Table 3. MC12XS6 Family Devices

Part Number	Outputs	Output Function	Package	OUT1 Rds(on)	OUT2 Rds(on)	OUT3 Rds(on)	OUT4 Rds(on)	OUT5 Rds(on)	OUT6
MC07XS6517	Penta	Triple 7.0,Dual 17 mΩ	SOIC 54 pins exposed pad	17 mΩ	17 mW	7.0 mW	7.0 mW	7.0 mW	Yes
MC08XS6421	Quad	Dual 8.0, Dual 21 mΩ	SOIC 32 pins exposed pad	21 mΩ	21 mW	8.0 mW	8.0 mW	—	Yes
MC10XS6225	Dual	Single 25, 10 mΩ		25 mΩ	—	10 mW	—	—	Yes
MC10XS6200	Dual	Dual 10 mΩ		—	—	10 mW	10 mW	—	Yes
MC10XS6325	Triple	Single 25, Dual 10 mΩ		25 mΩ	—	10 mW	10 mW	—	Yes
MC17XS6400	Quad	Quad 17 mΩ		17 mΩ	17 mΩ	17 mΩ	17 mΩ	—	Yes
MC17XS6500	Penta	Penta 17 mΩ		17 mΩ	17 mΩ	17 mΩ	17 mΩ	17 mΩ	Yes
MC25XS6300	Triple	Triple 25 mΩ		25 mΩ	25 mW	25 mW	—	—	Yes
MC40XS6500	Penta	Penta 40 mΩ		40 mΩ	40 mW	40 mW	40 mW	40 mW	Yes

12.5 Evaluation Board Connectors

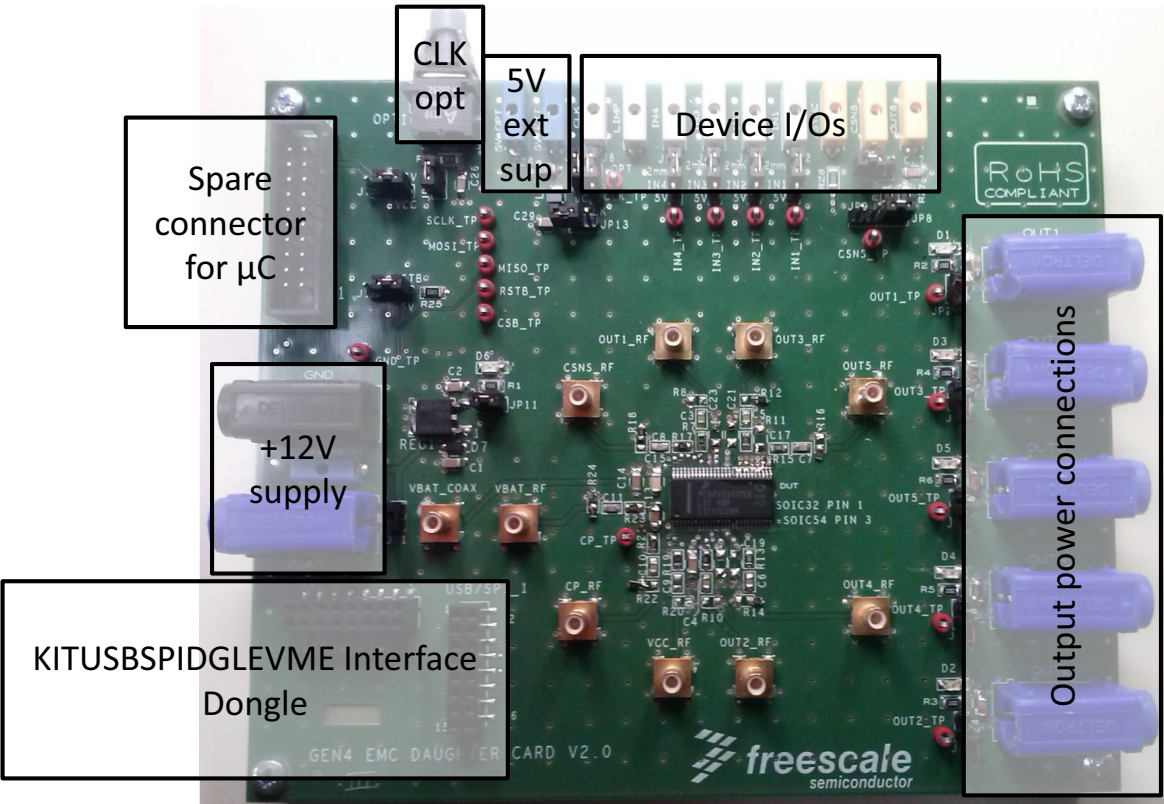

Figure 6. Connector Designations

12.5.1 USB/SPI Dongle Connector

USB/SPI dongle connector mates with the 16-conductor flat cable that connects to the USB/SPI Dongle (KITUSBSPIDGLEVME).

This is a 16 pin, 0.1" center, dual-row connector that is designed to interface directly to the USB/SPI Dongle unit. The USB/SPI dongle connector consists of the following 16 pins.

Table 4. USB/SPI Dongle Pin Description

Pin Number	Name	Description
1	CSB	SPI signal, Chip Select Bar
2	CNTL2	NC
3	SO	SPI signal, Serial Out
4	CNTL1	NC
5	SI	SPI signal, Serial In
6	CNTL0	CNTL0, connected to LIMP
7	SCLK	SPI signal, Serial Clock
8	DATA4	DATA4 connected to IN4
9	CNTL3	NC
10	DATA3	DATA4 connected to IN3
11	VDD	+5.0 Volt VDD from USB
12	DATA2	DATA4 connected to IN2
13	+3.3V	+3.3 V from USB (not used) ⁽¹⁾
14	DATA1	DATA4 connected to IN1
15	GND	Signal Ground
16	DATA0	DATA0, connected to RST_B

Notes

1. This connection is unused for this evaluation board.

The following table defines the evaluation board jumper positions and explains their functions. (The default settings are shown in bold.)

Table 5. Jumper Table

Jumper	Description	Setting	Connection
J1, J7	/RSTB & Vcc connection to 5 V	1-2	Connected to 5 V regulator
		2-3	Connected to SPIgen connector
J2-J5	IN1-IN4 connection to 5 V	1-2	Connected to white banana IN1-IN4
		2-3	Connected to 5 V regulator
J6	CLK connection	1-2	Connected to white banana CLK
		2-3	Connected to CON2x10
JP1	5 V regulator connection	1-2	Connect Vbat to regulator Vin
JP2-JP6	Witness LED of each output status	1-2	Connect the output to LED through resistor
JP7	External Clock via optical interface	1-2	Connect J6(2-3) to optical interface
JP8	CSNS load connection	1-2	Connect CSNS to 5k resistor
JP9	CSNS external connection	1-2	Route CSNS externally through banana
JP10	CSNS filtered external connection	1-2	Route filtered CSNS signal externally through banana
JP11	5 V supply witness LED	1-2	Connect regulator output to LED through resistor
JP12	Optical interface 5 V connection	1-2	Connect optical interface to 5 V regulator
JP13	Filtered Vcc connection	1-2	Connect IC's VCC to a PI-filtered 5 V supply

13 Schematic

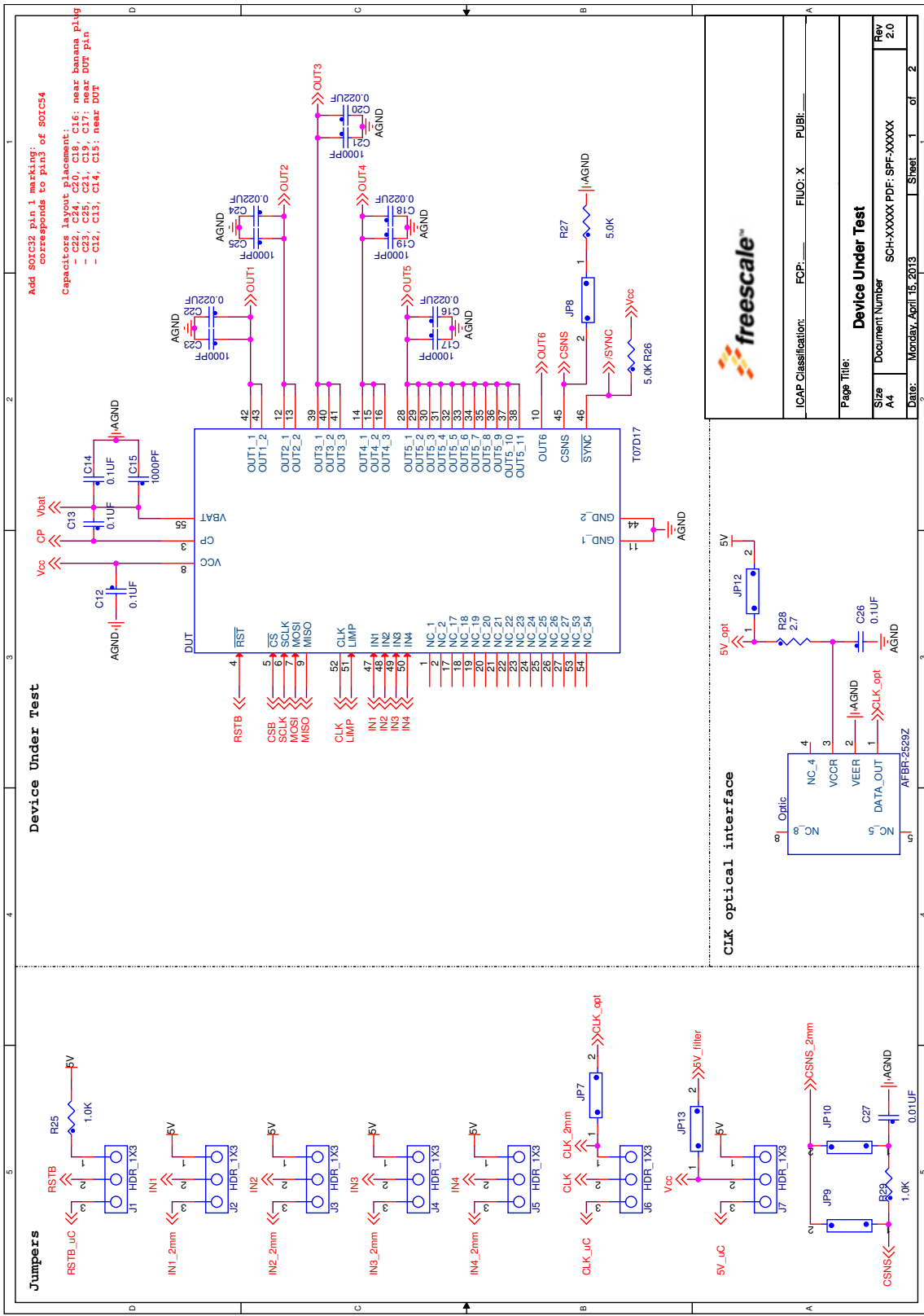

Figure 7. Evaluation Board Schematic, Part 1

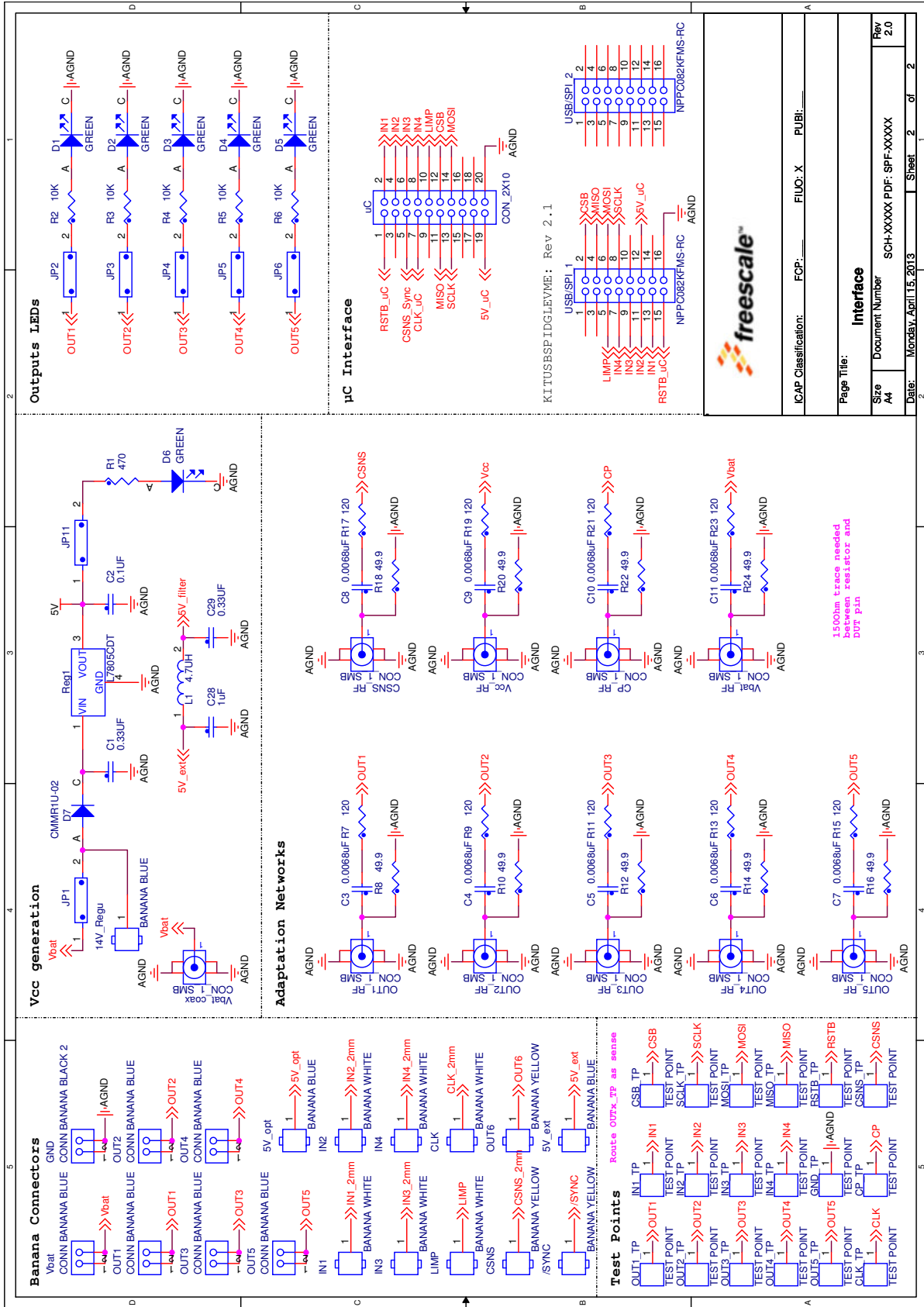
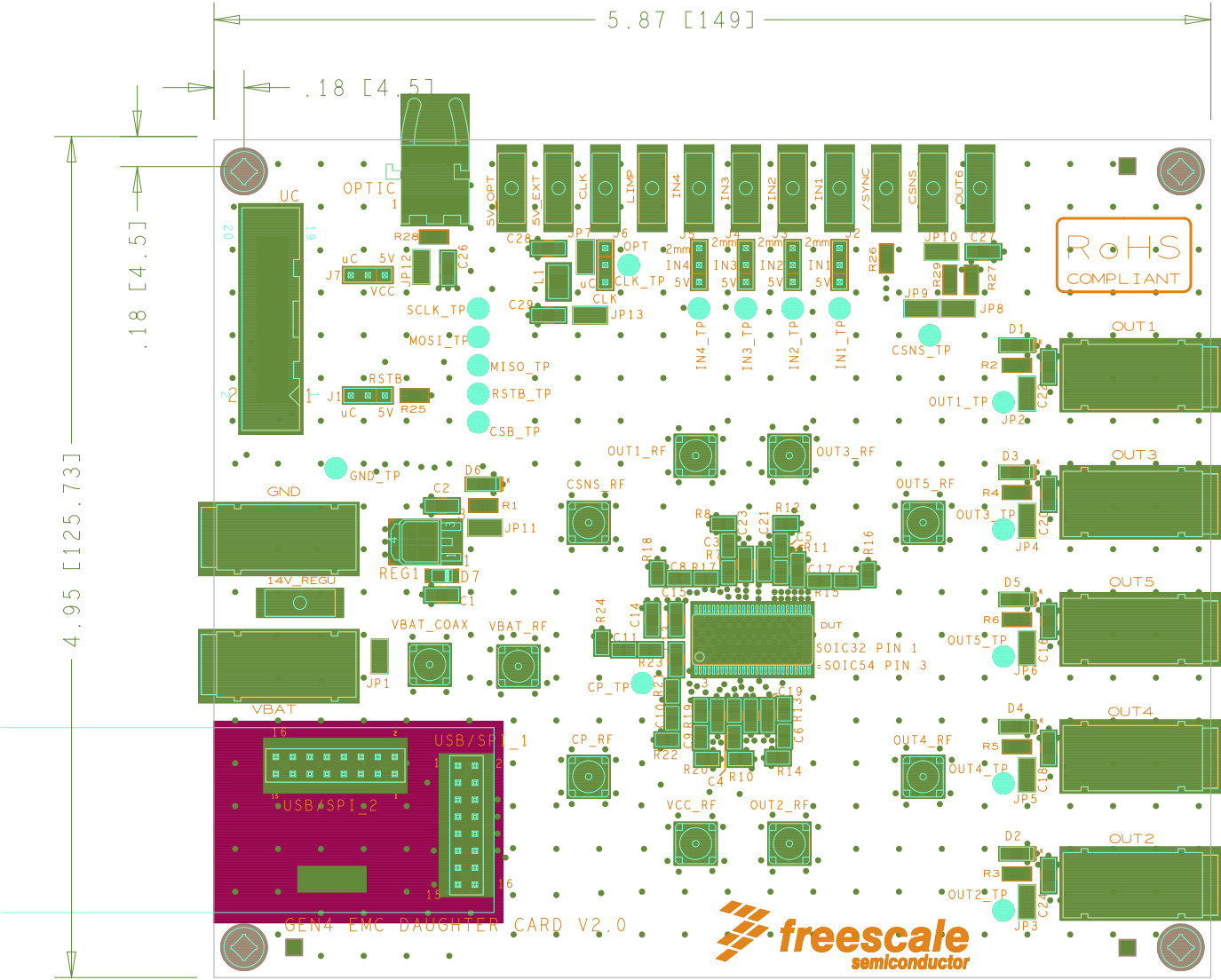

Figure 8. Evaluation Board Schematic, Part 2

14 Board Layout

14.1 Assembly Layer Top



14.2 Top Layer Routing

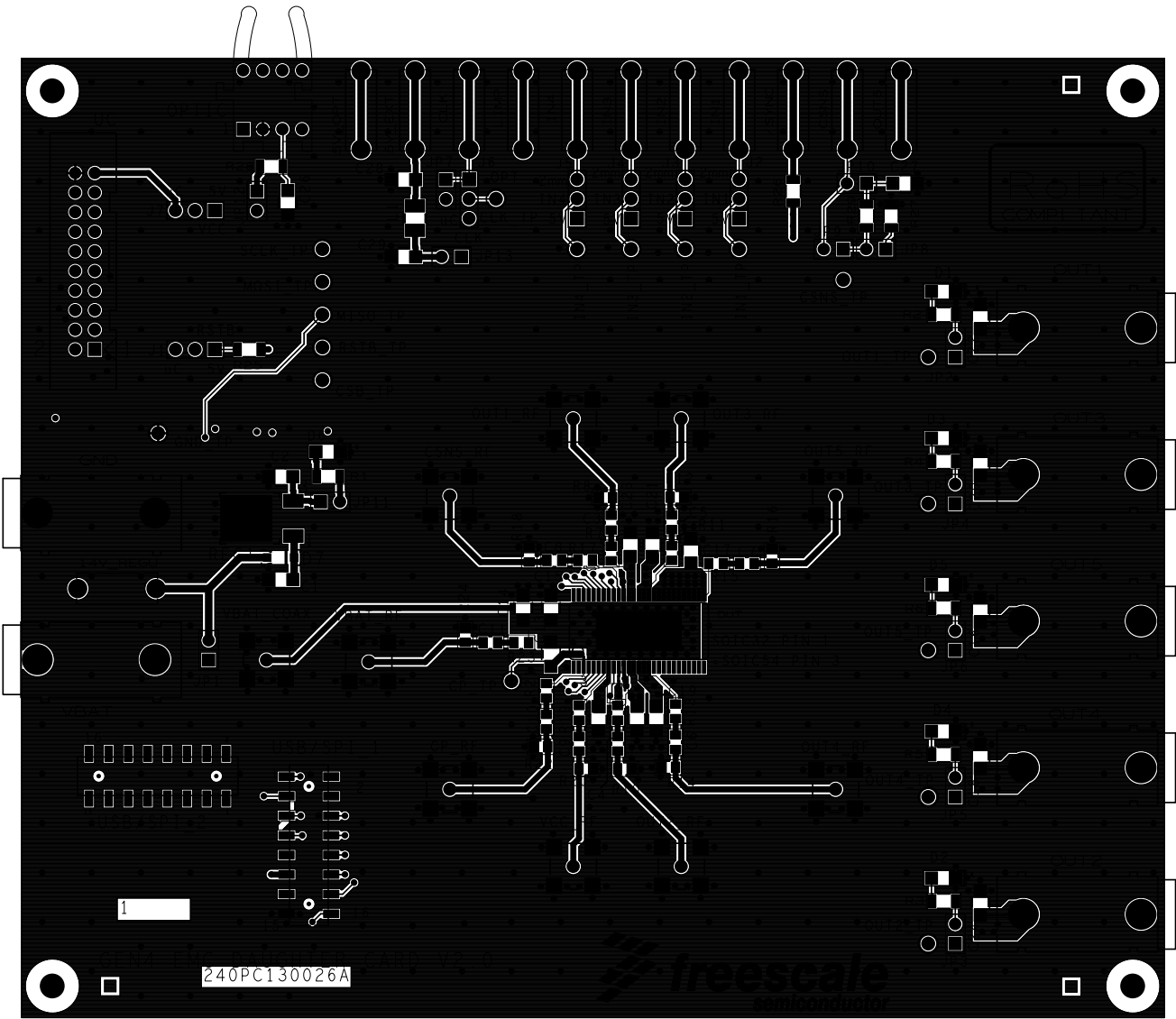

14.3 Inner Layer 1 Routing

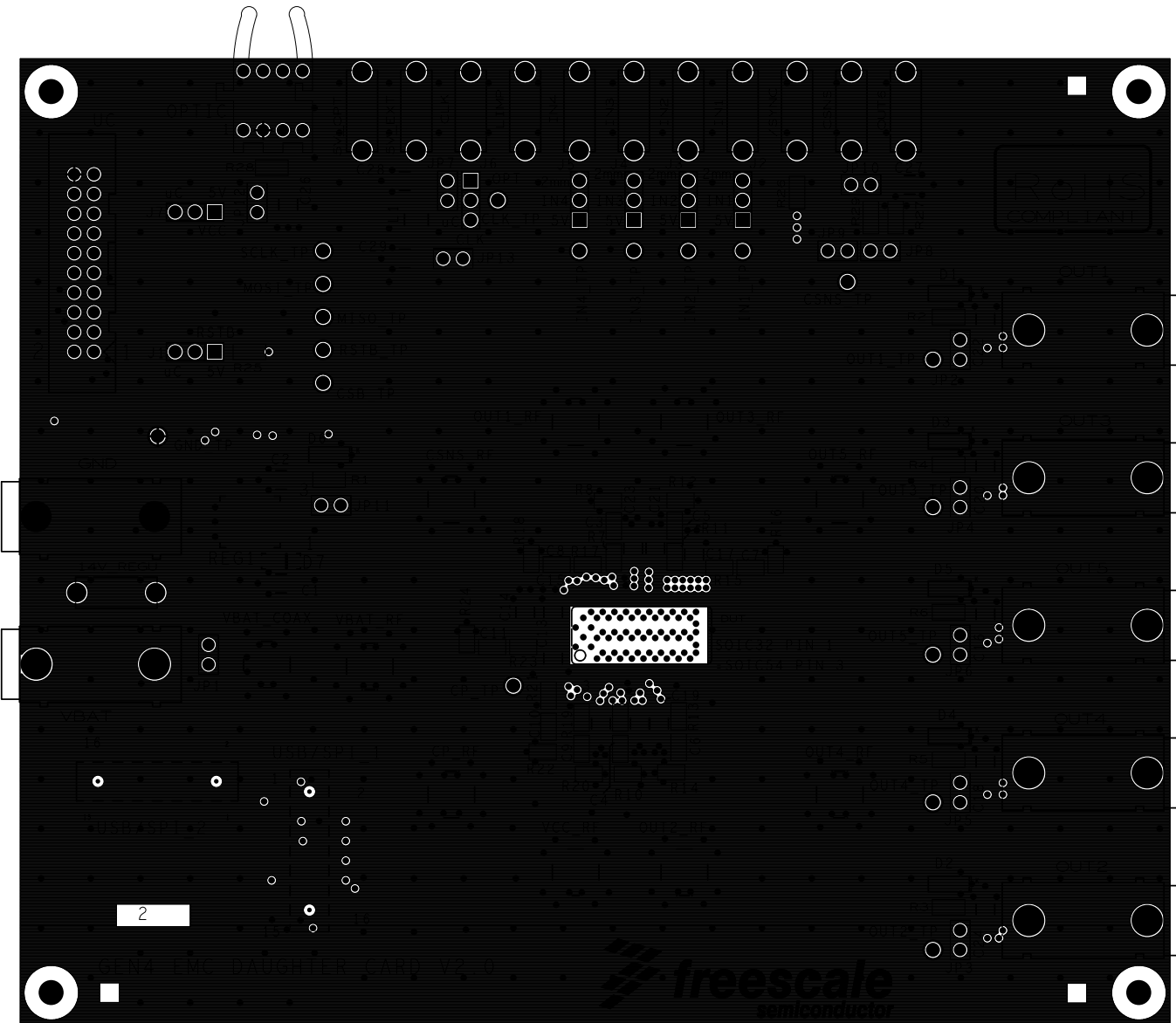

14.4 Inner Layer 2 Routing

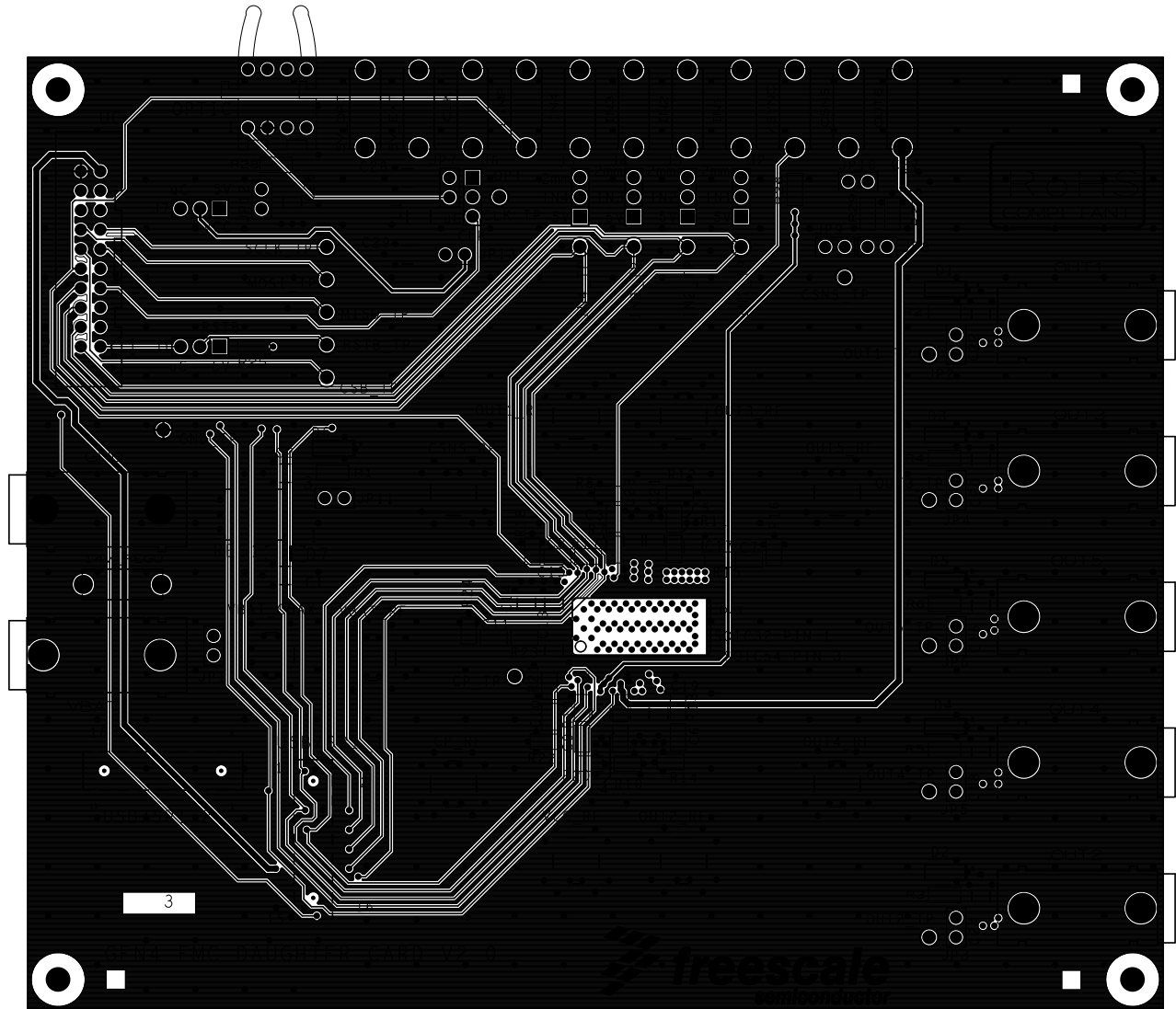

14.5 Bottom Layer Routing

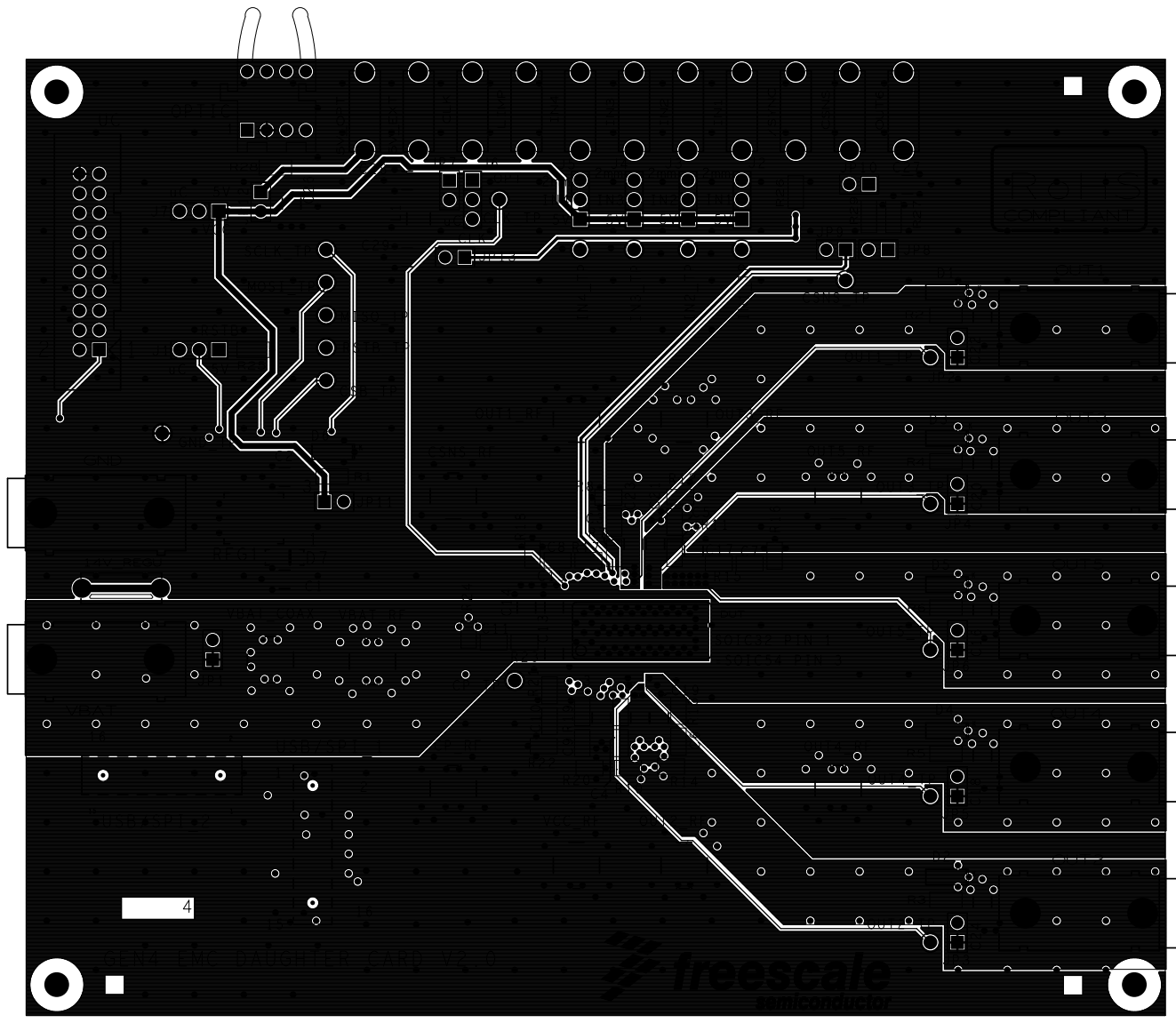

14.6 Drill Location

DRILL CHART: TOP to BOTTOM
ALL UNITS ARE IN MILLIMETERS

FIGURE	SIZE	PLATED	QTY
+	0.3	PLATED	712
□	0.8	PLATED	8
⊕	1.0	PLATED	64
□	1.1	PLATED	21
○	1.3	PLATED	24
◦	2.2	PLATED	14
▲	1.1	NON-PLATED	4
⊙	3.2	NON-PLATED	4

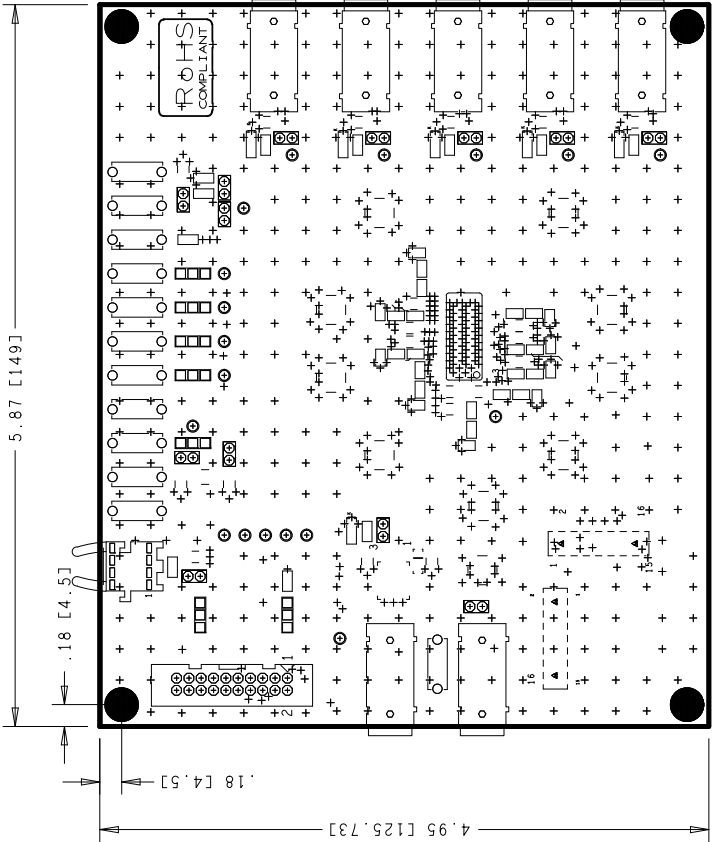

15 Bill of Materials

Table 6. Bill of Materials (2)

Schematic Label	Qty	Value	Description	Package	Assy. Opt.
Integrated Circuits					
DUT	1		Freescale MC07XS6517EK	54-pin SOICEP	(3)
			Freescale MC17XS6500EK	32-pin SOICEP	
			Freescale MC08XS6421EK		
			Freescale MC17XS6400EK		
			Freescale MC40XS6500EK		
			Freescale MC25XS6300EK		
			Freescale MC10XS6200EK		
			Freescale MC10XS6225EK		
Optic	1		Avago AFBR-2529Z,IC RCVR 50MBD 3.3/5V 20MA TH	hfbr_1521	
Inductors					
L1	1	4.7 μ H	IND CHK 4.7UH@1MHZ 650mA 20%	SMD 1210	
Diodes					
D7	1		DIODE RECT 1A 200V	SOD-123F	
LEDs					
D1, D2, D3, D4, D5, D6	6		LED GRN SGL 20mA SMT	SMD 1206	
Capacitors					
C1, C29	2	330 nF	CAP CER 0.33 μ F 50V 10% X7R	SMD 1206	
C2	1	100 nF	CAP CER 0.1 μ F 50V 10% X7R	SMD1206	
C3...C11	9	6.8 nF	CAP CER 0.0068 μ F 50V 10% X7R	SMD0805	
C12, C13, C14, C26	4	100 nF	CAP CER 0.1 μ F 200V 10% X7R	SMD1206	
C15, C17, C19, C21, C23, C25	6	1.0 nF	CAP CER 1000pF 2000V +80%/-20% X7R	SMD1206	
C16, C18, C20, C22, C24	5	22 nF	CAP CER 0.022 μ F 50V 5% X7R	SMD1206	
C27	1	10 nF	CAP CER 0.01 μ F 100V 5% X7R	SMD1206	
C28	1	1.0 μ F	CAP CER 1 μ F 50V 10% X7R	SMD 1206	
Regulator					
Reg1	1	5.0 V	IC VREG 5V 1.5A 35V DPAK	to252_dpak_st	
Resistors					
R1	1	470	RES MF 470 OHM 1/4W 5%	SMD 1206	
R2, R3, R4, R5, R6	5	10 k	RES MF 10K 1/4W 5%	SMD 1206	
R7, R9, R11, R13, R15, R17, R19, R21, R23	9	120	RES MF 120 OHM 1/8W 5%	SMD 0805	

Table 6. Bill of Materials (continued) (2)

Schematic Label	Qty	Value	Description	Package	Assy. Opt.
R8, R10, R12, R14, R16, R18, R20, R22, R24	9	49.9	RES MF 49.9 OHM 1/8W 1%	SMD 0805	
R25	1	1.0 k	RES MF 1.0K 1/4W 5%	SMD 1206	
R26, R27	2	5.0 k	RES MF 5.00K 1/4W 0.1%	SMD 1206	
R28	1	2.70	RES MF 2.70 OHM 1/4W 1%	SMD 1206	
R29	1	1.0 k	RES MF 1.00K 1/4W 1%	SMD 1206	

Switches, Connectors, Jumpers and Test Points

CLK, IN1-IN4, LIMP	6		CON 1 BANANA RA TH -- 203H AG WHITE		
CLK_TP, CP_TP, CSB_TP, CSNS_TP, GND_TP, IN1_TP, IN2_TP, IN3_TP, IN4_TP, MISO_TP, MOSI_TP, OUT1_TP, OUT2_TP, OUT3_TP, OUT4_TP, OUT5_TP, RSTB_TP, SCLK_TP	18		TEST POINT RED PAD C100-55T TH		
5V_EXT, 5V_OPT, 14V_Regu	2		CON 1 BANANA RA TH -- 203H AG BLUE		
/SYNC, CSNS, OUT6	3		CON 1 BANANA RA TH -- 203H AG YELLOW		
VBAT, OUT1...OUT5	6		CON 1X2 BANANA RA TH 15.3MM SP 488H AG BLUE 197L		
GND	1		CON 1X2 BANANA RA TH 15.3MM SP 488H AG BLACK 197L		
JP1...13	13		CON 2 JUMPER MALE 2.54MM		
J1...J7	7		HDR 1X3 TH 100MIL SP 374H AU		
CP_RF, CSNS_RF, OUT1_RF, OUT2_RF, OUT3_RF, OUT4_RF, OUT5_RF, VBAT_RF, VBAT_COAX, VCC_RF	10		CON 1 COAX SMB SMT -- 291H AU	con_smb_6p3sq	
USB/SPI_1, USB/SPI_2	2		HDR 2X8 SKT SMT 100MIL CTR 305H AU		
UC			CON 2X10 PLUG SHRD TH 100MIL CTR 380H AU	HDR210_4w	

Notes

2. Freescale does not assume liability, endorse, or warrant components from external manufacturers that are referenced in circuit drawings or tables. While Freescale offers component recommendations in this configuration, it is the customer's responsibility to validate their application.
3. Critical Components. For critical components, it is vital to use the manufacturer listed.

16 References

Following are URLs where you can obtain information on related Freescale products and application solutions:

Freescale.com Support Pages	Description	URL
MC12XS6	Product Summary Page	http://www.freescale.com/webapp/sps/site/prod_summary.jsp?code=MC12XS6
KITUSBSPIDGLEVME	Tool Summary Page	http://www.freescale.com/webapp/sps/site/prod_summary.jsp?code=KITUSBSPIDGLEVME
SPIGen	Tool Summary Page	http://www.freescale.com/files/soft_dev_tools/software/device_drivers/SPIGen.html
Analog	Home Page	http://www.freescale.com/analog
Automotive	Home Page	http://www.freescale.com/automotive

16.1 Support

Visit www.freescale.com/support for a list of phone numbers within your region.

16.2 Warranty

Visit www.freescale.com/warranty for a list of phone numbers within your region.

17 Revision History

Revision	Date	Description of Changes
1.0	11/2013	<ul style="list-style-type: none"> Initial Release
2.0	4/2014	<ul style="list-style-type: none"> Added in all other 12XS6 family devices Updated format to accomodate device additions Changed the Document ID from KTXSWITCH4UG to KT12XS6UG
	7/2014	<ul style="list-style-type: none"> Adjusted format Added sentence to describe Table 1

How to Reach Us:

Home Page:
freescale.com

Web Support:
freescale.com/support

Information in this document is provided solely to enable system and software implementers to use Freescale products. There are no express or implied copyright licenses granted hereunder to design or fabricate any integrated circuits based on the information in this document.

Freescale reserves the right to make changes without further notice to any products herein. Freescale makes no warranty, representation, or guarantee regarding the suitability of its products for any particular purpose, nor does Freescale assume any liability arising out of the application or use of any product or circuit, and specifically disclaims any and all liability, including without limitation consequential or incidental damages. "Typical" parameters that may be provided in Freescale data sheets and/or specifications can and do vary in different applications, and actual performance may vary over time. All operating parameters, including "typicals," must be validated for each customer application by customer's technical experts. Freescale does not convey any license under its patent rights nor the rights of others. Freescale sells products pursuant to standard terms and conditions of sale, which can be found at the following address: freescale.com/SalesTermsandConditions.

Freescale and the Freescale logo are trademarks of Freescale Semiconductor, Inc., Reg. U.S. Pat. & Tm. Off. SMARTMOS is a trademark of Freescale Semiconductor, Inc. All other product or service names are the property of their respective owners.

© 2014 Freescale Semiconductor, Inc.

Document Number: KT12XS6UG
Rev. 2.0
7/2014