

**YELLOW GMA 8475C GMC 8475C
HER GMA 8875C GMC 8875C
GREEN GMA 8975C GMC 8975C
BICOLOR- RED/GREEN GMA 8675C GMC 8675C**

PACKAGE DIMENSIONS

A. GMX8X75C

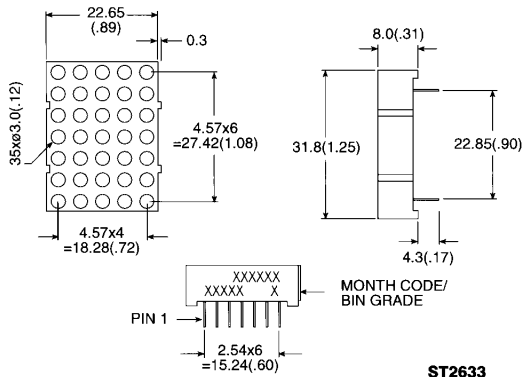

B. GMX8675C

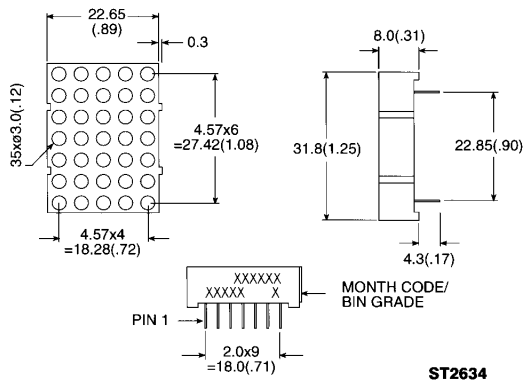

DESCRIPTION

The GMX8X75C series are 1.2" (30 mm) matrix height 5 × 7 dot matrix displays. All these parts are available in gray face and white dot color.

The X in GMX denotes row anode or row cathode.

FEATURES

- 1.2" (30 mm) matrix height
- Choice of 3 colors — green, yellow & HER and bicolor — red/green
- Low power consumption
- 5 × 7 array with X-Y select
- Stackable horizontally
- Choice of 2 matrix orientation cathode column or anode column
- Easy mounting or PCB on sockets
- Categorized for luminous intensity
- Multicolor color displays are applicable to 3 bright colors — green, orange (HER) and yellow (green and HER mixed)

NOTES:

1. ALL PINS ARE Ø0.5 (.02).
2. DIMENSIONS IN MILLIMETER (INCH), TOLERANCE IS ±0.25 (.01) UNLESS OTHERWISE NOTED.



**1.2" 5 x 7
DOT MATRIX DISPLAYS**

ABSOLUTE MAXIMUM RATING (T _A = 25°C unless otherwise specified)				
PARAMETER	YELLOW	HER	GREEN	UNITS
Power dissipation per dot	60	70	75	mW
Peak forward current per dot (Duty cycle 1/10, 10KHz)	80	100	100	mA
Continuous I _F per dot	20	5	25	mA
Reverse voltage per dot	5	5	5	V
Operating and storage temperature range	-25°C to +85°C			
Soldering time at 260°C (1/16 inch below seating plane)	3 sec			

MODEL NUMBERS						
PART NO.				DESCRIPTION	PACKAGE DIMENSION	INTERNAL CIRCUIT DIAGRAM
YELLOW	HER	GREEN	MULTI-COLOR			
GMC8475C	GMC8875C	GMC8975C		Anode column, cathode row	A	A
GMA8475C	GMA8875C	GMA8975C		Cathode column, anode row	A	B
			GMA8675C	Cathode column, anode row	B	C
			GMC8675C	Anode column, cathode row	B	D

ELECTRICAL/OPTICAL CHARACTERISTICS ($T_A = 25^\circ\text{C}$ Unless otherwise specified)
GMX8475C (YELLOW)

PARAMETER	MIN.	TYP.	MAX.	UNITS	TEST CONDITIONS
Average luminous intensity		3000		μcd	$I_f = 20\text{ mA}$
Peak emission wavelength		585		nm	$I_f = 20\text{ mA}$
Spectral line half-width		35		nm	$I_f = 20\text{ mA}$
Forward voltage, any dot		2.1	2.8	V	$I_f = 20\text{ mA}$
Reverse voltage, any dot			100	μA	$V_R = 5\text{ V}$

TYPICAL ELECTRICAL/OPTICAL CHARACTERISTIC CURVES
($T_A = 25^\circ\text{C}$ Unless otherwise specified)

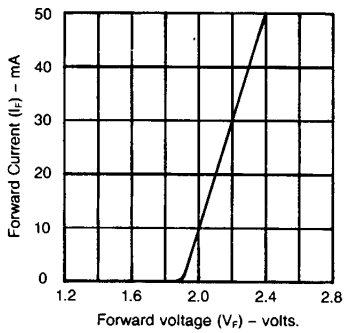

C3037

Fig. 1. Forward Current vs. Forward Voltage

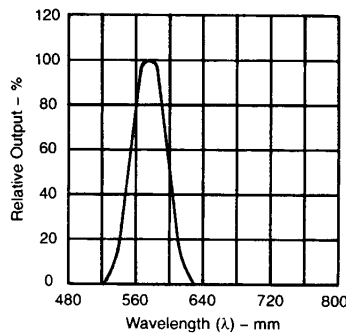

C3038

Fig. 2. Spectral Response

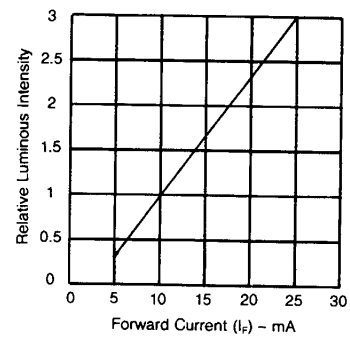

C3039

Fig. 3. Relative Luminous Intensity vs. Forward Current (Per Segment)

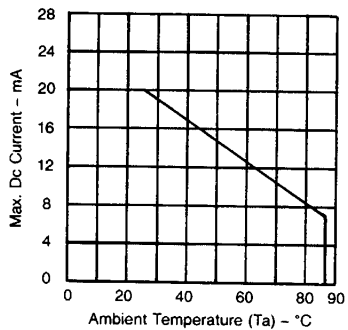

C3040

Fig. 4. Maximum Forward Allowable DC Current Per Segment vs. Ambient Temperature

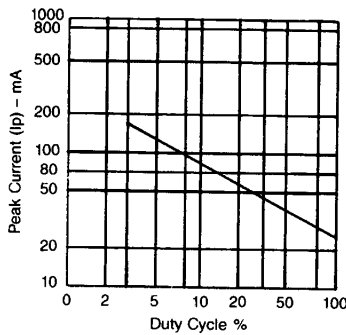

C3041

Fig. 5. Max Peak Current vs. Duty Cycle %
(Refresh Rate $f = 1\text{ KHz}$)

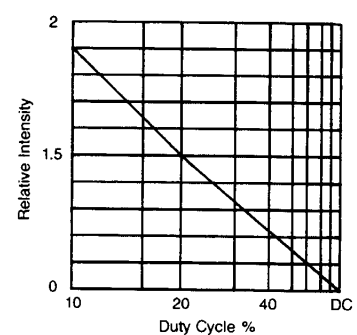

C3042

Fig. 6. Luminous Intensity vs. Duty Cycle %
(Average $I = 10\text{ mA}$ Per Seg.)

ELECTRICAL/OPTICAL CHARACTERISTICS ($T_A = 25^\circ\text{C}$ Unless otherwise specified)					
GMX8875C (HER)					
PARAMETER	MIN.	TYP.	MAX.	UNITS	TEST CONDITIONS
Average luminous intensity		3000		μcd	$I_F = 20\text{ mA}$
Peak emission wavelength		635		nm	$I_F = 20\text{ mA}$
Spectral line half-width		30		nm	$I_F = 20\text{ mA}$
Forward voltage, any dot		2.1	2.8	V	$I_F = 20\text{ mA}$
Reverse voltage, any dot			100	μA	$V_R = 5\text{ V}$

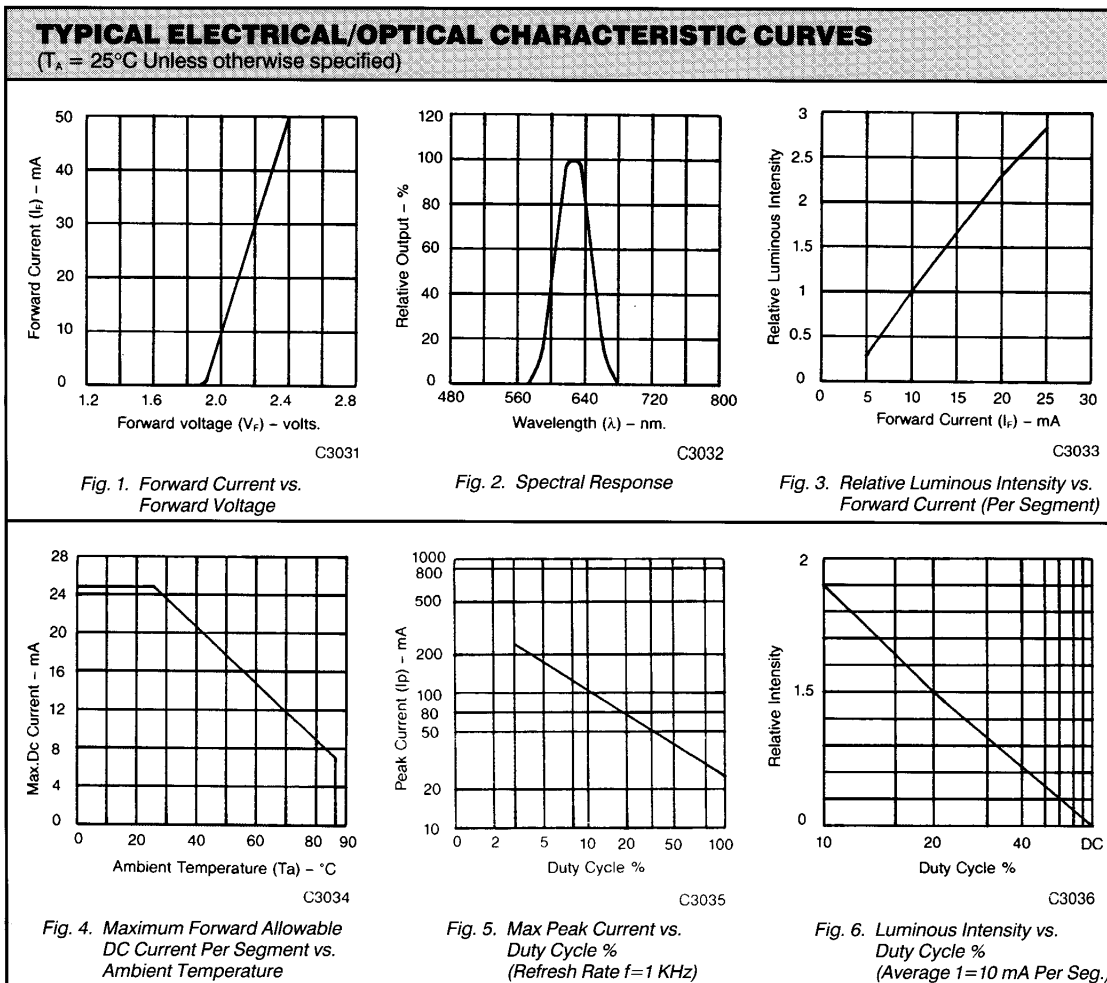

ELECTRICAL/OPTICAL CHARACTERISTICS ($T_A = 25^\circ\text{C}$ Unless otherwise specified)
GMX8975C (GREEN)

PARAMETER	MIN.	TYP.	MAX.	UNITS	TEST CONDITIONS
Average luminous intensity		3000		μcd	$I_f = 20 \text{ mA}$
Peak emission wavelength		565		nm	$I_f = 20 \text{ mA}$
Spectral line half-width		30		nm	$I_f = 20 \text{ mA}$
Forward voltage, any dot		2.1	2.8	V	$I_f = 20 \text{ mA}$
Reverse voltage, any dot			100	μA	$V_R = 5 \text{ V}$

TYPICAL ELECTRICAL/OPTICAL CHARACTERISTIC CURVES

($T_A = 25^\circ\text{C}$ Unless otherwise specified)

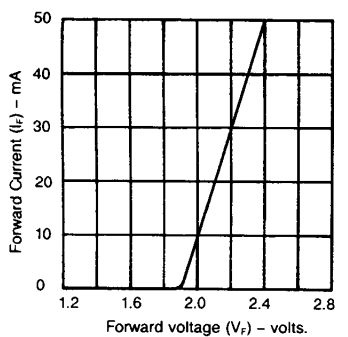

C3043

Fig. 1. Forward Current vs. Forward Voltage

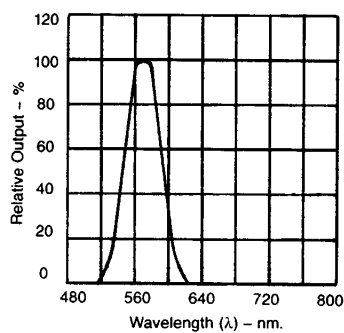

C3044

Fig. 2. Spectral Response

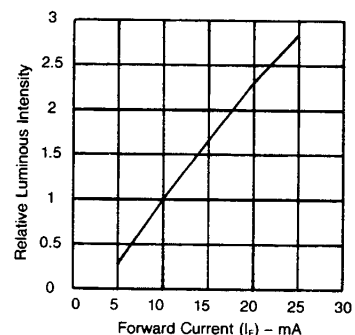

C3045

Fig. 3. Relative Luminous Intensity vs. Forward Current (Per Segment)

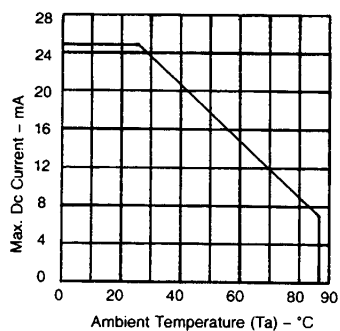

C3046

Fig. 4. Maximum Forward Allowable DC Current Per Segment vs. Ambient Temperature

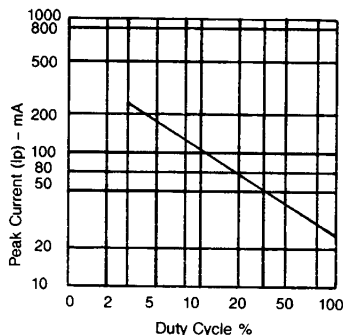

C3047

Fig. 5. Max Peak Current vs. Duty Cycle % (Refresh Rate $f = 1 \text{ KHz}$)

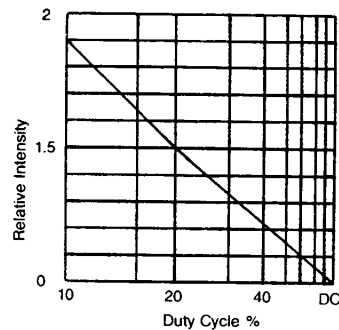

C3048

Fig. 6. Luminous Intensity vs. Duty Cycle % (Average $I = 10 \text{ mA}$ Per Seg.)

PIN CONNECTION				
PIN NO.	GMA8X75C	GMC8X75C	GMC8675C	GMA8675C
1	Anode row 5	Cathode row 5	Cathode row 7 green	Anode row 7 green
2	Anode row 7	Cathode row 7	Cathode row 7 HER	Anode row 7 HER
3	Cathode column 2	Anode column 2	Anode column 1	Cathode column 1
4	Cathode column 3	Anode column 3	Anode column 2	Cathode column 2
5	Anode row 4	Cathode row 4	Anode column 3	Cathode column 3
6	Cathode column 5	Anode column 5	Anode column 4	Cathode column 4
7	Anode row 6	Cathode row 6	Anode column 5	Cathode column 5
8	Anode row 3	Cathode row 3	Cathode row 6 green	Anode row 6 green
9	Anode row 1	Cathode row 1	Cathode row 6 HER	Anode row 6 HER
10	Cathode column 4	Anode column 4	No connection	No connection
11	Cathode column 3	Anode column 3	Cathode row 5 green	Anode row 5 green
12	Anode row 4	Cathode row 4	Cathode row 5 HER	Anode row 5 HER
13	Cathode column 1	Anode column 1	Cathode row 4 green	Anode row 4 green
14	Anode row 2	Cathode row 2	Cathode row 4 HER	Anode row 4 HER
15			Cathode row 3 green	Anode row 3 green
16			Cathode row 3 HER	Anode row 3 HER
17			Cathode row 2 green	Anode row 2 green
18			Cathode row 2 HER	Anode row 2 HER
19			Cathode row 1 green	Anode row 1 green
20			Cathode row 1 HER	Anode row 1 HER

INTERNAL CIRCUIT DIAGRAM

A. GMC8X75C

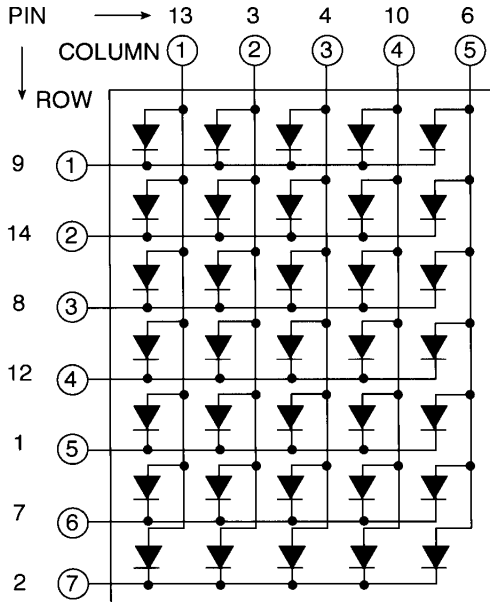

B. GMA8X75C

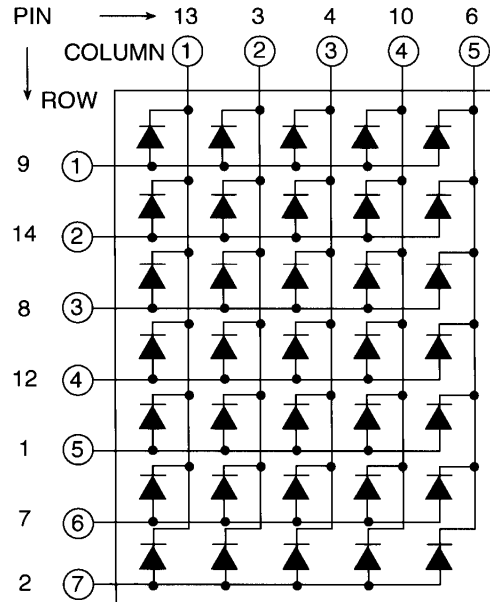

C. GMA8675C

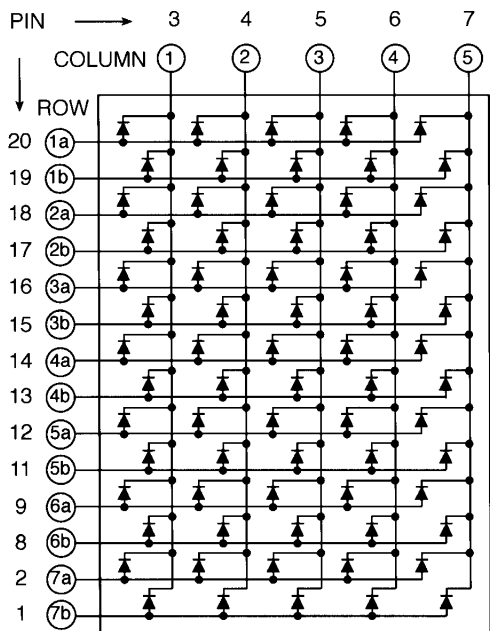

D. GMC8675C

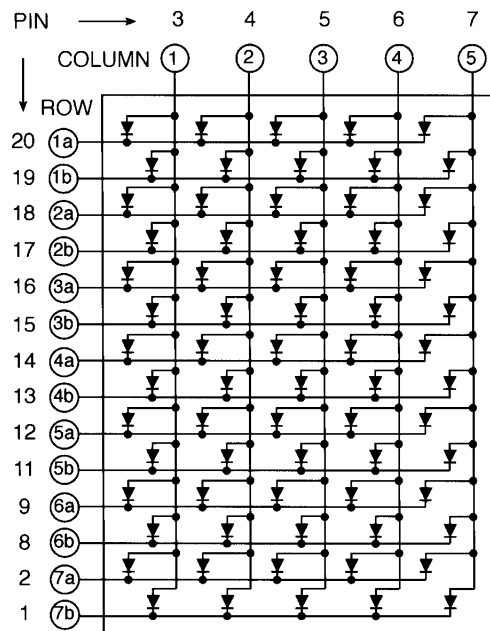



1.2" 5 X 7
DOT MATRIX DISPLAYS

DISCLAIMER

FAIRCHILD SEMICONDUCTOR RESERVES THE RIGHT TO MAKE CHANGES WITHOUT FURTHER NOTICE TO ANY PRODUCTS HEREIN TO IMPROVE RELIABILITY, FUNCTION OR DESIGN. FAIRCHILD DOES NOT ASSUME ANY LIABILITY ARISING OUT OF THE APPLICATION OR USE OF ANY PRODUCT OR CIRCUIT DESCRIBED HEREIN; NEITHER DOES IT CONVEY ANY LICENSE UNDER ITS PATENT RIGHTS, NOR THE RIGHTS OF OTHERS.

LIFE SUPPORT POLICY

FAIRCHILD'S PRODUCTS ARE NOT AUTHORIZED FOR USE AS CRITICAL COMPONENTS IN LIFE SUPPORT DEVICES OR SYSTEMS WITHOUT THE EXPRESS WRITTEN APPROVAL OF THE PRESIDENT OF FAIRCHILD SEMICONDUCTOR CORPORATION. As used herein:

1. Life support devices or systems are devices or systems which, (a) are intended for surgical implant into the body, or (b) support or sustain life, and (c) whose failure to perform when properly used in accordance with instructions for use provided in the labeling, can be reasonably expected to result in a significant injury of the user.
2. A critical component in any component of a life support device or system whose failure to perform can be reasonably expected to cause the failure of the life support device or system, or to affect its safety or effectiveness.