

MAXIM

1.2 μ A Max, Single/Dual/Quad, Single-Supply Op Amps

General Description

The MAX406/MAX407/MAX409/MAX417-MAX419 are single, dual, and quad low-voltage, micropower, precision op amps designed for battery-operated systems. They feature a supply current of less than 1.2 μ A per amplifier that is relatively constant over the entire supply range, which represents a 15 to 20 times improvement over industry-standard micropower op amps. A unique output stage enables these op amps to operate at ultra-low supply current while maintaining linearity under loaded conditions. In addition, the output is capable of sourcing 1.8mA when powered by a 9V battery.

The common-mode input-voltage range extends from the negative rail to within 1.1V of the positive supply (for the singles, 1.2V for the duals and quads), and the output stage swings rail-to-rail. The entire family is designed to maintain good DC characteristics over the operating temperature range, minimizing the input referred errors.

The MAX406 is a single op amp with two modes of operation: compensated mode and decompensated mode. Floating BW (pin 8) or connecting it to V- internally compensates the amplifier. In this mode, the MAX406 is unity-gain stable with a 5V/ms typical slew rate and an 8kHz gain bandwidth. Connecting BW to V+ puts the MAX406 into decompensated mode with a 20V/ms typical slew rate and a 40kHz gain bandwidth ($A_{VCL} \geq 2V/V$).

The dual MAX407 and quad MAX418 are internally compensated to be unity-gain stable. The MAX409/MAX417/MAX419 single/dual/quad op amps feature 150kHz typical bandwidth, 75V/ms slew rate, and stability for gains of 10V/V or greater.

Applications

Battery-Powered Systems
 Medical Instruments
 Electrometer Amplifiers
 Intrinsically Safe Systems
 Photodiode Pre-Amps
 pH Meters

Features

- ◆ 1.2 μ A Max Quiescent Current per Amplifier
- ◆ +2.5V to +10V Single-Supply Range
- ◆ 500 μ V Max Offset Voltage (MAX406A/MAX409A)
- ◆ < 0.1pA Typical Input Bias Current
- ◆ Output Swings Rail-to-Rail
- ◆ Input Voltage Range Includes Negative Rail

Selection Table

| PART NUMBER | NO. OF AMPLIFIERS | GAIN-BW PRODUCT (kHz, TYP) | GAIN STABILITY (V/V) | OFFSET VOLTAGE (mV, MAX) |
|-------------|-------------------|----------------------------|----------------------|--------------------------|
| MAX406A | 1 | 8*/40** | 1*/2** | 0.5 |
| MAX406B | 1 | 8*/40** | 1*/2** | 2.0 |
| MAX407 | 2 | 8 | 1 | 3.0 |
| MAX409A | 1 | 150 | 10 | 0.5 |
| MAX409B | 1 | 150 | 10 | 2.0 |
| MAX417 | 2 | 150 | 10 | 3.0 |
| MAX418 | 4 | 8 | 1 | 4.0 |
| MAX419 | 4 | 150 | 10 | 4.0 |

* With BW pin open or connected to V-

** With BW pin connected to V+

Ordering Information appears at end of data sheet.

Typical Operating Circuit

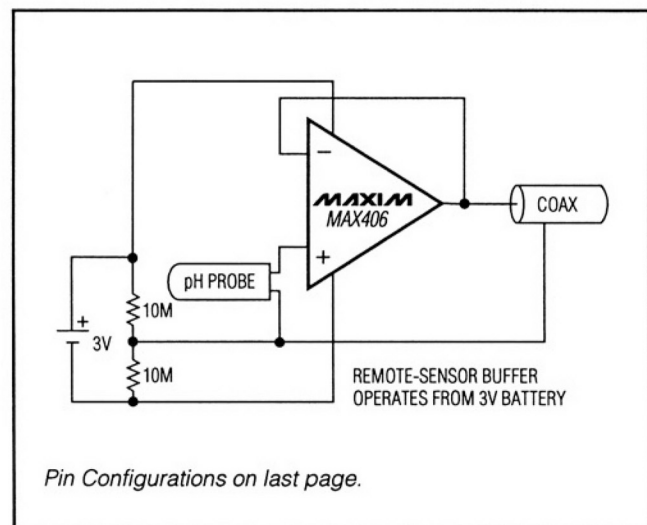
MAX406/MAX407/MAX409/MAX417-MAX419
MAXIM

Maxim Integrated Products 1

For pricing, delivery, and ordering information, please contact Maxim Direct at 1-888-629-4642, or visit Maxim's website at www.maxim-ic.com.

1.2μA Max, Single/Dual/Quad, Single-Supply Op Amps

ABSOLUTE MAXIMUM RATINGS

| | | | |
|---|----------------------------|--|-----------------|
| Total Supply Voltage (V+ to V-) | 12V | 14-Pin Plastic DIP (derate 10.00mW/°C above +70°C) | 800mW |
| Input Voltage (V+ to V-) | (V+ + 0.3V) to (V- - 0.3V) | 14-Pin SO (derate 8.33mW/°C above +70°C) | 667mW |
| Continuous Current | | 14-Pin CERDIP (derate 9.09mW/°C above +70°C) | 727mW |
| All Input Pins | 10mA | Operating Temperature Ranges: | |
| All Other Pins | 50mA | MAX4_ _C_ _ | 0°C to +70°C |
| Short-Circuit Duration | Continuous | MAX4_ _E_ _ | -40°C to +85°C |
| Continuous Power Dissipation (T _A = +70°C) | | MAX4_ _M_ _ | -55°C to +125°C |
| 8-Pin Plastic DIP (derate 9.09mW/°C above +70°C) | 727mW | Storage Temperature Range | -65°C to +160°C |
| 8-Pin SO (derate 5.88mW/°C above +70°C) | 471mW | Lead Temperature (soldering, 10sec) | +300°C |
| 8-Pin CERDIP (derate 8.00mW/°C above +70°C) | 640mW | | |

Note 1: Absolute Maximum Ratings do not apply to devices supplied in die or wafer form.

Stresses beyond those listed under "Absolute Maximum Ratings" may cause permanent damage to the device. These are stress ratings only, and functional operation of the device at these or any other conditions beyond those indicated in the operational sections of the specifications is not implied. Exposure to absolute maximum rating conditions for extended periods may affect device reliability.

ELECTRICAL CHARACTERISTICS

(V+ = 2.5V, V- = -2.5V, T_A = +25°C, unless otherwise noted.)

| PARAMETER | SYMBOL | CONDITIONS | | MIN | TYP | MAX | UNITS |
|------------------------------|------------------|---|--|-------|-------|---------|-------|
| Input Offset Voltage | V _{OS} | MAX406A, MAX409A | | | 0.25 | 0.5 | mV |
| | | MAX406B, MAX409B | | | 0.75 | 2.0 | |
| | | MAX407, MAX417 | | | 1.0 | 3.0 | |
| | | MAX418, MAX419 | | | 1.0 | 4.0 | |
| Input Bias Current | I _B | V _{CM} = 0V (Note 2) | | | <0.1 | 10.0 | pA |
| Large-Signal Voltage Gain | A _{VOL} | R _L = 1MΩ, V _{OUT} = ±2V | MAX406A, MAX409A | 200 | 1000 | | V/mV |
| | | | MAX406B, MAX407, MAX409B, MAX41_ | 100 | 1000 | | |
| | | R _L = 1MΩ, V _{OUT} = ±4V, V+ = 5V, V- = -5V | | 10 | 23 | | |
| Gain Bandwidth | GBW | MAX406A/B | Compensated mode | 4 | 8 | | kHz |
| | | | Decompensated mode (A _v = 2V/V) | 20 | 40 | | |
| | | MAX407, MAX418 | | | 4 | 8 | |
| | | MAX409A/B, MAX417, MAX419, A _{vCL} ≥ 10V/V | | 80 | 150 | | |
| Input Common-Mode Range | CMR | MAX406A/B, MAX409A/B | | V- | | V+ -1.1 | V |
| | | MAX407, MAX41_ | | V- | | V+ -1.2 | |
| Output Voltage Swing | V _O | R _L = 1MΩ | | ±2.47 | ±2.49 | | V |
| Common-Mode Rejection Ratio | CMRR | (Note 3) | MAX406A, MAX409A | 70 | 80 | | dB |
| | | | MAX406B, MAX407, MAX409B, MAX41_ | 60 | 80 | | |
| Power-Supply Rejection Ratio | PSRR | V _{IN} = 0V, V+ = 2.5V to 7.5V | MAX406A, MAX409A | | 50 | 100 | μV/V |
| | | | MAX406B, MAX409B | | 150 | 300 | |
| | | | MAX407, MAX41_ | | 200 | 600 | |

1.2μA Max, Single/Dual/Quad, Single-Supply Op Amps

ELECTRICAL CHARACTERISTICS (continued)

(V+ = 2.5V, V- = -2.5V, TA = +25°C, unless otherwise noted.)

| PARAMETER | SYMBOL | CONDITIONS | MIN | TYP | MAX | UNITS | |
|------------------------------|----------|---|--------------------------------|-----|------|--------|------|
| Slew Rate | SR | MAX406A/B | Compensated mode | | 3 | 5 | V/ms |
| | | | Decompensated mode (Av = 2V/V) | | 12 | 20 | |
| | | MAX407, MAX418 | | 3 | 5 | | |
| | | MAX409A/B, MAX417, MAX419 AvCL ≥ 10V/V | | 40 | 80 | | |
| Supply Current Per Amplifier | ISY | | | 1.0 | 1.2 | μA | |
| Output Sink Current | IOSINK | VOUT = 0V | 100 | 200 | | μA | |
| Output Source Current | IOSOURCE | VOUT = 0V | 300 | 600 | | μA | |
| Supply Voltage (V+ to V-) | VS | | 2.5 | | 10.0 | V | |
| Input Noise Voltage | en | f0 = 1kHz | | 150 | | nV/√Hz | |
| | | f0 = 0.1Hz to 10Hz | | 6 | | μVp-p | |

ELECTRICAL CHARACTERISTICS

(V+ = 2.5V, V- = -2.5V, TA = 0°C to +70°C, unless otherwise noted.)

| PARAMETER | SYMBOL | CONDITIONS | MIN | TYP | MAX | UNITS |
|------------------------------|--------|---|------------------------------------|-----|------|-------|
| Input Offset Voltage | VOS | MAX406A, MAX409A | | | 0.95 | mV |
| | | MAX406B, MAX409B | | | 3.00 | |
| | | MAX407 | | | 4.00 | |
| | | MAX41_ | | | 5.00 | |
| Offset-Voltage Tempco | TCVOS | MAX406A, MAX409A, 100% drift tested | | 2 | 10 | μV/°C |
| Input Bias Current | IB | VCM = 0V | | | 20 | pA |
| Large-Signal Voltage Gain | AVOL | RL = 1MΩ, VOUT = ±2V | MAX406A, MAX409A | | 100 | V/mV |
| | | | MAX406B | | 50 | |
| | | RL = 1MΩ, (VOUT = ±4V, V+ = 5V, V- = -5V) | | | 10 | |
| Output Voltage Swing | VO | RL = 1MΩ | ±2.45 | | | V |
| Common-Mode Rejection Ratio | CMRR | (Note 3) | MAX406A, MAX409A | | 66 | dB |
| | | | MAX406B, MAX407 MAX409B, MAX41_ | | 60 | |
| Power-Supply Rejection Ratio | PSRR | VIN = 0V, V+ = 2.5V to 7.5V | MAX406A, MAX409A | | 150 | μV/V |
| | | | MAX406B, MAX409B | | 450 | |
| | | | MAX407, MAX41_ | | 800 | |

MAX406/MAX407/MAX409/MAX417-MAX419

1.2μA Max, Single/Dual/Quad, Single-Supply Op Amps

ELECTRICAL CHARACTERISTICS (continued)

(V+ = 2.5V, V- = -2.5V, TA = 0°C to +70°C, unless otherwise noted.)

| PARAMETER | SYMBOL | CONDITIONS | MIN | TYP | MAX | UNITS |
|------------------------------|----------|------------|-----|-----|-----|-------|
| Supply Current Per Amplifier | ISY | | | | 1.6 | μA |
| Output Sink Current | IOSINK | VOUT = 0V | 50 | | | μA |
| Output Source Current | IOSOURCE | VOUT = 0V | 250 | | | μA |

ELECTRICAL CHARACTERISTICS

(V+ = 2.5V, V- = -2.5V, TA = -40°C to +85°C, unless otherwise noted.)

| PARAMETER | SYMBOL | CONDITIONS | MIN | TYP | MAX | UNITS |
|------------------------------|----------|---|----------------------------------|------------------|------|-------|
| Input Offset Voltage | VOS | MAX406A, MAX409A | | | 1.10 | mV |
| | | MAX406B, MAX409B | | | 3.00 | |
| | | MAX407, MAX417 | | | 4.00 | |
| | | MAX418, MAX419 | | | 5.00 | |
| Offset-Voltage Tempco | TCVOS | MAX406A, MAX409A, 100% drift tested | | | 10 | μV/°C |
| Input Bias Current | IB | VCM = 0V | | | 50 | pA |
| Large-Signal Voltage Gain | AVOL | RL = 1MΩ, VOUT = ±2V | | | | V/mV |
| | | | MAX406A, MAX409A | 50 | | |
| | | | MAX406B, MAX407, MAX409B, MAX41_ | 25 | | |
| | | RL = 1MΩ, VOUT = ±4V, V+ = 5V, V- = -5V | 10 | | | |
| Output Voltage Swing | VO | RL = 1MΩ | ±2.45 | | | V |
| Common-Mode Rejection Ratio | CMRR | (Note 3) | | | | dB |
| | | | | MAX406A, MAX409A | 66 | |
| | | | | | 60 | |
| Power-Supply Rejection Ratio | PSRR | VIN = 0V, V+ = 2.5V to 7.5V | | | | μV/V |
| | | | | MAX406A, MAX409A | 150 | |
| | | | | MAX406B, MAX409B | 450 | |
| | | | | | 800 | |
| Supply Current Per Amplifier | ISY | | | | 1.7 | μA |
| Output Sink Current | IOSINK | VOUT = 0V | 40 | | | μA |
| Output Source Current | IOSOURCE | VOUT = 0V | 250 | | | μA |

1.2μA Max, Single/Dual/Quad, Single-Supply Op Amps

ELECTRICAL CHARACTERISTICS

(V+ = 2.5V, V- = -2.5V, TA = -55°C to +125°C, unless otherwise noted.)

| PARAMETER | SYMBOL | CONDITIONS | | MIN | TYP | MAX | UNITS |
|------------------------------|----------------------|---|-------------------------------------|-------|-----|-----|-------|
| Input Offset Voltage | V _{OS} | MAX406A, MAX409A | | | | 1.5 | mV |
| | | MAX406B, MAX409B | | | | 4.0 | |
| | | MAX407, MAX417 | | | | 5.0 | |
| | | MAX418, MAX419 | | | | 6.0 | |
| Offset-Voltage Tempco | TC _{VOS} | MAX406A, MAX409A, 100% drift tested | | | | 10 | μV/°C |
| Input Bias Current | I _B | V _{CM} = 0V | | | | 1.0 | nA |
| Large-Signal Voltage Gain | A _{VOL} | R _L = 1MΩ, V _{OUT} = ±2V | MAX406A, MAX409A | 10 | | | V/mV |
| | | | MAX406B, MAX407, MAX409B, MAX41_ | 5 | | | |
| | | R _L = 1MΩ, V _{OUT} = ±4V, V+ = 5V, V- = -5V | | 10 | | | |
| Output Voltage Swing | V _O | R _L = 1MΩ | | ±2.45 | | | V |
| Common-Mode Rejection Ratio | CMRR | (Note 3) | MAX406A, MAX409A | 66 | | | dB |
| | | | MAX406B, MAX407, MAX409B, MAX41_ | 60 | | | |
| Power-Supply Rejection Ratio | PSRR | V _{IN} = 0V, V+ = 2.5V to 7.5V | MAX406A, MAX409A | | | 150 | μV/V |
| | | | MAX406B, MAX409B | | | 450 | |
| | | | MAX407, MAX41_ | | | 800 | |
| Supply Current Per Amplifier | I _{SY} | | | | | 2.0 | μA |
| Output Sink Current | I _{OSINK} | V _{OUT} = 0V | | 20 | | | μA |
| Output Source Current | I _{OSOURCE} | V _{OUT} = 0V | | 200 | | | μA |

Note 2: Production-automated test equipment cannot resolve input bias currents below 1pA. Lab equipment has shown the MAX40_, MAX41_ typical input bias currents below 0.1pA.

Note 3: MAX406A/MAX409A: V_{CM} = V- to (V+ - 1.1V). MAX407, MAX41_ V_{CM} = V- to (V+ - 1.2V).

MAX406/MAX407/MAX409/MAX417-MAX419

1.2μA Max, Single/Dual/Quad, Single-Supply Op Amps

Typical Operating Characteristics

(V+ 2.5V, V- = -2.5V, T_A = +25°C, unless otherwise noted.)

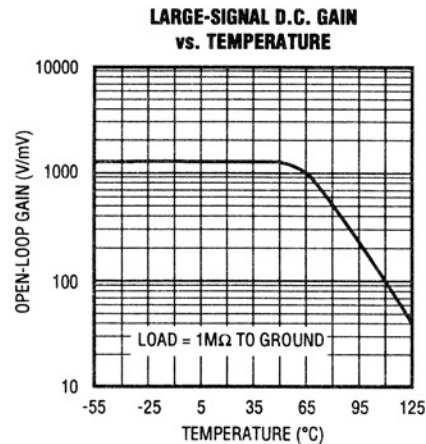
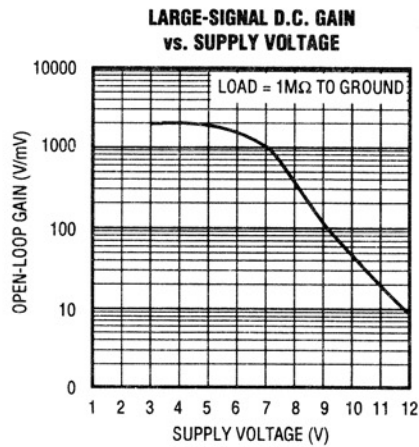
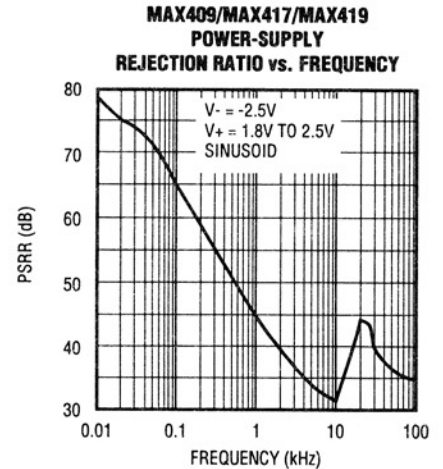
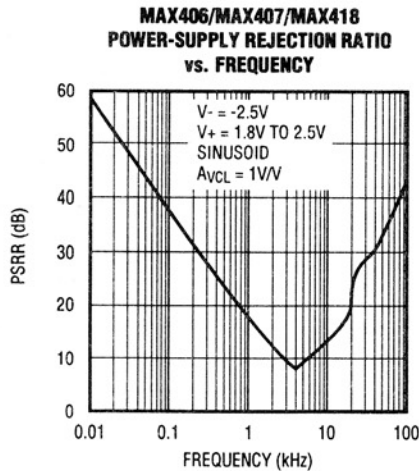
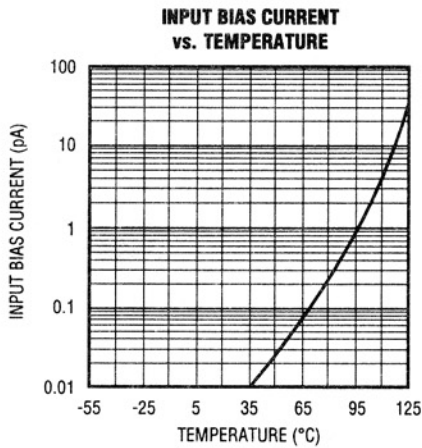
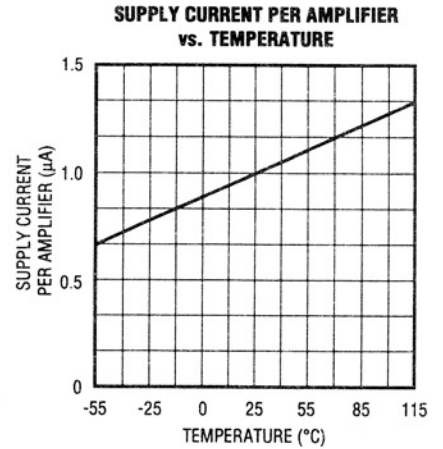
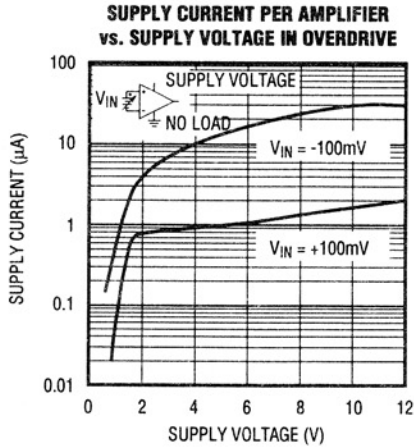
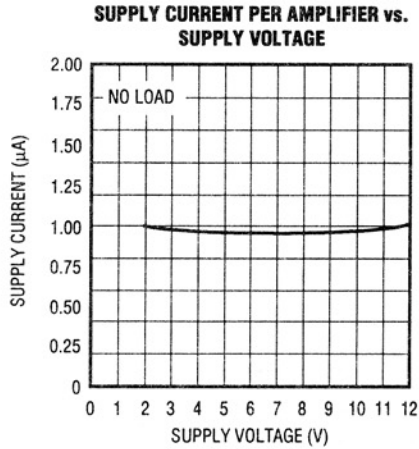

1.2μA Max, Single/Dual/Quad, Single-Supply Op Amps

Typical Operating Characteristics (continued)

(V+ = 2.5V, V- = -2.5V, TA = +25°C, unless otherwise noted).

MAX406/MAX407/MAX409/MAX417-MAX419

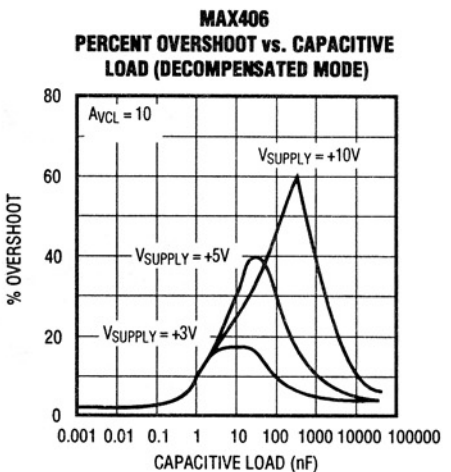
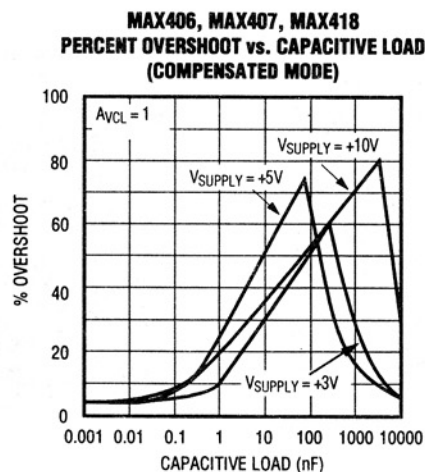
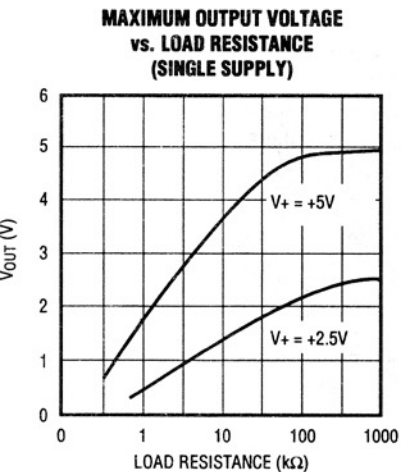
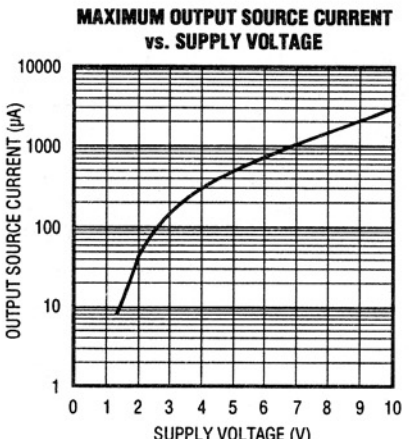
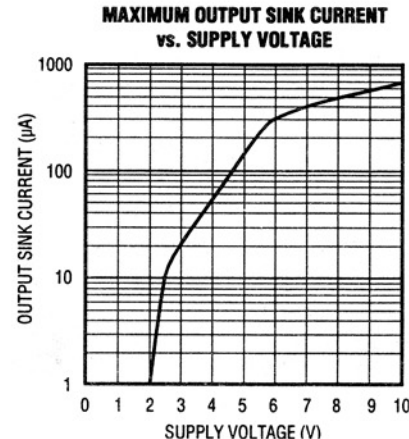
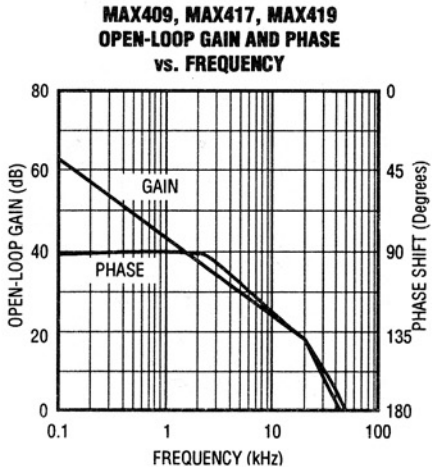
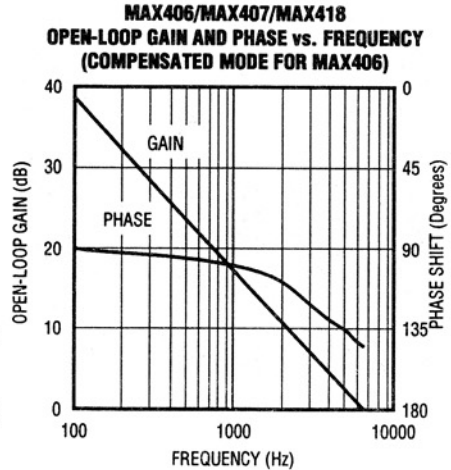
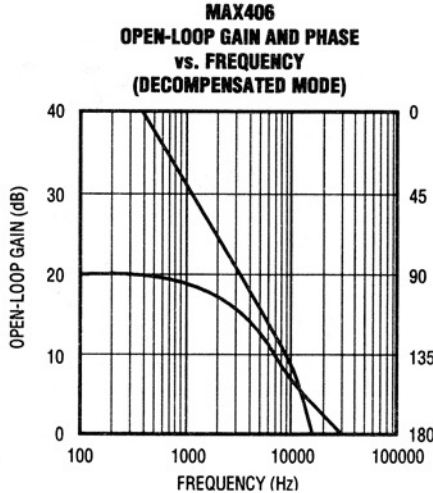
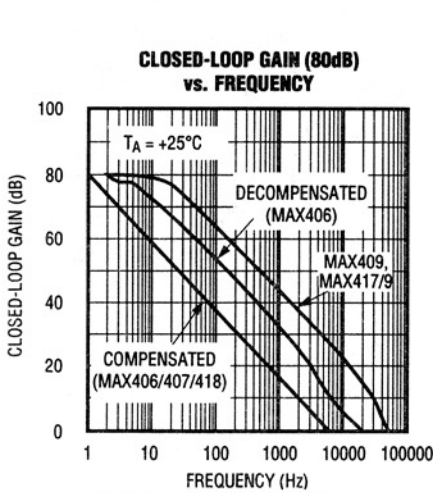

1.2 μ A Max, Single/Dual/Quad, Single-Supply Op Amps

Typical Operating Characteristics

($T_A = +25^\circ\text{C}$, unless otherwise noted).

**MAX406/MAX407/MAX418
LARGE-SIGNAL TRANSIENT RESPONSE**

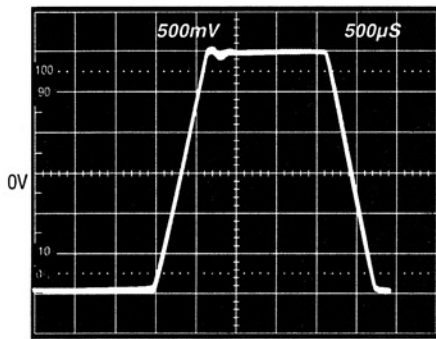

NONINVERTING, $A_{VCL} = 1V/V$,
 $V_{SUPPLY} = \pm 2.5V$, $LOAD = 1M\Omega \parallel 250pF$

**MAX406/MAX407/MAX418
LARGE-SIGNAL TRANSIENT RESPONSE**

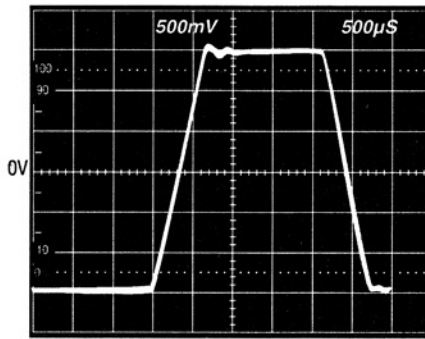

NONINVERTING, $A_{VCL} = 1V/V$,
 $V_{SUPPLY} = \pm 2.5V$, $LOAD = 1M\Omega \parallel 1000pF$

**MAX406 (DECOMPENSATED MODE)
LARGE-SIGNAL TRANSIENT RESPONSE**

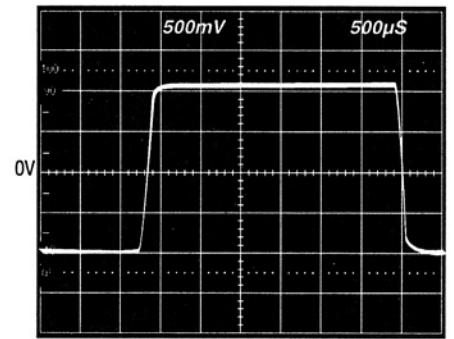

$V_{SUPPLY} = \pm 2.5V$, $A_{VCL} = 2V/V$,
 $LOAD = 1M\Omega \parallel 15pF$

**MAX406/MAX407/MAX418
SMALL-SIGNAL TRANSIENT RESPONSE**

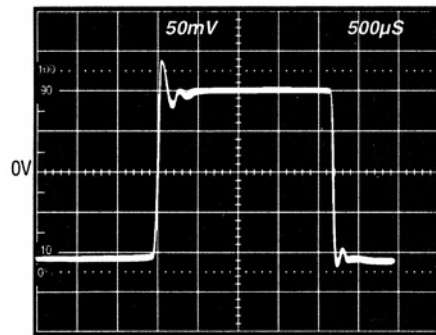

NONINVERTING, $A_{VCL} = 1V/V$,
 $V_{SUPPLY} = \pm 2.5V$, $LOAD = 1M\Omega \parallel 250pF$

**MAX406/MAX407/MAX418
SMALL-SIGNAL TRANSIENT RESPONSE**

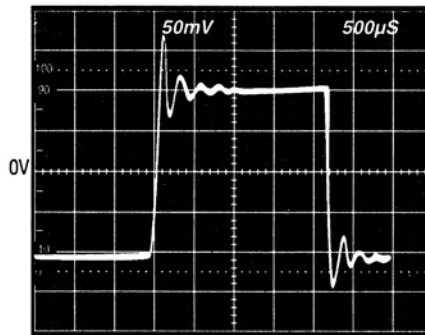

NONINVERTING, $A_{VCL} = 1V/V$,
 $V_{SUPPLY} = \pm 2.5V$, $LOAD = 1M\Omega \parallel 1000pF$

**MAX406 (DECOMPENSATED MODE)
SMALL-SIGNAL TRANSIENT RESPONSE**

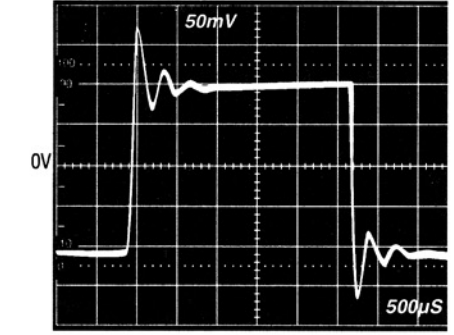

$A_{VCL} = 10V/V$,
 $V_{SUPPLY} = \pm 2.5V$, $LOAD = 1M\Omega \parallel 1000pF$

**MAX409/MAX417/MAX419
LARGE-SIGNAL TRANSIENT RESPONSE**

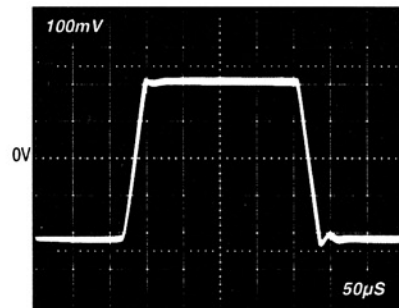

$A_V = 10V/V$, $V_{SUPPLY} = \pm 2.5V$, $LOAD = 1M\Omega \parallel 10pF$

**MAX409/MAX417/MAX419
SMALL-SIGNAL TRANSIENT RESPONSE**

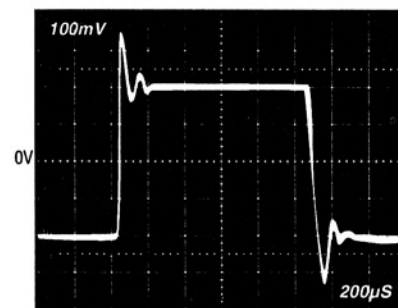

$A_V = 10V/V$, $V_{SUPPLY} = \pm 2.5V$, $LOAD = 1M\Omega \parallel 110pF$

MAX406/MAX407/MAX409/MAX417-MAX419

1.2 μ A Max, Single/Dual/Quad, Single-Supply Op Amps

Typical Operating Characteristics (continued)

MAX409/MAX417/MAX419
LARGE-SIGNAL TRANSIENT RESPONSE

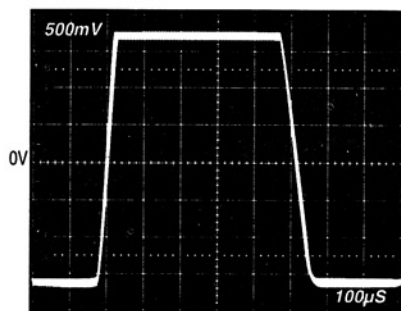

$A_V = 10V/V$, $V_{SUPPLY} = \pm 2.5V$, $LOAD = 1M\Omega \parallel 10pF$

MAX409/MAX417/MAX419
LARGE-SIGNAL TRANSIENT RESPONSE

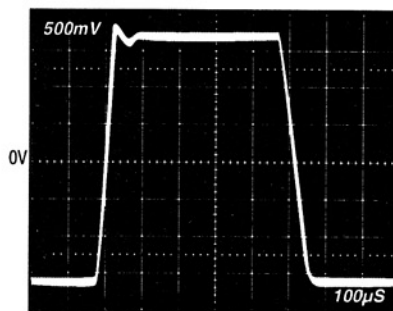

$A_V = 10V/V$, $V_{SUPPLY} = \pm 2.5V$, $LOAD = 1M\Omega \parallel 110pF$

Pin Description

| MAX406 PIN | MAX407 MAX417 PIN | MAX409 PIN | MAX418 MAX419 PIN | NAME | FUNCTION |
|------------|-------------------|------------|-------------------|------|---|
| 1 | | 1 | | NULL | Nulling. Connect to one end of 100k potentiometer for offset voltage trimming. See Figure 1. |
| | 1 | | 1 | OUTA | Amplifier Output A |
| 2 | | 2 | | IN- | Inverting Input |
| | 2 | | 2 | INA- | Inverting Input A |
| 3 | | 3 | | IN+ | Noninverting Input |
| | 3 | | 3 | INA+ | Noninverting Input A |
| 4 | 4 | 4 | 11 | V- | Negative Power-Supply Pin. Connect to (-) terminal of power supply or ground. |
| 5 | | 5 | | NULL | Nulling. Connect to one end of 100k potentiometer for offset voltage trimming. Connect wiper to V+. See Figure 1. |
| | 5 | | 5 | INB+ | Noninverting Input B |
| 6 | | 6 | | OUT | Amplifier Output |
| | 6 | | 6 | INB- | Inverting Input B |
| 7 | 8 | 7 | 4 | V+ | Positive Supply Pin. Connect to (+) terminal of power supply. |
| | 7 | | 7 | OUTB | Amplifier Output B |
| 8 | | | | BW | Bandwidth Selection Pin. Leave floating or connect to V- for unity-gain stability (compensated mode) or connect to V+ (decompensated mode). |
| | | 8 | | I.C. | Internal Connection. Make no connection to this pin. |
| | | | 8 | OUTC | Amplifier Output C |
| | | | 9 | INC- | Inverting Input C |
| | | | 10 | INC+ | Noninverting Input C |
| | | | 12 | IND+ | Noninverting Input D |
| | | | 13 | IND- | Inverting Input D |
| | | | 14 | OUTD | Amplifier Output D |

1.2μA Max, Single/Dual/Quad, Single-Supply Op Amps

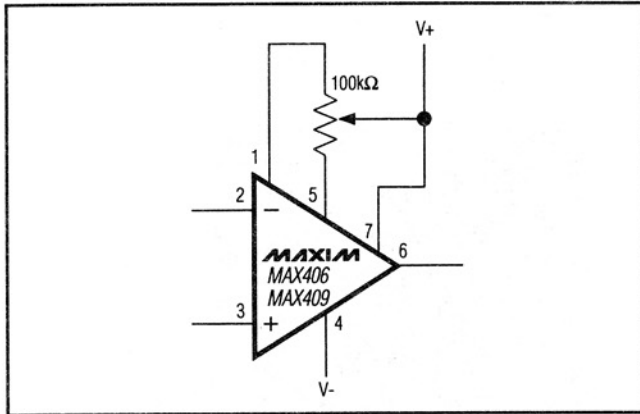

Figure 1. Offset-Voltage Adjustment

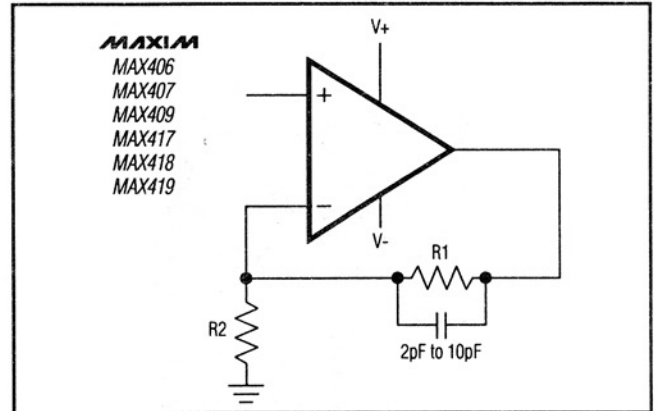

Figure 2. Compensation for Feedback Node Capacitance

Applications Information

Trimming Voltage Offset

The MAX406/MAX409's typical input offset voltage is between 0.25mV and 0.75mV, depending on the grade. If the application requires additional offset adjustment, connect a 100kΩ trim pot between pins 1, 5, and 7 for the MAX406/MAX409 (Figure 1). The dual and quad amplifiers' offset voltages are not adjustable.

Input Overdrive vs. Supply Current

The supply current of the MAX406/MAX407/MAX409/MAX417-MAX419 remains relatively constant over the supply range if the amplifier output is not overdriven to the negative supply rail. For example, when connecting the amplifier as a comparator and applying a -100mV input overdrive, supply current rises above the 1μA per amplifier typical value and varies with supply voltage. (see Supply Current vs. Supply Voltage in Overdrive, *Typical Operating Characteristics*).

Total Supply-Voltage Considerations

Although the MAX406/MAX407/MAX409/MAX417-MAX419 can operate with supply voltages between 2.5V and 10V, best performance is achieved with supply voltages below 7V. The Open-Loop Gain vs. Supply Voltage graph in the *Typical Operating Characteristics* shows how open-loop gain is reduced at voltages that exceed 7V.

Bandwidth

The MAX407/MAX418 are internally compensated for stable unity-gain operation, with an 8kHz typical gain bandwidth. The MAX409/MAX417/MAX419 have a 150kHz typical gain-bandwidth product and are stable with a gain of 10V/V or greater.

The MAX406 operates in one of two modes. Floating BW or connecting BW to V- internally compensates the amplifier for stable unity-gain operation. Connecting BW to V+ reduces the compensation and allows the amplifier to be used at higher speeds. When operating in decompensated mode, the MAX406 is stable for closed loop gains $\geq 2V/V$, with a 40kHz typical gain bandwidth and a 20V/ms typical slew rate.

Stability

Unlike other industry-standard micropower CMOS op amps, the MAX406/MAX407/MAX409/MAX417-MAX419 maintain stability in their minimum gain configuration while driving heavy capacitive loads, as demonstrated in the Percent Overshoot vs. Capacitive Load graph in the *Typical Operating Characteristics*.

Although this product family is primarily designed for low-frequency applications, good layout is extremely important. This is because low power requirements demand high-impedance circuits. A 10MΩ impedance and a 1pF capacitance will provide a breakpoint at approximately 16kHz, which is near the amplifier's bandwidth. The layout should minimize stray capacitance at the amplifier's inputs. However, some stray capacitance may be unavoidable, and it may be necessary to add a 2pF to 10pF capacitor across the feedback resistor as shown in Figure 2. Select the smallest capacitor value that insures stability.

Typical Application Circuits

Buffered pH Probe Allows Low-Cost Cable

The MAX406 has less than 20pA input leakage current over the commercial temperature range, and is typically less than 100fA at +25°C. These characteristics are ideal for buffering pH probes and a variety of other high output impedance chemical sensors. The circuit in

1.2 μ A Max, Single/Dual/Quad, Single-Supply Op Amps

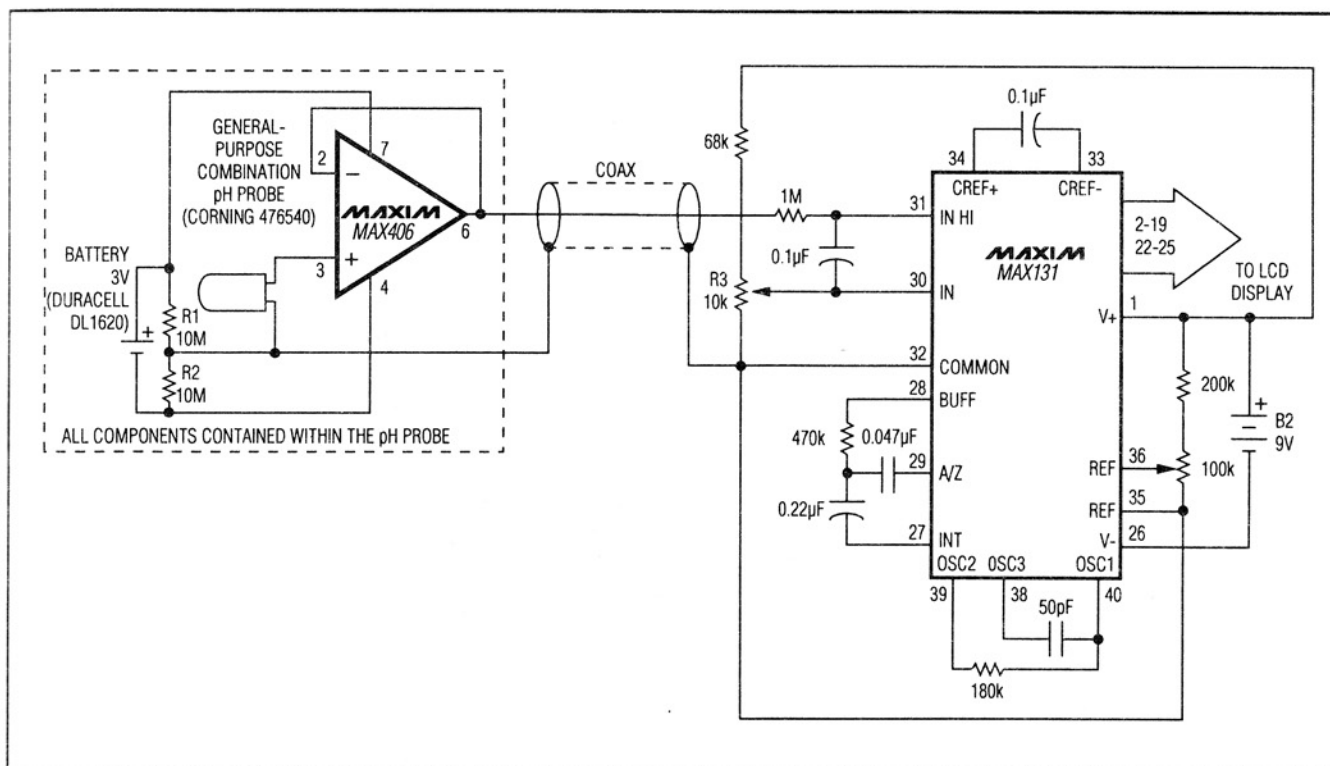

Figure 3. Buffered pH Probe Allows Low-Cost Cable

Figure 3 eliminates expensive low-leakage cables that often connect pH probes to meters. A MAX406 and a lithium battery are included in the probe housing. A conventional low-cost coaxial cable carries the buffered pH signal to the MAX131 A/D converter. In most cases, the probe assembly's battery life exceeds the functional life of the probe itself.

Micropower, 4-Channel Simultaneous Sample-and-Hold

Switch leakage and buffer input bias current in sample and hold circuits limit performance by discharging the signal voltage on the hold capacitor (an effect called "droop"). The 2pA typical room temperature leakage current for the MAX327 and 100fA typical input bias current for the MAX407 translates to a typical droop rate of 200 μ V/sec for Figure 4's circuit. Another advantage is low power consumption. The MAX327 guarantees no more than 250 μ A supply current with \pm 15V supplies, but most of this is drawn by internal logic-level translators. By using rail-to-rail logic (CD4000, 74C00, or 74HC00 families) to drive IN1-IN3, the level

translators are turned off and the supply current falls well below 1 μ A when the switches are off. This technique turns any Maxim switch or multiplexer into an ultra low-power device. Figure 4's circuit typically draws 6 μ A with 0V to 9V logic input levels.

Remotely Powered Sensor Amp

Figure 5 shows a simple 2-wire current transmitter that uses no power at the transmitting end except from the transmitted signal itself. At the transmitter, a 0V to 1V input drives both a MAX406 and an NPN transistor connected as a voltage-controlled current sink. The 0mA to 2mA output is sent through a twisted pair to the receiver and develops a voltage across the receiver sense resistor R2. The resulting sense voltage is buffered by another MAX406, producing a 0V to 1V ground-referenced output signal. R1 and R2 should be well matched. The MAX406's supply current is added to the 0mA to 2mA signal, resulting in a 500 μ V offset at the output. This offset, in addition to the MAX406's input offset, varies with temperature.

MAX406/MAX407/MAX409/MAX417-MAX419

1.2μA Max, Single/Dual/Quad, Single-Supply Op Amps

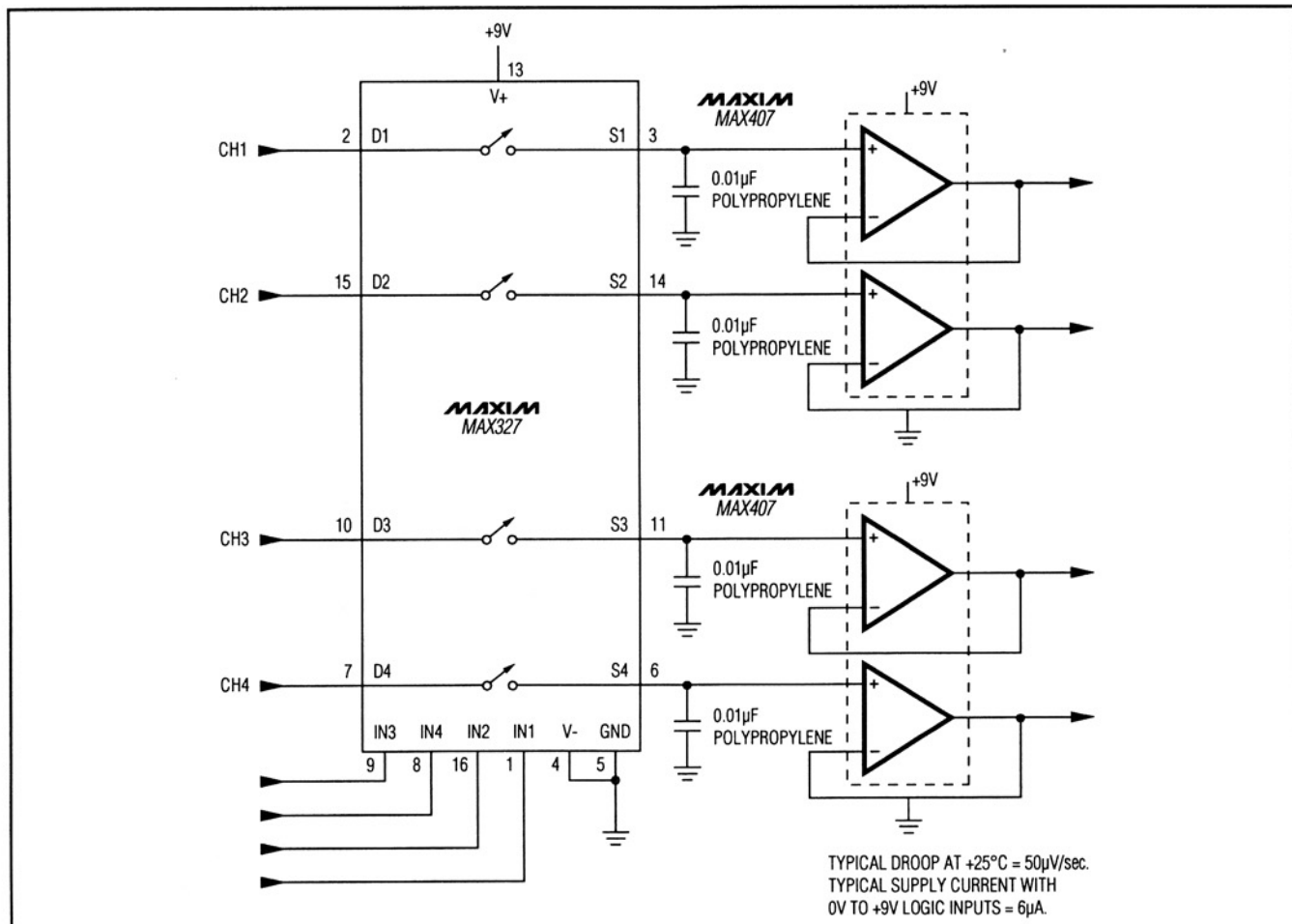

Figure 4. Micropower, 4-Channel, Simultaneous Sample-and-Hold

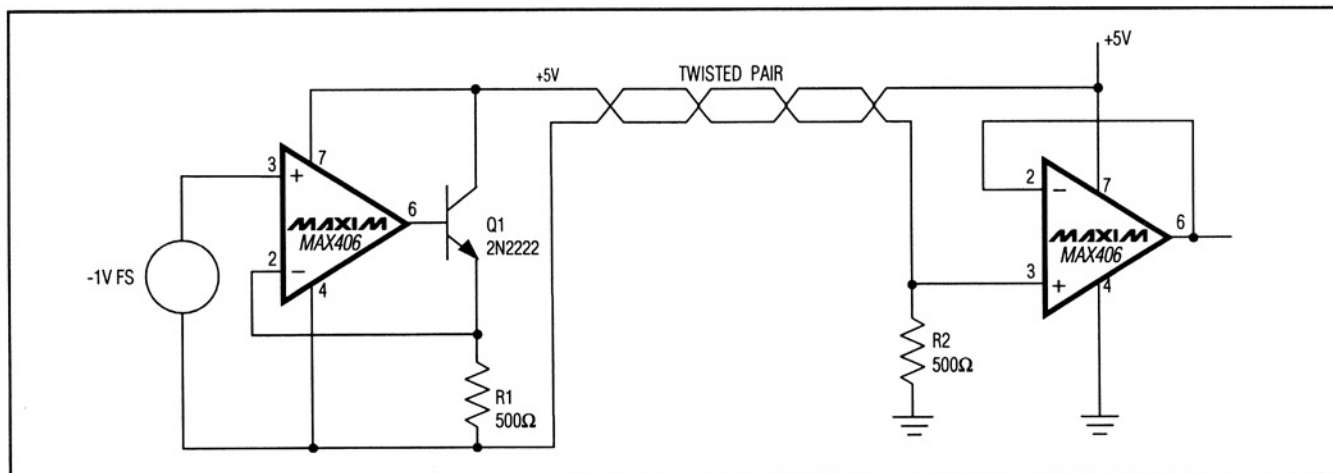

Figure 5. Remotely Powered Sensor Amp

1.2 μ A Max, Single/Dual/Quad, Single-Supply Op Amps

Negative Reference Circuit Draws Less Than 11 μ A

By biasing a low-power, low-dropout reference (MAX872) so it sits in the feedback path of a MAX406, a precise -2.50V reference is produced that requires no external components, as shown in Figure 6. This is superior to a standard inverting configuration, which requires two resistors that can add errors.

Other advantages of this circuit are:

1. Maximum current drain is 11 μ A.
2. The output load is driven by the op amp so there is no degradation of voltage due to load regulation.
3. No compensation is needed for load capacitance.

The supplies do not have to be carefully regulated. The positive supply can be as low as 1.1V and the negative supply can be as little as 2.7V.

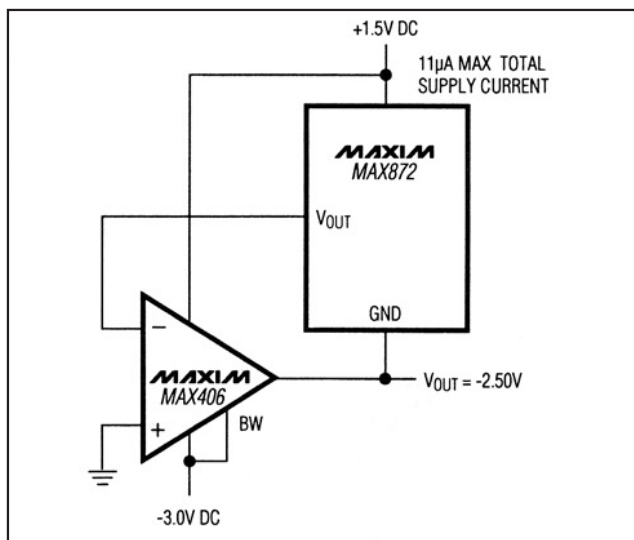

Figure 6. Micropower, Low-Dropout Negative Reference

Ordering Information

| PART | TEMP RANGE | PIN-PACKAGE |
|------------|-----------------|---------------|
| MAX406ACPA | 0°C to +70°C | 8 Plastic DIP |
| MAX406BCPA | 0°C to +70°C | 8 Plastic DIP |
| MAX406ACSA | 0°C to +70°C | 8 SO |
| MAX406BCSA | 0°C to +70°C | 8 SO |
| MAX406C/D | 0°C to +70°C | Dice* |
| MAX406AEPA | -40°C to +85°C | 8 Plastic DIP |
| MAX406BEPA | -40°C to +85°C | 8 Plastic DIP |
| MAX406AESA | -40°C to +85°C | 8 SO |
| MAX406BESA | -40°C to +85°C | 8 SO |
| MAX406AMJA | -55°C to +125°C | 8 CERDIP |
| MAX406BMJA | -55°C to +125°C | 8 CERDIP |
| MAX407CPA | 0°C to +70°C | 8 Plastic DIP |
| MAX407CSA | 0°C to +70°C | 8 SO |
| MAX407C/D | 0°C to +70°C | Dice* |
| MAX407EPA | -40°C to +85°C | 8 Plastic DIP |
| MAX407ESA | -40°C to +85°C | 8 SO |
| MAX407MJA | -55°C to +125°C | 8 CERDIP |
| MAX409ACPA | 0°C to +70°C | 8 Plastic DIP |
| MAX409BCPA | 0°C to +70°C | 8 Plastic DIP |
| MAX409ACSA | 0°C to +70°C | 8 SO |
| MAX409BCSA | 0°C to +70°C | 8 SO |
| MAX409BC/D | 0°C to +70°C | Dice* |
| MAX409AEPA | -40°C to +85°C | 8 Plastic DIP |
| MAX409BEPA | -40°C to +85°C | 8 Plastic DIP |

| PART | TEMP RANGE | PIN-PACKAGE |
|----------------|-----------------|----------------|
| MAX409AESA | -40°C to +85°C | 8 SO |
| MAX409BESA | -40°C to +85°C | 8 SO |
| MAX409AMJA | -55°C to +125°C | 8 CERDIP |
| MAX409BMJA | -55°C to +125°C | 8 CERDIP |
| MAX417CPA | 0°C to +70°C | 8 Plastic DIP |
| MAX417CSA | 0°C to +70°C | 8 SO |
| MAX417C/D | 0°C to +70°C | Dice* |
| MAX417EPA | -40°C to +85°C | 8 Plastic DIP |
| MAX417ESA | -40°C to +85°C | 8 SO |
| MAX417MJA | -55°C to +125°C | 8 CERDIP |
| MAX418CPD | 0°C to +70°C | 14 Plastic DIP |
| MAX418CSD | 0°C to +70°C | 14 SO |
| MAX418EPD | 0°C to +70°C | 14 Plastic DIP |
| MAX418ESD | 0°C to +70°C | 14 SO |
| MAX418MJD | -55°C to +125°C | 14 CERDIP |
| MAX418MSD/PR | -55°C to +125°C | 14 SO |
| MAX418MSD/PR-T | -55°C to +125°C | 14 SO |
| MAX419CPD | 0°C to +70°C | 14 Plastic DIP |
| MAX419CSD | 0°C to +70°C | 14 SO |
| MAX419EPD | -40°C to +85°C | 14 Plastic DIP |
| MAX419ESD | -40°C to +85°C | 14 SO |
| MAX419MJD | -55°C to +125°C | 14 CERDIP |

*Dice are specified at +25°C, DC parameters only.

**Contact factory for availability.

MAX406/MAX407/MAX409/MAX417-MAX419

1.2μA Max, Single/Dual/Quad, Single-Supply Op Amps

Pin Configurations

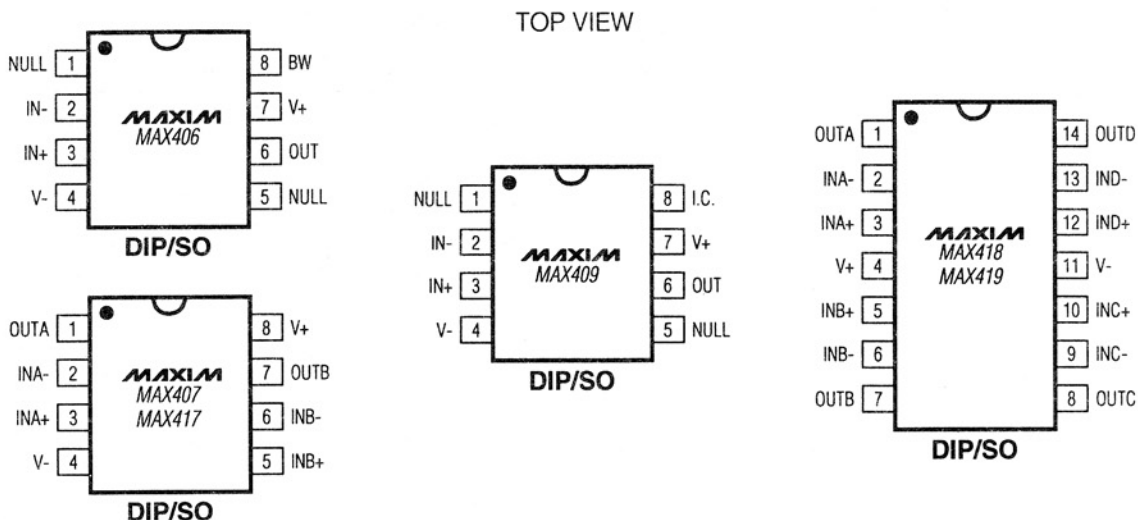

Chip Topographies

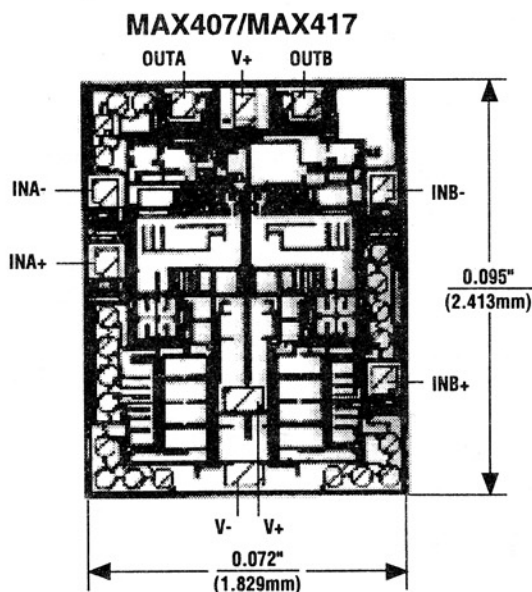

TRANSISTOR COUNT: 98;
SUBSTRATE CONNECTED TO V+.

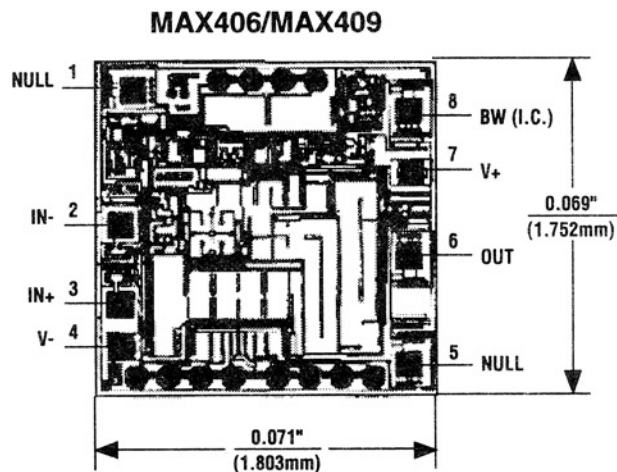

TRANSISTOR COUNT: 148;
SUBSTRATE CONNECTED TO V+.

1.2 μ A Max, Single/Dual/Quad, Single-Supply Op Amps

Package Information

For the latest package outline information and land patterns, go to www.maxim-ic.com/packages.

| PACKAGE TYPE | PACKAGE CODE | DOCUMENT NO. |
|----------------|--------------|-------------------------|
| 8 Plastic DIP | P8-1 | 21-0043 |
| 8 SO | S8-2 | 21-0041 |
| 8 CERDIP | J8-2 | 21-0045 |
| 14 Plastic DIP | P14-3 | 21-0043 |
| 14 SO | S14-1 | 21-0041 |
| 14 CERDIP | J14-3 | 21-0045 |

MAX406/MAX407/MAX409/MAX417-MAX419

1.2µA Max, Single/Dual/Quad, Single-Supply Op Amps

Revision History

| REVISION NUMBER | REVISION DATE | DESCRIPTION | PAGES CHANGED |
|-----------------|---------------|---|---------------|
| 3 | 10/08 | Added information for rugged plastic part | 13 |
| 4 | 4/09 | Updated <i>Ordering Information</i> | 1, 13, 15 |

Maxim cannot assume responsibility for use of any circuitry other than circuitry entirely embodied in a Maxim product. No circuit patent licenses are implied. Maxim reserves the right to change the circuitry and specifications without notice at any time.

16 **Maxim Integrated Products, 120 San Gabriel Drive, Sunnyvale, CA 94086 408-737-7600**