

FEATURES**Low Cost****Low V_{OS} : 25 μ V max (AD510L), 100 μ V max (AD510J)****Low V_{OS} Drift: 0.5 μ V/ $^{\circ}$ C max (AD510L)****Internally Compensated****High Open Loop Gain: 10 6 min****Low Noise: 1 μ V p-p 0.01 to 10Hz****PRODUCT DESCRIPTION**

The AD510 is the first low cost high accuracy IC op amp available. Analog Devices' precise thermally-balanced layout combined with high-yield IC processing provides truly superlative op amp performance at the lowest possible cost. The device is internally compensated, thus eliminating the need for an additional external capacitor.

A truly precision device, the AD510 achieves laser trimmed offset voltages less than 25 μ V max and offset voltage drifts of 0.5 μ V/ $^{\circ}$ C max (nulled). Bias currents and offset currents are available at less than 10nA and 2.5nA respectively, while open loop gain is maintained at over 1,000,000, even under loaded conditions. Designed along a thermal axis, the AD510 is unaffected by thermal gradients across the monolithic chip caused by current loading.

The AD510 has fully protected inputs, permitting differential input voltages of up to $\pm V_S$ without voltage gain or bias current degradation due to reverse breakdown. The output is also protected from short circuits and drives 1000pF of load capacitance without oscillation.

The AD510 is specifically designed for applications requiring high precision at the lowest possible cost, such as bridge instruments, stable references, followers and analog computation. Packaged in a hermetically-sealed TO-99 metal can, the AD510 is available in three versions of performance (J, K and L) over the commercial temperature range, 0 to +70 $^{\circ}$ C and one version (S) over the extended temperature range, -55 $^{\circ}$ C to +125 $^{\circ}$ C.

PRODUCT HIGHLIGHTS

1. Offset voltage drift is guaranteed and 100% tested on all models with a controlled temperature drift bath with the offset voltage nulled. Offset voltage on the AD510L is tested following a 3 minute warm-up.
2. The AD510 offers fully protected input (to $\pm V_S$) and output circuitry. The input protection circuit prevents offset voltage and bias current degradation due to reverse breakdown, a critical factor in high accuracy op amps where overall performance is strongly dependent on front-end stability.
3. Internal compensation eliminates the need for elaborate and costly stabilizing networks, often required by many high accuracy IC op amps.
4. A thermally balanced layout maintains high gain (1,000,000 min, K, L and S) independent of offset nulling, power supply voltage and output loading.
5. Bootstrapping of critical input transistors produces CMRR and PSRR of 110dB min and 100dB min, respectively.
6. Every AD510 receives a 24 hour stabilization bake at 150 $^{\circ}$ C and a 48 hour burn-in at 125 $^{\circ}$ C to ensure reliability and long term stability.

Information furnished by Analog Devices is believed to be accurate and reliable. However, no responsibility is assumed by Analog Devices for its use; nor for any infringements of patents or other rights of third parties which may result from its use. No license is granted by implication or otherwise under any patent or patent rights of Analog Devices.

One Technology Way; P. O. Box 9106; Norwood, MA 02062-9106 U.S.A.
Tel: 617/329-4700
Telex: 174059
Twx: 710/394-6577
Cables: ANALOG NORWOODMASS

SPECIFICATIONS (typical @ +25°C and ±15V dc unless otherwise noted)

MODEL	AD510JH	AD510KH	AD510LH	AD510SH (AD510SH/883B)
OPEN LOOP GAIN				
$V_{OS} = \pm 10V, R_L > 2k\Omega$	250,000 min	10^6 min	**	**
T_{min} to T_{max}	125,000 min	500,000 min	**	250,000
OUTPUT CHARACTERISTICS				
Voltage @ $R_L \geq 2k\Omega, T_{min}$ to T_{max}	±10V min	*	*	*
Load Capacitance	1000pF	*	*	*
Output Current	10mA min	*	*	*
Short Circuit Current	25mA	*	*	*
FREQUENCY RESPONSE				
Unity Gain, Small Signal	300kHz	*	*	*
Full Power Response	1.5kHz	*	*	*
Slew Rate, Unity Gain	0.10V/μs	*	*	*
INPUT OFFSET VOLTAGE				
Initial Offset, $R_S \leq 10k\Omega$	100μV max	50μV max	25μV max	**
vs. Temp., T_{min} to T_{max}	3.0μV/°C max	1.0μV/°C max	0.5μV/°C max	**
vs. Supply	25μV/V max	10μV/V max	**	**
T_{min} to T_{max}	40μV/V max	15μV/V max	**	20μV/V max
INPUT OFFSET CURRENT				
Initial	5nA max	4nA max	2.5nA max	**
T_{min} to T_{max}	8nA max	6nA max	4nA max	10nA max
INPUT BIAS CURRENT				
Initial	25nA max	13nA max	10nA max	**
T_{min} to T_{max}	40nA max	20nA max	15nA max	30nA max
vs. Temp, T_{min} to T_{max}	±100pA/°C	±50pA/°C	±40pA/°C	**
INPUT IMPEDANCE				
Differential	4MΩ	6MΩ	**	**
Common Mode	100MΩ 4pF	*	*	*
INPUT NOISE				
Voltage, 0.1Hz to 10Hz	1μV p-p	*	*	*
f = 10Hz	18nV/√Hz	*	*	*
f = 100Hz	13nV/√Hz	*	*	*
f = 1kHz	10nV/√Hz	*	*	*
Current, f = 10Hz	0.5pA/√Hz	*	*	*
f = 100Hz	0.3pA/√Hz	*	*	*
f = 1kHz	0.3pA/√Hz	*	*	*
INPUT VOLTAGE RANGE				
Differential or Common Mode max safe	±V _S	*	*	*
Common Mode Rejection, $V_{in} = \pm 10V$	94dB min	110dB min	**	**
Common Mode Rejection, T_{min} to T_{max}	94dB	100dB min	**	**
POWER SUPPLY				
Rated Performance	±15V	*	*	*
Operating	±(5 to 18)V	*	*	±(5 to 22)V
Current, Quiescent	4mA max	3mA max	**	**
TEMPERATURE RANGE				
Operating Rated Performance	0 to +70°C	*	*	-55°C to +125°C
Storage	-65°C to +150°C	*	*	*

NOTES:

*Specifications same as AD510JH.

**Specifications same as AD510KH.

Specifications subject to change without notice.

**TYPICAL
NON-INVERTING AMPLIFIER CONFIGURATION**

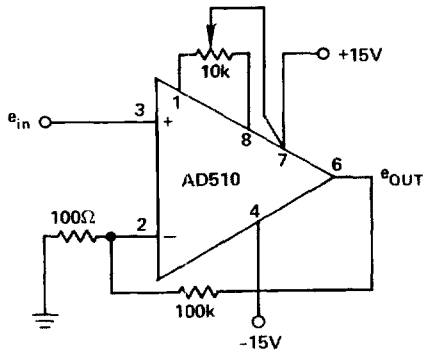

OUTLINE DIMENSIONS
Dimensions shown in inches and (mm).
TO-99

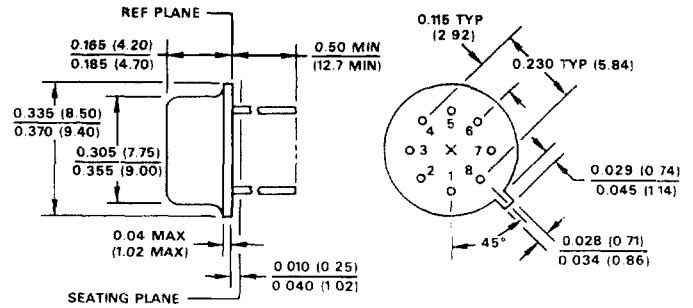

NULLING THE AD510

Nulling the AD510 can be achieved using the high resolution circuit of Figure 1.

1. Null the offset to zero using a commercially available pot (approximately 10kΩ).
2. Measure pot halves, R_1 and R_2 .
3. Calculate ... $R_1' = \frac{R_1 \times 50k\Omega}{50k\Omega - R_1}$ $R_2' = \frac{R_2 \times 50k\Omega}{50k\Omega - R_2}$
4. Insert R_1' and R_2' (closest 1% fixed metal film resistors).
5. Use an industrial quality 100kΩ pot (r_p) to fine tune the trim.

Nulling to within 1 microvolt can be achieved using this technique. For best results, the wiper of the potentiometer should be connected directly to pin 7 of the op amp.

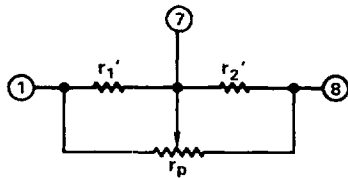

Figure 1. High Resolution, High Stability Nulling Circuit

THE AD510L IN A SIMPLE INSTRUMENTATION AMPLIFIER

The circuit of Figure 2 illustrates a simple instrumentation amplifier suitable for use with strain gauges, thermocouples and other transducers. It provides high input impedance to ground at each of the differential input terminals and excellent common mode rejection.

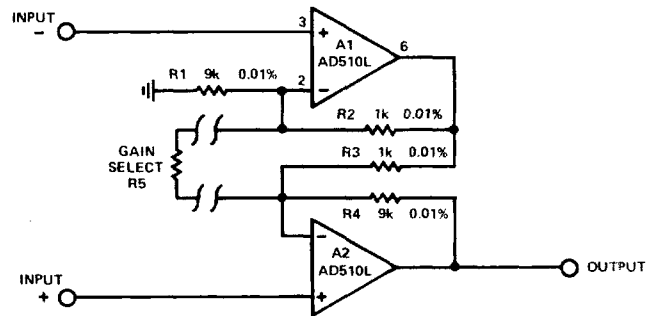

Figure 2. Instrumentation Amplifier

The configuration shown is designed for a gain of 10, however the gain can be varied upwards by adding a gain select resistor R_5 . In operation, amplifier A_1 provides a gain of 10/9 for signals at the negative input terminal. This output feeds the inverting amplifier A_2 , which has a gain of 9, resulting in an overall gain of 10. For signals at the positive input, the output of A_1 is at ground potential and the amplifier A_2 provides a gain of 10. Thus, the circuit has a gain of 10 for differential signals and 0 for common mode signals; the very high CMRR and open loop gain of the AD510L automatically produces common mode rejection of at least 25,000 at dc at a gain of 10 and over 1,000,000 at a gain of 1000. The common mode rejection, of course, depends upon the resistor ratios and their specified tolerance. Less accurate resistors can be used if the network is trimmed.

For gains of 10 the frequency response is down 3dB at 500kHz, for gains of 1000, 2kHz. Full output of $\pm 10V$ can be attained up to 1800Hz.

The common mode rejection at 60Hz is limited by the finite gain bandwidth of A_1 causing a phase lag on the negative input signal. At 60Hz the CMRR measures 72dB at a gain of 1000 and 62dB at a gain of 10.

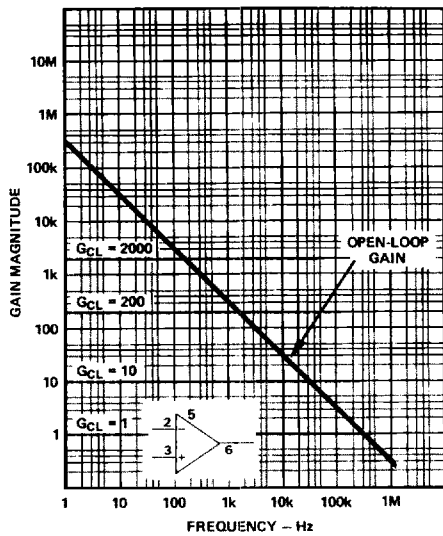

Figure 3. Small Signal Gain vs. Frequency

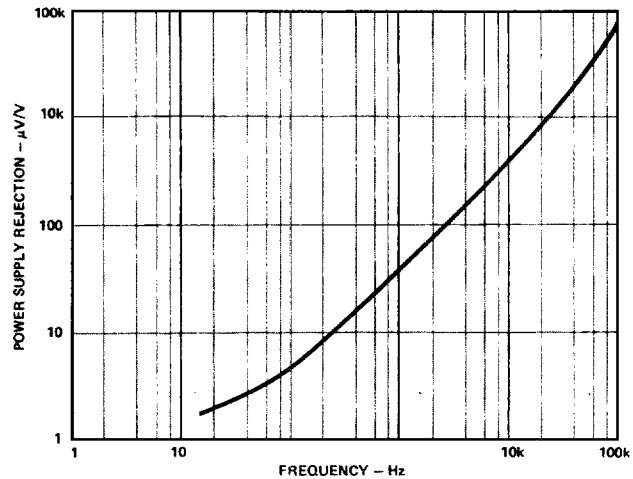

Figure 4. PSRR vs. Frequency

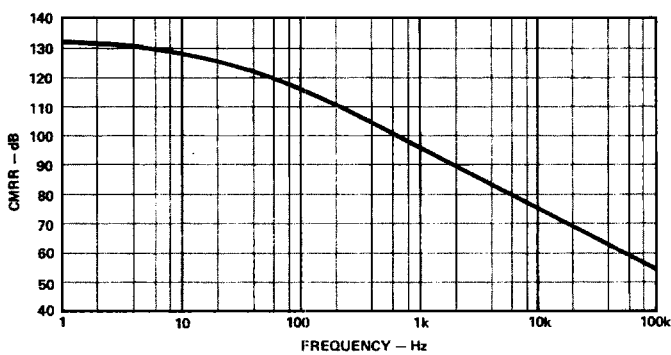

Figure 5. CMRR vs. Frequency

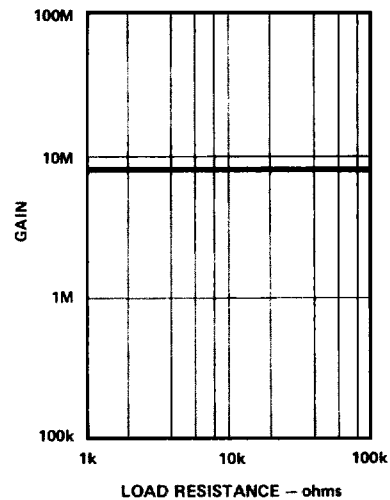

Figure 6. Gain vs. Load Resistance

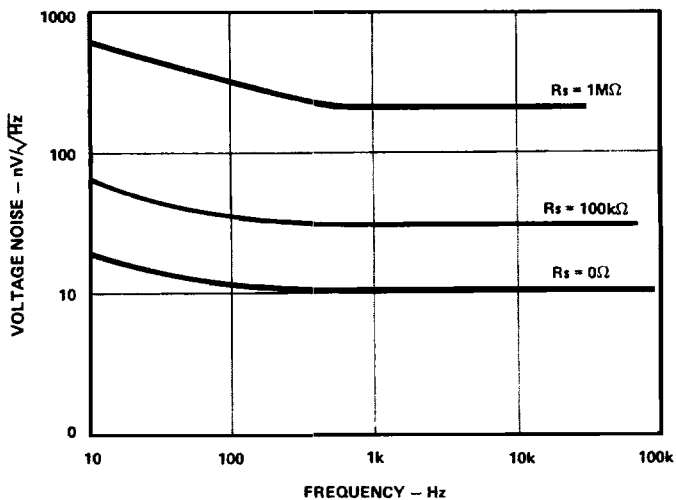

Figure 7. Voltage Noise vs. Frequency

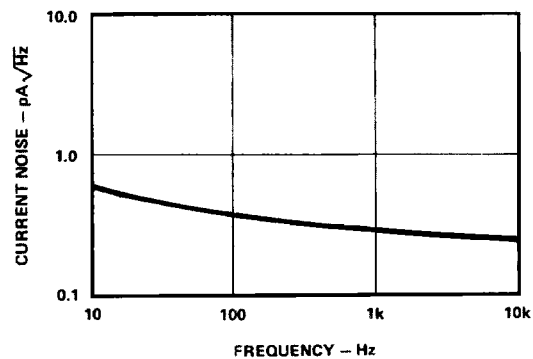

Figure 8. Current Noise vs. Frequency

