

V Series Power & Line Voltage Select Slide Switches

Features/Benefits

- Ratings up to 10 AMPS
- Snap-in panel and PC mounting
- Actuators with screwdriver slot
- Quick connect terminals available
- RoHS compliant

Typical Applications

- Appliances



Specifications

CONTACT RATING: 10 GPA @ 125 V AC 50/60 Hz T85;
 5 GPA @ 250 V AC 50/60 Hz T85;
 2 (0.5)A @ 250 VAC 50/60 Hz T85;
 4RA @ 30 VDC T85

ELECTRICAL LIFE: 10,000 make-and-break cycles at full load.

CONTACT RESISTANCE: Below 10 m Ω typ. initial
 @ 2-4 V DC, 100 mA.

INSULATION RESISTANCE: 10⁹ Ω min.

DIELECTRIC STRENGTH: 1,000 Vrms min. @ sea level.

OPERATING TEMPERATURE: -30°C to +85°C.

Materials

HOUSING: 6/6 nylon (UL94V-2), black.

TOP PLATE: 6/6 nylon (UL94V-2), black.

ACTUATOR: Glass filled polyester (UL94V-0), '01 and 02' styles, black (standard); '12, 13 and 14' styles, red (standard).

CONTACTS: Copper, silver plated.

TERMINALS: Copper, silver plated.

CONTACT SPRING: Music wire or stainless steel.

TERMINAL SEAL: Epoxy.

NOTE: Any models supplied with Q, B or G contact material are RoHS compliant.

NOTE: Specifications and materials listed above are for switches with standard options. For information on specific and custom switches, consult Customer Service Center.



Slide

Build-A-Switch

To order, simply select desired option from each category and place in the appropriate box. Available options are shown and described on pages I-34 through I-36. For additional options not shown in catalog, consult Customer Service Center.

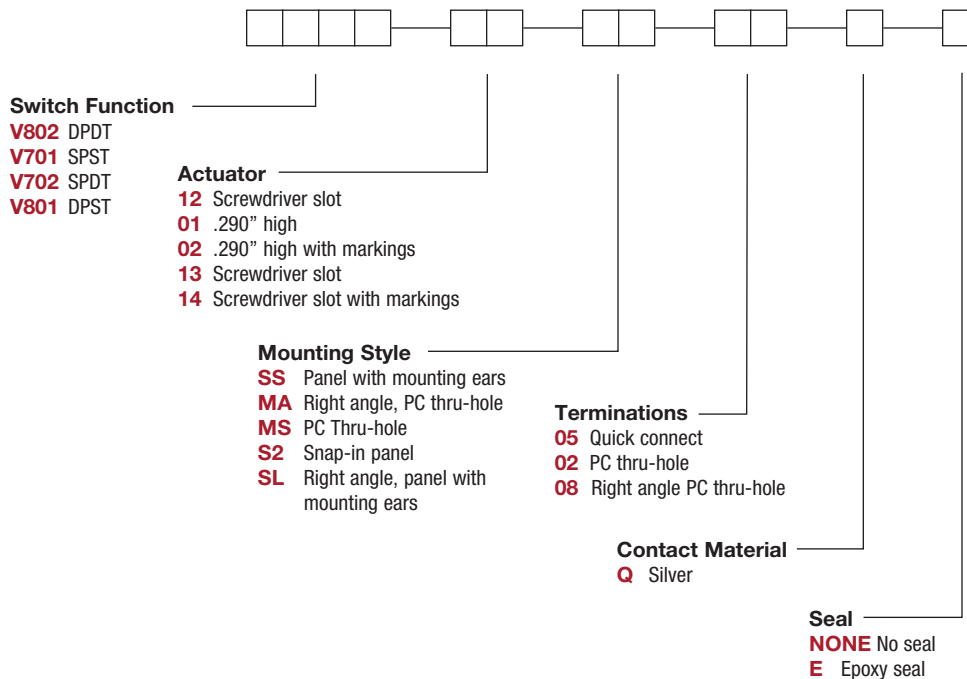

V Series Power & Line Voltage Select Slide Switches

SWITCH FUNCTION

NO. POLES	MODEL NO.	SWITCH FUNCTION	SCHEMATIC	AVAILABLE MOUNTING STYLES
SP	V701	SPST		ALL
	V702	SPDT		ALL

All models with all options.



Contacts make on side actuator thrown.

NO. POLES	MODEL NO.	SWITCH FUNCTION	SCHEMATIC	AVAILABLE MOUNTING STYLES
DP	V801	DPST		ALL
	V802	DPDT		ALL

ACTUATOR

12 SCREWDRIVER SLOT WITH MARKING

01 .290" HIGH

02 .290" HIGH WITH MARKINGS

13 SCREWDRIVER SLOT NO MARKING

14 SCREWDRIVER SLOT WITH MARKINGS

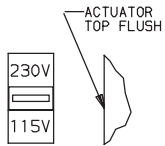

Actuator color is red with white 115V-230V markings (std.).

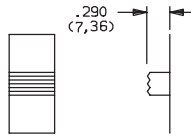

Actuator color is black.

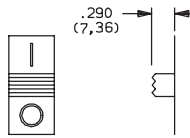

markings are reversed on V702 and V802 models. Actuator color is black with white markings (std.).

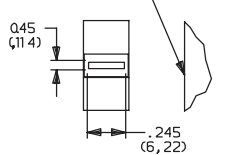

Actuator color is red.

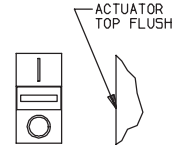

Markings are reversed on V702 and V802 models. Actuator color is red with white markings (std.). **Note:** Orientation of actuator markings and terminals.

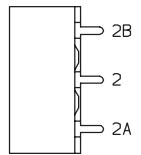

MOUNTING STYLE

SS PANEL WITH MOUNTING EARS



V80212SS05Q
DPDT

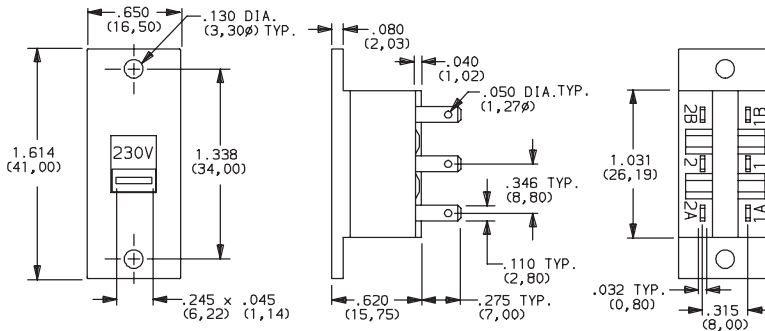

PANEL MOUNTING

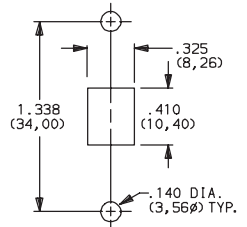

AVAILABLE WITH:
Models: All.
Terminations: 02 and 05

MA RIGHT ANGLE, PC THRU-HOLE



V80212MA08Q
Horizontal Actuation
DPDT

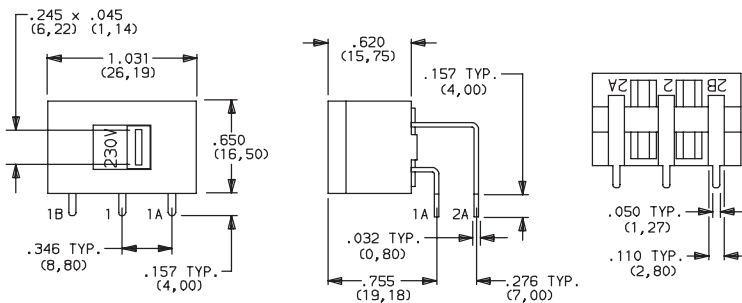

AVAILABLE WITH:
Models: All
Terminations: 08

PC MOUNTING
PC mount, side actuated.
For mounting information, see TERMINATIONS section, page I-36.



Dimensions are shown: Inch (mm)

Specifications and dimensions subject to change



V Series Power & Line Voltage Select Slide Switches

MOUNTING STYLE

MS PC THRU-HOLE

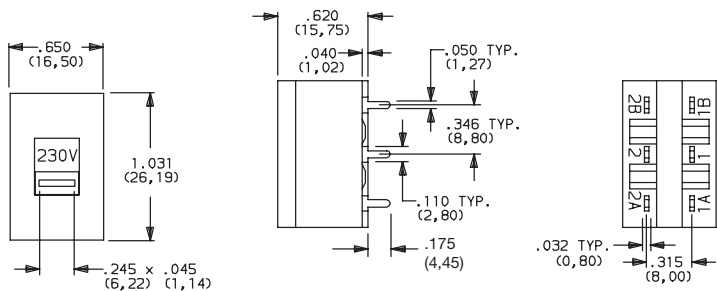

AVAILABLE WITH:
All models with 02 terminations

PC MOUNTING
PC mount, top actuated.
For mounting information,
see TERMINATIONS section, page I-36.



V80212MS02Q
DPDT

SL RIGHT ANGLE PANEL WITH MOUNTING EARS

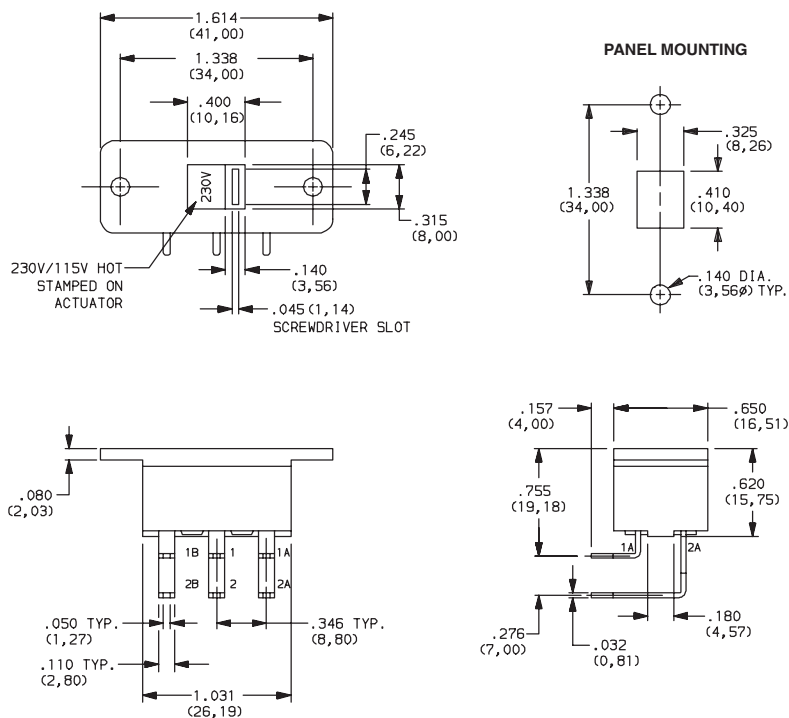

AVAILABLE WITH:
All models with 08 terminations

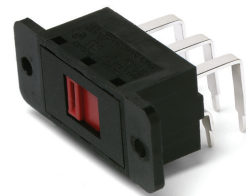

V80213SL08Q
Horizontal Actuation
DPDT

S2 SNAP-IN PANEL MOUNT

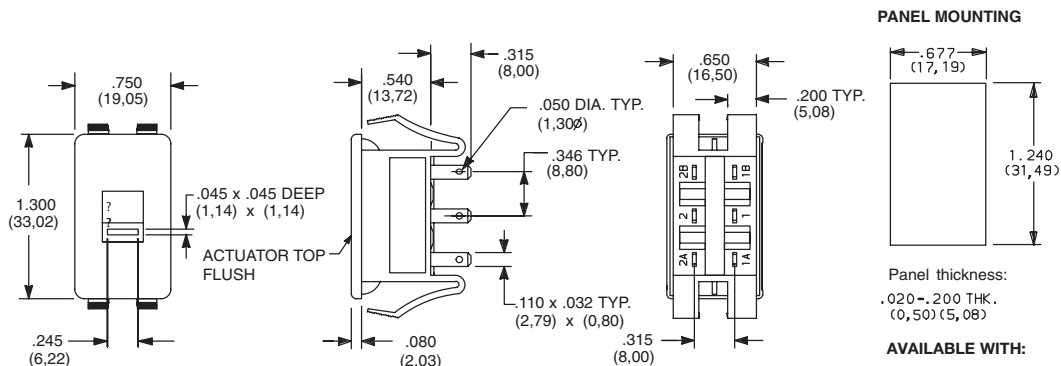

PANEL MOUNTING

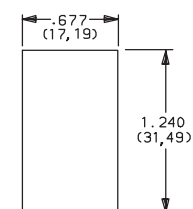

Panel thickness:
.020-.200 THK.
(0,50) (5,08)

AVAILABLE WITH:
All models with 02 &
05 terminations



V80212S205Q
DPDT

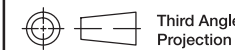

Dimensions are shown: Inches (mm)
Specifications and dimensions subject to change



Slide

V Series Power & Line Voltage Select Slide Switches

TERMINATIONS

05 QUICK CONNECT

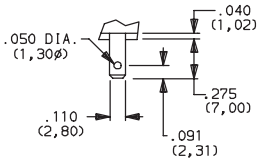

.032 THK.
(0,80)

Fits .110 in. quick connector.

02 PC THRU-HOLE

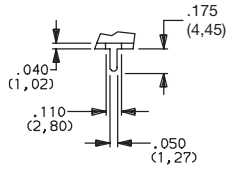

.032 THK.
(0,80)

PC MOUNTING

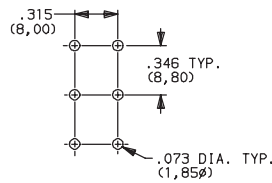

MS, SS Mounting Styles.

08 PC THRU-HOLE

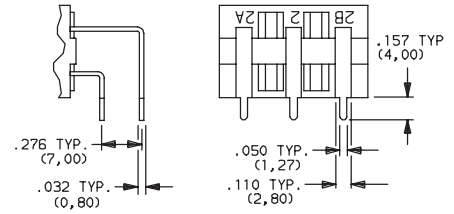

Not available with 'MS, SS or S2' mounting styles.

PC MOUNTING

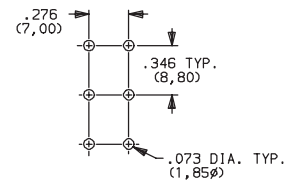

MA, SL Mounting Styles.

CONTACT MATERIAL

OPTION CODE	CONTACT MATERIAL	RATINGS	
Q	SILVER ¹	POWER	10 GPA @ 125 V AC 50/60 Hz T85; 5 GPA @ 250 V AC 50/60 Hz T85; 2 (0.5)A @ 250 VAC 50/60 Hz T85; 4RA @ 30 VDC T85

* Note: See Technical Data section of this catalog for RoHS compliant and compatible definitions and specifications.

¹ CONTACTS & TERMINALS: Copper, silver plated (standard with all termination options).

All models   with all options.

NOTE: Any models supplied with Q contact material are RoHS compliant.

SEAL

NONE NO SEAL

E EPOXY SEAL

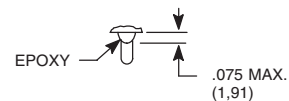

Third Angle
Projection

Dimensions are shown: Inch (mm)
Specifications and dimensions subject to change