

# 54AC/74AC11

## Triple 3-Input AND Gate

### General Description

The 'AC11 contains three 3-input AND gates.

### Features

- $I_{CC}$  reduced by 50%
- Outputs source/sink 24 mA
- Standard Military Drawing (SMD)
- 'AC11: 5962-87611

### Logic Symbol

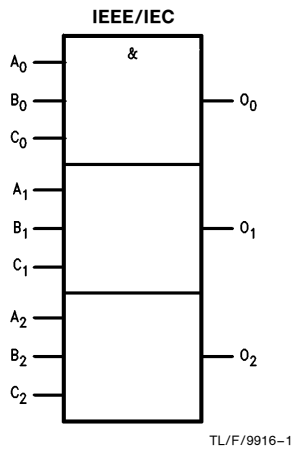

### Connection Diagrams

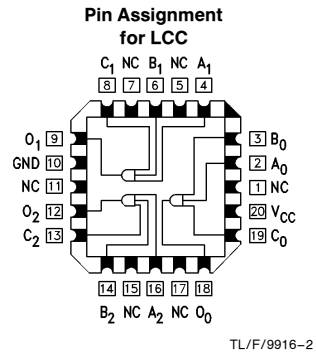
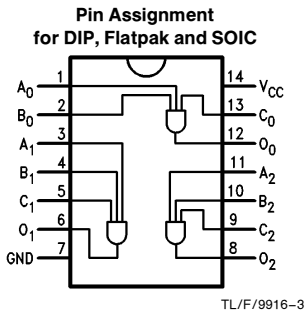

Pin Names	Description
$A_n, B_n, C_n$	Inputs
$O_n$	Outputs

## Absolute Maximum Rating (Note 1)

If Military/Aerospace specified devices are required, please contact the National Semiconductor Sales Office/Distributors for availability and specifications.

Supply Voltage ( $V_{CC}$ )	-0.5V to +7.0V
DC Input Diode Current ( $I_{IK}$ )	
$V_I = -0.5V$	-20 mA
$V_I = V_{CC} + 0.5V$	+20 mA
DC Input Voltage ( $V_I$ )	-0.5V to $V_{CC} + 0.5V$
DC Output Diode Current ( $I_{OK}$ )	
$V_O = -0.5V$	-20 mA
$V_O = V_{CC} + 0.5V$	+20 mA
DC Output Voltage ( $V_O$ )	-0.5V to $V_{CC} + 0.5V$
DC Output Source or Sink Current ( $I_O$ )	$\pm 50$ mA
DC $V_{CC}$ or Ground Current per Output Pin ( $I_{CC}$ or $I_{GND}$ )	$\pm 50$ mA
Storage Temperature ( $T_{STG}$ )	-65°C to +150°C
Junction Temperature ( $T_J$ )	
CDIP	175°C
PDIP	140°C

**Note 1:** Absolute maximum ratings are those values beyond which damage to the device may occur. The databook specifications should be met, without exception, to ensure that the system design is reliable over its power supply, temperature, and output/input loading variables. National does not recommend operation of FACT™ circuits outside databook specifications.

## Recommended Operating Conditions

Supply Voltage ( $V_{CC}$ )	2.0V to 6.0V
'AC	
Input Voltage ( $V_I$ )	0V to $V_{CC}$
Output Voltage ( $V_O$ )	0V to $V_{CC}$
Operating Temperature ( $T_A$ )	
74AC	-40°C to +85°C
54AC	-55°C to +125°C
Minimum Input Edge Rate ( $\Delta V/\Delta t$ )	
'AC Devices	
$V_{IN}$ from 30% to 70% of $V_{CC}$	
$V_{CC}$ @ 3.3V, 4.5V, 5.5V	125 mV/ns

## DC Characteristics for 'AC Family Devices

Symbol	Parameter	$V_{CC}$ (V)	74AC		54AC	74AC		Units	Conditions
			$T_A = +25^\circ\text{C}$		$T_A = -55^\circ\text{C to } +125^\circ\text{C}$	$T_A = -40^\circ\text{C to } +85^\circ\text{C}$			
			Typ	Guaranteed Limits					
$V_{IH}$	Minimum High Level Input Voltage	3.0	1.5	2.1	2.1	2.1	2.1	V	$V_{OUT} = 0.1V$ or $V_{CC} - 0.1V$
		4.5	2.25	3.15	3.15	3.15	3.15		
		5.5	2.75	3.85	3.85	3.85	3.85		
$V_{IL}$	Maximum Low Level Input Voltage	3.0	1.5	0.9	0.9	0.9	0.9	V	$V_{OUT} = 0.1V$ or $V_{CC} - 0.1V$
		4.5	2.25	1.35	1.35	1.35	1.35		
		5.5	2.75	1.65	1.65	1.65	1.65		
$V_{OH}$	Minimum High Level Output Voltage	3.0	2.99	2.9	2.9	2.9	2.9	V	$I_{OUT} = -50 \mu\text{A}$
		4.5	4.49	4.4	4.4	4.4	4.4		
		5.5	5.49	5.4	5.4	5.4	5.4		
		3.0		2.56	2.4	2.46	2.46	V	* $V_{IN} = V_{IL}$ or $V_{IH}$ -12 mA $I_{OH} = -24$ mA -24 mA
		4.5		3.86	3.7	3.76	3.76		
5.5		4.86	4.7	4.76	4.76				
$V_{OL}$	Maximum Low Level Output Voltage	3.0	0.002	0.1	0.1	0.1	0.1	V	$I_{OUT} = 50 \mu\text{A}$
		4.5	0.001	0.1	0.1	0.1	0.1		
		5.5	0.001	0.1	0.1	0.1	0.1		
		3.0		0.36	0.5	0.44	0.44	V	* $V_{IN} = V_{IL}$ or $V_{IH}$ 12 mA $I_{OL} = 24$ mA 24 mA
		4.5		0.36	0.5	0.44	0.44		
5.5		0.36	0.5	0.44	0.44				
$I_{IN}$	Maximum Input Leakage Current	5.5		$\pm 0.1$	$\pm 1.0$	$\pm 1.0$	$\mu\text{A}$	$V_I = V_{CC}, \text{GND}$	

\*All outputs loaded; thresholds on input associated with output under test.

## DC Characteristics for 'AC Family Devices (Continued)

Symbol	Parameter	V <sub>CC</sub> (V)	74AC		54AC	74AC		Units	Conditions
			T <sub>A</sub> = +25°C		T <sub>A</sub> = -55°C to +125°C	T <sub>A</sub> = -40°C to +85°C			
			Typ	Guaranteed Limits					
I <sub>OLD</sub>	†Minimum Dynamic Output Current	5.5			50		75	mA	V <sub>OLD</sub> = 1.65V Max
I <sub>OHD</sub>		5.5			-50		-75	mA	V <sub>OHD</sub> = 3.85V Min
I <sub>CC</sub>	Maximum Quiescent Supply Current	5.5		2.0	40.0		20.0	μA	V <sub>IN</sub> = V <sub>CC</sub> or GND

†Maximum test duration 2.0 ms, one output loaded at a time.

**Note:** I<sub>IN</sub> and I<sub>CC</sub> @ 3.0V are guaranteed to be less than or equal to the respective limit @ 5.5V V<sub>CC</sub>.

I<sub>CC</sub> for 54AC @ 25°C is identical to 74AC @ 25°C.

## AC Characteristics

Symbol	Parameter	V <sub>CC</sub> * (V)	74AC			54AC		74AC		Units
			T <sub>A</sub> = +25°C C <sub>L</sub> = 50 pF			T <sub>A</sub> = -55°C to +125°C C <sub>L</sub> = 50 pF		T <sub>A</sub> = -40°C to +85°C C <sub>L</sub> = 50 pF		
			Min	Typ	Max	Min	Max	Min	Max	
t <sub>PLH</sub>	Propagation Delay	3.3	1.5	5.5	9.5	1.0	11.0	1.0	10.0	ns
			5.0	1.5	4.0	8.0	1.0	8.5	1.0	
t <sub>PHL</sub>	Propagation Delay	3.3	1.5	5.5	8.5	1.0	10.5	1.0	9.5	ns
			5.0	1.5	4.0	7.0	1.0	8.0	1.0	

\*Voltage Range 3.3 is 3.3V ±0.3V  
Voltage Range 5.0 is 5.0V ±0.5V

## Capacitance

Symbol	Parameter	Typ	Units	Conditions
C <sub>IN</sub>	Input Capacitance	4.5	pF	V <sub>CC</sub> = OPEN
C <sub>PD</sub>	Power Dissipation Capacitance	20.0	pF	V <sub>CC</sub> = 5.0V

## Ordering Information

The device number is used to form part of a simplified purchasing code where the package type and temperature range are defined as follows:

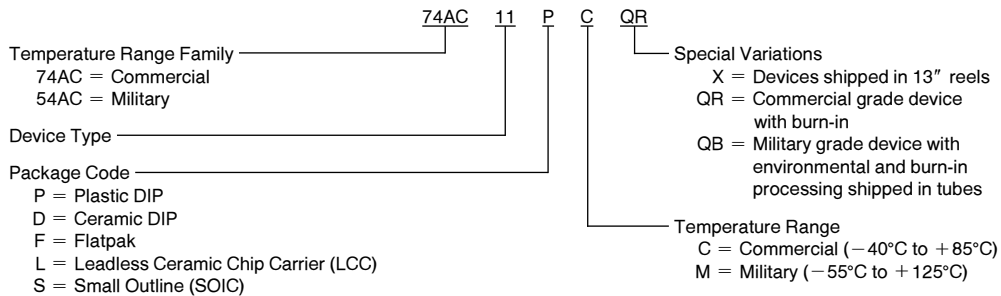

**Physical Dimensions** inches (millimeters)

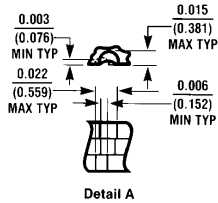
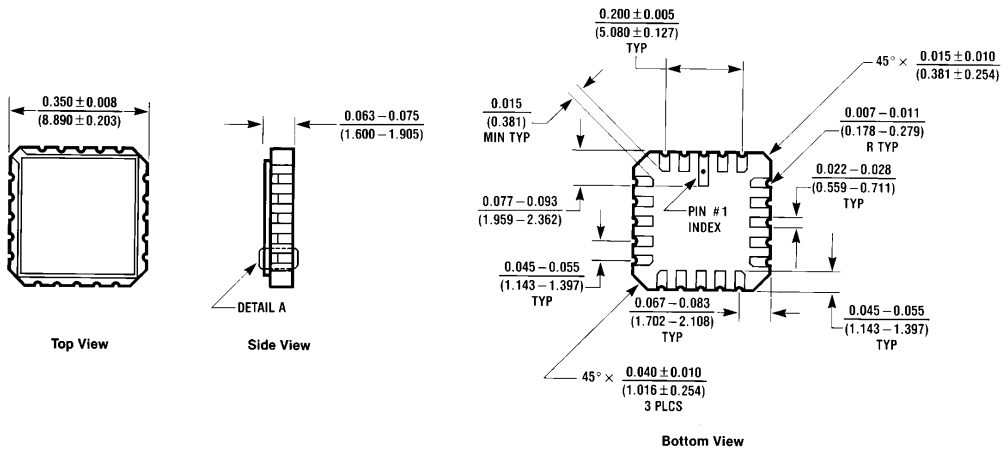

**20 Terminal Ceramic Leadless Chip Carrier (L)**  
NS Package Number E20A

E20A (REV D)

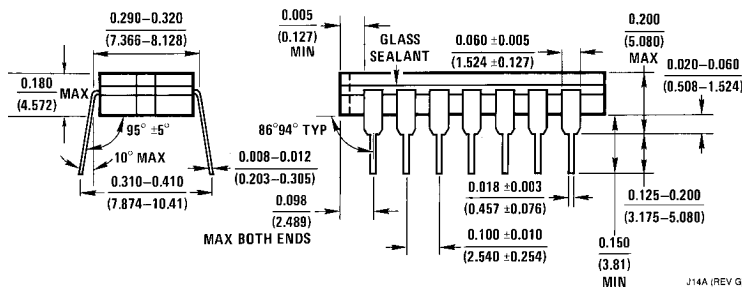
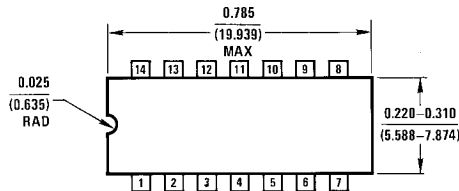

**14 Lead Ceramic Dual-In-Line Package (D)**  
NS Package Number J14A

J14A (REV G)

**Physical Dimensions** inches (millimeters) (Continued)

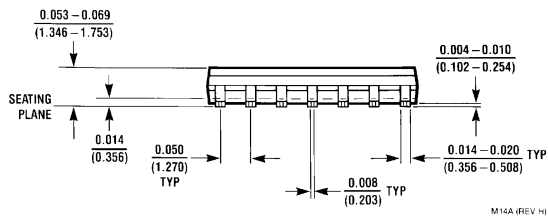
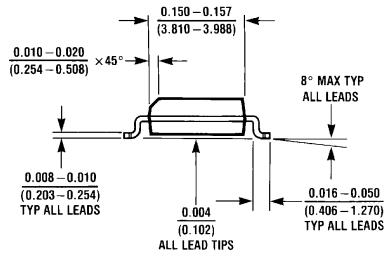
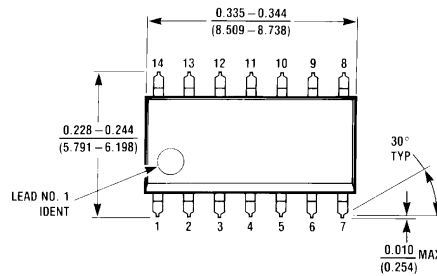

**14 Lead Small Outline Integrated Circuit (S)  
NS Package Number M14A**

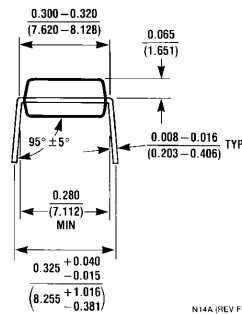
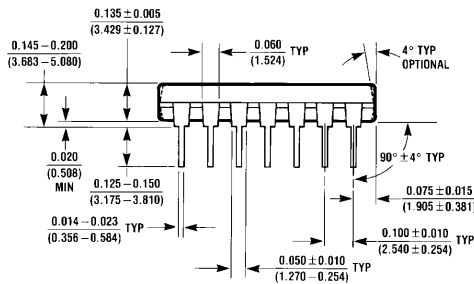
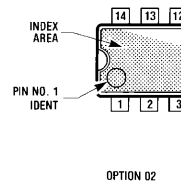
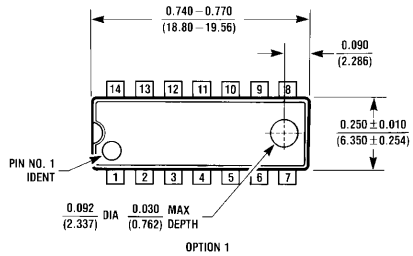

**14 Lead Plastic Dual-In-Line Package (P)  
NS Package Number N14A**

**Physical Dimensions** inches (millimeters) (Continued)

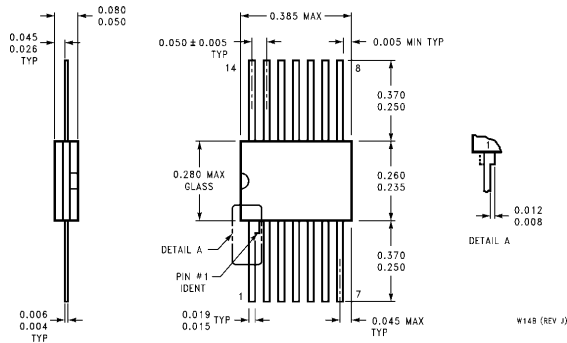

**14 Lead Ceramic Flatpak (F)  
NS Package Number W14B**

**LIFE SUPPORT POLICY**

NATIONAL'S PRODUCTS ARE NOT AUTHORIZED FOR USE AS CRITICAL COMPONENTS IN LIFE SUPPORT DEVICES OR SYSTEMS WITHOUT THE EXPRESS WRITTEN APPROVAL OF THE PRESIDENT OF NATIONAL SEMICONDUCTOR CORPORATION. As used herein:

1. Life support devices or systems are devices or systems which, (a) are intended for surgical implant into the body, or (b) support or sustain life, and whose failure to perform, when properly used in accordance with instructions for use provided in the labeling, can be reasonably expected to result in a significant injury to the user.
2. A critical component is any component of a life support device or system whose failure to perform can be reasonably expected to cause the failure of the life support device or system, or to affect its safety or effectiveness.



**National Semiconductor Corporation**  
1111 West Bardin Road  
Arlington, TX 76017  
Tel: 1(800) 272-9959  
Fax: 1(800) 737-7018

**National Semiconductor Europe**  
Fax: (+49) 0-180-530 85 86  
Email: cnjwge@tevm2.nsc.com  
Deutsch Tel: (+49) 0-180-530 85 85  
English Tel: (+49) 0-180-532 78 32  
Français Tel: (+49) 0-180-532 93 58  
Italiano Tel: (+49) 0-180-534 16 80

**National Semiconductor Hong Kong Ltd.**  
19th Floor, Straight Block,  
Ocean Centre, 5 Canton Rd.  
Tsimshatsui, Kowloon  
Hong Kong  
Tel: (852) 2737-1600  
Fax: (852) 2736-9960

**National Semiconductor Japan Ltd.**  
Tel: 81-043-299-2309  
Fax: 81-043-299-2408

National does not assume any responsibility for use of any circuitry described, no circuit patent licenses are implied and National reserves the right at any time without notice to change said circuitry and specifications.