



STD15NF10

N-channel 100 V, 0.060 Ω , 23 A, DPAK
low gate charge STripFET™ II Power MOSFET

Features

Type	V _{DSS}	R _{DS(on)} max	I _D
STD15NF10	100 V	< 0.065 Ω	23 A

- Exceptional dv/dt capability
- 100% avalanche tested
- Application oriented characterization

Application

- Switching applications

Description

This MOSFET series realized with STMicroelectronics unique STripFET process has specifically been designed to minimize input capacitance and gate charge. It is therefore suitable as primary switch in advanced high-efficiency, high-frequency isolated DC-DC converters for telecom and computer applications. It is also intended for any applications with low gate drive requirements.

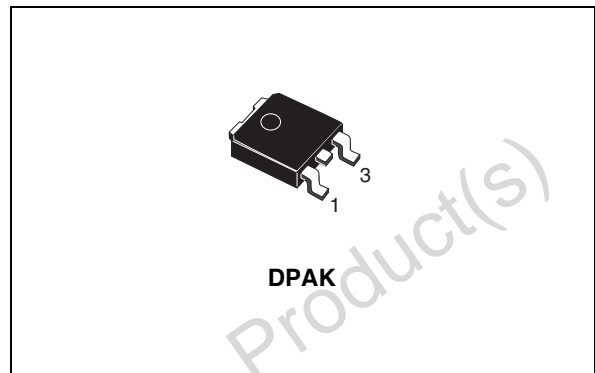

Figure 1. Internal schematic diagram

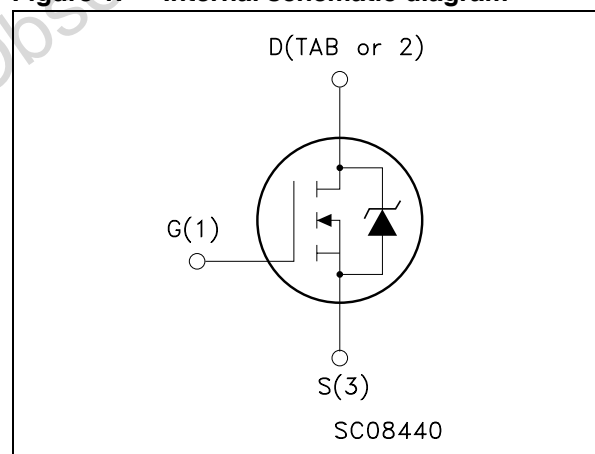

Table 1. Device summary

Order code	Marking	Package	Packaging
STD15NF10T4	D15NF10	DPAK	Tape and reel

Contents

1	Electrical ratings	3
2	Electrical characteristics	4
2.1	Electrical characteristics (curves)	6
3	Test circuit	8
4	Package mechanical data	9
5	Packaging mechanical data	11
6	Revision history	12

Obsolete Product(s) - Obsolete Product(s)

1 Electrical ratings

Table 2. Absolute maximum ratings

Symbol	Parameter	Value	Unit
V_{DS}	Drain-source voltage ($V_{GS} = 0$)	100	V
V_{DGR}	Drain-gate voltage ($R_{GS} = 20 \text{ k}\Omega$)	100	V
V_{GS}	Gate-source voltage	± 20	V
I_D	Drain current (continuous) at $T_C = 25 \text{ }^\circ\text{C}$	23	A
I_D	Drain current (continuous) at $T_C = 100 \text{ }^\circ\text{C}$	16	A
$I_{DM}^{(1)}$	Drain current (pulsed)	92	A
P_{TOT}	Total dissipation at $T_C = 25 \text{ }^\circ\text{C}$	70	W
	Derating factor	0.46	W/ $^\circ\text{C}$
$E_{AS}^{(2)}$	Single pulse avalanche energy	180	mJ
$dv/dt^{(3)}$	Peak diode recovery voltage slope	9	V/ns
T_{stg}	Storage temperature	-55 to 175	$^\circ\text{C}$
T_J	Max. operating junction temperature		

1. Pulse width limited by safe operating area
2. Starting $T_J = 25 \text{ }^\circ\text{C}$, $I_D = 10 \text{ A}$, $V_{DD} = 30 \text{ V}$
3. $I_{SD} \leq 13 \text{ A}$, $di/dt \leq 300 \text{ A}/\mu\text{s}$, $V_{DS} \leq V_{(BR)DSS}$, $T_J \leq T_{JMAX}$

Table 3. Thermal data

Symbol	Parameter	Value	Unit
R_{thJC}	Thermal resistance junction-case max	2.14	$^\circ\text{C}/\text{W}$
R_{thJA}	Thermal resistance junction-ambient max	100	$^\circ\text{C}/\text{W}$
T_I	Maximum lead temperature for soldering purpose	300	$^\circ\text{C}$

2 Electrical characteristics

($T_{CASE} = 25\text{ °C}$ unless otherwise specified)

Table 4. On⁽¹⁾ /off states

Symbol	Parameter	Test conditions	Min.	Typ.	Max.	Unit
$V_{(BR)DSS}$	Drain-source breakdown voltage	$I_D = 250\ \mu\text{A}$, $V_{GS} = 0$	100			V
I_{DSS}	Zero gate voltage drain current ($V_{GS} = 0$)	$V_{DS} = \text{Max rating}$ $V_{DS} = \text{Max rating, @ } 125\text{ °C}$			1 10	μA μA
I_{GSS}	Gate body leakage current ($V_{DS} = 0$)	$V_{GS} = \pm 20\ \text{V}$			± 100	nA
$V_{GS(th)}$	Gate threshold voltage	$V_{DS} = V_{GS}$, $I_D = 250\ \mu\text{A}$	2	3	4	V
$R_{DS(on)}$	Static drain-source on resistance	$V_{GS} = 10\ \text{V}$, $I_D = 12\ \text{A}$		0.06	0.065	Ω

1. Pulsed: Pulse duration = 300 μs , duty cycle 1.5%

Table 5. Dynamic

Symbol	Parameter	Test conditions	Min.	Typ.	Max.	Unit
$g_{fs}^{(1)}$	Forward transconductance	$V_{DS} = 15\ \text{V}$, $I_D = 7.5\ \text{A}$		12		S
C_{iss}	Input capacitance	$V_{DS} = 25\ \text{V}$, $f = 1\ \text{MHz}$, $V_{GS} = 0$		870		pF
C_{oss}	Output capacitance			125		pF
C_{rss}	Reverse transfer capacitance			50		pF
Q_g	Total gate charge	$V_{DD} = 80\ \text{V}$, $I_D = 24\ \text{A}$ $V_{GS} = 10\ \text{V}$		30	40	nC
Q_{gs}	Gate-source charge			6		nC
Q_{gd}	Gate-drain charge			10		nC

1. Pulsed: pulse duration=300 μs , duty cycle 1.5%

Table 6. Switching times

Symbol	Parameter	Test conditions	Min.	Typ.	Max.	Unit
$t_{d(on)}$	Turn-on delay time	$V_{DD} = 50\ \text{V}$, $I_D = 12\ \text{A}$, $R_G = 4.7\ \Omega$, $V_{GS} = 10\ \text{V}$ <i>Figure 13 on page 8</i>		60		ns
t_r	Rise time			45		ns
$t_{d(off)}$	Turn-off delay time			49		ns
t_f	Fall time			17		ns

Table 7. Source drain diode

Symbol	Parameter	Test conditions	Min	Typ.	Max	Unit
I_{SD}	Source-drain current				23	A
$I_{SDM}^{(1)}$	Source-drain current (pulsed)				92	A
$V_{SD}^{(2)}$	Forward on voltage	$I_{SD} = 20 \text{ A}$, $V_{GS} = 0$			1.5	V
t_{rr}	Reverse recovery time	$I_{SD} = 24 \text{ A}$, $di/dt = 100 \text{ A}/\mu\text{s}$, $V_{DD} = 30 \text{ V}$, $T_J = 150 \text{ }^\circ\text{C}$ <i>Figure 15 on page 8</i>		100		ns
Q_{rr}	Reverse recovery charge			375		nC
I_{RRM}	Reverse recovery current			7.5		A

1. Pulse width limited by safe operating area.
2. Pulsed: pulse duration = 300 μs , duty cycle 1.5%

2.1 Electrical characteristics (curves)

Figure 2. Safe operating area

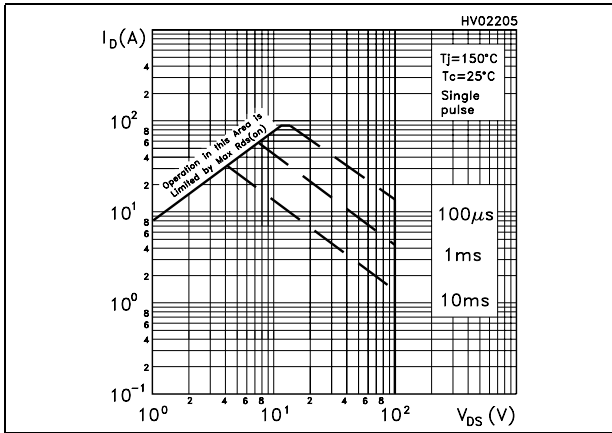

Figure 3. Thermal impedance

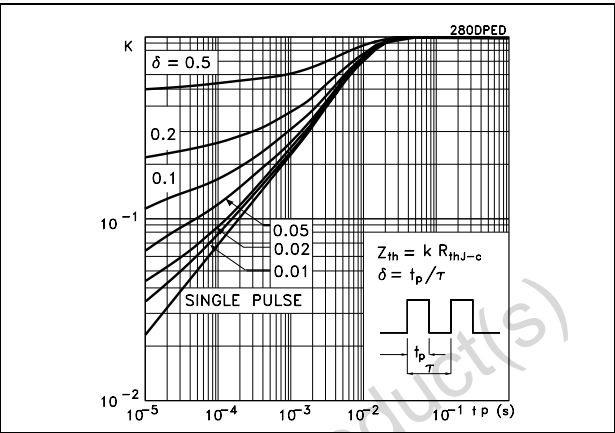

Figure 4. Output characteristics

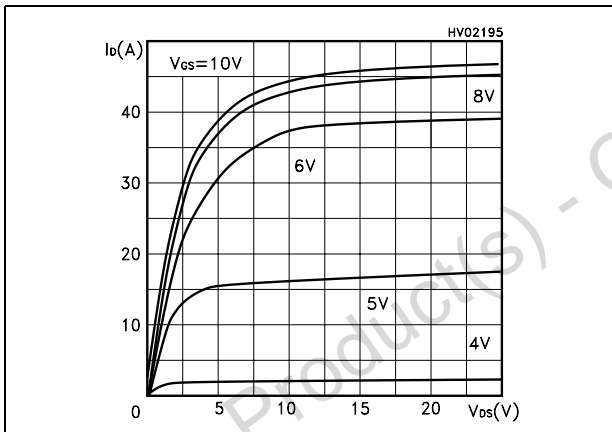

Figure 5. Transfer characteristics

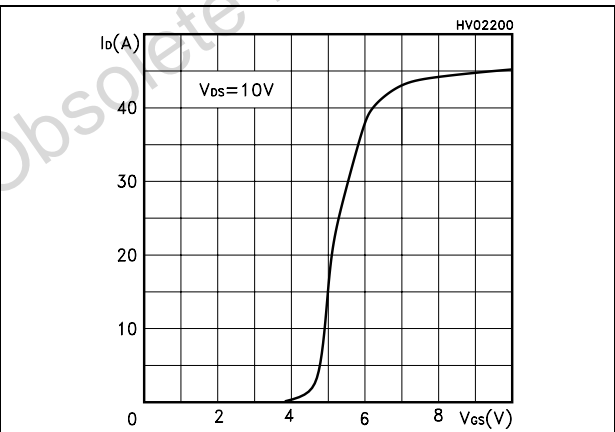

Figure 6. Transconductance

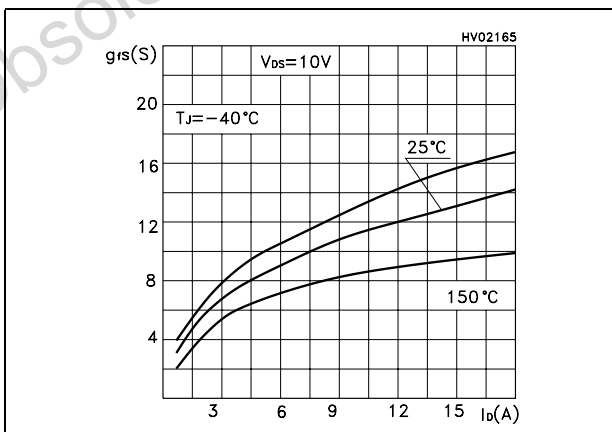

Figure 7. Static drain-source on resistance

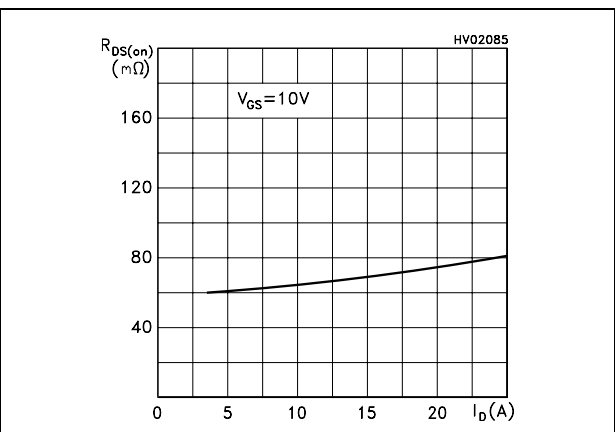

Figure 8. Gate charge vs. gate-source voltage Figure 9. Capacitance variations

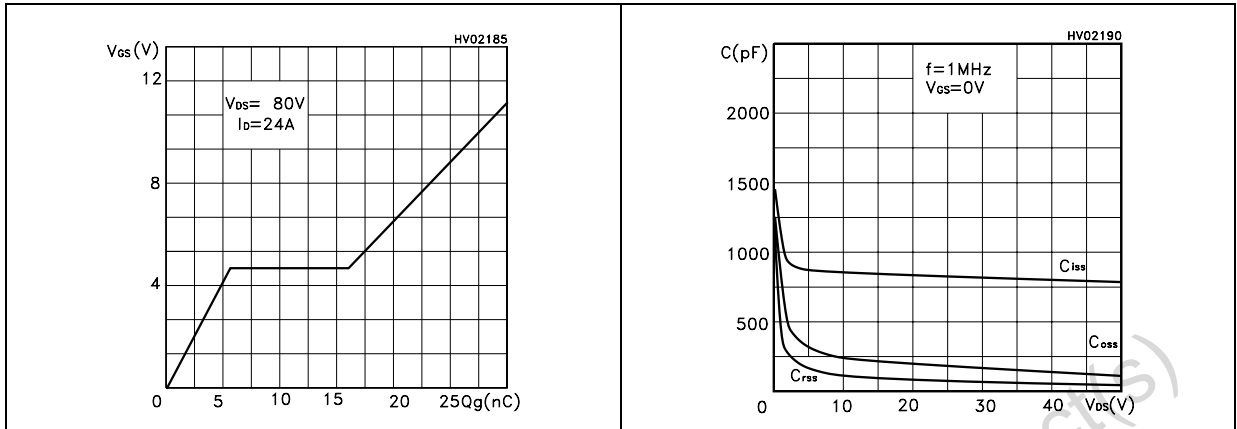

Figure 10. Normalized gate threshold voltage vs. temperature Figure 11. Normalized on resistance vs. temperature

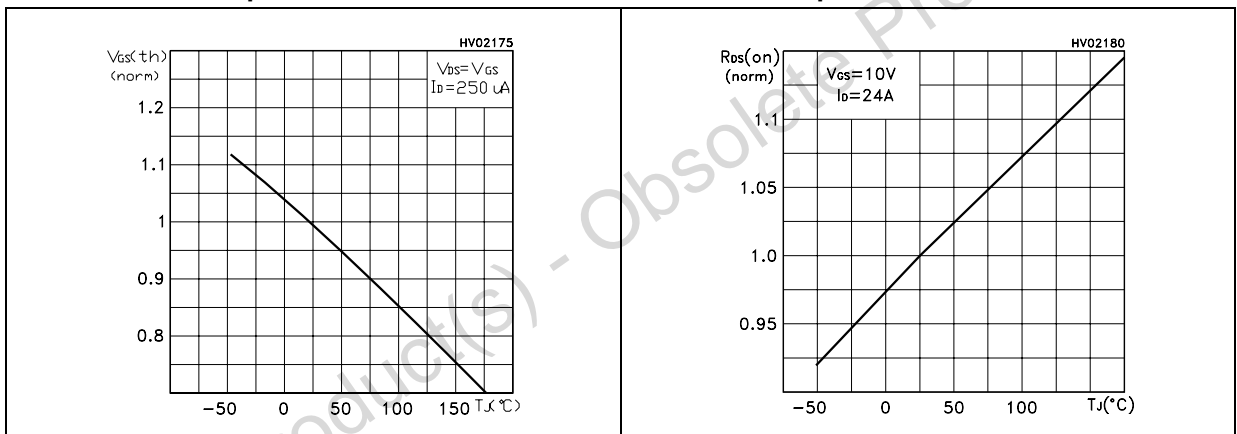
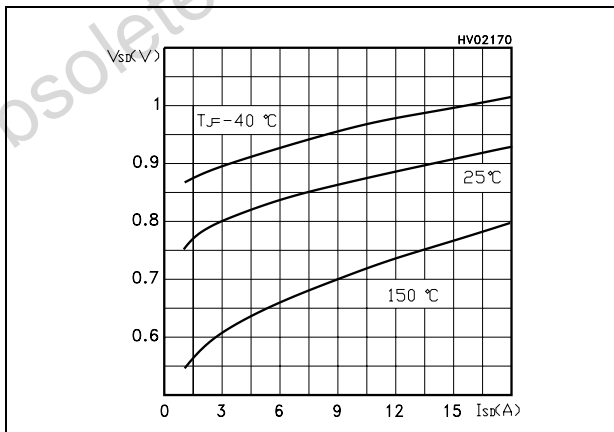

Figure 12. Source-drain diode forward characteristics



3 Test circuit

Figure 13. Switching times test circuit for resistive load

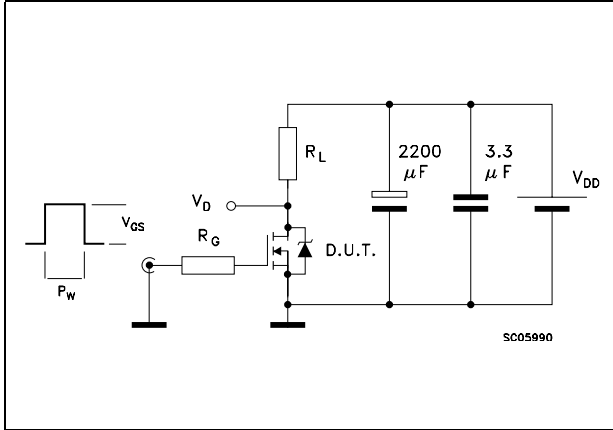

Figure 14. Gate charge test circuit

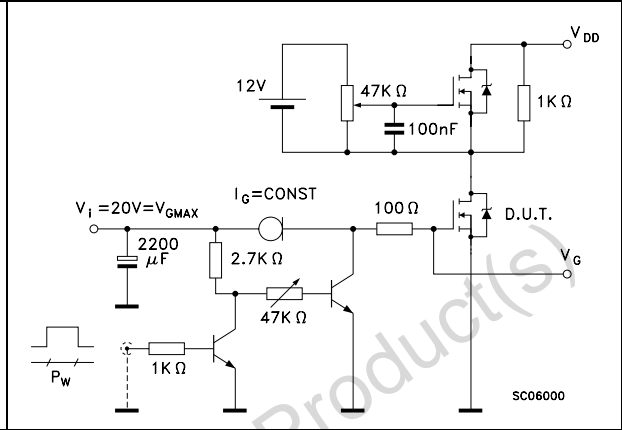

Figure 15. Test circuit for inductive load switching and diode recovery times

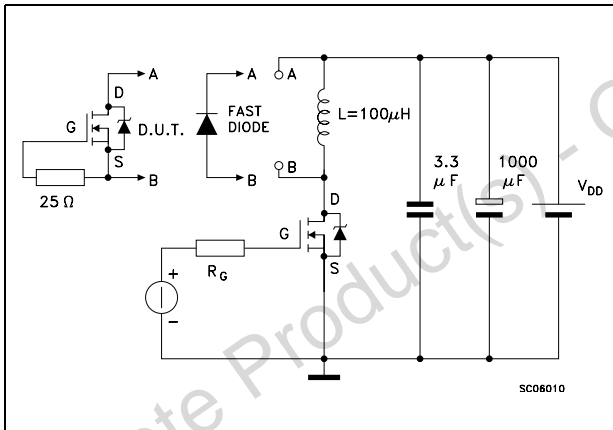

Figure 16. Unclamped Inductive load test circuit

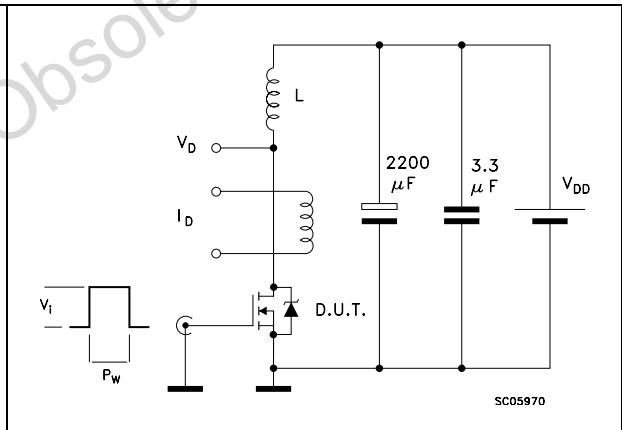
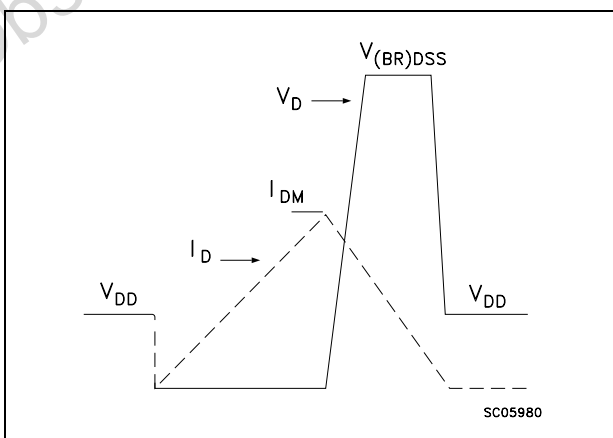

Figure 17. Unclamped inductive waveform



4 Package mechanical data

In order to meet environmental requirements, ST offers these devices in ECOPACK® packages. These packages have a Lead-free second level interconnect. The category of second level interconnect is marked on the package and on the inner box label, in compliance with JEDEC Standard JESD97. The maximum ratings related to soldering conditions are also marked on the inner box label. ECOPACK is an ST trademark. ECOPACK specifications are available at: www.st.com

Obsolete Product(s) - Obsolete Product(s)

TO-252 (DPAK) mechanical data

DIM.	mm.		
	min.	typ	max.
A	2.20		2.40
A1	0.90		1.10
A2	0.03		0.23
b	0.64		0.90
b4	5.20		5.40
c	0.45		0.60
c2	0.48		0.60
D	6.00		6.20
D1		5.10	
E	6.40		6.60
E1		4.70	
e		2.28	
e1	4.40		4.60
H	9.35		10.10
L	1		
L1		2.80	
L2		0.80	
L4	0.60		1
R		0.20	
V2	0°		8°

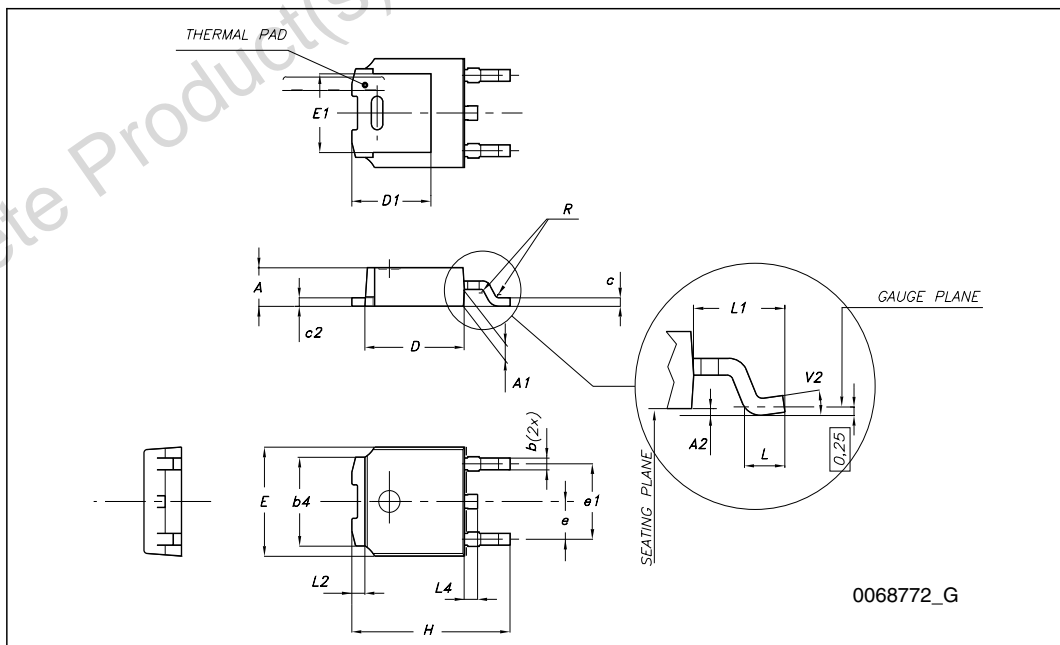

5 Packaging mechanical data

DPAK FOOTPRINT

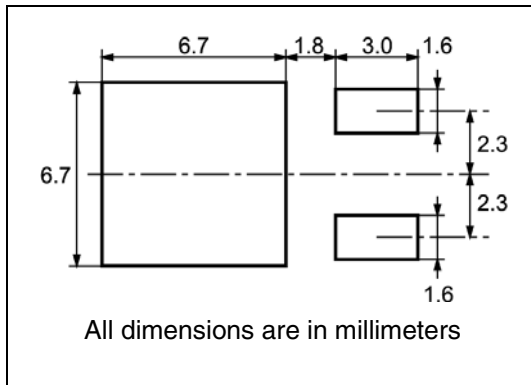

TAPE AND REEL SHIPMENT

40 mm min. Access hole at slot location

Full radius

Tape slot in core for tape start 2.5mm min. width

G measured at hub

DIM.	mm		inch	
	MIN.	MAX.	MIN.	MAX.
A		330		12.992
B	1.5		0.059	
C	12.8	13.2	0.504	0.520
D	20.2		0.795	
G	16.4	18.4	0.645	0.724
N	50		1.968	
T		22.4		0.881

BASE QTY	BULK QTY
2500	2500

DIM.	mm		inch	
	MIN.	MAX.	MIN.	MAX.
A0	6.8	7	0.267	0.275
B0	10.4	10.6	0.409	0.417
B1		12.1		0.476
D	1.5	1.6	0.059	0.063
D1	1.5		0.059	
E	1.65	1.85	0.065	0.073
F	7.4	7.6	0.291	0.299
K0	2.55	2.75	0.100	0.108
P0	3.9	4.1	0.153	0.161
P1	7.9	8.1	0.311	0.319
P2	1.9	2.1	0.075	0.082
R	40		1.574	
W	15.7	16.3	0.618	0.641

10 pitches cumulative tolerance on tape +/- 0.2 mm

Center line of cavity

For machine ref. only including draft and radii concentric around B0

TRL

FEED DIRECTION

Bending radius

R min.

6 Revision history

Table 8. Revision history

Date	Revision	Changes
21-Jun-2004	3	No history because migration.
09-Sep-2004	4	Complete document
08-Aug-2006	5	New template, updated SOA
04-Nov-2008	6	Q _G max value in Table 5 has been corrected.

Obsolete Product(s) - Obsolete Product(s)

Please Read Carefully:

Information in this document is provided solely in connection with ST products. STMicroelectronics NV and its subsidiaries ("ST") reserve the right to make changes, corrections, modifications or improvements, to this document, and the products and services described herein at any time, without notice.

All ST products are sold pursuant to ST's terms and conditions of sale.

Purchasers are solely responsible for the choice, selection and use of the ST products and services described herein, and ST assumes no liability whatsoever relating to the choice, selection or use of the ST products and services described herein.

No license, express or implied, by estoppel or otherwise, to any intellectual property rights is granted under this document. If any part of this document refers to any third party products or services it shall not be deemed a license grant by ST for the use of such third party products or services, or any intellectual property contained therein or considered as a warranty covering the use in any manner whatsoever of such third party products or services or any intellectual property contained therein.

UNLESS OTHERWISE SET FORTH IN ST'S TERMS AND CONDITIONS OF SALE ST DISCLAIMS ANY EXPRESS OR IMPLIED WARRANTY WITH RESPECT TO THE USE AND/OR SALE OF ST PRODUCTS INCLUDING WITHOUT LIMITATION IMPLIED WARRANTIES OF MERCHANTABILITY, FITNESS FOR A PARTICULAR PURPOSE (AND THEIR EQUIVALENTS UNDER THE LAWS OF ANY JURISDICTION), OR INFRINGEMENT OF ANY PATENT, COPYRIGHT OR OTHER INTELLECTUAL PROPERTY RIGHT.

UNLESS EXPRESSLY APPROVED IN WRITING BY AN AUTHORIZED ST REPRESENTATIVE, ST PRODUCTS ARE NOT RECOMMENDED, AUTHORIZED OR WARRANTED FOR USE IN MILITARY, AIR CRAFT, SPACE, LIFE SAVING, OR LIFE SUSTAINING APPLICATIONS, NOR IN PRODUCTS OR SYSTEMS WHERE FAILURE OR MALFUNCTION MAY RESULT IN PERSONAL INJURY, DEATH, OR SEVERE PROPERTY OR ENVIRONMENTAL DAMAGE. ST PRODUCTS WHICH ARE NOT SPECIFIED AS "AUTOMOTIVE GRADE" MAY ONLY BE USED IN AUTOMOTIVE APPLICATIONS AT USER'S OWN RISK.

Resale of ST products with provisions different from the statements and/or technical features set forth in this document shall immediately void any warranty granted by ST for the ST product or service described herein and shall not create or extend in any manner whatsoever, any liability of ST.

ST and the ST logo are trademarks or registered trademarks of ST in various countries.

Information in this document supersedes and replaces all information previously supplied.

The ST logo is a registered trademark of STMicroelectronics. All other names are the property of their respective owners.

© 2008 STMicroelectronics - All rights reserved

STMicroelectronics group of companies

Australia - Belgium - Brazil - Canada - China - Czech Republic - Finland - France - Germany - Hong Kong - India - Israel - Italy - Japan - Malaysia - Malta - Morocco - Singapore - Spain - Sweden - Switzerland - United Kingdom - United States of America

www.st.com