

22-Bit, Low-Power, 5MHz to 10MHz Serializer and Deserializer Chipsets

General Description

The MAX9223/MAX9224 serializer/deserializer chipsets reduce wiring by serializing 22 bits onto a single differential pair. 22 bits are serialized in each cycle of the parallel input clock resulting in a 110Mbps to 220Mbps net serial-data rate ideal for cell phone QVGA and QCIF displays. The MAX9223 serializes the 18-bit RGB, VSYNC, HSYNC, and two control signals from the baseband processor to reduce wiring through the hinge to the LCD controller. The 2-wire serial interface uses low-current differential signaling (LCDS) for low EMI, high common-mode noise immunity, and ground-shift tolerance. The MAX9223/MAX9224 automatically identify the word boundary in serial data in case of signal interruption. The MAX9224 power-down is controlled by the MAX9223. The MAX9223 and MAX9224 consume 3.5 μ A or less in power-down mode.

The MAX9223 serializer operates from a single +2.375V to +3.465V supply and accepts +1.71V to +3.465V inputs. The MAX9224 deserializer operates from a +2.375V to +3.465V core supply and has a separate output buffer supply (V_{DDO}), allowing +1.71V to +3.465V output high levels.

The MAX9223/MAX9224 are specified over the -40°C to +85°C extended temperature range and are available in 28-pin TQFN (4mm x 4mm x 0.8mm) packages with an exposed paddle.

Applications

Cell Phones
LCDs
Digital Cameras

Features

- ◆ Ideal for Serializing Cell Phone LCD or Imager Parallel Interface
- ◆ MAX9223 Serializes 18-Bit RGB, VSYNC, HSYNC, and Two Control Signals
- ◆ LCDS Rejects Common-Mode Noise
- ◆ Automatic Location of Word Boundary After Signal Interruption
- ◆ Power-Down Control Through the Serial Link
- ◆ Power-Down Supply Current
0.5 μ A (max)—MAX9223
3.0 μ A (max)—MAX9224
- ◆ +2.375V to +3.465V Core Supply Voltage
- ◆ Parallel I/O Interfaces Directly to 1.8V to 3.3V Logic
- ◆ \pm 15kV Human Body Model ESD Protection
- ◆ -40°C to +85°C Operating Temperature Range

Ordering Information

PART	TEMP RANGE	PIN-PACKAGE	PKG CODE
MAX9223ETI	-40°C to +85°C	28 TQFN-EP*	T2844-1
MAX9223ETI+	-40°C to +85°C	28 TQFN-EP*	T2844-1
MAX9224ETI	-40°C to +85°C	28 TQFN-EP*	T2844-1
MAX9224ETI+	-40°C to +85°C	28 TQFN-EP*	T2844-1

+Denotes lead-free package.

*EP = Exposed paddle.

Pin Configurations appear at end of data sheet.

Typical Application Circuit

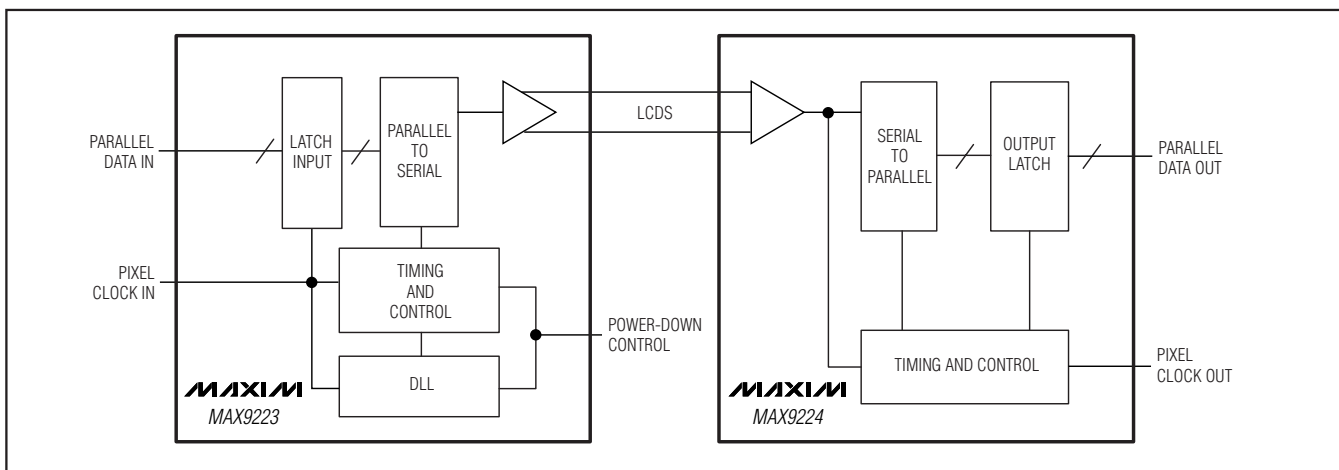

22-Bit, Low-Power, 5MHz to 10MHz Serializer and Deserializer Chipset

ABSOLUTE MAXIMUM RATINGS

V _{DD} to GND	-0.5V to +4.0V	Single-Layer PCB (derate 20.8mW/°C above +70°C).....	1667mW
V _{DDO} to GND.....	-0.5V to +4.0V	Storage Temperature Range	-65°C to +150°C
Serial Interface (SDO+, SDO-, SDI+, SDI-) to GND	-0.5V to +4.0V	Junction Temperature	+150°C
Single-Ended Inputs (DIN_, PCLKIN, PWRDN) to GND	-0.5V to (V _{DD} + 0.5V)	Lead Temperature (soldering, 10s)	+300°C
Single-Ended Outputs (DOUT_, PCLKOUT) to GND	-0.5V to (V _{DDO} + 0.5V)	ESD Protection (Human Body Model)	
Continuous Power Dissipation (T _A = +70°C)		SDO+, SDO-, SDI+, SDI- to GND	> ±15kV
28-Pin TQFN (4mm x 4mm x 0.8mm)		All Other Pins	> ±2kV
Multilayer PCB (derate 28.6mW/°C above +70°C).....	2286mW		

Stresses beyond those listed under "Absolute Maximum Ratings" may cause permanent damage to the device. These are stress ratings only, and functional operation of the device at these or any other conditions beyond those indicated in the operational sections of the specifications is not implied. Exposure to absolute maximum rating conditions for extended periods may affect device reliability.

DC ELECTRICAL CHARACTERISTICS—MAX9223

(V_{DD} = +2.375V to +3.465V, T_A = -40°C to +85°C, unless otherwise noted. Typical values are at V_{DD} = +2.5V, T_A = +25°C.) (Notes 1, 2)

PARAMETER	SYMBOL	CONDITIONS	MIN	TYP	MAX	UNITS
SINGLE-ENDED INPUTS (PCLKIN, DIN_, PWRDN)						
High-Level Input Voltage	V _{IH}		1.19	V _{DD} + 0.3		V
Low-Level Input Voltage	V _{IL}		-0.3	+0.3		V
Input Current	I _{IN}	V _{IN} = 0V to V _{DD}	-20		+20	μA
		-0.3V ≤ V _{IN} < 0V	-100		+100	
		V _{DD} < V _{IN} ≤ (V _{DD} + 0.3V)				
LCDS OUTPUT (SDO+, SDO-)						
Differential Output Current (Note 3)	I _{ODH}	High level	600	643	880	μA
	I _{ODL}	Low level	200	229	300	
Output Short-Circuit Current	I _{OS}	Shorted to 0V or V _{DD}			880	μA
POWER SUPPLY						
Supply Current	I _{DD}	V _{DD} = 2.5V, DIN_ = all low or all high	PCLKIN = 5MHz (110Mbps)	4.4	8.2	mA
			PCLKIN = 10MHz (220Mbps)	5.6	8.2	
Worst-Case Pattern Supply Current	I _{DDW}	V _{DD} = 2.5V, Figure 1	PCLKIN = 5MHz (110Mbps)	4.1	10.6	mA
			PCLKIN = 10MHz (220Mbps)	5.4	10.6	
Power-Down Supply Current	I _{DDZ}	All inputs = low			0.5	μA

22-Bit, Low-Power, 5MHz to 10MHz Serializer and Deserializer Chipset

MAX9223/MAX9224

DC ELECTRICAL CHARACTERISTICS—MAX9224

($V_{DD} = +2.375V$ to $+3.465V$, $V_{DDO} = +1.71V$ to $+3.465V$, $T_A = -40^{\circ}C$ to $+85^{\circ}C$, unless otherwise noted. Typical values are at $V_{DD} = V_{DDO} = +2.5V$, $T_A = +25^{\circ}C$.) (Notes 1, 2)

PARAMETER	SYMBOL	CONDITIONS	MIN	TYP	MAX	UNITS
SINGLE-ENDED OUTPUTS (PCLKOUT, DOUT_)						
High-Level Output Voltage	V_{OH}	$V_{DDO} = +2.375V$ to $+3.465V$, $I_{OH} = -1mA$	0.8 x V_{DDO}			V
Low-Level Output Voltage	V_{OL}	$V_{DDO} = +2.375V$ to $+3.465V$, $I_{OL} = 1mA$			0.2	V
Output Short-Circuit Current	I_{OS}	Output shorted to ground	$V_{DDO} = 2.375V$	-2		mA
			$V_{DDO} = 3.135V$	-9		
			$V_{DDO} = 3.465V$	-25		
LCDS INPUT (SDI+, SDI-)						
Differential Input-Current Threshold	I_{ID}			400		μA
Common-Mode Input Current	I_{IC}		-300	± 500	+300	μA
Differential Input Impedance	Z_{ID}	$I_{IC} = 0\mu A$ at $V_{DD} = 3.3V \pm 5\%$	69	90	109	Ω
		$I_{IC} = 0\mu A$ at $V_{DD} = 2.8V \pm 5\%$	82	108	132	
		$I_{IC} = 0\mu A$ at $V_{DD} = 2.5V \pm 5\%$	95	125	153	
		$I_{IC} = \pm 300\mu A$ at $V_{DD} = 3.3V \pm 5\%$	67	91	112	
		$I_{IC} = \pm 300\mu A$ at $V_{DD} = 2.8V \pm 5\%$	86	108	136	
Common-Mode Input Impedance	Z_{IC}	$I_{IC} = \pm 300\mu A$	90	167	375	Ω
Input Capacitance	C_{IN}	SDI+ or SDI- to ground		2		pF
POWER SUPPLY						
Supply Current (Note 4)	I_{TOT}	$V_{DD} = V_{DDO} = 2.5V$ DOUT_ = all high or all low	PCLKOUT = 5MHz (110Mbps)	9	12	mA
			PCLKOUT = 10MHz (220Mbps)	9	12	
Worst-Case Pattern Supply Current (Note 4)	I_{TOTW}	$C_L = 5pF$, $V_{DD} = V_{DDO} = 2.5V$, Figure 2	PCLKOUT = 5MHz (110Mbps)	10	12	mA
			PCLKOUT = 10MHz (220Mbps)	10	12	
Power-Down Supply Current (Note 4)	I_{TOTZ}			0.08	3	μA
Supply Difference	V_{SD}	MAX9223 V_{DD} to MAX9224 V_{DD}	-5		+5	%
GROUND POTENTIAL						
Ground Difference	V_{GD}	MAX9223 to MAX9224 ground difference	-0.2		+0.2	V

22-Bit, Low-Power, 5MHz to 10MHz Serializer and Deserializer Chipset

AC ELECTRICAL CHARACTERISTICS—MAX9223

($V_{DD} = +2.375V$ to $+3.465V$, $T_A = -40^{\circ}C$ to $+85^{\circ}C$, unless otherwise noted. Typical values are at $V_{DD} = +2.5V$, $T_A = +25^{\circ}C$.) (Note 3)

PARAMETER	SYMBOL	CONDITIONS	MIN	TYP	MAX	UNITS
PCLKIN INPUT REQUIREMENTS (Figure 3)						
Input Rise Time	t_R				2	ns
Input Fall Time	t_F				2	ns
PCLKIN Period	t_P		100		200	ns
High-Level Pulse Width	t_{PWH}		$0.3 \times t_P$		$0.7 \times t_P$	ns
Low-Level Pulse Width	t_{PWL}		$0.3 \times t_P$		$0.7 \times t_P$	ns
Setup Time	t_S		3			ns
Hold Time	t_H		1			ns

AC ELECTRICAL CHARACTERISTICS—MAX9224

($V_{DD} = V_{DDO} = +2.375V$ to $+3.465V$, $C_L = 5pF$, $T_A = -40^{\circ}C$ to $+85^{\circ}C$, unless otherwise noted. Typical values are at $V_{DD} = V_{DDO} = +2.5V$, $T_A = +25^{\circ}C$.) (Notes 3, 5)

PARAMETER	SYMBOL	CONDITIONS	MIN	TYP	MAX	UNITS
PCLKOUT Period	t_P	Figure 4	100		200	ns
High-Level Pulse Width	t_{PWH}	Figure 4	$0.4 \times t_P$		$0.6 \times t_P$	ns
Low-Level Pulse Width	t_{PWL}	Figure 4	$0.4 \times t_P$		$0.6 \times t_P$	ns
Data Valid Before PCLKOUT	t_{VB}	Figure 4	5			ns
Data Valid After PCLKOUT	t_{VA}	Figure 4	5			ns
SERIALIZER AND DESERIALIZER LINK						
Power-Up Time	t_{PU1}	From $V_{DD} = V_{DDO} = 2.375V$ when supplies are ramping up			$6144 \times t_P$	ns
	t_{PU2}	From \overline{PWRDN} low to high			$4096 \times t_P$	
Power-Down Time	t_{PWRDN}	From \overline{PWRDN} high to low		2.8	10	μs

Note 1: Current into a pin is defined as positive. Current out of a pin is defined as negative. All voltages are referenced to ground.

Note 2: Maximum and minimum limits over temperature are guaranteed by design and characterization. Devices are production tested at $T_A = +85^{\circ}C$.

Note 3: Parameters are guaranteed by design and characterization, and are not production tested. Limits are set at ± 6 sigma.

Note 4: $I_{TOT} = I_{DD} + I_{DDO}$.

Note 5: C_L includes probe and test jig capacitance.

22-Bit, Low-Power, 5MHz to 10MHz Serializer and Deserializer Chipset

Test Circuits/Timing Diagrams

MAX9223/MAX9224

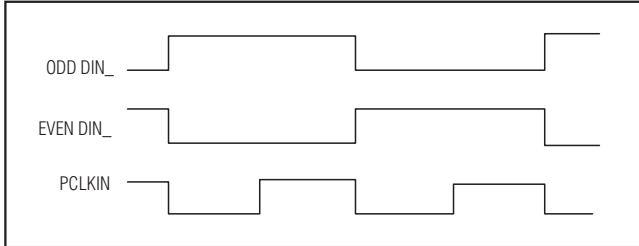

Figure 1. Serializer Worst-Case Switching Pattern

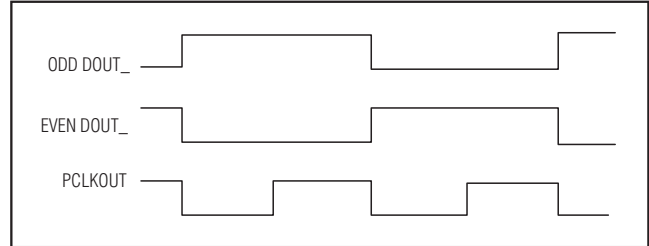

Figure 2. Deserializer Worst-Case Switching Pattern

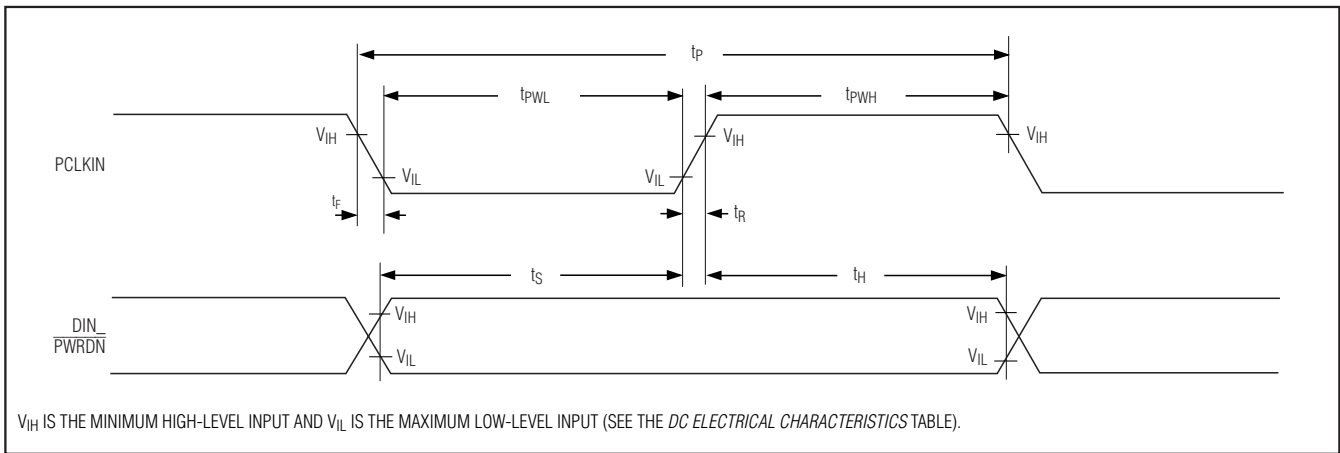

Figure 3. Serializer Input Timing

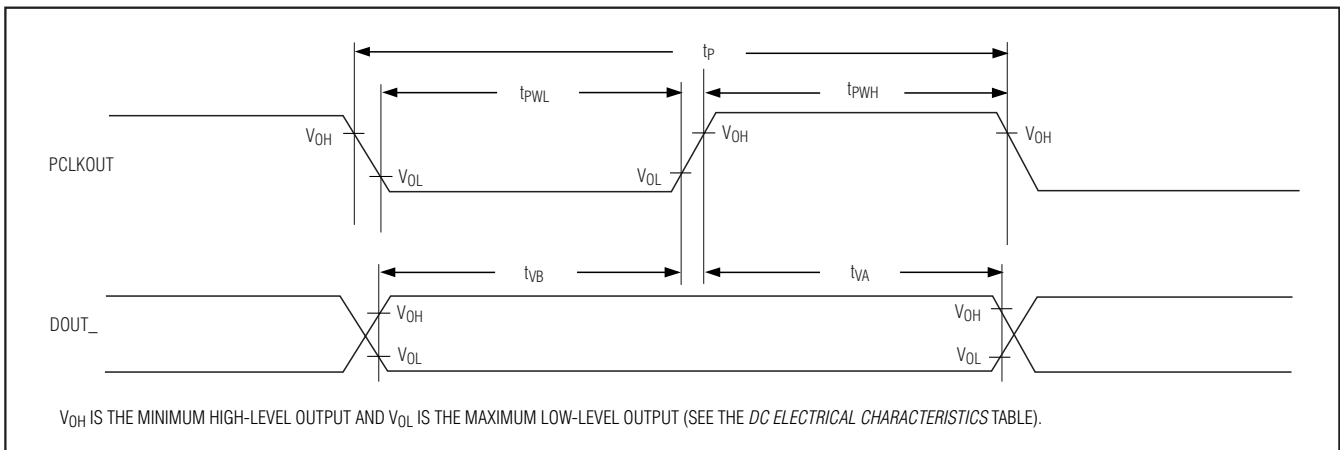
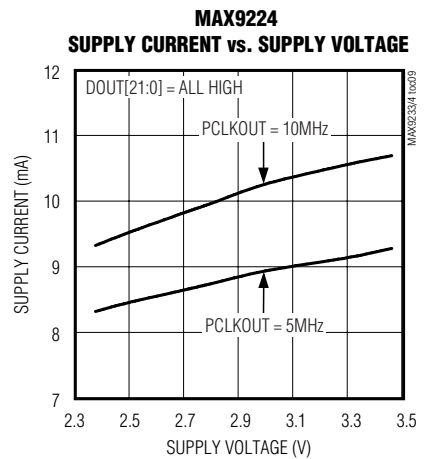
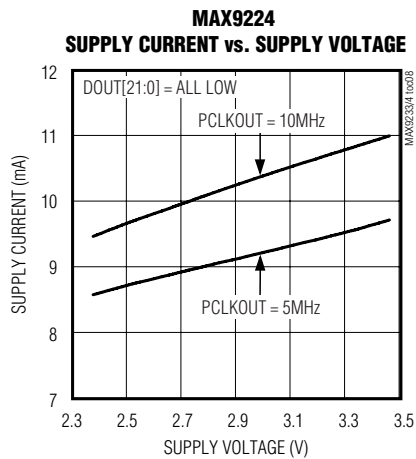
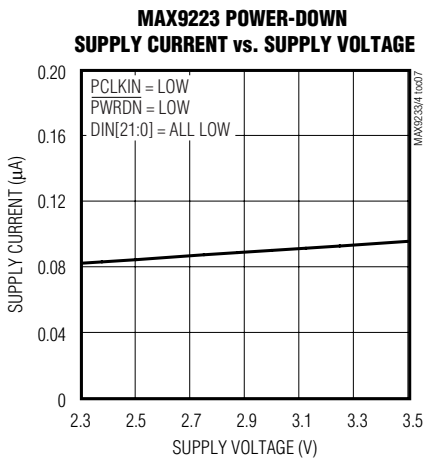
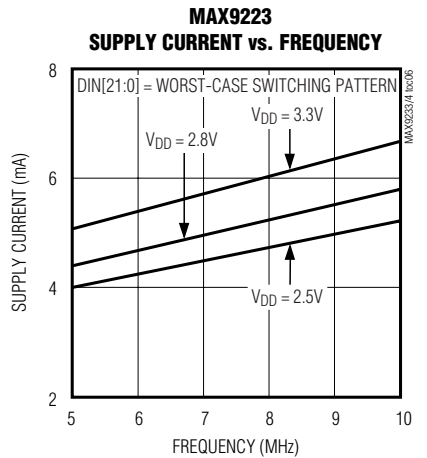
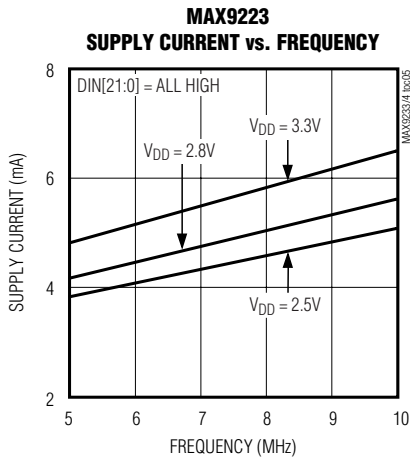
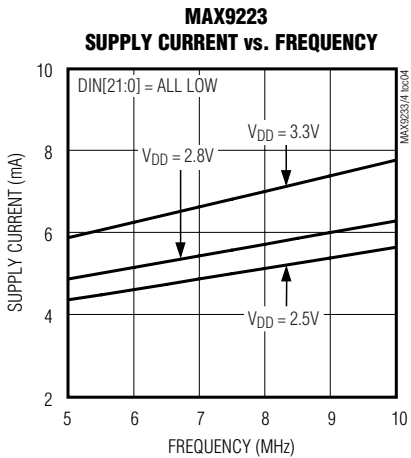
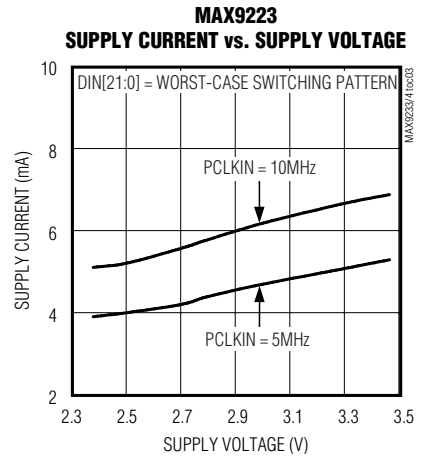
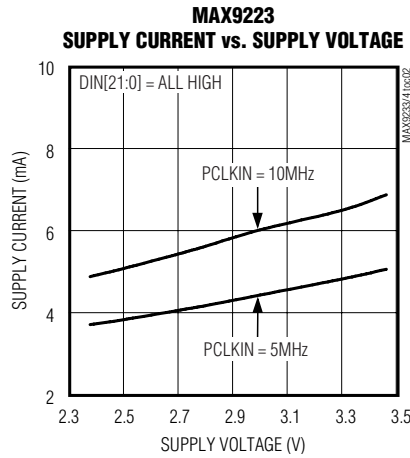
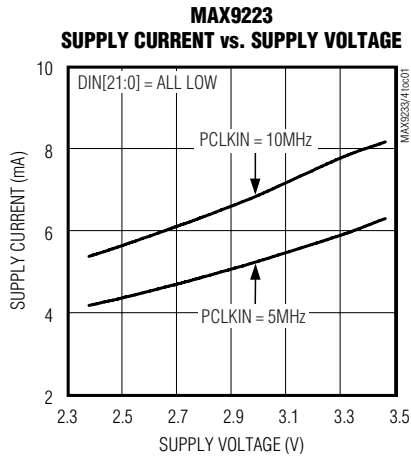

Figure 4. Deserializer Output Timing

22-Bit, Low-Power, 5MHz to 10MHz Serializer and Deserializer Chipset

Typical Operating Characteristics

($V_{DD} = V_{DDO} = +2.8V$, logic input levels = 0 to +2.8V, logic output load $C_L = 5pF$, $T_A = +25^\circ C$, unless otherwise noted.)



22-Bit, Low-Power, 5MHz to 10MHz Serializer and Deserializer Chipset

MAX9223/MAX9224

Typical Operating Characteristics (continued)

($V_{DD} = V_{DDO} = +2.8V$, logic input levels = 0 to +2.8V, logic output load $C_L = 5pF$, $T_A = +25^\circ C$, unless otherwise noted.)

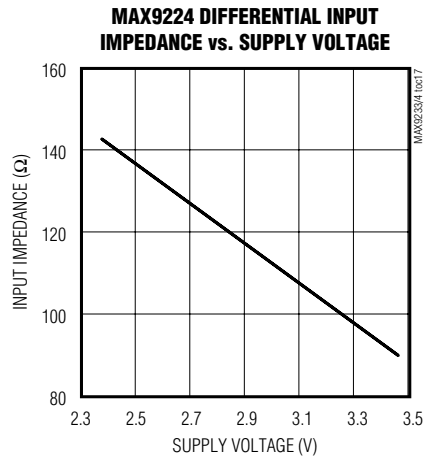
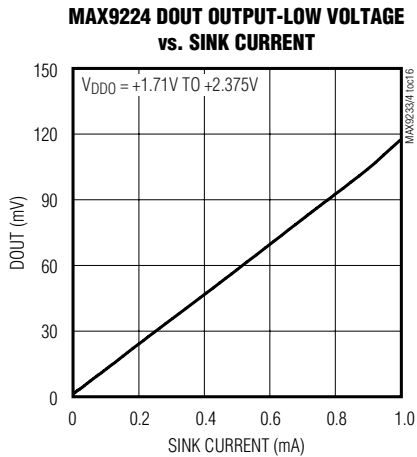
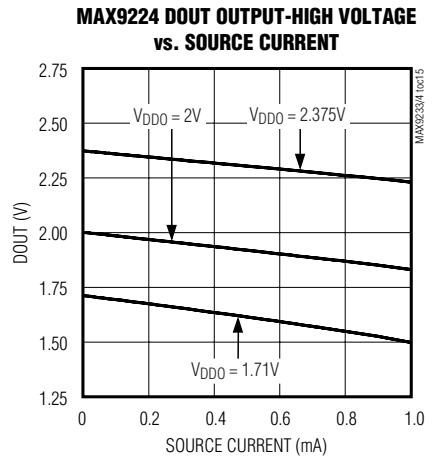
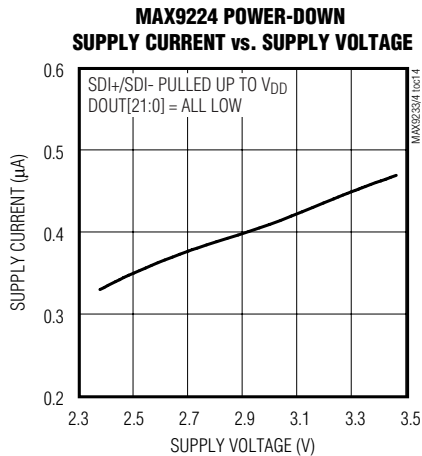
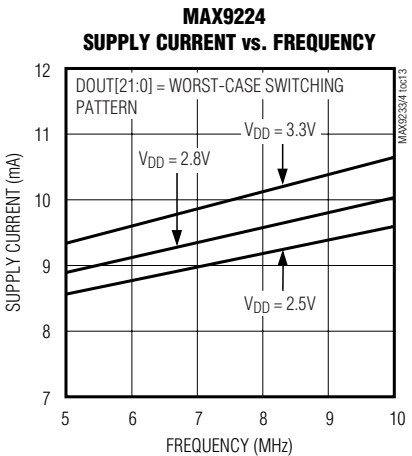
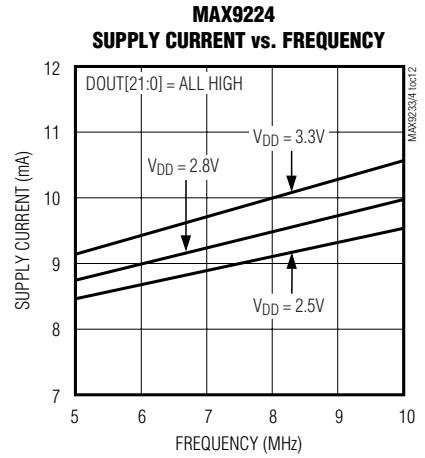
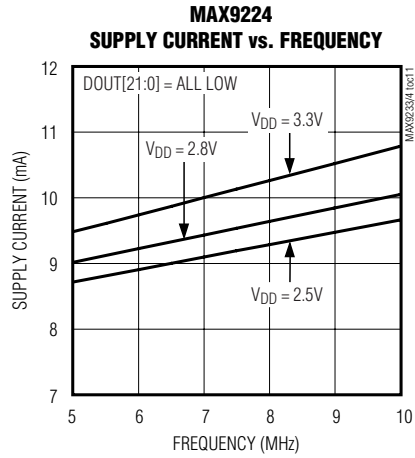
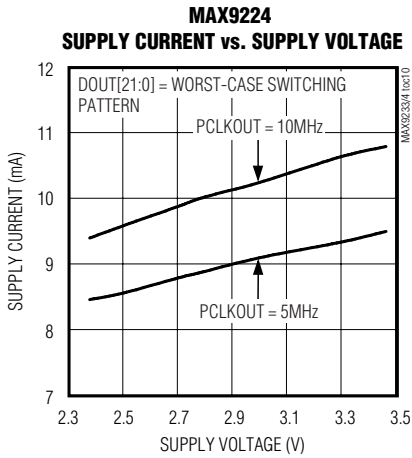

22-Bit, Low-Power, 5MHz to 10MHz Serializer and Deserializer Chipset

Pin Description (MAX9223)

PIN	NAME	FUNCTION
1–12, 14, 15, 21–28	DIN13–DIN2, DIN1, DIN0, DIN21–DIN14	Single-Ended Parallel Data Inputs. The 22 data bits are loaded into the input latch on the rising edge of PCLKIN. DIN[21:0] are 1.71V to 3.465V tolerant. Internally pulled down to GND.
13	PCLKIN	Parallel Clock Input. The rising edge of PCLKIN (typically the pixel clock) latches the parallel data input. Internally pulled down to GND.
16	$\overline{\text{PWRDN}}$	Power-Down Input. Pull $\overline{\text{PWRDN}}$ low to place the MAX9223 and MAX9224 in power-down mode. Drive $\overline{\text{PWRDN}}$ high for normal operation. Internally pulled down to GND.
17	SDO-	Inverting LCDS Serial-Data Output
18	SDO+	Noninverting LCDS Serial-Data Output
19	GND	Ground
20	V _{DD}	Core Supply Voltage. Bypass to GND with 0.1 μ F and 0.01 μ F capacitors in parallel as close to the device as possible, with the smallest value capacitor closest to the supply pin.
—	EP	Exposed Paddle. Connect EP to ground.

Pin Description (MAX9224)

PIN	NAME	FUNCTION
1, 7, 8, 10–28	DOUT21, DOUT0, DOUT1, DOUT2–DOUT20	Single-Ended Parallel Data Outputs. DOUT[21:0] are valid on the rising edge of PCLKOUT.
2	V _{DDO}	Output Supply Voltage. Bypass to GND with 0.1 μ F and 0.01 μ F capacitors in parallel as close to the device as possible, with the smallest value capacitor closest to the supply pin.
3	GND	Ground
4	SDI+	Noninverting LCDS Serial-Data Input
5	SDI-	Inverting LCDS Serial-Data Input
6	V _{DD}	Core Supply Voltage. Bypass to GND with 0.1 μ F and 0.01 μ F capacitors in parallel as close to the device as possible, with the smallest value capacitor closest to the supply pin.
9	PCLKOUT	Parallel Clock Output. Parallel output data are valid on the rising edge of PCLKOUT (typically the pixel clock).
—	EP	Exposed Paddle. Connect EP to ground.

22-Bit, Low-Power, 5MHz to 10MHz Serializer and Deserializer Chipset

MAX9223/MAX9224

MAX9223 Functional Diagram

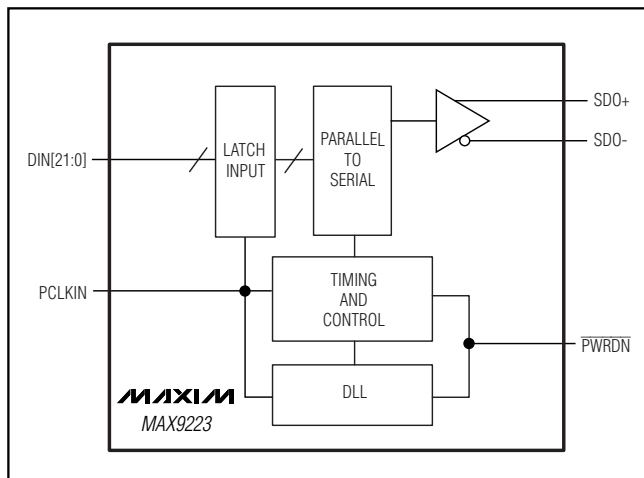

MAX9224 Functional Diagram

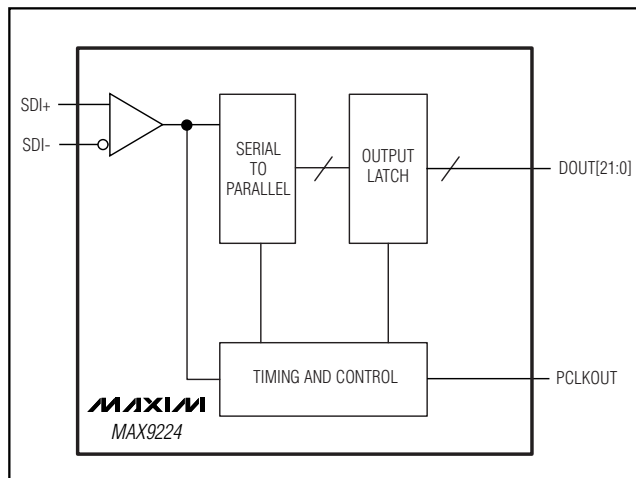

Detailed Description

The MAX9223 serializer operates at a 5MHz to 10MHz parallel clock frequency, serializing 22 bits of parallel input data DIN[21:0] in each cycle of the parallel clock. DIN[21:0] are latched on the rising edge of PCLKIN. The data and internally generated serial clock are combined and transmitted through SDO+/SDO- using multilevel LCDS. The MAX9224 deserializer receives the LCDS signal on SDI+/SDI-. The deserialized data and recovered parallel clock are available at DOUT[21:0]

and PCLKOUT. Output data is valid on the rising edge of PCLKOUT.

The first bit (G) is internally grounded and transmitted first. Bit 0 (DIN[0]) is the first valid data bit. Boundary bits OH are used by the MAX9224 deserializer to identify the word boundary and are the inverse polarity of data bit 21 (DIN[21]). Therefore, at least one level transition is guaranteed in one word. The clock is recovered from the serial input.

Serial word format:

G	0	1	2	3	4	5	6	7	8	9	10	11	12	13	14	15	16	17	18	19	20	21	OH	OH
---	---	---	---	---	---	---	---	---	---	---	----	----	----	----	----	----	----	----	----	----	----	----	----	----

LCDS

The MAX9223/MAX9224 use a proprietary multilevel LCDS interface. Figure 5 provides a representation of the data and clock in the multilevel LCDS interface. This interface offers advantages over other chipsets, such as requiring only one differential pair as the transmission medium, the inherently aligned data and clock, and much smaller current levels than the 4mA typically found in traditional LVDS interfaces.

MAX9223/MAX9224 Handshaking

The handshaking function of the MAX9223/MAX9224 provides bidirectional communication between the two devices in case a word boundary error is detected. Prior

to data transmission, the MAX9223 serializer adds boundary bits (OH) to the end of the latched word. These boundary bits are the inverse of the last bit of the latched word. During data transmission, the MAX9224 deserializer continuously monitors the state of the boundary bits of each word. If a word boundary error is detected, the serial link is pulled up to V_{DD} and the MAX9224 powers down. The MAX9223 detects the pullup of the serial link and powers down for 1.0µs. After 1.0µs, the MAX9223 powers up, causing the power-up of the MAX9224. Then the word boundary is reestablished, and data transfer resumes. The handshaking function is disabled when PWRDN is pulled low.

22-Bit, Low-Power, 5MHz to 10MHz Serializer and Deserializer Chipset

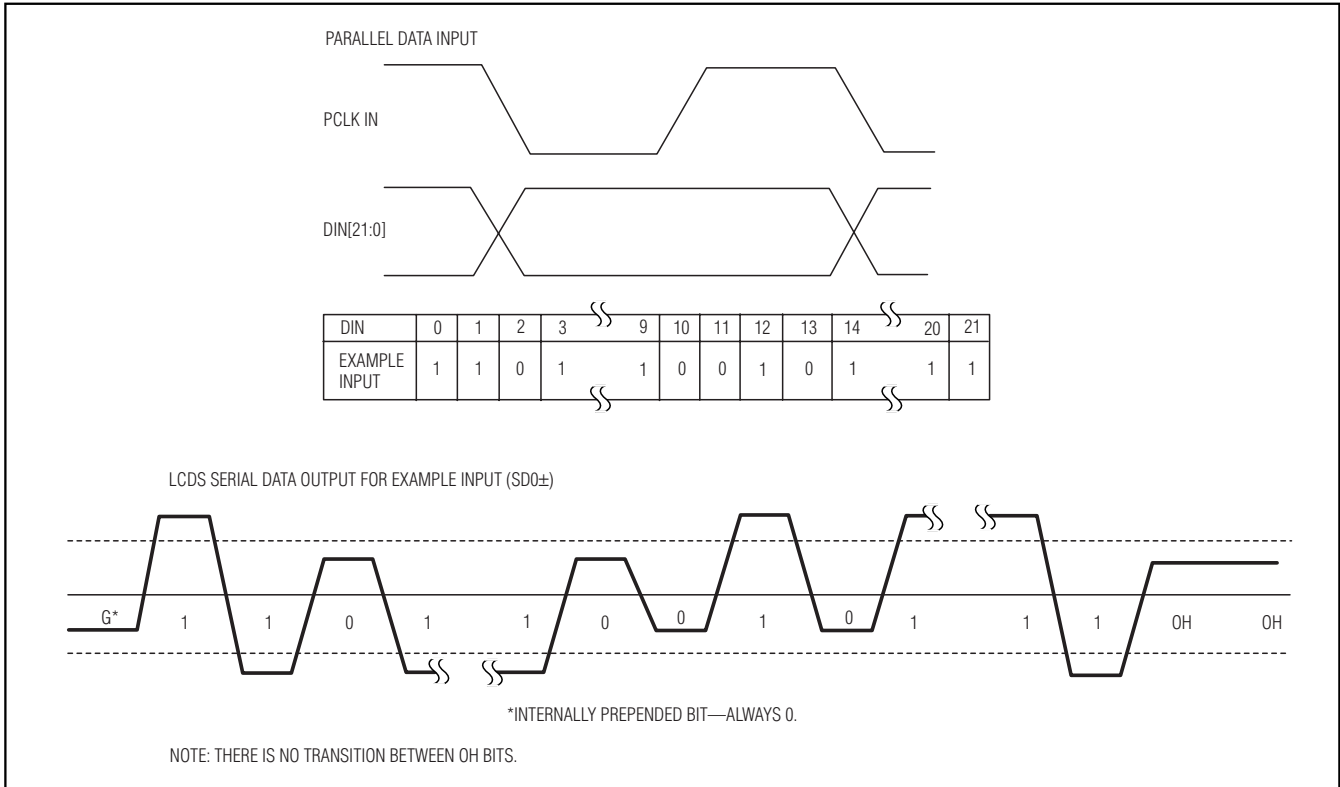

Figure 5. Multilevel LCDS Output Representation

Applications Information

PCLKIN Latch Edge

The parallel data input of the MAX9223 serializer is latched on the rising edge of PCLKIN. Figure 3 shows the serializer input timing.

PCLKOUT Strobe

The serial-data output of the MAX9224 deserializer is valid on the rising edge of PCLKOUT. Figure 4 shows the deserializer output timing.

Power-Down and Power-Up

Driving $\overline{\text{PWRDN}}$ low puts the MAX9223 in power-down mode and sends a pulse to power down the MAX9224. In power-down mode, the DLL is stopped, SDO+/SDO- are high impedance to ground and differential, and the LCDS link is weakly biased around $V_{DD} - 0.8V$. With $\overline{\text{PWRDN}}$ and all inputs low, the combined MAX9223/MAX9224 supply current is reduced to 3.5µA or less.

Driving $\overline{\text{PWRDN}}$ high starts DLL lock to PCLKIN and initiates a MAX9224 power-up sequence. The MAX9223

LCDS output is not driven until the DLL locks. 4096 clock cycles are required for the power-up and link synchronization, before valid DIN can be latched. See Figure 6 for an overall power-up and power-down timing diagram. For normal operation, PCLKIN must be running and settled before driving $\overline{\text{PWRDN}}$ high.

If $V_{DD} = 0$, the LCDS outputs are high impedance to ground and differential.

Ground-Shift Tolerance

The MAX9223/MAX9224 are designed to function normally in the event of a slight shift in ground potential. However, the MAX9224 deserializer ground must be within ±0.2V relative to the MAX9223 serializer ground to maintain proper operation.

MAX9224 Output Buffer Supply (VDDO)

The MAX9224 parallel outputs are powered from VDDO, which accepts a +1.71V to +3.465V supply, allowing direct interface to inputs with 1.8V to 3.3V logic levels.

22-Bit, Low-Power, 5MHz to 10MHz Serializer and Deserializer Chipset

MAX9223/MAX9224

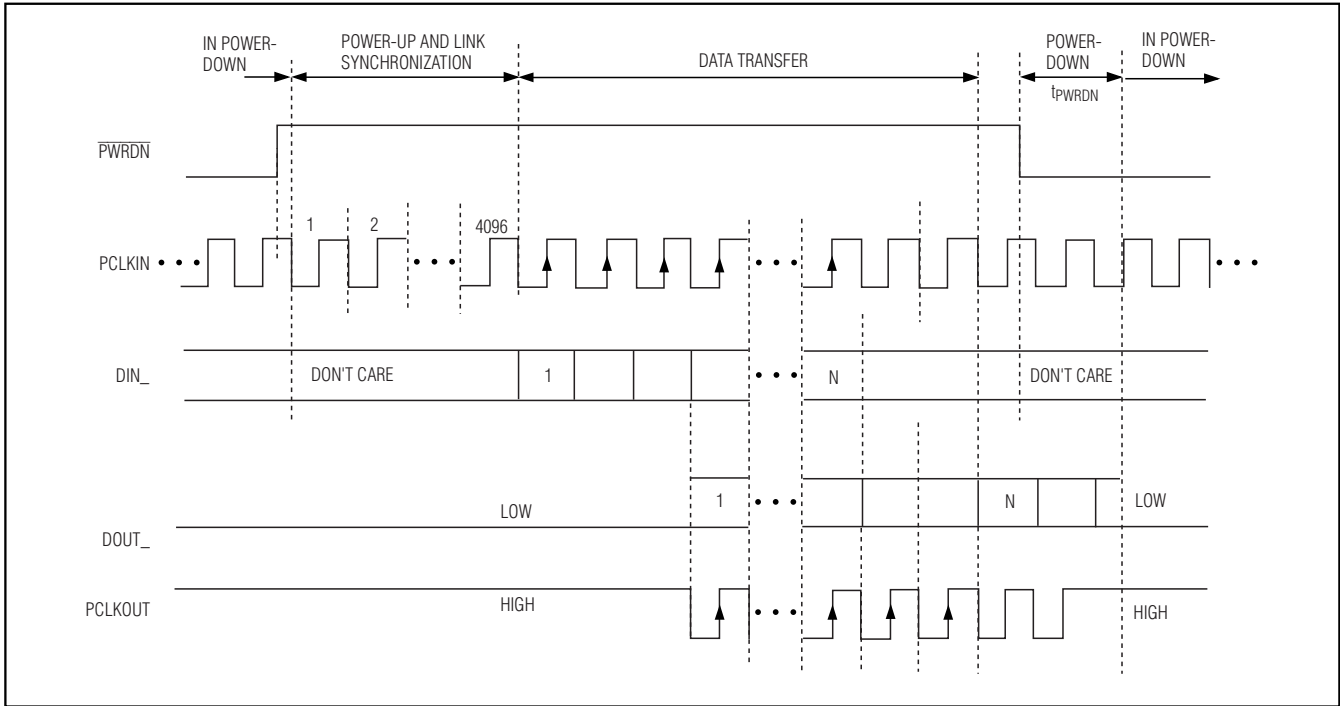

Figure 6. MAX9223/MAX9224 Power-Up/Power-Down Sequence

Flex Cable, PCB Interconnect, and Connectors

Interconnect for LCDS typically has a differential impedance of 110Ω . Use interconnect and connectors that have matched differential impedance to minimize impedance discontinuities.

Board Layout and Supply Bypassing

Separate the logic and LCDS signals to prevent crosstalk. A PCB or flex with separate layers for power, ground, and signals is recommended.

Bypass each V_{DD} and V_{DDO} pin with high-frequency, surface-mount ceramic $0.1\mu\text{F}$ and $0.01\mu\text{F}$ capacitors in parallel as close to the device as possible, with the smallest value capacitor closest to the supply pin.

ESD Protection

The MAX9223/MAX9224 LCDS inputs and outputs (SDO+/SDO-, SDI+/SDI-) are rated for $\pm 15\text{kV}$ ESD protection using the Human Body Model. The Human Body Model discharge components are $C_S = 100\text{pF}$ and $R_D = 1.5\text{k}\Omega$ (Figure 7).

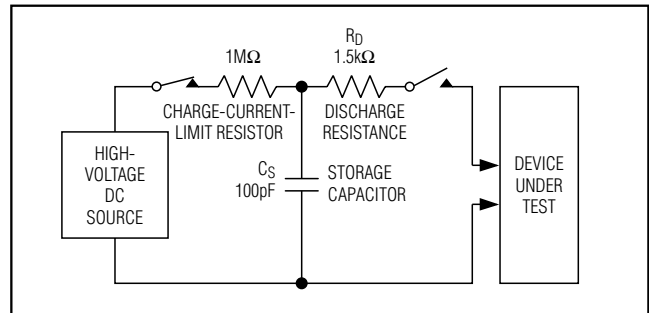

Figure 7. Human Body Model ESD Test Circuit

Chip Information

PROCESS: CMOS

22-Bit, Low-Power, 5MHz to 10MHz Serializer and Deserializer Chipset

Pin Configurations

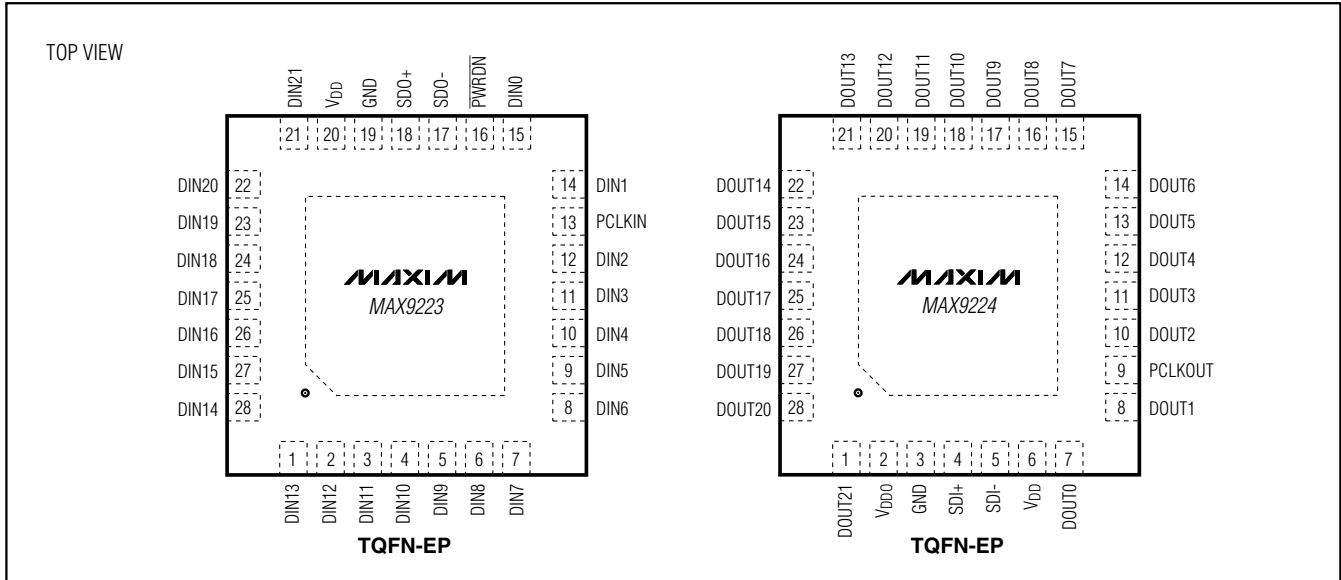

22-Bit, Low-Power, 5MHz to 10MHz Serializer and Deserializer Chipset

Package Information

(The package drawing(s) in this data sheet may not reflect the most current specifications. For the latest package outline information, go to www.maxim-ic.com/packages.)

MAX9223/MAX9224

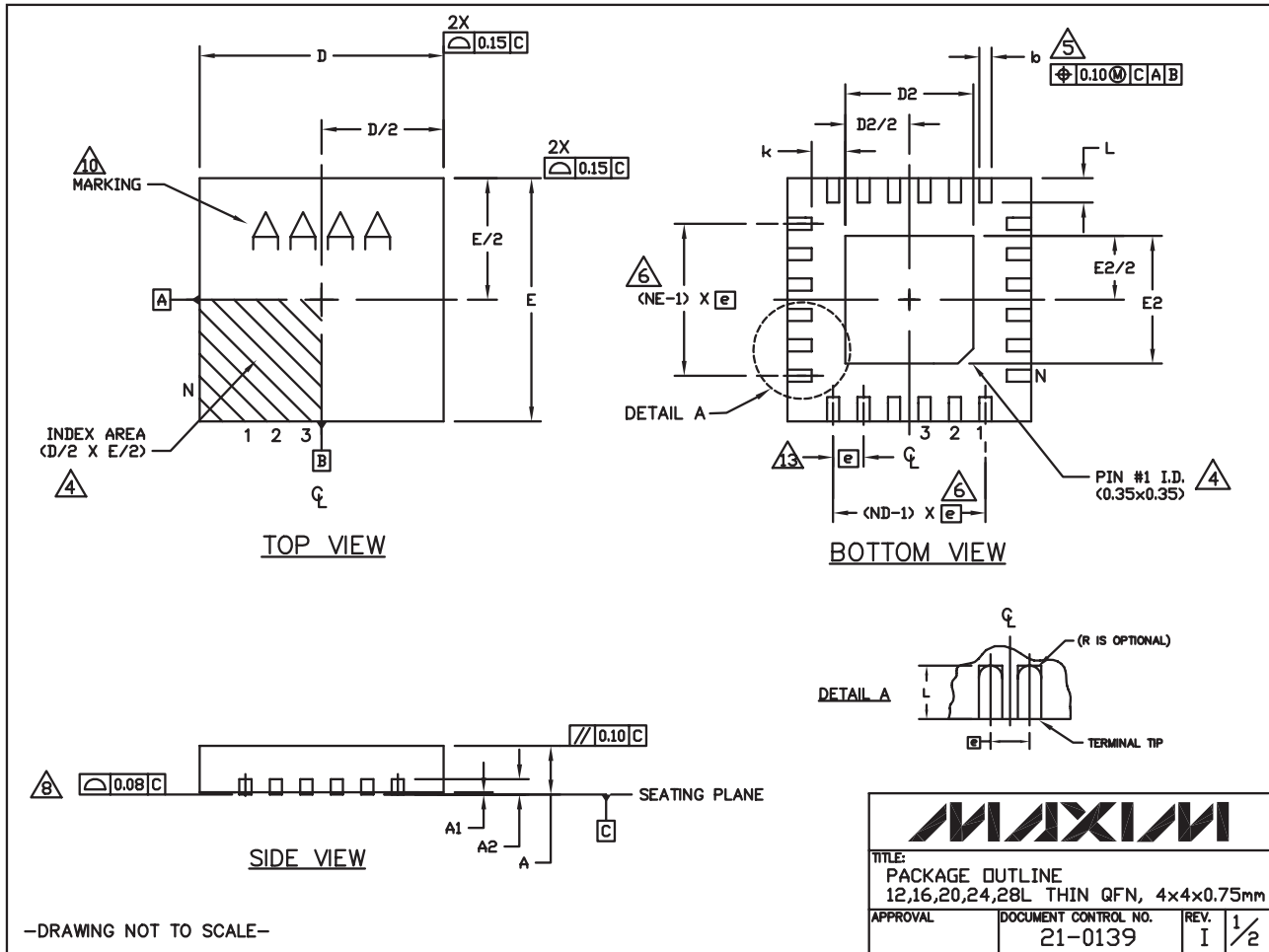

22-Bit, Low-Power, 5MHz to 10MHz Serializer and Deserializer Chipset

Package Information (continued)

(The package drawing(s) in this data sheet may not reflect the most current specifications. For the latest package outline information go to www.maxim-ic.com/packages.)

COMMON DIMENSIONS															
PKG	12L 4x4			16L 4x4			20L 4x4			24L 4x4			28L 4x4		
REF.	MIN.	NOM.	MAX.	MIN.	NOM.	MAX.	MIN.	NOM.	MAX.	MIN.	NOM.	MAX.	MIN.	NOM.	MAX.
A	0.70	0.75	0.80	0.70	0.75	0.80	0.70	0.75	0.80	0.70	0.75	0.80	0.70	0.75	0.80
A1	0.0	0.02	0.05	0.0	0.02	0.05	0.0	0.02	0.05	0.0	0.02	0.05	0.0	0.02	0.05
A2	0.20 REF.			0.20 REF.			0.20 REF.			0.20 REF.			0.20 REF.		
b	0.25	0.30	0.35	0.25	0.30	0.35	0.20	0.25	0.30	0.18	0.23	0.30	0.15	0.20	0.25
D	3.90	4.00	4.10	3.90	4.00	4.10	3.90	4.00	4.10	3.90	4.00	4.10	3.90	4.00	4.10
E	3.90	4.00	4.10	3.90	4.00	4.10	3.90	4.00	4.10	3.90	4.00	4.10	3.90	4.00	4.10
e	0.80 BSC.			0.65 BSC.			0.50 BSC.			0.50 BSC.			0.40 BSC.		
k	0.25	-	-	0.25	-	-	0.25	-	-	0.25	-	-	0.25	-	-
L	0.45	0.55	0.65	0.45	0.55	0.65	0.45	0.55	0.65	0.30	0.40	0.50	0.30	0.40	0.50
N	12			16			20			24			28		
ND	3			4			5			6			7		
NE	3			4			5			6			7		
JeDEC Var.	WGGB			WGGC			WGGD-1			WGGD-2			WGGE		

EXPOSED PAD VARIATIONS						
PKG. CODES	D2			E2		
	MIN.	NOM.	MAX.	MIN.	NOM.	MAX.
T1244-3	1.95	2.10	2.25	1.95	2.10	2.25
T1244-4	1.95	2.10	2.25	1.95	2.10	2.25
T1644-3	1.95	2.10	2.25	1.95	2.10	2.25
T1644-4	1.95	2.10	2.25	1.95	2.10	2.25
T2044-2	1.95	2.10	2.25	1.95	2.10	2.25
T2044-3	1.95	2.10	2.25	1.95	2.10	2.25
T2444-2	1.95	2.10	2.25	1.95	2.10	2.25
T2444-3	2.45	2.60	2.63	2.45	2.60	2.63
T2444-4	2.45	2.60	2.63	2.45	2.60	2.63
T2444N-4	2.45	2.60	2.63	2.45	2.60	2.63
T2444M-1	2.45	2.60	2.63	2.45	2.60	2.63
T2844-1	2.50	2.60	2.70	2.50	2.60	2.70

NOTES:

- DIMENSIONING & TOLERANCING CONFORM TO ASME Y14.5M-1994.
- ALL DIMENSIONS ARE IN MILLIMETERS. ANGLES ARE IN DEGREES.
- N IS THE TOTAL NUMBER OF TERMINALS.
- THE TERMINAL #1 IDENTIFIER AND TERMINAL NUMBERING CONVENTION SHALL CONFORM TO JESD 95-1 SPP-012. DETAILS OF TERMINAL #1 IDENTIFIER ARE OPTIONAL, BUT MUST BE LOCATED WITHIN THE ZONE INDICATED. THE TERMINAL #1 IDENTIFIER MAY BE EITHER A MOLD OR MARKED FEATURE.
- DIMENSION b APPLIES TO METALLIZED TERMINAL AND IS MEASURED BETWEEN 0.25mm AND 0.30mm FROM TERMINAL TIP.
- ND AND NE REFER TO THE NUMBER OF TERMINALS ON EACH D AND E SIDE RESPECTIVELY.
- DEPOPULATION IS POSSIBLE IN A SYMMETRICAL FASHION.
- COPLANARITY APPLIES TO THE EXPOSED HEAT SINK SLUG AS WELL AS THE TERMINALS.
- DRAWING CONFORMS TO JEDEC M0220, EXCEPT FOR T2444-3, T2444-4 AND T2844-1.
- MARKING IS FOR PACKAGE ORIENTATION REFERENCE ONLY.
- COPLANARITY SHALL NOT EXCEED 0.08mm.
- WARPAGE SHALL NOT EXCEED 0.10mm.
- LEAD CENTERLINES TO BE AT TRUE POSITION AS DEFINED BY BASIC DIMENSION 'e', ±0.05.
- NUMBER OF LEADS SHOWN ARE FOR REFERENCE ONLY.
- ALL DIMENSIONS ARE THE SAME FOR LEADED (-) & PbfFREE (+) PACKAGE CODES.

-DRAWING NOT TO SCALE-

TITLE: PACKAGE OUTLINE 12,16,20,24,28L THIN QFN, 4x4x0.75mm		
APPROVAL	DOCUMENT CONTROL NO. 21-0139	REV. I 2/2

22-Bit, Low-Power, 5MHz to 10MHz Serializer and Deserializer Chipset

Revision History

REVISION NUMBER	REVISION DATE	DESCRIPTION	PAGES CHANGED
0	10/05	Initial release	—
1	12/07	Changed min output short-circuit current from -20 to -25 and updated package outlines.	3, 13

MAX9223/MAX9224

Maxim cannot assume responsibility for use of any circuitry other than circuitry entirely embodied in a Maxim product. No circuit patent licenses are implied. Maxim reserves the right to change the circuitry and specifications without notice at any time.

Maxim Integrated Products, 120 San Gabriel Drive, Sunnyvale, CA 94086 408-737-7600 _____ 15