

74LVT2240 • 74LVTH2240

Low Voltage Inverting Octal Buffer/Line Driver with 3-STATE Outputs and 25Ω Series Resistors in the Outputs

General Description

The LVT2240 and LVTH2240 are inverting octal buffers and line drivers designed to be employed as memory address drivers, clock drivers and bus oriented transmitters or receivers which provides improved PC board density. The equivalent 25Ω Series resistors helps reduce output overshoot and undershoot.

The LVTH2240 data inputs include bushold, eliminating the need for external pull-up resistors to hold unused inputs.

These inverting octal buffers and line drivers are designed for low-voltage (3.3V) V_{CC} applications, but with the capability to provide a TTL interface to a 5V environment. The LVT2240 and LVTH2240 are fabricated with an advanced BiCMOS technology to achieve high speed operation similar to 5V ABT while maintaining low power dissipation.

Features

- Input and output interface capability to systems at 5V V_{CC}
- Equivalent 25Ω Series resistors on outputs
- Bushold data inputs eliminate the need for external pull-up resistors to hold unused inputs (74LVTH2240), also available without bushold feature (74LVT2240)
- Live insertion/extraction permitted
- Power Up/Down high impedance provides glitch-free bus loading
- Outputs source/sink -12 mA/+12 mA
- Latch-up performance exceeds 500 mA
- ESD performance:
 - Human-body model > 2000V
 - Machine model > 200V
 - Charged-device model > 1000V

Ordering Code:

Order Number	Package Number	Package Description
74LVT2240WM	M20B	20-Lead Small Outline Integrated Circuit (SOIC), JEDEC MS-013, 0.300" Wide
74LVT2240SJ	M20D	Pb-Free 20-Lead Small Outline Package (SOP), EIAJ TYPE II, 5.3mm Wide
74LVT2240MTC	MTC20	20-Lead Thin Shrink Small Outline Package (TSSOP), JEDEC MO-153, 4.4mm Wide
74LVTH2240WM	M20B	20-Lead Small Outline Integrated Circuit (SOIC), JEDEC MS-013, 0.300" Wide
74LVTH2240SJ	M20D	Pb-Free 20-Lead Small Outline Package (SOP), EIAJ TYPE II, 5.3mm Wide
74LVTH2240MTCX (Note 1)	MTC20	20-Lead Thin Shrink Small Outline Package (TSSOP), JEDEC MO-153, 4.4mm Wide

Devices also available in Tape and Reel. Specify by appending suffix letter "X" to the ordering code.
Pb-Free package per JEDEC J-STD-020B.

Note 1: Available only in Tape and Reel.

74LVT2240 • 74LVTH2240 Low Voltage Inverting Octal Buffer/Line Driver with 3-STATE Outputs and 25Ω Series Resistors in the Outputs

Logic Symbol

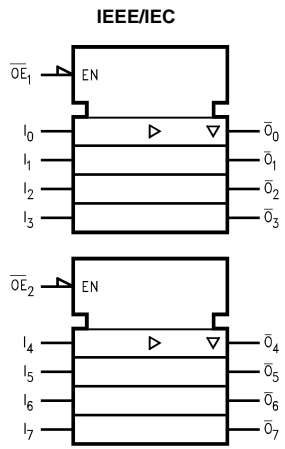

Connection Diagram

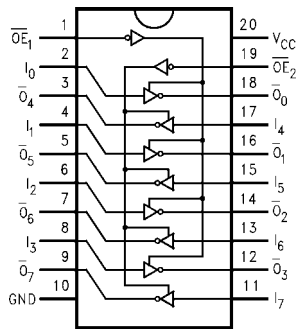

Pin Descriptions

Pin Names	Description
$\overline{OE}_1, \overline{OE}_2$	3-STATE Output Enable Inputs
I_0-I_7	Inputs
$\overline{O}_0-\overline{O}_7$	Outputs

Truth Tables

Inputs		Outputs (Pins 12, 14, 16, 18)
\overline{OE}_1	I_n	
L	L	H
L	H	L
H	X	Z

Inputs		Outputs (Pins 3, 5, 7, 9)
\overline{OE}_2	I_n	
L	L	H
L	H	L
H	X	Z

H = HIGH Voltage Level
 L = LOW Voltage Level
 X = Immaterial
 Z = High Impedance

Absolute Maximum Ratings ^(Note 2)					
Symbol	Parameter	Value	Conditions		Units
V_{CC}	Supply Voltage	-0.5 to +4.6			V
V_I	DC Input Voltage	-0.5 to +7.0			V
V_O	DC Output Voltage	-0.5 to +7.0	Output in 3-STATE		V
		-0.5 to +7.0	Output in HIGH or LOW State (Note 3)		V
I_{IK}	DC Input Diode Current	-50	$V_I < GND$		mA
I_{OK}	DC Output Diode Current	-50	$V_O < GND$		mA
I_O	DC Output Current	64	$V_O > V_{CC}$ Output at HIGH State		mA
		128	$V_O > V_{CC}$ Output at LOW State		
I_{CC}	DC Supply Current per Supply Pin	±64			mA
I_{GND}	DC Ground Current per Ground Pin	±128			mA
T_{STG}	Storage Temperature	-65 to +150			°C

Recommended Operating Conditions					
Symbol	Parameter	Min	Max	Units	
V_{CC}	Supply Voltage	2.7	3.6	V	
V_I	Input Voltage	0	5.5	V	
I_{OH}	HIGH-Level Output Current		-12	mA	
I_{OL}	LOW-Level Output Current		12		
T_A	Free-Air Operating Temperature	-40	85	°C	
$\Delta t/\Delta V$	Input Edge Rate, $V_{IN} = 0.8V-2.0V$, $V_{CC} = 3.0V$	0	10	ns/V	

Note 2: Absolute Maximum continuous ratings are those values beyond which damage to the device may occur. Exposure to these conditions or conditions beyond those indicated may adversely affect device reliability. Functional operation under absolute maximum rated conditions is not implied.

Note 3: I_O Absolute Maximum Rating must be observed.

DC Electrical Characteristics

Symbol	Parameter	V_{CC} (V)	$T_A = -40^\circ C$ to $+85^\circ C$			Units	Conditions	
			Min	Typ (Note 4)	Max			
V_{IK}	Input Clamp Diode Voltage	2.7			-1.2	V	$I_I = -18$ mA	
V_{IH}	Input HIGH Voltage	2.7-3.6	2.0			V	$V_O \leq 0.1V$ or $V_O \geq V_{CC} - 0.1V$	
V_{IL}	Input LOW Voltage	2.7-3.6			0.8			
V_{OH}	Output HIGH Voltage	2.7-3.6	$V_{CC} - 0.2$			V	$I_{OH} = -100$ μA	
		3.0	2.0			V	$I_{OH} = -12$ mA	
V_{OL}	Output LOW Voltage	2.7			0.2	V	$I_{OL} = 100$ μA	
		3.0			0.8	V	$I_{OL} = 12$ mA	
$I_{I(HOLD)}$ (Note 5)	Bushold Input Minimum Drive	3.0	75			μA	$V_I = 0.8V$	
			-75			μA	$V_I = 2.0V$	
$I_{I(OD)}$ (Note 5)	Bushold Input Over-Drive Current to Change State	3.0	500			μA	(Note 6)	
			-500			μA	(Note 7)	
I_I	Input Current	3.6			10	μA	$V_I = 5.5V$	
		Control Pins	3.6			±1	μA	$V_I = 0V$ or V_{CC}
		Data Pins	3.6			-5	μA	$V_I = 0V$
I_{OFF}	Power Off Leakage Current	0				1	μA	$V_I = V_{CC}$
						±100	μA	$0V \leq V_I$ or $V_O \leq 5.5V$
$I_{PU/PD}$	Power up/down 3-STATE Output Current	0-1.5V			±100	μA	$V_O = 0.5V$ to $3.0V$ $V_I = GND$ or V_{CC}	
I_{OZL}	3-STATE Output Leakage Current	3.6			-5	μA	$V_O = 0.5V$	
I_{OZH}	3-STATE Output Leakage Current	3.6			5	μA	$V_O = 3.0V$	
I_{OZH+}	3-STATE Output Leakage Current	3.6			10	μA	$V_{CC} < V_O \leq 5.5V$	
I_{CCH}	Power Supply Current	3.6			0.19	mA	Outputs HIGH	
I_{CCL}	Power Supply Current	3.6			5	mA	Outputs LOW	
I_{CCZ}	Power Supply Current	3.6			0.19	mA	Outputs Disabled	

DC Electrical Characteristics (Continued)

Symbol	Parameter	V _{CC} (V)	T _A = -40°C to +85°C			Units	Conditions
			Min	Typ (Note 4)	Max		
I _{CCZ} ⁺	Power Supply Current	3.6			0.19	mA	V _{CC} ≤ V _O ≤ 5.5V, Outputs Disabled
ΔI _{CC}	Increase in Power Supply Current (Note 8)	3.6			0.2	mA	One Input at V _{CC} - 0.6V Other Inputs at V _{CC} or GND

Note 4: All typical values are at V_{CC} = 3.3V, T_A = 25°C.

Note 5: Applies to bushold versions only (74LVTH2240).

Note 6: An external driver must source at least the specified current to switch from LOW-to-HIGH.

Note 7: An external driver must sink at least the specified current to switch from HIGH-to-LOW.

Note 8: This is the increase in supply current for each, input that is at the specified voltage level rather than V_{CC} or GND.

Dynamic Switching Characteristics (Note 9)

Symbol	Parameter	V _{CC} (V)	T _A = 25°C			Units	Conditions C _L = 50 pF, R _L = 500Ω (Note 10)
			Min	Typ	Max		
V _{OLP}	Quiet Output Maximum Dynamic V _{OL}	3.3		0.8		V	
V _{OLV}	Quiet Output Minimum Dynamic V _{OL}	3.3		-0.8		V	

Note 9: Characterized in SOIC package. Guaranteed parameter, but not tested.

Note 10: Max number of outputs defined as (n). n-1 data inputs are driven 0V to 3V. Output under test held LOW.

AC Electrical Characteristics

Symbol	Parameter	T _A = -40°C to +85°C C _L = 50 pF, R _L = 500Ω					Units
		V _{CC} = 3.3V ± 0.3V			V _{CC} = 2.7V		
		Min	Typ (Note 11)	Max	Min	Max	
t _{PLH} t _{PHL}	Propagation Delay Data to Output	1.0		4.0	1.0	4.8	ns
		1.0		4.1	1.0	4.4	
t _{PZH} t _{PZL}	Output Enable Time	1.0		5.0	1.0	6.0	ns
		1.1		5.0	1.1	5.6	
t _{PHZ} t _{PLZ}	Output Disable Time	1.9		4.8	1.9	5.5	ns
		1.8		4.5	1.8	4.5	
t _{OSSL} t _{OSSH}	Output to Output Skew (Note 12)			1.0		1.0	ns

Note 11: All typical values are at V_{CC} = 3.3V, T_A = 25°C.

Note 12: Skew is defined as the absolute value of the difference between the actual propagation delay for any two separate outputs of the same device. The specification applies to any outputs switching in the same direction, either HIGH-to-LOW (t_{OSSL}) or LOW-to-HIGH (t_{OSSH}).

Capacitance (Note 13)

Symbol	Parameter	Conditions	Typical	Units
C _{IN}	Input Capacitance	V _{CC} = 0V, V _I = 0V or V _{CC}	3	pF
C _{OUT}	Output Capacitance	V _{CC} = 3.0V, V _O = 0V or V _{CC}	6	pF

Note 13: Capacitance is measured at frequency f = 1 MHz, per MIL-STD-883B, Method 3012.

Physical Dimensions inches (millimeters) unless otherwise noted



**20-Lead Small Outline Integrated Circuit (SOIC), JEDEC MS-013, 0.300" Wide
Package Number M20B**

Physical Dimensions inches (millimeters) unless otherwise noted (Continued)

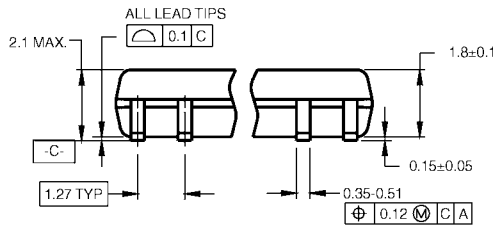
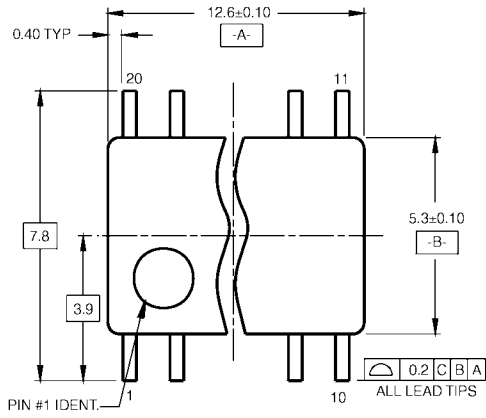

DIMENSIONS ARE IN MILLIMETERS

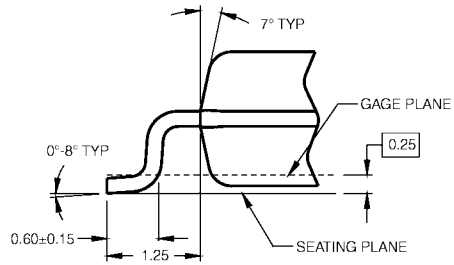
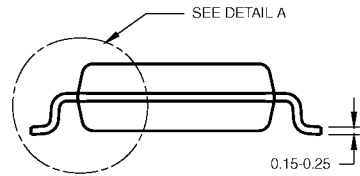

DETAIL A

NOTES:

- A. CONFORMS TO EIAJ EDR-7320 REGISTRATION, ESTABLISHED IN DECEMBER, 1998.
- B. DIMENSIONS ARE IN MILLIMETERS.
- C. DIMENSIONS ARE EXCLUSIVE OF BURRS, MOLD FLASH, AND TIE BAR EXTRUSIONS.

M20DRevB1

Pb-Free 20-Lead Small Outline Package (SOP), EIAJ TYPE II, 5.3mm Wide Package Number M20D

Physical Dimensions inches (millimeters) unless otherwise noted (Continued)

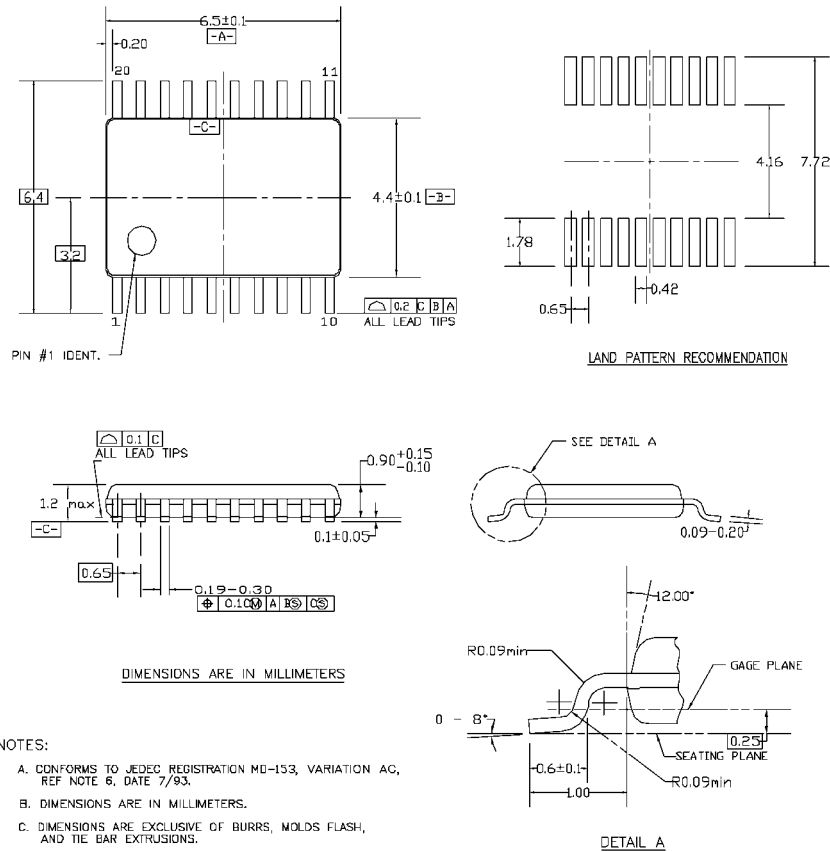

MTC20REVD1

20-Lead Thin Shrink Small Outline Package (TSSOP), JEDEC MO-153, 4.4mm Wide Package Number MTC20

Fairchild does not assume any responsibility for use of any circuitry described, no circuit patent licenses are implied and Fairchild reserves the right at any time without notice to change said circuitry and specifications.

LIFE SUPPORT POLICY

FAIRCHILD'S PRODUCTS ARE NOT AUTHORIZED FOR USE AS CRITICAL COMPONENTS IN LIFE SUPPORT DEVICES OR SYSTEMS WITHOUT THE EXPRESS WRITTEN APPROVAL OF THE PRESIDENT OF FAIRCHILD SEMICONDUCTOR CORPORATION. As used herein:

- Life support devices or systems are devices or systems which, (a) are intended for surgical implant into the body, or (b) support or sustain life, and (c) whose failure to perform when properly used in accordance with instructions for use provided in the labeling, can be reasonably expected to result in a significant injury to the user.
- A critical component in any component of a life support device or system whose failure to perform can be reasonably expected to cause the failure of the life support device or system, or to affect its safety or effectiveness.

www.fairchildsemi.com