

Fast Recovery Diode Module 100 Amperes/3300 Volts

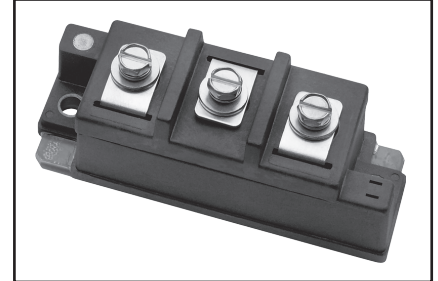
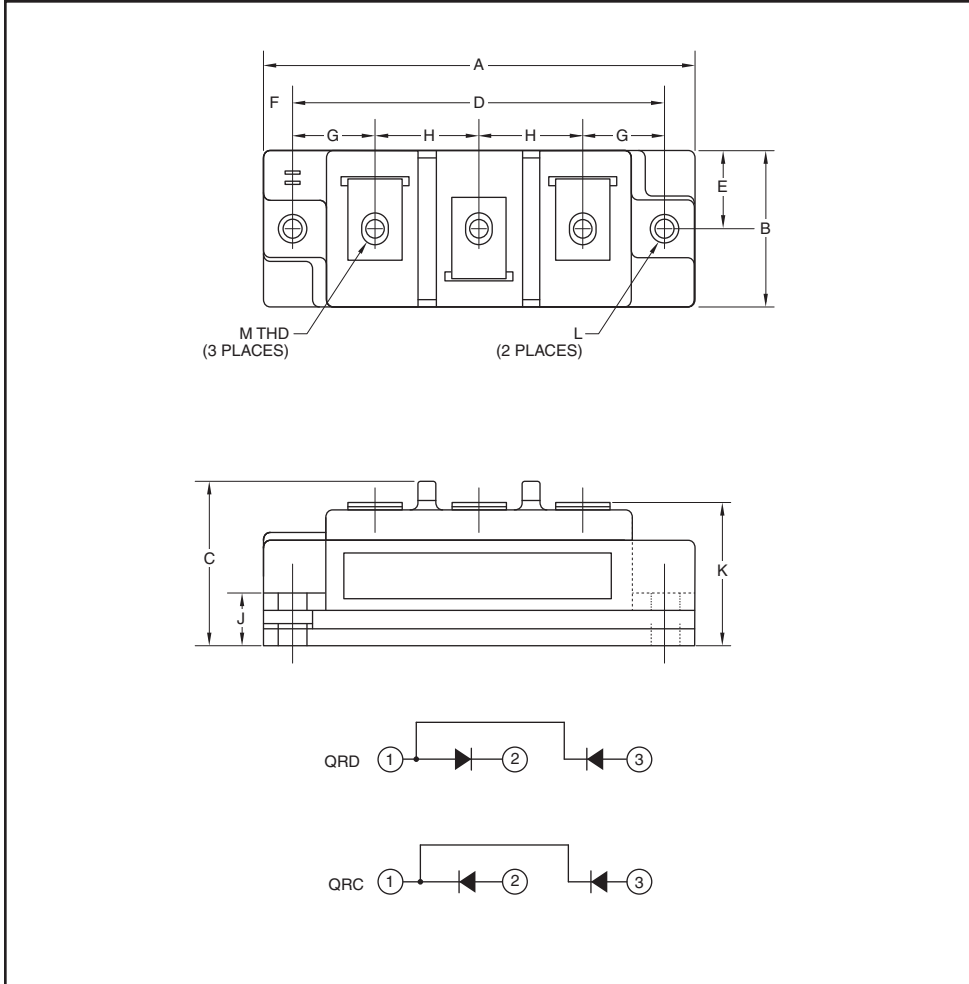

Description:

High voltage diodes feature highly insulating housings that offer enhanced protection by means of greater creepage and strike clearance distance for many demanding applications like medium voltage drives and auxiliary traction applications.

Features:

- Alumina Ceramic Substrate for Low Thermal Impedance
- Copper Baseplate
- Fast Recovery Time (1.2 μ s max.)
- Industry Standard Packages Allow Common Bus Work to Complementary High Isolation Diodes
- No Additional Insulation Components Required

Applications:

- High Voltage Power Supplies
- Medium Voltage Drives
- Motor Drives
- Traction

Outline Drawing and Circuit Diagram

Dimensions	Inches	Millimeters
A	3.70	94.0
B	1.34	34.0
C	1.40	35.6
D	3.15	80.0
E	0.67	17.0
F	0.28	6.99

Dimensions	Inches	Millimeters
G	0.67	17.1
H	0.91	23.0
J	0.36	9.0
K	1.18	30.0
L	0.216 Dia.	5.5 Dia.
M	#10-32	#10-32

QR_3310002
Fast Recovery Diode Module
 100 Amperes/3300 Volts

Absolute Maximum Ratings, $T_j = 25^\circ\text{C}$ unless otherwise specified

Ratings	Symbol	QRD3310002	QRC3310002	Units
Repetitive Peak Reverse Blocking Voltage	V_{RRM}	3300		Volts
Non-Repetitive Peak Reverse Blocking Voltage	V_{RSM}	$V_{RRM} + 100$		Volts
Average Forward Current	$I_{F(av)}$	$T_C = 80^\circ\text{C}$	60	Amperes
		$T_C = 25^\circ\text{C}$	90	Amperes
Forward Current (Pulse)	I_{FM}	200		Amperes
Operating Junction Temperature	T_j	-40 to 150		$^\circ\text{C}$
Storage Temperature	T_{stg}	-40 to 150		$^\circ\text{C}$
Maximum Mounting Torque, #10-32 Mounting Screw	—	26		in-lb
Maximum Terminal Torque, #10-32 Terminal Screw	—	26		in-lb
Module Weight (Typical)	—	250		Grams
V Isolation (60 Hz, Circuit to Base, All Terminals Shorted, $t = 1$ sec.)	V_{RMS}	6000		Volts

IGBT Electrical Characteristics, $T_j = 25^\circ\text{C}$ unless otherwise specified

Characteristics	Symbol	Test Conditions	Min.	Typ.	Max.	Units
Peak Reverse Leakage Current	I_{RRM}	Rated V_{RRM}	—	—	5	mA
Peak On-State Voltage	V_{FM}	$I_F = 100\text{A}$	—	3.3	4.3	Volts
Reverse Recovery Time	t_{rr}	$I_F = 100\text{A}$, $di/dt = -200\text{A}/\mu\text{s}$	—	—	1.2	μs
Reverse Recovery Charge	Q_{rr}	$I_F = 100\text{A}$, $di/dt = -200\text{A}/\mu\text{s}$	—	25	—	μC

Thermal and Mechanical Characteristics, $T_j = 25^\circ\text{C}$ unless otherwise specified

Characteristics	Symbol	Test Conditions	Min.	Typ.	Max.	Units
Thermal Resistance, Junction to Case	$R_{th(j-c)Q}$	Per Diode	—	—	0.20	$^\circ\text{C}/\text{W}$
Thermal Resistance, Case to Sink Lubricated	$R_{th(c-s)Q}$	Per Module	—	—	0.05	$^\circ\text{C}/\text{W}$

QR_3310002
Fast Recovery Diode Module
 100 Amperes/3300 Volts

MAXIMUM ON-STATE FORWARD VOLTAGE DROP CHARACTERISTICS
 ($T_j = 150^\circ\text{C}$)

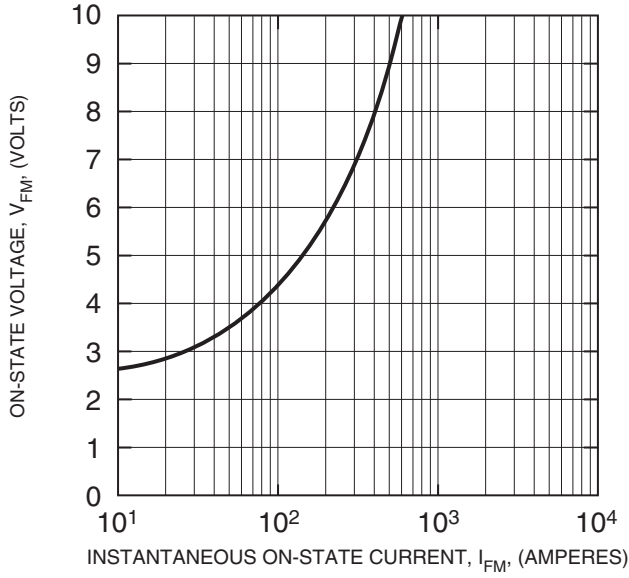

MAXIMUM TRANSIENT THERMAL IMPEDANCE CHARACTERISTICS
 (JUNCTION TO CASE)

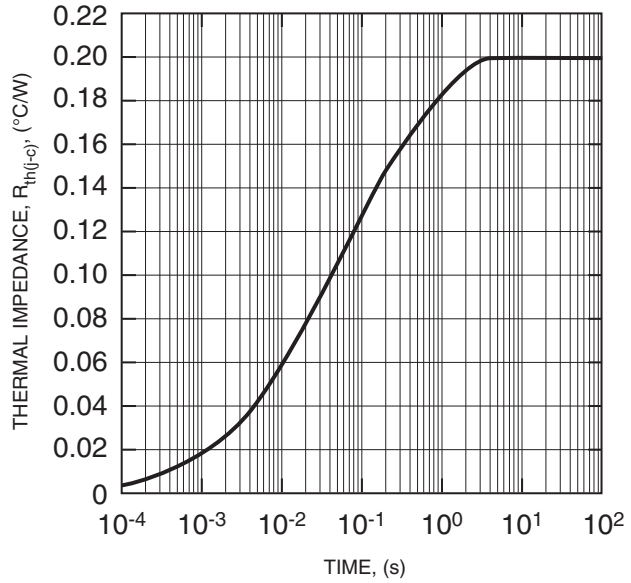

MAXIMUM ON-STATE POWER DISSIPATION
 (SINUSOIDAL WAVEFORM)

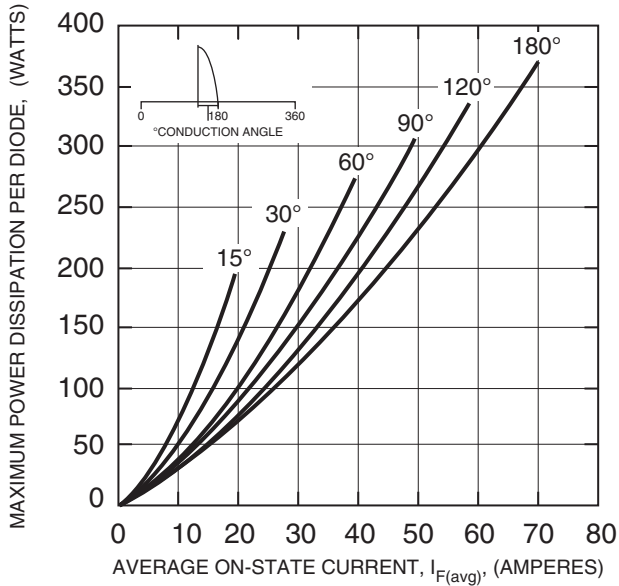

MAXIMUM ALLOWABLE CASE TEMPERATURE
 (SINUSOIDAL WAVEFORM)

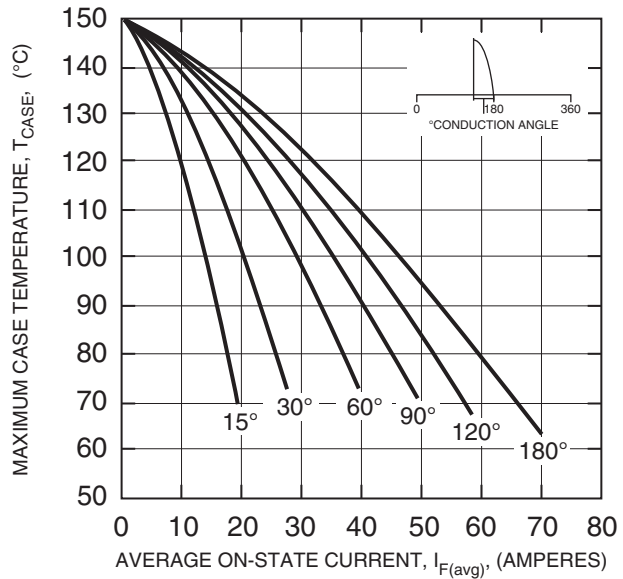

Information presented is based upon manufacturers testing and projected capabilities. This information is subject to change without notice. The manufacturer makes no claim as to the suitability of use, reliability, capability, or future availability of this product.

QR_3310002
Fast Recovery Diode Module
 100 Amperes/3300 Volts

**MAXIMUM ON-STATE
 POWER DISSIPATION
 (RECTANGULAR WAVEFORM)**

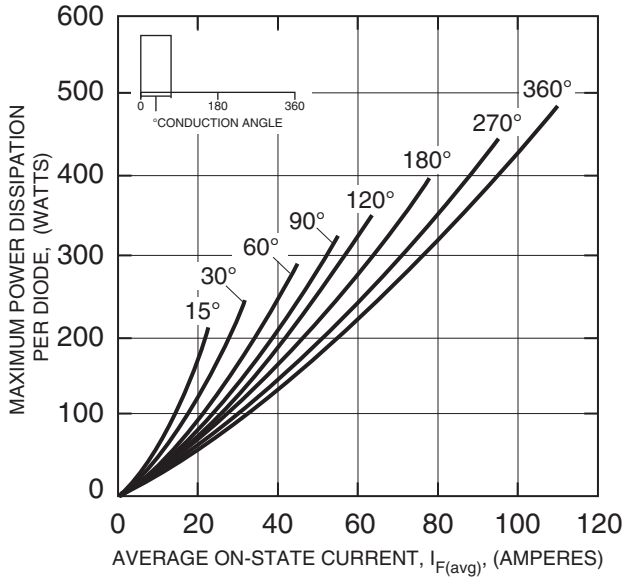

**MAXIMUM ALLOWABLE
 CASE TEMPERATURE
 (RECTANGULAR WAVEFORM)**

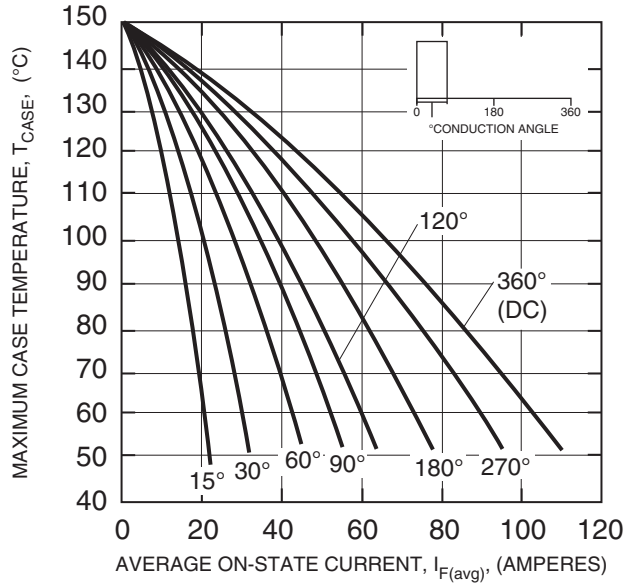

Information presented is based upon manufacturers testing and projected capabilities. This information is subject to change without notice. The manufacturer makes no claim as to the suitability of use, reliability, capability, or future availability of this product.