

THESE DRAWINGS ARE THE PROPERTY OF QUALTEK ELECTRONICS AND NOT TO BE REPRODUCED FOR OR COMMUNICATED TO A THIRD PARTY WITHOUT THE EXPRESS WRITTEN PERMISSION OF AN OFFICER OF QUALTEK ELECTRONICS.

REVISION			
REV.	DESCRIPTION	DATE	APPROVED

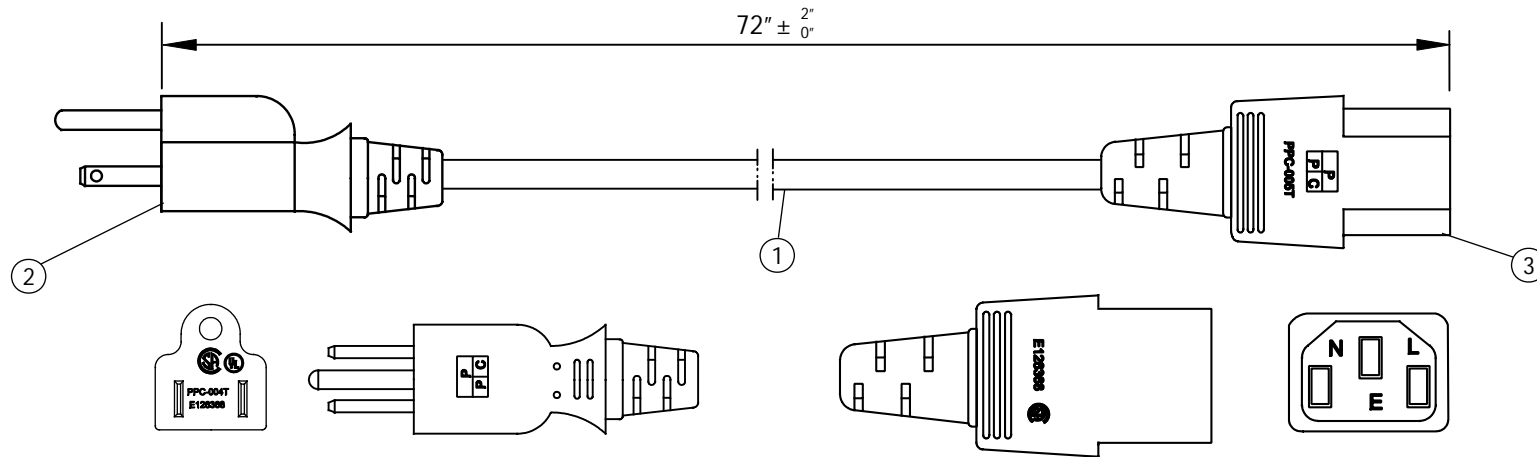

CONTROLLED

NOTES:

1. CORDAGE: SJT, 18AWG / 3C, UNSHIELDED, NA COLOR CODE, TEMP. RATING: 105°C, RATING: 125V 10A, JACKET COLOR: BLACK
2. PLUG: NEMA 5-15P
3. CONNECTOR: IEC 60320 C13
4. APPROVALS: UL, CSA
5. ROHS COMPLIANT

Dim range (mm)		Tolerance +/- (mm)		Qualtek Electronics Corp. PPC DIVISION		
0-1	0.15	Part Number: 412007-01		RoHS Compliant		
1-6	0.20	Description: POWER CORD				
6-18	0.30	UNIT: in				
18-50	0.50	Drawn / Date	Checked / Date	Approved / Date		
50-120	0.70	R. Nuti 09-10-20	09-10-20	LY / 09-10-20		
120-250	0.90					
250-500	1.20					