

Power Common Mode Chokes



ACMP-7038 Series

Request Samples



Check Inventory



7.0 x 6.0 x 3.8 mm
RoHS/RoHS II Compliant
MSL Level = 1

Features

- Commercial Grade
- PPAP ready and supported
- Excellent impedance characteristics
- Rated current up to 15A
- Extremely Low DCR

Applications

- DC power line common mode noise suppression.
- Switch Mode Power Supplies and regulators
- Variable Frequency Drives
- AC/DC power rectifiers

Electrical Specifications

Part Number	Impedance (Ω) @100MHz		DCR (mΩ)	Rated Current (A)	Rated Voltage (Vdc)	Insulation Resistance (MΩ)
	Min	Typ.	Max	Typ.	Max	Min
ACMP-7038-700	40	70	5	15	125	10
ACMP-7038-141	100	140	10	9	125	10
ACMP-7038-301	225	300	10	5	125	10
ACMP-7038-351	275	350	10	5	125	10
ACMP-7038-701	500	700	15	4	125	10
ACMP-7038-102	800	1020	17	3	125	10
ACMP-7038-132	910	1300	21	2.5	125	10
ACMP-7038-222	1700	2200	50	1.2	125	10
ACMP-7038-272	2000	2700	63	1.0	125	10
ACMP-7038-302	2500	3000	75	0.9	125	10

Rated Current is based on an Irms temperature rise of 40°C

Operating Temperature: -40°C to +125°C (Including self-heating)

Storage (in original packaging): <40°C, <60% RH

ACMP-7038 Series is RoHS Compliant and Pb free



5101 Hidden Creek Ln Spicewood TX 78669
Phone: 512-371-6159 | Fax: 512-351-8858
For terms and conditions of sales, please visit:
www.abracon.com

REVISION: IR 06-29-22

ABRACON IS
ISO9001-2015
CERTIFIED

Power Common Mode Chokes



ACMP-7038 Series

Request Samples



Check Inventory



7.0 x 6.0 x 3.8 mm
RoHS/RoHS II Compliant
MSL Level = 1

Electrical Specifications (Cont'd)

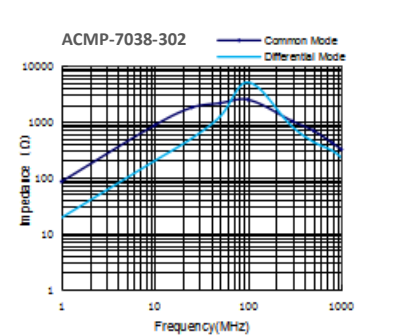
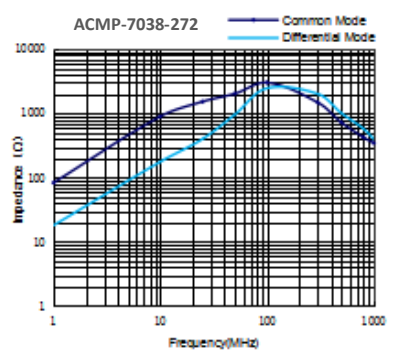
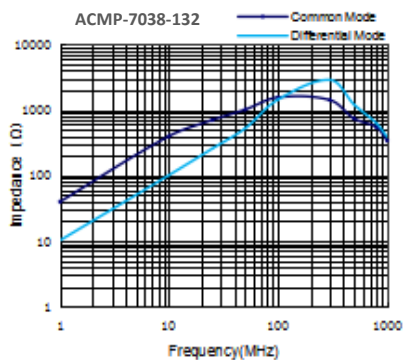
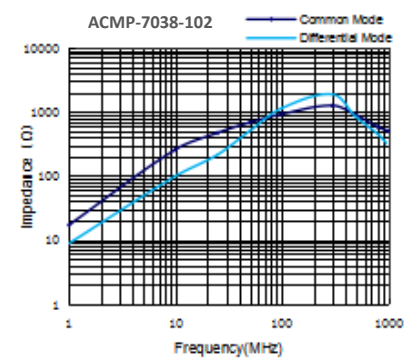
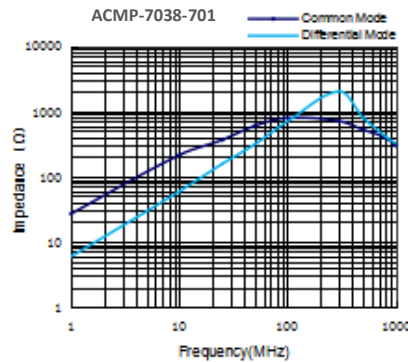
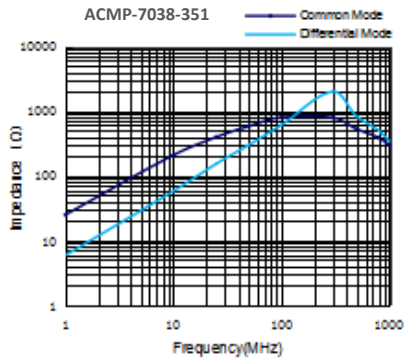
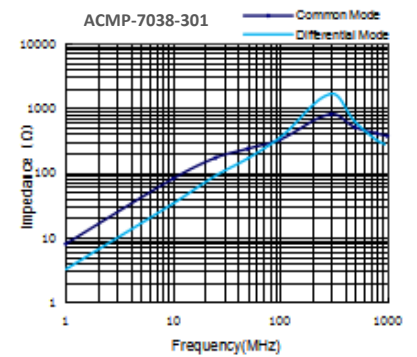
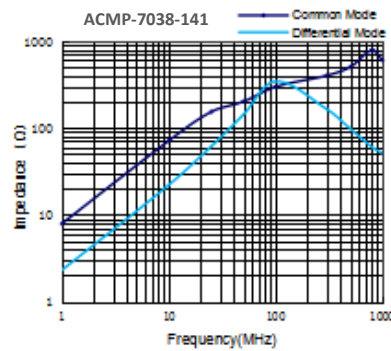
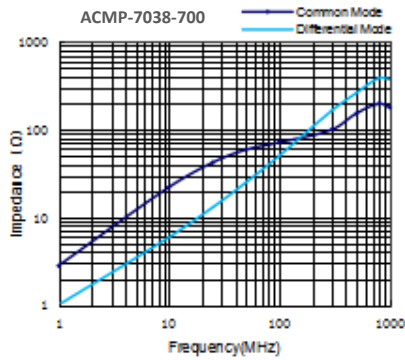

Power Common Mode Chokes



ACMP-7038 Series

Request Samples



Check Inventory



7.0 x 6.0 x 3.8 mm
RoHS/RoHS II Compliant
 MSL Level = 1

Mechanical Specifications

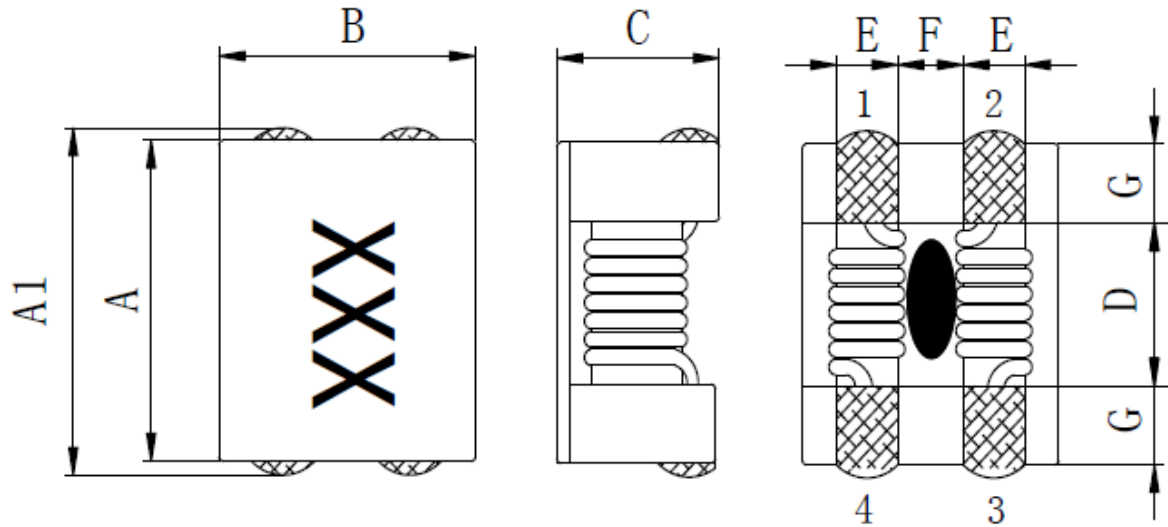

A	A1	B	C	D	E	F	G
7.0 ± 0.5	7.5 ± 0.6	6.0 ± 0.5	3.8 MAX	3.5 Ref.	1.5 Ref.	1.5 Ref.	1.7 Ref.

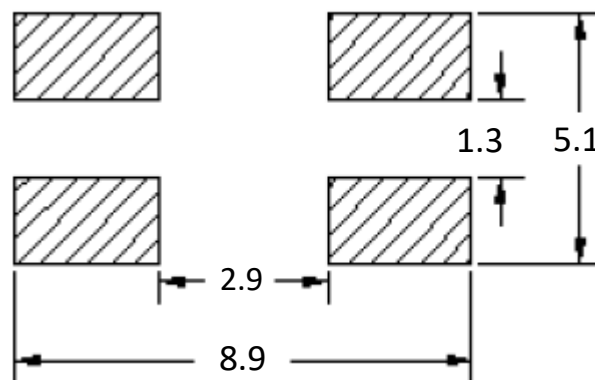

Recommended Layout

Dimensions: mm

Power Common Mode Chokes



ACMP-7038 Series

Request Samples



Check Inventory



7.0 x 6.0 x 3.8 mm
RoHS/RoHS II Compliant
MSL Level = 1

Schematic

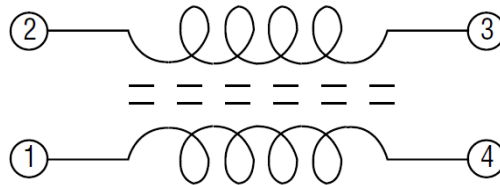

Materials

Description	Specification
Core	Ferrite core
Wire	Enameled copper wire
Base	Plastic
Adhesive	Epoxy resin
Terminal	Sn/Cu
Ink	White

Part Identification

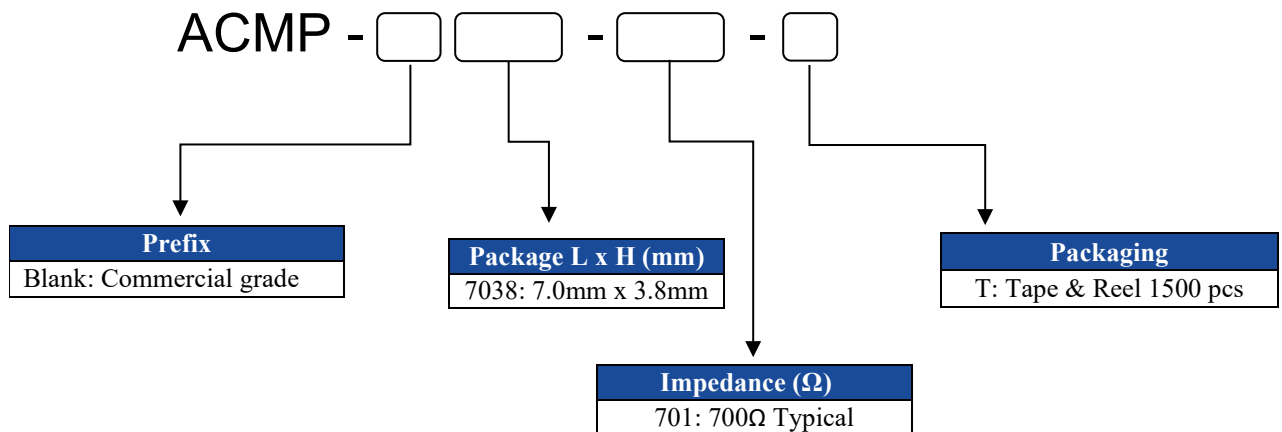

Power Common Mode Chokes



ACMP-7038 Series

Request Samples



Check Inventory



7.0 x 6.0 x 3.8 mm
RoHS/RoHS II Compliant
MSL Level = 1

Reflow Profile

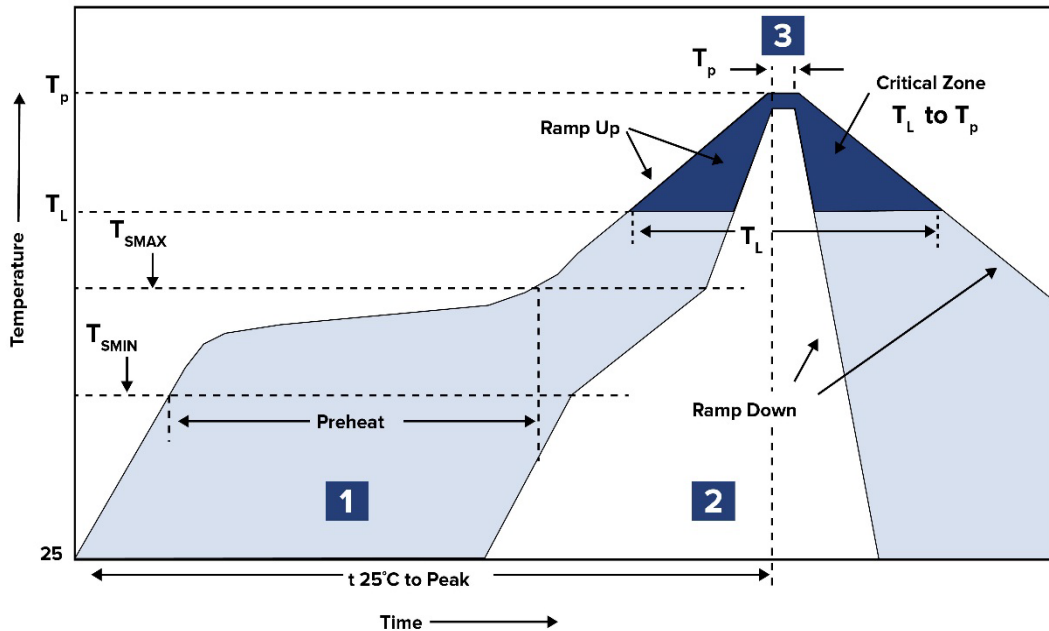

Zone	Description	Temperature	Times
1	Preheat	$T_{SMIN} \sim T_{SMAX}$ 150°C ~ 190°C	60 ~ 120 sec.
2	Reflow	T_L 240°C	20 ~ 40 sec.
3	Peak heat	T_P 260°C Max.	5 sec. Max

1~2 °C/Sec. Ramp

Power Common Mode Chokes



ACMP-7038 Series

Request Samples



Check Inventory



7.0 x 6.0 x 3.8 mm
RoHS/RoHS II Compliant
MSL Level = 1

Packing

Tape & Reel: 1500pcs/reel

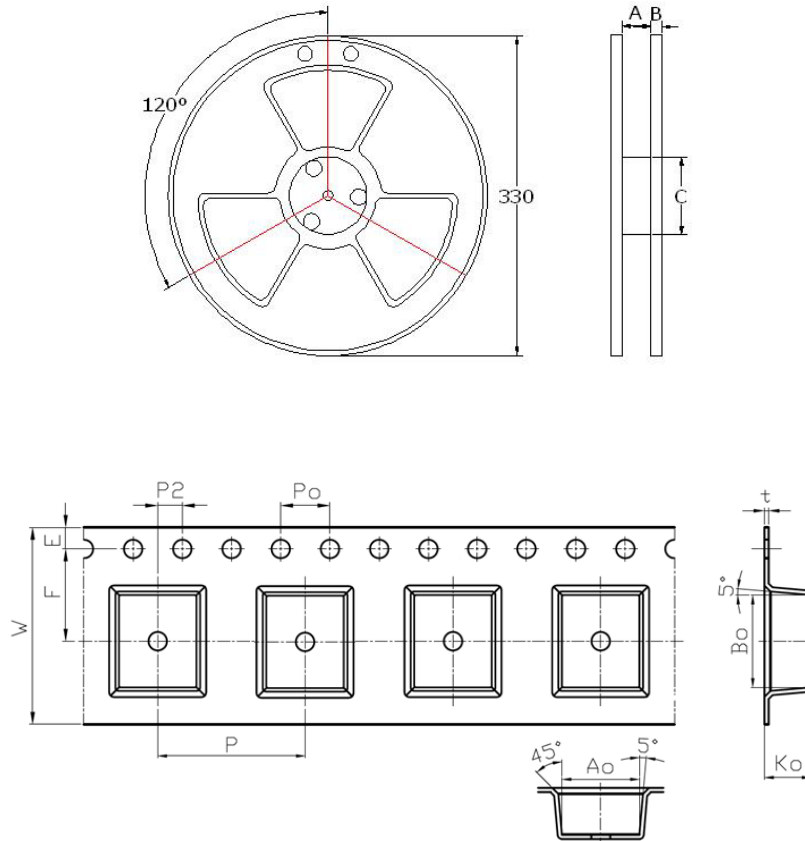

W	P	P0	P2	D0	E	F	A0	B0	K0
16 ± 0.30	12 ± 0.10	4.0 ± 0.10	2.0 ± 0.10	1.5 ± 0.10	1.75 ± 0.10	7.5 ± 0.10	6.35 ± 0.10	7.85 ± 0.10	3.8 ± 0.10

Dimensions: mm

ATTENTION: Abracon LLC's products are COTS – Commercial-Off-The-Shelf products; suitable for Commercial, Industrial and, where designated, Automotive Applications. Abracon's products are not specifically designed for Military, Aviation, Aerospace, Life-dependent Medical applications or any application requiring high reliability where component failure could result in loss of life and/or property. For applications requiring high reliability and/or presenting an extreme operating environment, written consent and authorization from Abracon LLC is required. Please contact Abracon LLC for more information.



5101 Hidden Creek Ln Spicewood TX 78669
 Phone: 512-371-6159 | Fax: 512-351-8858
 For terms and conditions of sales, please visit:
www.abracon.com

REVISION: IR 06-29-22

ABRACON IS
 ISO9001-2015
 CERTIFIED