



rfPIC™
Development Kit 1
User's Guide

Note the following details of the code protection feature on Microchip devices:

- Microchip products meet the specification contained in their particular Microchip Data Sheet.
- Microchip believes that its family of products is one of the most secure families of its kind on the market today, when used in the intended manner and under normal conditions.
- There are dishonest and possibly illegal methods used to breach the code protection feature. All of these methods, to our knowledge, require using the Microchip products in a manner outside the operating specifications contained in Microchip's Data Sheets. Most likely, the person doing so is engaged in theft of intellectual property.
- Microchip is willing to work with the customer who is concerned about the integrity of their code.
- Neither Microchip nor any other semiconductor manufacturer can guarantee the security of their code. Code protection does not mean that we are guaranteeing the product as "unbreakable."

Code protection is constantly evolving. We at Microchip are committed to continuously improving the code protection features of our products. Attempts to break microchip's code protection feature may be a violation of the Digital Millennium Copyright Act. If such acts allow unauthorized access to your software or other copyrighted work, you may have a right to sue for relief under that Act.

Information contained in this publication regarding device applications and the like is intended through suggestion only and may be superseded by updates. It is your responsibility to ensure that your application meets with your specifications. No representation or warranty is given and no liability is assumed by Microchip Technology Incorporated with respect to the accuracy or use of such information, or infringement of patents or other intellectual property rights arising from such use or otherwise. Use of Microchip's products as critical components in life support systems is not authorized except with express written approval by Microchip. No licenses are conveyed, implicitly or otherwise, under any intellectual property rights.

Trademarks

The Microchip name and logo, the Microchip logo, KEELOQ, MPLAB, PIC, PICmicro, PICSTART, PRO MATE and PowerSmart are registered trademarks of Microchip Technology Incorporated in the U.S.A. and other countries.

FilterLab, microID, MXDEV, MXLAB, PICMASTER, SEEVAL and The Embedded Control Solutions Company are registered trademarks of Microchip Technology Incorporated in the U.S.A.

Accuron, Application Maestro, dsPIC, dsPICDEM, dsPICDEM.net, ECONOMONITOR, FanSense, FlexROM, fuzzyLAB, In-Circuit Serial Programming, ICSP, ICEPIC, microPort, Migratable Memory, MPASM, MPLIB, MPLINK, MPSIM, PICC, PICKit, PICDEM, PICDEM.net, PowerCal, PowerInfo, PowerMate, PowerTool, rLAB, rPIC, Select Mode, SmartSensor, SmartShunt, SmartTel and Total Endurance are trademarks of Microchip Technology Incorporated in the U.S.A. and other countries.

Serialized Quick Turn Programming (SQTP) is a service mark of Microchip Technology Incorporated in the U.S.A.

All other trademarks mentioned herein are property of their respective companies.

© 2003, Microchip Technology Incorporated, Printed in the U.S.A., All Rights Reserved.

 Printed on recycled paper.



Microchip received QS-9000 quality system certification for its worldwide headquarters, design and wafer fabrication facilities in Chandler and Tempe, Arizona in July 1999. The Company's quality system processes and procedures are QS-9000 compliant for its PICmicro® 8-bit MCUs, KEELOQ® code hopping devices, Serial EEPROMs and microperipheral products. In addition, Microchip's quality system for the design and manufacture of development systems is ISO 9001 certified.



rfPIC™ Development Kit 1 User's Guide

Table of Contents

Preface	1
Chapter 1. Getting Started	
1.1 Introduction	5
1.2 Highlights	5
1.3 rfPIC Development Kit 1 Contents	5
1.4 Getting Started with the rfPIC Development Kit 1	6
1.4.1 Preparing the Receiver Module for Operation	6
1.4.2 Preparing the Transmitter Module for Operation	7
1.4.3 Demonstration Operation	7
1.5 Demonstration Programs and HEX Files	7
Chapter 2. Demonstration Programs	
2.1 Introduction	9
2.2 Highlights.....	9
2.3 About the Demonstration Programs	9
2.4 XMIT_DEMO	10
2.5 RCVR_DEMO	10
2.6 RCVR_ANALOG_DISPLAY	10
2.7 XMIT_TEST.....	11
2.7.1 Peak Power Measurement	11
2.7.2 Data Modulation and Bandwidth Measurement	11
2.8 Presentation Pal	11
2.8.1 USB Firmware - pres_pal.hex	11
2.8.2 Transmitter Firmware - prespal_xmit.hex	12
2.9 Programming Templates	12
Chapter 3. rfRXD0420 Receiver Module	
3.1 Introduction	13
3.2 Highlights	13
3.3 rfRXD0420 Description	14
3.4 rfRXD0420 Schematic	15
3.5 PCB Layout	16
3.6 Gerber Files	16
3.7 rfRXD0420 Receiver Module Bill-of-Materials	17
3.8 Third Party Component Suppliers	18

rfPIC™ Development Kit 1 User's Guide

Chapter 4. rfPIC12F675 Transmitter Module

4.1 Introduction	19
4.2 Highlights	19
4.3 rfPIC12F675 Description	19
4.3.1 Power Requirements	20
4.3.2 Programming the rfPIC12F675	20
4.3.3 Optional 8-pin Socket U2	20
4.4 rfPIC12F675 Schematic	22
4.5 PCB Layout	23
4.6 Gerber Files	24
4.7 rfPIC12F675 Transmitter Module Bill-of-Materials	25
4.8 Third Party Component Suppliers	26

Chapter 5. Troubleshooting

5.1 Introduction	27
5.2 Frequently Asked Questions	27
5.2.1 Devices on the PICkit™ Starter Kit Have No Power?	27
5.2.2 Programmer Not Found	28
5.2.3 Insert Device	28
5.2.4 Checksum Verify Failed	29

Worldwide Sales and Service	32
--	-----------



rfPIC™ Development Kit 1 User's Guide

Preface

INTRODUCTION

This chapter contains general information about this user's guide and customer support that will be useful prior to using the rfPIC™ Development Kit 1.

HIGHLIGHTS

Items discussed in this Preface are:

- About this Guide
- Warranty Registration
- Recommended Reading
- Troubleshooting
- Microchip On-Line Support
- Customer Change Notification Service
- Customer Support

ABOUT THIS GUIDE

This document describes how to use the rfPIC Development Kit 1. The manual layout is as follows:

- **Chapter 1: Getting Started** – Step by step instructions on how to use your rfPIC Development Kit 1.
- **Chapter 2: Demonstration Programs** – Programs to familiarize the developer with the rfPIC and rfRXD products and provide a starting point for future development.
- **Chapter 3: rfRXD0420 Receiver Module** – Description, schematics, PCB layout, and Bill-of-Materials.
- **Chapter 4: rfPIC12F675 Transmitter Module** – Description, schematics, PCB layout, and Bill-of-Materials.
- **Chapter 5: Troubleshooting** – This chapter describes common problems associated with using the rfPIC Development Kit 1 and steps on how to resolve them.
- **Worldwide Sales and Service** – A list of Microchip sales and service locations and telephone numbers worldwide.

Conventions Used in This Guide

This manual uses the following documentation conventions:

TABLE 1: DOCUMENTATION CONVENTIONS

Description	Represents	Examples
Code (Courier font):		
Plain characters	Sample code Filenames and paths	<code>#define START</code> <code>c:\autoexec.bat</code>
Angle brackets: < >	Variables	<label>, <exp>
Square brackets []	Optional arguments	MPASMWIN [main.asm]
Curly brackets and pipe character: { }	Choice of mutually exclusive arguments; An OR selection	errorlevel {0 1}
Lower case characters in quotes	Type of data	"filename"
Ellipses...	Used to imply (but not show) additional text that is not relevant to the example	list ["list_option...", "list_option"]
0xnnn	A hexadecimal number where n is a hexadecimal digit	0xFFFF, 0x007A
Italic characters	A variable argument; it can be either a type of data (in lower case characters) or a specific example (in upper case characters).	char isascii (char, ch);
Interface (Arial font):		
Underlined, italic text with right arrow	A menu selection from the menu bar	<u>File > Save</u>
Bold characters	A window or dialog button to click	OK, Cancel
Characters in angle brackets < >	A key on the keyboard	<Tab>, <Ctrl-C>
Documents (Arial font):		
Italic characters	Referenced books	<i>MPLAB® IDE User's Guide</i>

Documentation Updates

All documentation becomes dated, and this user's guide is no exception. Since the rfPIC™ Development Kit 1 User's Guide and other Microchip tools are constantly evolving to meet customer needs, some rfPIC Development Kit 1 actual dialogs and/or tool descriptions may differ from those in this document. Please refer to our web site to obtain the latest documentation available.

Documentation Numbering Conventions

Documents are numbered with a "DS" number. The number is located on the bottom of each page, in front of the page number. The numbering convention for the DS Number is: DSXXXXXA,

where:

- XXXXX = The document number.
- A = The revision level of the document.

WARRANTY REGISTRATION

Please complete the enclosed Warranty Registration Card and mail it promptly. Sending in your Warranty Registration Card entitles you to receive new product updates. Interim software releases are available at the Microchip web site.

RECOMMENDED READING

Other useful documents are listed below:

rfPIC12F675K/675F/675H Data Sheet (DS70091)

Consult this document for information regarding the rfPIC12F675 20-pin FLASH-based 8-bit CMOS microcontroller with UHF ASK/FSK transmitter device specifications.

rfRXD0420/0920 Data Sheet (DS70090)

Consult this document for information regarding the rfRXD0420 UHF ASK/FSK/FM receiver device specifications.

PIC12F629/675 Data Sheet (DS41190)

Consult this document for information regarding the PIC12F629/675 8-pin FLASH-based 8-bit CMOS microcontroller device specifications.

PIC16F630/676 Data Sheet (DS40039)

Consult this document for information regarding the PIC16F630/676 14-pin FLASH-based 8-bit CMOS microcontroller device specifications.

PICKit™ 1 FLASH Starter Kit User's Guide (DS40051)

Consult this document for information regarding the PICKit 1 FLASH Starter Kit.

MPLAB® IDE User's Guide (DS51025)

Consult this document for more information pertaining to the installation and features of the MPLAB Integrated Development Environment (IDE) Software.

To obtain these documents, contact the nearest Microchip sales location (see back page). These documents are also available on the Microchip web site at: www.microchip.com.

Application Notes

There are several application notes for the rfPIC products available on the rfPIC™ Development Kit CD-ROM.

Microsoft® Windows® Manuals

This manual assumes that users are familiar with the Microsoft Windows operating system. Many excellent references exist for this software program, and should be consulted for general operation of Windows.

TROUBLESHOOTING

See Chapter 5. "Troubleshooting" for information on common problems.

THE MICROCHIP INTERNET WEB SITE

Microchip provides easy access to our documentation and on-line support through our World Wide Web Site at www.microchip.com. You can download files from the web site or from our FTP site at <ftp://ftp.microchip.com>

CUSTOMER SUPPORT

Users of Microchip products can receive assistance through several channels:

- Distributor or Representative
- Local Sales Office
- Field Application Engineer (FAE)
- Corporate Applications Engineer (CAE)
- Hot line

Customers should call their distributor, representative or field application engineer (FAE) for support. Local sales offices are also available to help customers. See the back cover for a listing of sales offices and locations.

Corporate Applications Engineers (CAEs) may be contacted at (480) 792-7627.

In addition, there is a Systems Information and Upgrade Line. This line provides system users a listing of the latest versions of all of Microchip's development systems software products. Plus, this line provides information on how customers can receive any currently available upgrade kits.

The Hot Line Numbers are:

- 1-800-755-2345 for U.S. and most of Canada, and
- 1-480-792-7302 for the rest of the world

CUSTOMER CHANGE NOTIFICATION SERVICE

Microchip started the customer notification service to help customers stay current on Microchip products with the least amount of effort. Once you subscribe, you will receive E-mail notification whenever we change, update, revise or have errata related to your specified product family or development tool of interest.

Go to the Microchip web site (www.microchip.com) and click on Customer Change Notification. Follow the instructions to register.

The Development Systems product group categories are:

- Compilers
- Emulators
- In-Circuit Debuggers
- MPLAB® IDE
- Programmers

Here is a description of these categories:

Compilers – The latest information on Microchip C compilers and other language tools. These include the MPLAB® C17, MPLAB® C18 and MPLAB® C30 C Compilers; MPASM™ and MPLAB ASM30 assemblers; MPLINK™ and MPLAB® LINK30 linkers; and MPLIB™ and MPLAB® LIB30 librarians.

Emulators – The latest information on Microchip in-circuit emulators. This includes the MPLAB® ICE 2000.

In-Circuit Debuggers – The latest information on Microchip in-circuit debuggers. These include the MPLAB® ICD and MPLAB ICD 2.

MPLAB – The latest information on Microchip MPLAB® IDE, the Windows® Integrated Development Environment for development systems tools. This list is focused on the MPLAB® IDE, MPASM™ simulator, MPLAB IDE Project Manager and general editing and debugging features.

Programmers – The latest information on Microchip device programmers. These include the PRO MATE® II device programmer and PICSTART® Plus development programmer.

Chapter 1. Getting Started

1.1 INTRODUCTION

The rfPIC Development Kit 1 is a demonstration and development kit for the rfPIC12F675K and rfPIC12F675F PICmicro® microcontrollers with UHF ASK/FSK transmitters and rfRXD0420 UHF ASK/FSK/FM receiver. The transmitter and receiver modules are designed to plug into the PICKit™ 1 FLASH Starter Kit expansion header J3 for a low-cost development system.

1.2 HIGHLIGHTS

This chapter discusses:

- rfPIC Development Kit 1 Contents
- Getting Started with the rfPIC Development Kit 1
- Demonstration Programs and HEX Files

1.3 rfPIC DEVELOPMENT KIT 1 CONTENTS

The rfPIC Development Kit 1 contains the following items:

1. rfPIC12F675K 315 MHz Transmitter Module
2. rfPIC12F675F 433.92 MHz Transmitter Module
3. rfRXD0420 315 MHz Receiver Module
4. rfRXD0420 433.92 MHz Receiver Module
5. Programmed PIC16F676
6. rfPIC™ Development Kit 1 Quick Start Guide
7. rfPIC™ Development Kit 1 CD-ROM
8. PICKit 1 FLASH Starter Kit Printed Circuit Board
9. USB Cable
10. PICKit™ 1 FLASH Starter Kit CD-ROM
11. MPLAB® IDE CD-ROM

rfPIC™ Development Kit 1 User's Guide

1.4 GETTING STARTED WITH THE rfPIC DEVELOPMENT KIT 1

The transmitter modules come pre-programmed with a transmitter demonstration. The enclosed PIC16F676 is programmed with a receiver demonstration program. Together they demonstrate an on-off command and control application.

The PICkit 1 FLASH Starter Kit serves as a low-cost development and demonstration platform for the transmitter and receiver modules.

To see your rfPIC Development Kit 1 in action, perform the following steps:

1.4.1 Preparing the Receiver Module for Operation

Step 1:

Familiarize yourself with the PICkit 1 FLASH Starter Kit operation by reading the PICkit™ 1 FLASH Starter Kit User's Guide (DS40051) and performing some of the tutorials. Familiarity with the PICkit Starter Kit will be assumed throughout this user's guide.

Step 2:

Remove power from the PICkit Starter Kit by disconnecting the USB cable.

Step 3:

Remove the PIC12F675 from the PICkit Starter Kit evaluation socket.

Step 4:

Insert the PIC16F676 into the PICkit Starter Kit evaluation socket. See Figure 1-1.

Step 5:

Insert a receiver module (315 or 433.92 MHz) into the PICkit Starter Kit expansion header J3. Make certain that the receiver module is oriented correctly. See Figure 1-1.

Step 6:

Insert the wire antenna into the antenna connector on the receiver module. See Figure 1-1. The wire antenna length is determined by the receive frequency. For the corresponding frequency, insert the following wire antenna:

Frequency	Antenna Length
315 MHz	9-3/8"
433.92 MHz	6-3/4"

FIGURE 1-1: rfPIC RECEIVER DEMONSTRATION

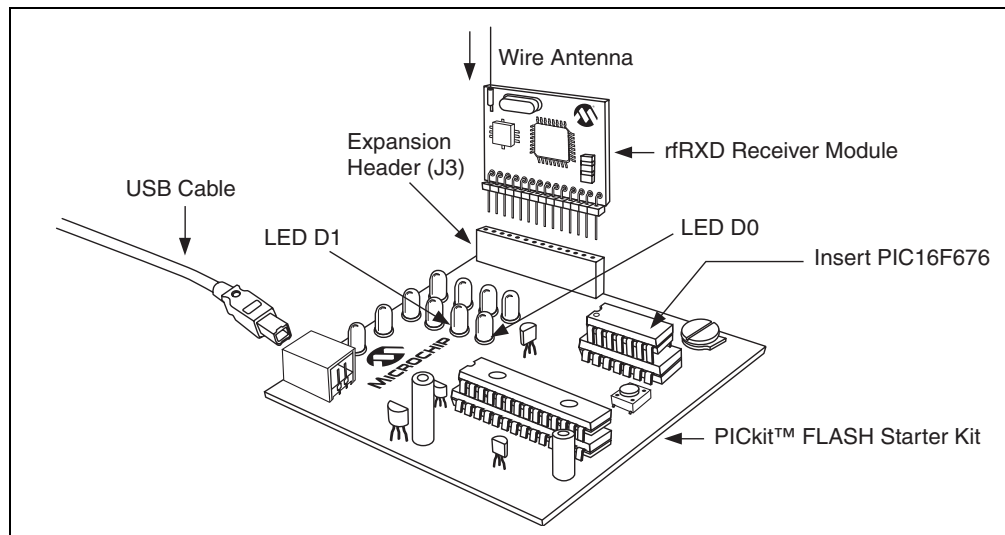

Step 7:

Power-on the PICKit Starter Kit by connecting the USB cable to a personal computer or externally powered USB hub.

Note: There is no interaction between the receiver demonstration program in the PIC16F676 and the personal computer.

The receiver module is ready for operation.

1.4.2 Preparing the Transmitter Module for Operation

Step 1:

Select the transmitter module that matches the receive frequency of the receiver module installed in the PICKit Starter Kit.

Step 2:

Power-on the transmitter module by positioning the shunt jumper to the batt position on P1 (between center pin and batt pin). See Figure 1-2.

The transmitter module is ready for operation.

FIGURE 1-2: rfPIC TRANSMITTER DEMONSTRATION

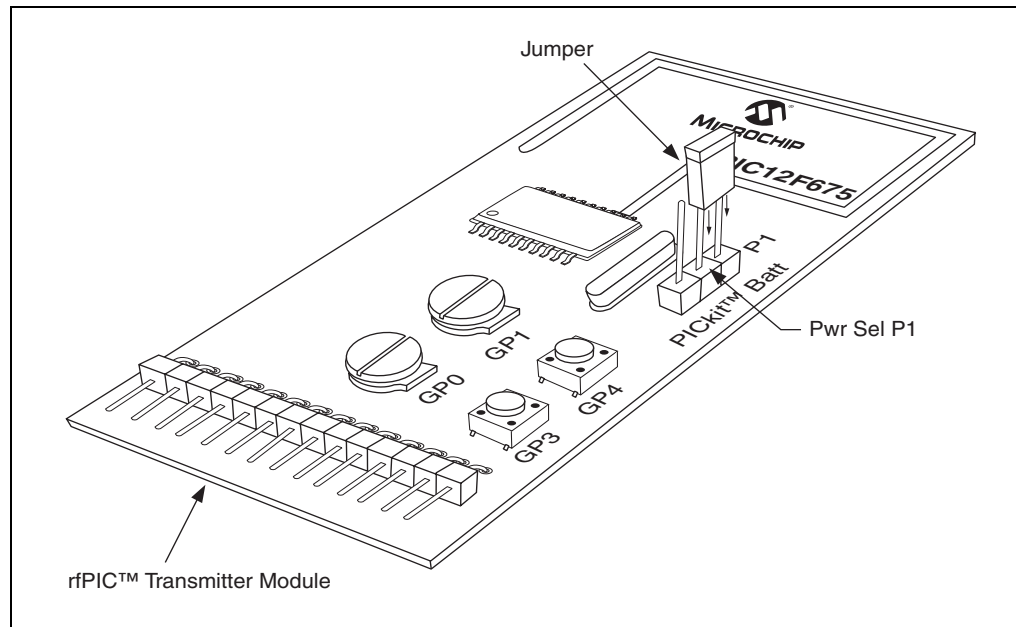

1.4.3 Demonstration Operation

The demonstration program is a simple on-off command and control application. Pressing push button GP3 (SW2) on the transmitter module lights LED D0 on the PICKit Starter Kit. Pressing push button GP4 (SW1) lights LED D1.

1.5 DEMONSTRATION PROGRAMS AND HEX FILES

Additional demonstration programs are provided on the rfPIC™ Development Kit 1 CD-ROM. Chapter 2 provides an explanation of each program. HEX files and program source code are provided. The HEX files can be programmed into the rfPIC transmitter and receiver modules using the PICKit 1 FLASH Starter kit. The source code can be modified and compiled using the MPLAB® Integrated Development Environment (IDE) software and the resulting HEX files programmed in the same manner.

rfPIC™ Development Kit 1 User's Guide

NOTES:

Chapter 2. Demonstration Programs

2.1 INTRODUCTION

The demonstration programs provided on the rfPIC Development Kit 1 CD-ROM give examples of wireless applications. The programs familiarize the developer with the rfPIC and rFRXD products and provide a starting point for future development.

2.2 HIGHLIGHTS

The following demonstration programs are discussed in this chapter:

`xmit_demo` – a transmitter command, control and analog application demonstration

`rcvr_demo` – a receiver command and control application demonstration

`rcvr_analog_display` – a receiver analog demonstration

`xmit_test` – a transmitter test program used for pre-compliance testing and antenna tuning

`Presentation Pal` – programs to turn your rfPIC Development Kit 1 into a wireless presentation helper

`Programming Templates` – a set of thoroughly commented programming templates provided to assist the programmer in getting started with new projects

2.3 ABOUT THE DEMONSTRATION PROGRAMS

The demonstration programs are provided in *.hex format so that the user can immediately program the device and begin testing. They are also available in *.asm format so that the user can study the program source code and comments and as a starting point for future development.

The transmitter module demonstration programs are programmed into the transmitter module by following the steps in Chapter 4 of this User's Guide. The receiver module demonstration programs are programmed into the PIC16F676 by following the steps outlined in the PICKit™ 1 FLASH Starter Kit User's Guide.

2.4 XMIT_DEMO

XMIT-DEMO is the default program that is preprogrammed into the transmitter module. It is used with the receiver module programs `rcvr_demo` and `rcvr_analog_display`. This program demonstrates simple command, control and analog application demonstrations. To see each demonstration, the user must load the appropriate receiver code examples:

`rcvr_demo.asm` and `rcvr_demo.hex`

When a push button on the transmitter module is depressed, the corresponding LED is lit on the PICKit 1 FLASH Starter Kit. Pressing the transmitter module push button GP3 lights LED D0 on the PICKit 1 Starter Kit. Pressing push button GP4 lights LED D1.

`rcvr_analog_display.asm` and `rcvr_analog_display.hex`

Pressing transmitter module push button GP3 lights LEDs D0-D7 on the PICKit Starter Kit with the upper 8-bit value read from the transmitter module 10-bit A/D channel 0 connected to potentiometer GP0. Pressing push button GP4 lights LEDs D0-D7 with the upper 8-bit value read from A/D channel 1 connected to potentiometer GP1.

The protocol is a simplified KEELOQ® protocol compatible with the HCS101 fixed code products. This receive code was adapted from Microchip Technology application note AN740.

The 10-bit analog value is placed into the 16-bit counter field of the simplified KEELOQ protocol.

2.5 RCVR_DEMO

This program demonstrates a simple command and control application. When a push button on the transmitter module is depressed, the corresponding LED is lit on the PICKit 1 FLASH Starter Kit.

Pressing transmitter module push button GP3 lights LED D0 on the PICKit 1. Pressing push button GP4 lights LED D1.

The protocol is a simplified KEELOQ protocol compatible with the HCS101 fixed code products. This receive code was adapted from Microchip Technology application note AN740.

2.6 RCVR_ANALOG_DISPLAY

This program demonstrates a simple analog display application. When a push button on the transmitter module is depressed, the corresponding LED is lit on the PICKit 1 FLASH Starter Kit.

Pressing transmitter module push button GP3 lights LEDs D0-D7 on the PICKit Starter Kit with the upper 8-bit value read from the transmitter module 10-bit A/D channel 0 connected to potentiometer GP0. Pressing push button GP4 lights LEDs D0-D7 with the upper 8-bit value read from A/D channel 1 connected to potentiometer GP1.

The protocol is a simplified KEELOQ protocol compatible with the HCS101 fixed code products. This receive code was adapted from Microchip Technology application note AN740.

The 10-bit analog value is placed into the 16-bit counter field of the simplified KEELOQ protocol.

2.7 XMIT_TEST

This program implements two tests that can be used to verify RF performance of the rfPIC Development Kit transmitter modules using a spectrum analyzer and calibrated antenna. The tests start when the indicated push button is pressed and stop when the push button is released. The processor sleeps between tests to conserve battery power.

2.7.1 Peak Power Measurement

Press push button GP3 (SW2). This test generates a constant unmodulated output for measuring peak output power. This test can be used for regulatory pre-compliance testing and antenna tuning.

2.7.2 Data Modulation and Bandwidth Measurement

Set potentiometer GP0 in one of four quarter positions to choose maximum, high, medium, or low speed signal rate. Then press GP4 (SW1) and fine adjust potentiometer GP1 for the desired signal rate. The signal is a square wave and does not exactly match the PWM or Manchester spectrums, but is quite useful to determine system performance. Table 2-1 demonstrates the approximate signal rates. Note that increasing the analog voltage decreases the signal rate and that the NRZ bps is double the modulation frequency.

TABLE 2-1: APPROXIMATE SIGNAL RATES

GP0	NRZ bps (0-100% GP1)	NRZ Pulse Width (0-100% GP1)
0-25%	52.6-3.64 kbps	19-274 μ sec
25-50%	3.64-1.88 kbps	275-530 μ sec
50-75%	1.88-1.27 kbps	531-786 μ sec
75-100%	1.27-0.96 kbps	787-1042 μ sec

2.8 PRESENTATION PAL

The Presentation Pal application turns your rfPIC Development Kit 1 into a wireless slide show presentation helper. By pressing the push-buttons on the transmitter module, the commands are converted to page-up and page-down keyboard commands for a personal computer. There are two programs required for this application.

2.8.1 USB Firmware - pres_pal.hex

Step 1:

The first step in converting your rfPIC Development Kit 1 is to program a blank PIC16C745 8-bit CMOS microcontroller with USB (not included with the rfPIC Development Kit) with `pres_pal.hex`. The PIC16C745 is a one time programmable (OTP) microcontroller and can be programmed on a PICSTART[®] Plus or PRO MATE[®] II programmer.

Step 2:

Remove the PICKit 1 FLASH Kit programmed PIC16C745 from socket U1. Insert the PIC16C745 programmed with `pres_pal.hex` into socket U1.

Step 3:

Remove the PIC12F675 microcontroller from the evaluation socket. Insert a wire jumper between pins 9 and 13.

Step 4:

When the PICkit Starter Kit is plugged into the personal computer USB jack, the program will enumerate as a keyboard.

Button presses on the transmitter module are interpreted as page-down, page-up and Alt-Tab keyboard commands. Page-down advances the slide. Page-up goes backwards in the slide presentation. When both buttons are pressed, Alt-Tab alternates between active programs.

2.8.2 Transmitter Firmware - `prespal_xmit.hex`

This program sends button press commands to the receiver. The button press commands are interpreted and sent to the personal computer as page-down and page-up commands to advance or retreat the slide presentation running on the computer.

This program is a slightly modified version of `xmit_demo.asm`. This program sends a different count value for each push button press. This allows the receiver to delay advancing the slide if the push button is pressed for an extended period of time. The receiver will delay advancing a few seconds if the push button is continuously pressed. This is similar to the key press auto-repeat feature of many personal computer keyboards.

2.9 PROGRAMMING TEMPLATES

Thoroughly commented templates are provided to assist the programmer in getting started with new projects. Two templates are provided:

`PIC12F629-675 Assembly Language Programming Template.asm`

Use this template to program the PIC12F629 or PIC12F675 8-pin FLASH PICmicro® MCU or the rfPIC12F675K/675F/675H PICmicro MCU with UHF ASK/FSK transmitter devices.

`PIC16F630-676 Assembly Language Programming Template.asm`

Use this template to program the PIC16F630 or PIC16F676 14-pin FLASH PICmicro microcontroller.

Chapter 3. rfRXD0420 Receiver Module

3.1 INTRODUCTION

The rfRXD0420 Receiver Module (see Figure 3-1) is a low cost, high performance UHF short-range radio ASK receiver design using the Microchip Technology rfRXD0420. The module design is suitable for:

- Wireless remote command and control
- Remote Keyless Entry (RKE)
- Security systems
- Low power telemetry applications

The specifics of the receiver module design are:

- Single channel, fixed frequency at 315 MHz and 433.92 MHz
- ASK modulation
- Signal rate: 4800 baud

Schematics, PCB layout and Bill-of-Materials (BOM) are provided in the following sections. Gerber files are available on the rfPIC™ Development Kit 1 CD-ROM.

The receiver module can be purchased separately or in packs of 5. See Table 3-1

TABLE 3-1: RECEIVER MODULE ORDERING INFORMATION

Frequency	Order Number	
	Single	5 Pack
315 MHz	AC164104	AC164106
433.92 MHz	AC164103	AC164105

3.2 HIGHLIGHTS

This chapter discusses:

- rfRXD0420 Receiver Module Description
- rfRXD0420 Receiver Module Schematic
- PCB Layout
- Gerber Files
- Bill-of-Materials
- Third Party Component Suppliers

3.3 rfRXD0420 DESCRIPTION

The rfRXD0420 is a stand-alone receiver module that can be used in a variety of ways.

- It can be plugged into the PICKit 1 FLASH Starter Kit expansion header J3 for demonstration and development.
- The receiver module can be installed in any project for proof-of-concept, demonstration, or development purposes. Once project proof-of-concept and demonstration have been proven, the designer can use the available Gerber files or complete a design of their own.

A detailed description of the rfRXD0420 UHF ASK/FSK/FM receiver is provided in the data sheet, DS70090.

A detailed description of the rfRXD0420 receiver module design is provided in application note, AN860.

FIGURE 3-1: rfRXD0420 RECEIVER MODULE

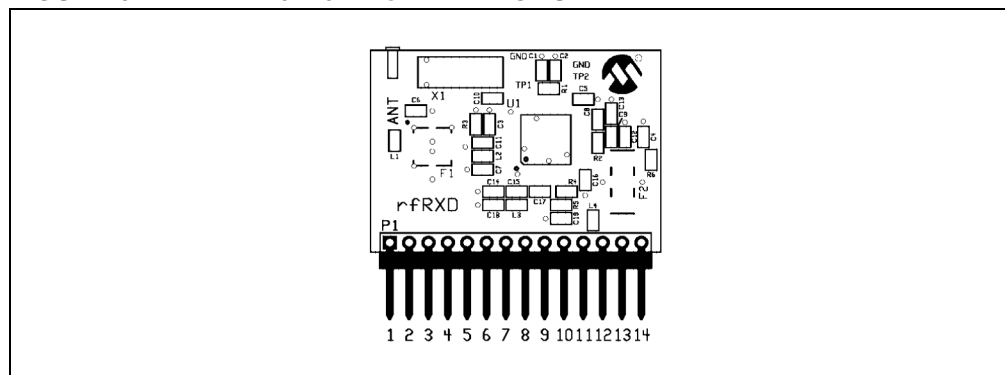

Table 3-2 lists the pinout for the rfRXD0420 receiver Module.

TABLE 3-2: rfRXD0420 RECEIVER MODULE PINOUT

Pin	Description
1-10	No Connection
11	Receive Data In
12	No Connection
13	Power: 2.5-5.5 VDC
14	Ground
ANT	Antenna Connection

The antenna connection is a 0.055 inch pin receptical. A simple small diameter wire (AWG 24) antenna can be constructed and inserted into the receptical. The length of the antenna wire depends on the frequency.

$$\lambda \text{ (meters)} = c / f \text{ (Hertz)}$$

where

$$c = 3 \times 10^8 = \text{speed of light (meters per second)}$$

$$f = \text{receive frequency (Hertz)}$$

$$\lambda = \text{wavelength (meters)}$$

The length of the antenna wire in inches can be found for a given frequency using the following formula:

$$\text{wire antenna length (inches)} = 2952.8 / f \text{ (MHz)}$$

Alternatively, the pin receptical can be removed and an alternate antenna connection can be made. For example, a coaxial wire can be connected to the antenna pad on the front side of the PCB and ground pad on the back side of the PCB.

3.4 rfRXD0420 SCHEMATIC

Figure 3-2 is a detailed schematic of the rfRXD0420 module.

FIGURE 3-2: rfRXD0420 RECEIVER MODULE

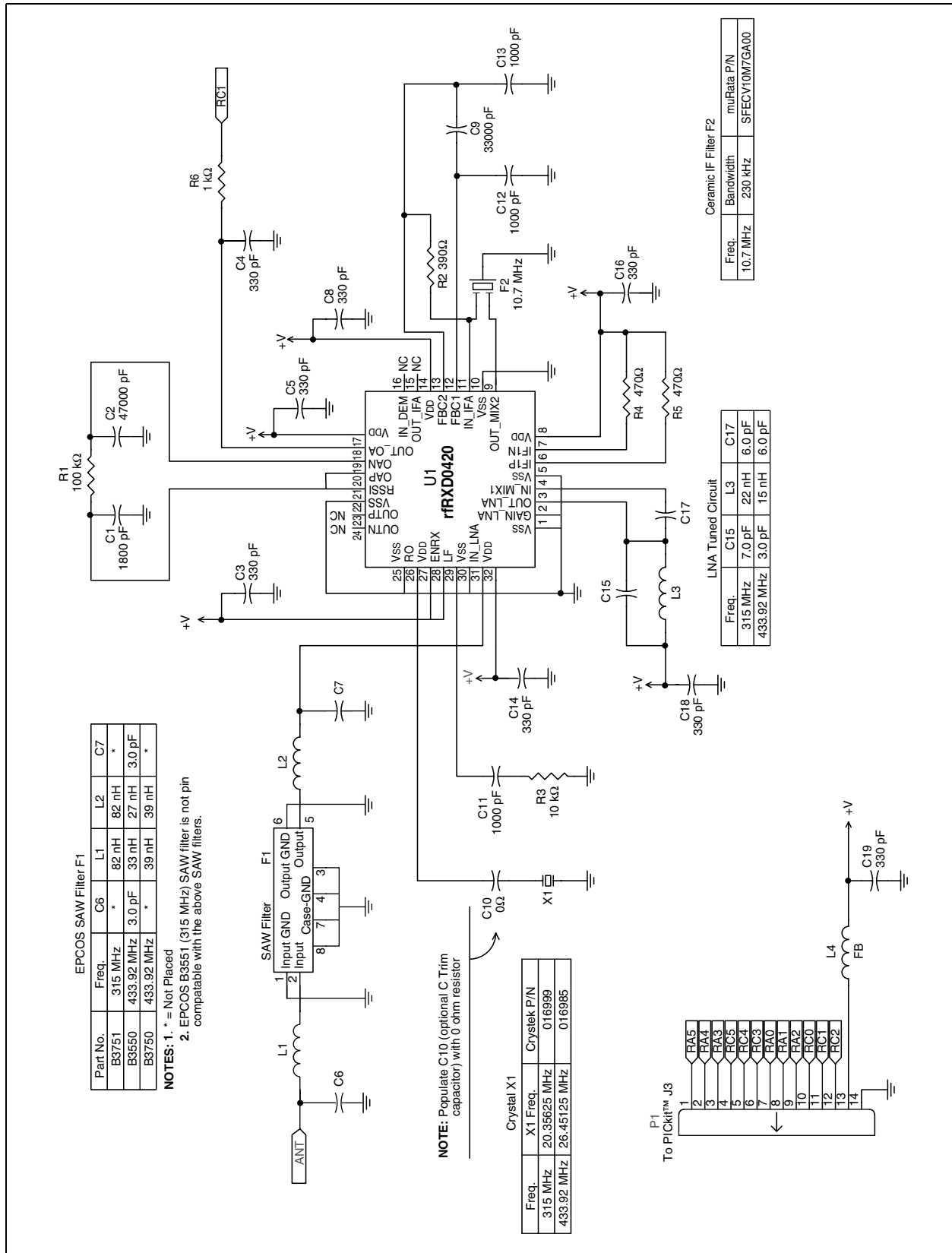

rfPIC™ Development Kit 1 User's Guide

3.5 PCB LAYOUT

The following figures illustrate the various layers of the rFRXD0420 receiver module printed circuit board.

FIGURE 3-3: rFRXD0420 TOP SILK-SCREEN

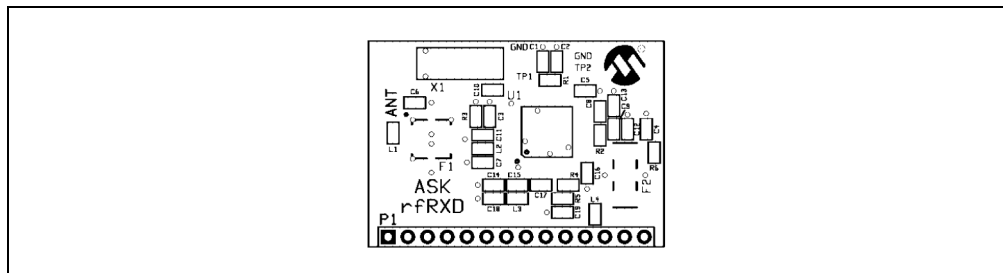

FIGURE 3-4: rFRXD0420 TOP COPPER

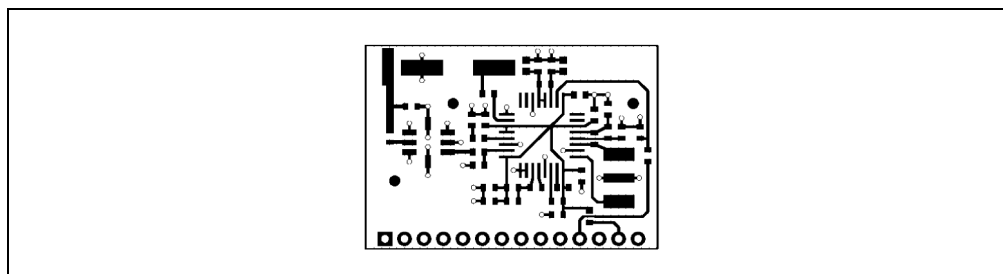
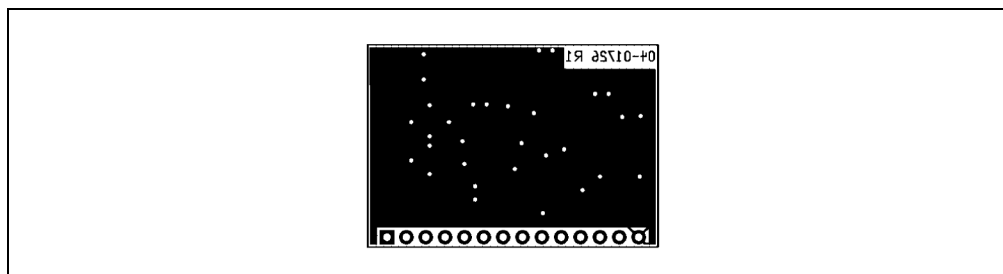

FIGURE 3-5: rFRXD0420 BOTTOM COPPER



3.6 GERBER FILES

Gerber Files for the rFRXD0420 are available on the rfPIC Development Kit 1 CD-ROM.

3.7 rfRXD0420 RECEIVER MODULE BILL-OF-MATERIALS

rfRXD0420 Receiver Module Bill-of-Materials						
Quantity	Designator	Value	Description	Order From	Part Number	
2	C6, C7	Not Placed				
1	C15 - 433.92 MHz	3 pF, NP0, 0603	Capacitor, Ceramic Chip	Digi-Key	PCC030CVTR-ND	
1	C17	6 pF, NP0, 0603	Capacitor, Ceramic Chip	Digi-Key	PCC060CVTR-ND	
1	C15 - 315 MHz	7 pF, NP0, 0603	Capacitor, Ceramic Chip	Digi-Key	PCC070CVTR-ND	
8	C3, C4, C5, C8, C14, C16, C18, C19	330 pF, X7R, 0603	Capacitor, Ceramic Chip	Digi-Key	PCC331ACVTR-ND	
3	C11, C12, C13	1000 pF, X7R, 0603	Capacitor, Ceramic Chip	Digi-Key	PCC1772TR-ND	
1	C1	1800 pF, X7R, 0603	Capacitor, Ceramic Chip	Digi-Key	PCC1775TR-ND	
1	C9	33000 pF, X7R, 0603	Capacitor, Ceramic Chip	Digi-Key	PCC1769TR-ND	
1	C2	47000 pF, X7R, 0603	Capacitor, Ceramic Chip	Digi-Key	PCC1771TR-ND	
1	C10	0 ohm, 0603	Resistor, Chip, Thick Film	Digi-Key	P0.0GTR-ND	
1	R2	390 ohm, 0603	Resistor, Chip, Thick Film	Digi-Key	P390GTR-ND	
2	R4, R5	470 ohm, 0603	Resistor, Chip, Thick Film	Digi-Key	P470GTR-ND	
1	R6	1K ohm	Resistor, Chip, Thick Film	Digi-Key	P1.0KGTR-ND	
1	R3	10K ohm, 0603	Resistor, Chip, Thick Film	Digi-Key	P10KGTR-ND	
1	R1	100K ohm, 0603	Resistor, Chip, Thick Film	Digi-Key	P100KGTR-ND	
1	L3 - 315 MHz	22 nH, 0603	Inductor, Chip	Digi-Key	TKS3715TR-ND	
1	L3 - 433.92 MHz	15 nH, 0603	Inductor, Chip	Digi-Key	TKS3713TR-ND	
2	L1, L2 - 315 MHz	82 nH, 0603	Inductor, Chip	Digi-Key	TKS3722TR-ND	
2	L1, L2 - 433.92 MHz	39 nH, 0603	Inductor, Chip	Digi-Key	TKS3718TR-ND	
1	L4	600Z, 0603	Ferrite Bead Chip	Digi-Key	240-1143-2-ND	
1	P1	14-Pin Right Angle Header	Single row 0.025" square right angle post	Digi-Key	A26510-ND	
1	F1 - 315 MHz		SAW Filter - 315 MHz	EPCOS	B3751	
1	F1 - 433.92 MHz		SAW Filter - 433.92 MHz	EPCOS	B3750	
1	F2		10.7 MHz Ceramic Filter, 230 kHz BW	muRata	SFECV10M7GA00	
1	X1 - 315 MHz	20.35625 MHz	Crystal, HC-49/S	Crystek	016999	
1	X1 - 433.92 MHz	26.451250 MHz	Crystal, HC-49/S	Crystek	016985	
1	U1	rfRXD0420	UHF ASK/FSK/FM Receiver	Microchip	rfRXD0420	

3.8 THIRD PARTY COMPONENT SUPPLIERS

Crystek Crystal Corporation

12730 Commonwealth Drive
Fort Myers, FL 33913
Toll Free: 1-800-237-3061
Phone: 1-239-561-3311
Fax: 1-239-561-1025
E-mail: salesdept@crystek.com
Internet: <http://www.crystek.com>

EPCOS, Inc.

186 Wood Avenue South
Iselin, NJ 08830
Phone: 1-732-906-4300
Fax: 1-732-603-5935
E-Mail: sales.usa@epcos.com
Internet: <http://www.usa.epcos.com>

Murata Electronics North America, Inc.

Corporate Headquarters
2200 Lake Park Drive
Smyrna, GA 30080-7604
Phone: 1-770-436-1300
Fax: 1-770-436-3030
Internet: <http://www.murata-northamerica.com>

Chapter 4. rfPIC12F675 Transmitter Module

4.1 INTRODUCTION

The rfPIC12F675 is a low cost, high performance UHF short-range radio ASK transmitter design using Microchip's rfPIC12F675K for 315 MHz and rfPIC12F675F for 433.92 MHz. The module design is suitable for:

- Wireless remote command and control
- Remote Keyless Entry (RKE)
- Security systems
- Low power telemetry applications

A schematic of the rfPIC12F675 module, PCB layout, and Bill-of-Materials (BOM) are provided in the following sections. Gerber files are available on the rfPIC™ Development Kit CD-ROM.

The transmitter modules can be ordered separately. See Table 4-1

TABLE 4-1: TRANSMITTER MODULE ORDERING INFORMATION

Frequency	Order Number
315 MHz	AC164102
433.92 MHz	AC164103

4.2 HIGHLIGHTS

This chapter discusses:

- rfPIC12F675 Transmitter Module Description
- rfPIC12F675 Transmitter Module Schematic
- PCB Layout
- Gerber Files
- Bill of Materials
- Third Party Component Suppliers

4.3 rfPIC12F675 DESCRIPTION

The rfPIC12F675 (Figure 4-1) is a stand-alone transmitter module that can be used in a variety of ways. As designed for the rfPIC Development Kit 1, the transmitter module demonstrates many features of the rfPIC12F675 transmitter device. The transmitter module contains:

- 2 push-button switches connected to GP3 and GP4
- 2 potentiometers connected to GP0 and GP1
- RF enable (RFENIN) connected to GP5
- Data ASK (DATAASK) connected to GP2
- Optional 8-pin socket (U2) for In-Circuit Emulation (ICE) or inserting an 8-pin DIP package version of the PIC12F675.

4.3.1 Power Requirements

Pwr Sel jumper P1 selects one of two power sources for the rfPIC12F675:

- PICKit™ Starter Kit position (pins 1 and 2) – placing a jumper in the PICKit position allows the transmitter module to be powered from connector P2 pin 13. When the transmitter module is plugged in the PICKit expansion header J3, the transmitter module is powered from the PICKit Starter Kit.

Note: When programming the transmitter module in the PICKit Starter Kit, the Pwr Sel jumper P1 must be in the PICKit position (pins 1 and 2 jumpered).

- Batt position (pins 2 and 3) – placing a jumper in the batt position allows the transmitter model to be powered from the lithium coin cell battery. When powered from the battery, the transmitter module can be used in portable operation.

4.3.2 Programming the rfPIC12F675

The rfPIC12F675 can be programmed by the PICKit 1 FLASH Starter kit.

Step 1:

Remove the PIC16F676 or PIC12F676 from the PICKit Starter Kit Evaluation Socket.

Step 2:

Plug the transmitter module into the PICKit Starter Kit expansion header J3 (See Figure 4-2).

Step 3:

The internal PIC12F675 in the rfPIC device now becomes the target programming device. Operate the PICKit Starter Kit in accordance with the steps outlined in the PICKit™ 1 FLASH Starter Kit User's Guide.

The transmitter module can be removed for stand-alone operation. Remember to set the Pwr Sel jumper for each mode of operation (See Power Requirements section above).

Note: There will be some interaction with the LEDs on the PICKit Starter Kit and the rfPIC12F675. If the user desires, the LEDs can be removed from the circuit by clipping resistors R5, R6, R7, and R8.

4.3.3 Optional 8-pin Socket U2

Socket U2 is an unpopulated 8-pin DIP connection on the transmitter module. A user-provided 8-pin IC socket can be soldered in place.

To use socket U2, the user must disconnect the internal PIC12F675 PICmicro® microcontroller internal to the rfPIC12F675 device from the circuits on the module. This is done by cutting six PCB traces marked by silk-screened "x".

Socket U2 can be used for:

- In Circuit Emulation (ICE) with an MPLAB® ICE-2000 and ICD2.
- Inserting an 8-pin DIP version of the PIC12F675. The DIP PICmicro microcontroller can be programmed externally (such as a PICSTART® Plus or PRO MATE® II) or internally via the PICKit Starter Kit.

A detailed description of the rfPIC12F675K/675F/675H microcontroller with UHF ASK/FSK transmitter is provided in the data sheet, DS70091.

A detailed description of the rfPIC12F675K/675 transmitter module antenna design is provided in the application note, AN868.

rfPIC12F675 Transmitter Module

FIGURE 4-1: rfPIC12F675 TRANSMITTER MODULE

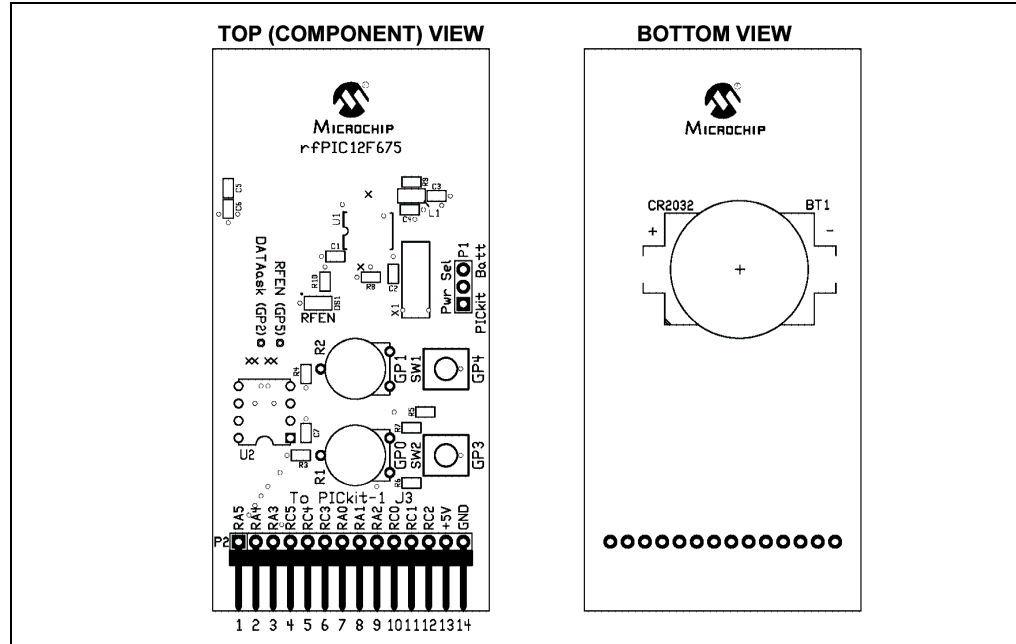
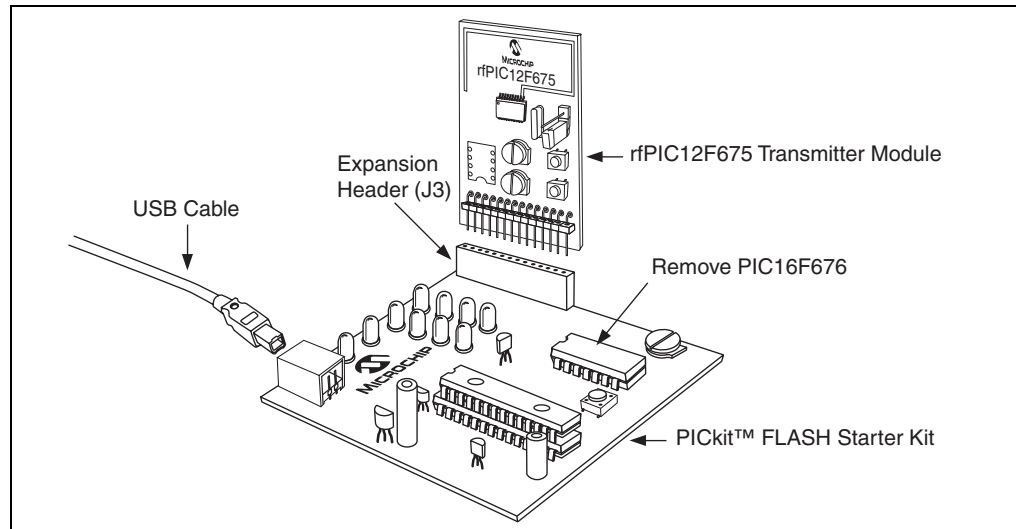

Table 4-2 lists the pinout associated with the rfPIC12F675 module.

TABLE 4-2: rfPIC12F675 TRANSMITTER MODULE PINOUT

Pin	Description
1	GP5
2	GP4
3	GP3
4, 5, 6	No Connection
7	GP0
8	GP1
9	GP2
10, 11, 12	No Connection
13	Power: 2.0-5.5 VDC
14	Ground

FIGURE 4-2: PROGRAMMING THE rfPIC12F675 TRANSMITTER MODULE IN THE PICKIT FLASH STARTER KIT



rfPIC™ Development Kit 1 User's Guide

4.4 rfPIC12F675 SCHEMATIC

FIGURE 4-3: rfPIC12F675 TRANSMITTER MODULE

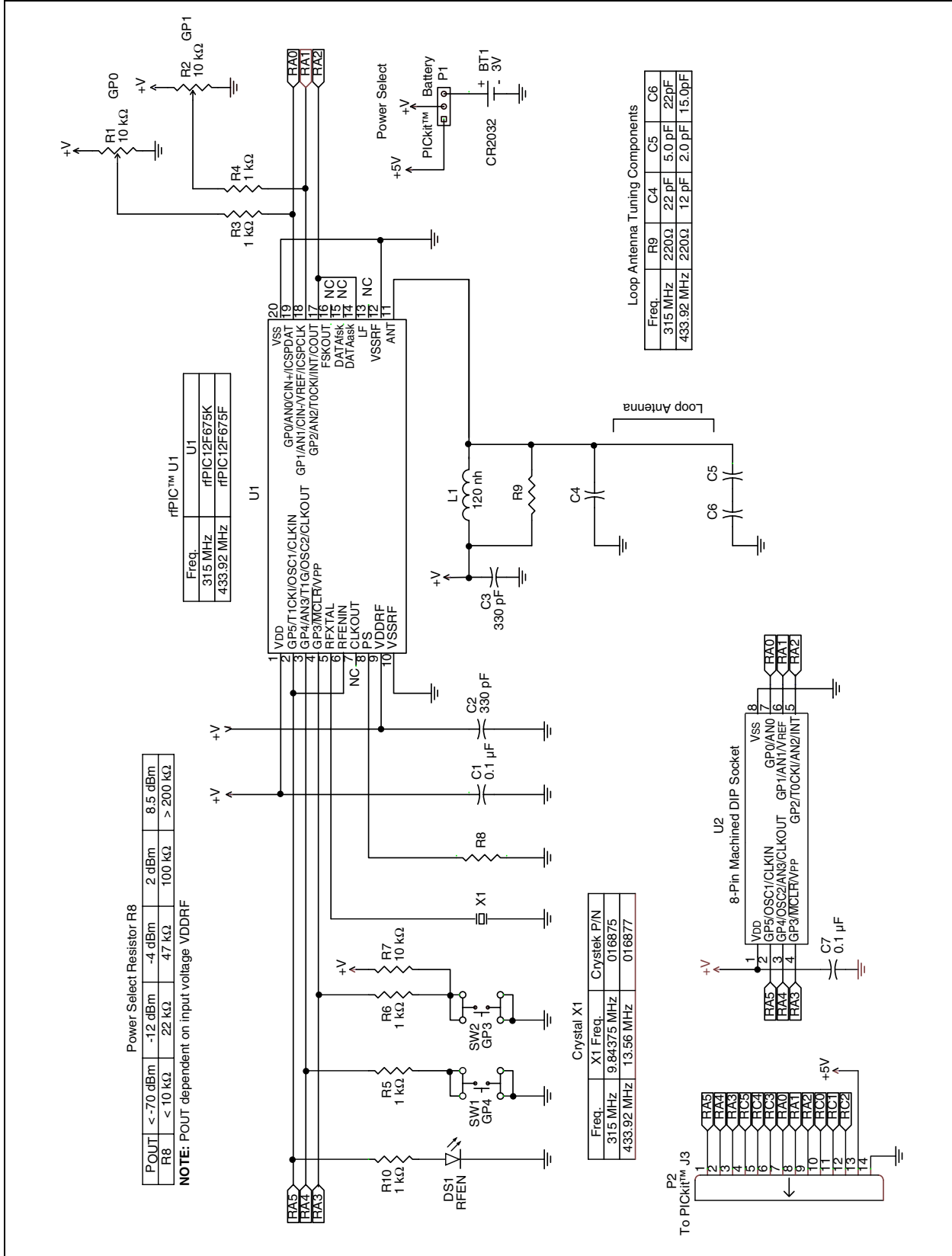

rfPIC12F675 Transmitter Module

4.5 PCB LAYOUT

The following diagrams show the various layers of the rfPIC12F675 transmitter module printed circuit board.

FIGURE 4-4: rfPIC12F675 TRANSMITTER MODULE TOP SILK-SCREEN

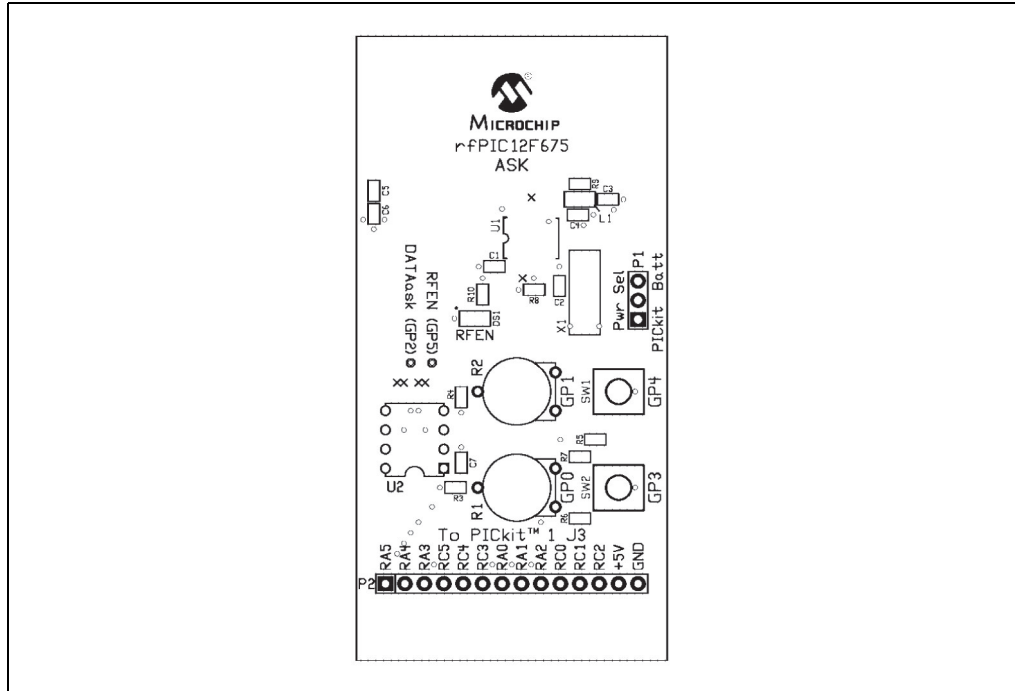

FIGURE 4-5: rfPIC12F675 TRANSMITTER MODULE TOP COPPER

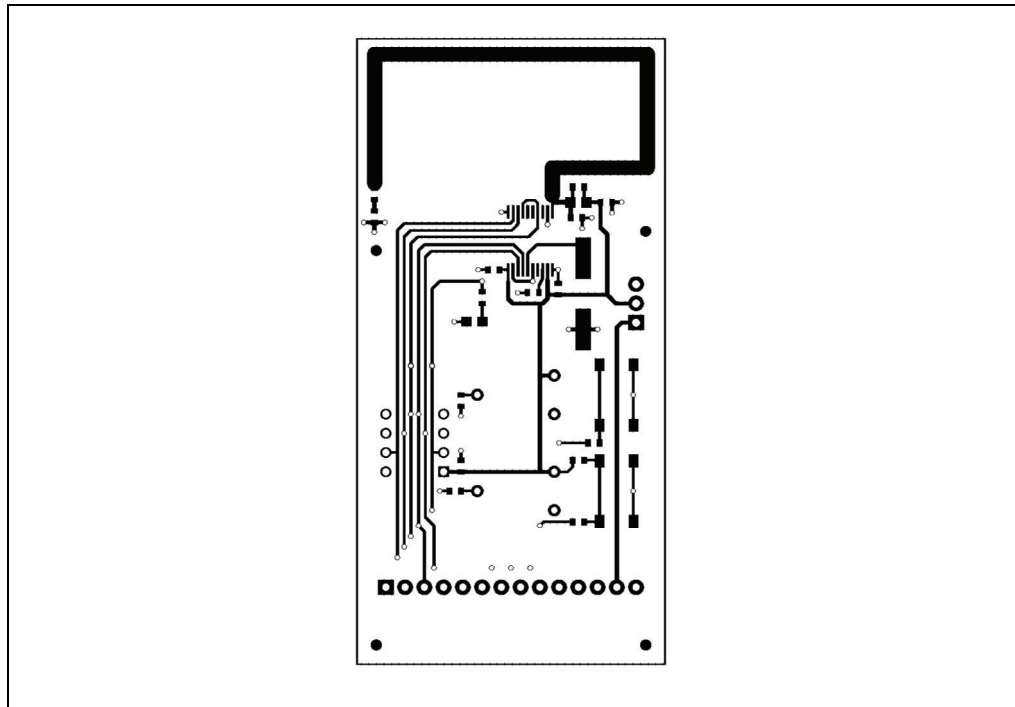
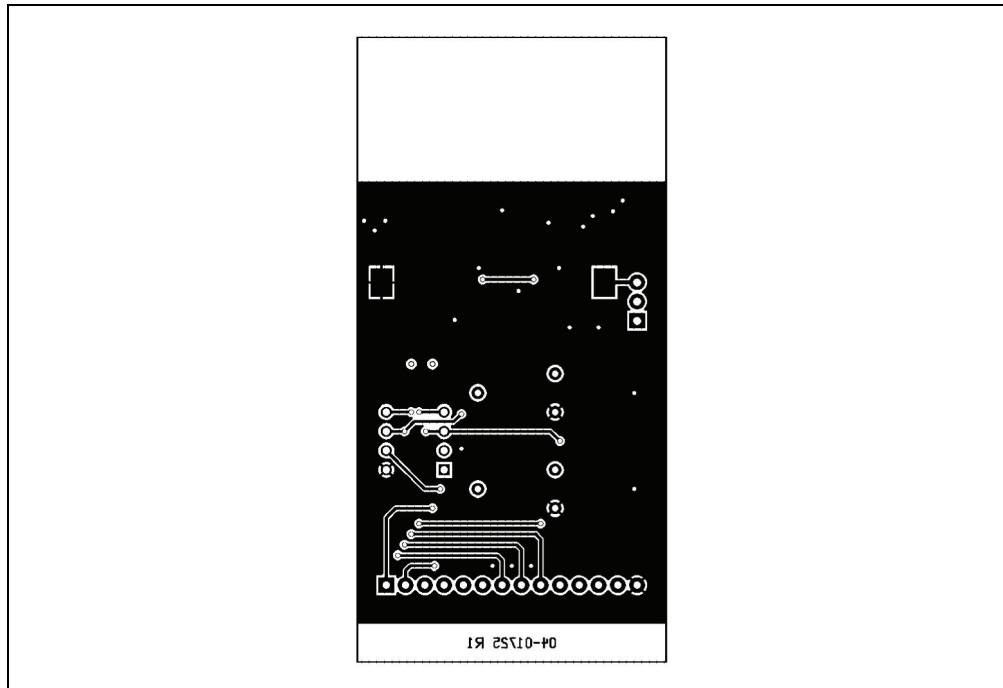

FIGURE 4-6: rfPIC12F675 TRANSMITTER MODULE BOTTOM COPPER



4.6 GERBER FILES

Gerber Files for the rfPIC12F675 transmitter module are available on the rfPIC Development Kit 1 CD-ROM.

rfPIC12F675 Transmitter Module

4.7 rfPIC12F675 TRANSMITTER MODULE BILL-OF-MATERIALS

rfPIC12F675 Transmitter Module Bill-of-Materials						
Quantity	Designator	Value	Description	Order From	Part Number	
1	C4 - 315 MHz	22 pF, NP0, 0603	Capacitor, Ceramic Chip	Digi-Key	PCC220ACVTR-ND	
1	C4 - 433.92 MHz	12 pF, NP0, 0603	Capacitor, Ceramic Chip	Digi-Key	PCC120ACVTR-ND	
1	C5 - 315 MHz	5.0 pF, NP0, 0603	Capacitor, Ceramic Chip	Digi-Key	PCC050CVTR-ND	
1	C5 - 433.92 MHz	2.0 pF, NP0, 0603	Capacitor, Ceramic Chip	Digi-Key	PCC020CVTR-ND	
1	C6 - 315 MHz	22 pF, NP0, 0604	Capacitor, Ceramic Chip	Digi-Key	PCC220ACVTR-ND	
1	C6 - 433.92 MHz	15 pF, NP0, 0604	Capacitor, Ceramic Chip	Digi-Key	PCC150ACVTR-ND	
2	C2, C3	330 pF, X7R, 0603	Capacitor, Ceramic Chip	Digi-Key	PCC331ACVTR-ND	
2	C1, C7	0.1 uF, X7R, 0603	Capacitor, Ceramic Chip	Digi-Key	PCC1762TR-ND	
1	R8	Not Populated				
2	R9	220 ohm, 0603	Resistor, Chip, Thick Film	Digi-Key	P220GTR-ND	
4	R3, R4, R5, R6, R10	1K ohm, 0603	Resistor, Chip, Thick Film	Digi-Key	P1.0KGT-ND	
1	R7	10K ohm, 0603	Resistor, Chip, Thick Film	Digi-Key	P10KGT-ND	
1	R1	220K ohm, 0603	Resistor, Chip, Thick Film	Digi-Key	P220KGT-ND	
2	R1, R2	10K ohm	Potentiometer	Digi-Key	3352E-103-ND	
1	DS1	SMT LED 0805		Digi-Key	67-1552-1-ND	
1	L1	120 nH, 0805	Inductor, Chip	Digi-Key	TKS2387CT-ND	
1	P1	3-pin header	Single row 0.025" square header	Digi-Key	S 1012-03-ND	
1	P2	14-Pin Right Angle Header	Single row 0.025" square right angle post	Digi-Key	A26510-ND	
1		2-pin shunt		Digi-Key	S9000-ND	
1	BT1	KS1060	Coin Cell Battery Holder	Digi-Key	1060KTR-ND	
1	Battery	CR2032	Lithium Cell Battery	Digi-Key	P189-ND	
2	SW1, SW2		Pushbutton switch	Digi-Key	SW415-ND	
1	X1 - 315 MHz	9.84375 MHz	Crystal, HC-49/S	Crystek	016875	
1	X1 - 433.92 MHz	13.56 MHz	Crystal, HC-49/S	Crystek	016877	
1	U1 - 315 MHz	rfPIC12F675K	Transmitter + PICmicro® MCU	Microchip	rfPIC12F675K	
1	U1 - 433.92 MHz	rfPIC12F675F	Transmitter + PICmicro® MCU	Microchip	rfPIC12F675F	
1	U2		8-pin machined socket	Digi-Key	ED3108-ND	

4.8 THIRD PARTY COMPONENT SUPPLIERS

Crystek Crystal Corporation

12730 Commonwealth Drive

Fort Myers, FL 33913

Toll Free: 1-800-237-3061

Phone: 1-239-561-3311

Fax: 1-239-561-1025

E-mail: salesdept@crystek.com

Internet: <http://www.crystek.com>

Chapter 5. Troubleshooting

5.1 INTRODUCTION

This chapter describes common problems associated with using the rfPIC Development Kit 1 and steps on how to resolve them.

For troubleshooting associated with the PICKit 1 FLASH Starter Kit, please refer to the Troubleshooting section of the PICKit™ 1 FLASH Starter Kit User's Guide, (DS40051).

5.2 FREQUENTLY ASKED QUESTIONS

5.2.1 Devices on the PICKit Starter Kit have no power?

Question:

I see the green POWER LED lit and the yellow BUSY LED extinguished, but there's no power to the rfPIC receiver or transmitter module. What is wrong?

Answer:

The green POWER LED tells you that there is power supplied to the PICKit Starter Kit from the USB cable and that the programming side of the PICKit Starter Kit is powered (the PIC16C745). The yellow BUSY LED tells you if power is being supplied to the device under test. Since you mentioned that the yellow BUSY LED is extinguished, this says that there is no power to the device under test.

Make sure that the DEVICE POWER checkbox (Figure 5-1) on the PICKit GUI is checked. This feature allows you to control the device under test power from the PICKit GUI.

FIGURE 5-1: DEVICE POWER CONTROL

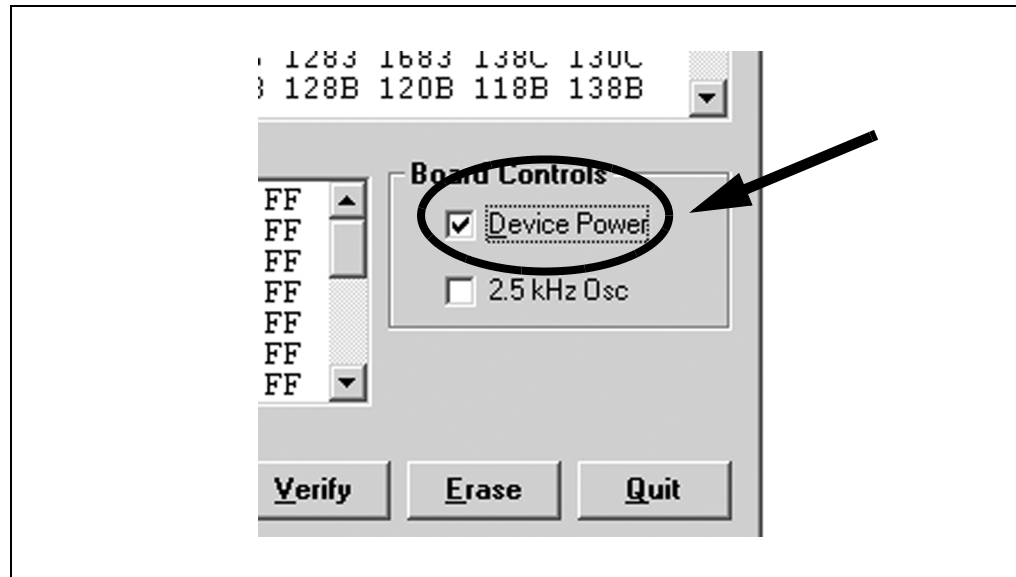

5.2.2 Programmer Not Found

Question:

When I disconnect and reconnect the USB cable, and I click on the WRITE DEVICE button, I receive a "Programmer not found" status message (see Figure 5-2).

Answer:

The PICkit GUI has lost communications with the PICkit Starter Kit. Simply click on the WRITE DEVICE button again and the GUI should re-establish communication with the PICkit Starter Kit.

If this condition persists, check that the PICkit Starter Kit is receiving power.

FIGURE 5-2: PROGRAMMER NOT FOUND STATUS MESSAGE



5.2.3 Insert Device

Question:

I am trying to program the transmitter module and I am getting an "Insert Device" status message (see Figure 5-3).

Answer:

Check that the Pwr Sel jumper on P1 is in the PICkit Starter Kit position (pins 1 and 2 jumpered).

FIGURE 5-3: INSERT DEVICE STATUS MESSAGE

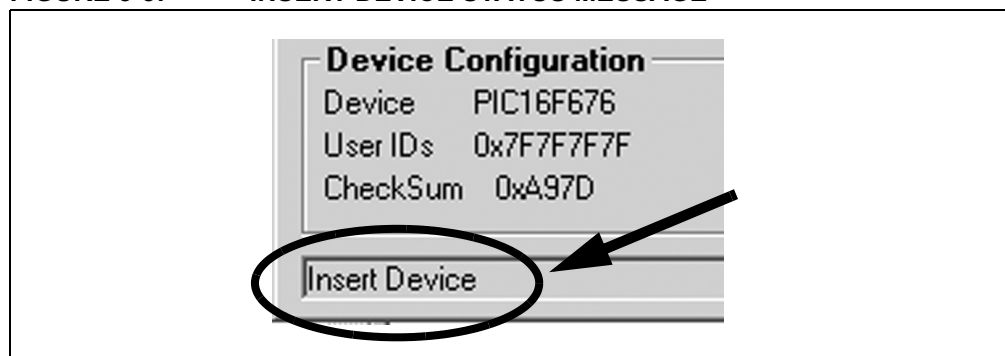

5.2.4 Checksum Verify Failed

Question:

I am trying to program the transmitter module and I am getting an “Checksum Verify Failed” status message (Figure 5-4).

Answer:

Check that the Pwr Sel jumper on P1 is in the PICkit Starter Kit position (pins 1 and 2 jumpered).

FIGURE 5-4: CHECKSUM VERIFY FAILED STATUS MESSAGE

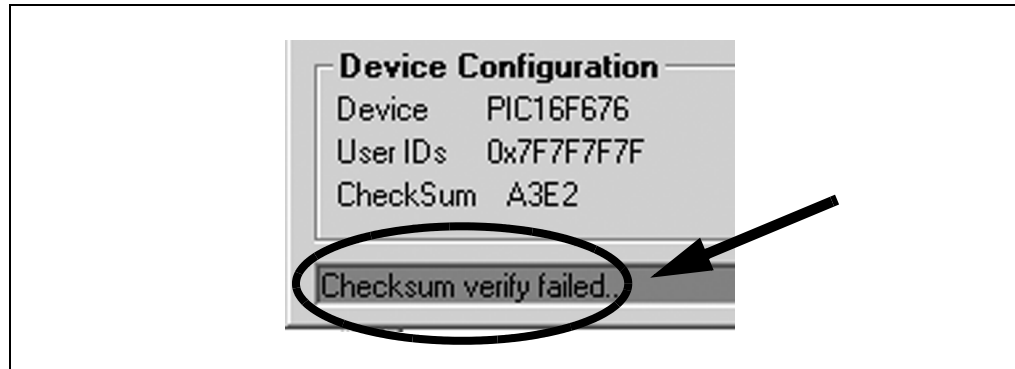

rfPIC™ Development Kit 1 User's Guide

NOTES:

NOTES:



WORLDWIDE SALES AND SERVICE

AMERICAS

Corporate Office

2355 West Chandler Blvd.
Chandler, AZ 85224-6199
Tel: 480-792-7200 Fax: 480-792-7277
Technical Support: 480-792-7627
Web Address: <http://www.microchip.com>

Atlanta

3780 Mansell Road, Suite 130
Alpharetta, GA 30022
Tel: 770-640-0034 Fax: 770-640-0307

Boston

2 Lan Drive, Suite 120
Westford, MA 01886
Tel: 978-692-3848 Fax: 978-692-3821

Chicago

333 Pierce Road, Suite 180
Itasca, IL 60143
Tel: 630-285-0071 Fax: 630-285-0075

Dallas

4570 Westgrove Drive, Suite 160
Addison, TX 75001
Tel: 972-818-7423 Fax: 972-818-2924

Detroit

Tri-Atria Office Building
32255 Northwestern Highway, Suite 190
Farmington Hills, MI 48334
Tel: 248-538-2250 Fax: 248-538-2260

Kokomo

2767 S. Albright Road
Kokomo, IN 46902
Tel: 765-864-8360 Fax: 765-864-8387

Los Angeles

18201 Von Karman, Suite 1090
Irvine, CA 92612
Tel: 949-263-1888 Fax: 949-263-1338

Phoenix

2355 West Chandler Blvd.
Chandler, AZ 85224-6199
Tel: 480-792-7966 Fax: 480-792-4338

San Jose

Microchip Technology Inc.
2107 North First Street, Suite 590
San Jose, CA 95131
Tel: 408-436-7950 Fax: 408-436-7955

Toronto

6285 Northam Drive, Suite 108
Mississauga, Ontario L4V 1X5, Canada
Tel: 905-673-0699 Fax: 905-673-6509

ASIA/PACIFIC

Australia

Microchip Technology Australia Pty Ltd
Marketing Support Division
Suite 22, 41 Rawson Street
Epping 2121, NSW
Australia
Tel: 61-2-9868-6733 Fax: 61-2-9868-6755

China - Beijing

Microchip Technology Consulting (Shanghai)
Co., Ltd., Beijing Liaison Office
Unit 915
Bei Hai Wan Tai Bldg.
No. 6 Chaoyangmen Beidajie
Beijing, 100027, No. China
Tel: 86-10-85282100 Fax: 86-10-85282104

China - Chengdu

Microchip Technology Consulting (Shanghai)
Co., Ltd., Chengdu Liaison Office
Rm. 2401-2402, 24th Floor,
Ming Xing Financial Tower
No. 88 TIDU Street
Chengdu 610016, China
Tel: 86-28-86766200 Fax: 86-28-86766599

China - Fuzhou

Microchip Technology Consulting (Shanghai)
Co., Ltd., Fuzhou Liaison Office
Unit 28F, World Trade Plaza
No. 71 Wusi Road
Fuzhou 350001, China
Tel: 86-591-7503506 Fax: 86-591-7503521

China - Hong Kong SAR

Microchip Technology Hongkong Ltd.
Unit 901-6, Tower 2, Metroplaza
223 Hing Fong Road
Kwai Fong, N.T., Hong Kong
Tel: 852-2401-1200 Fax: 852-2401-3431

China - Shanghai

Microchip Technology Consulting (Shanghai)
Co., Ltd.
Room 701, Bldg. B
Far East International Plaza
No. 317 Xian Xia Road
Shanghai, 200051
Tel: 86-21-6275-5700 Fax: 86-21-6275-5060

China - Shenzhen

Microchip Technology Consulting (Shanghai)
Co., Ltd., Shenzhen Liaison Office
Rm. 1812, 18/F, Building A, United Plaza
No. 5022 Binhe Road, Futian District
Shenzhen 518033, China
Tel: 86-755-82901380 Fax: 86-755-8295-1393

China - Qingdao

Rm. B505A, Fullhope Plaza,
No. 12 Hong Kong Central Rd.
Qingdao 266071, China
Tel: 86-532-5027355 Fax: 86-532-5027205

India

Microchip Technology Inc.
India Liaison Office
Marketing Support Division
Divyasree Chambers
1 Floor, Wing A (A3/A4)
No. 11, O'Shaughnessy Road
Bangalore, 560 025, India
Tel: 91-80-2290061 Fax: 91-80-2290062

Japan

Microchip Technology Japan K.K.
Benex S-1 6F
3-18-20, Shinyokohama
Kohoku-Ku, Yokohama-shi
Kanagawa, 222-0033, Japan
Tel: 81-45-471-6166 Fax: 81-45-471-6122

Korea

Microchip Technology Korea
168-1, Youngbo Bldg. 3 Floor
Samsung-Dong, Kangnam-Ku
Seoul, Korea 135-882
Tel: 82-2-554-7200 Fax: 82-2-558-5934

Singapore

Microchip Technology Singapore Pte Ltd.
200 Middle Road
#07-02 Prime Centre
Singapore, 188980
Tel: 65-6334-8870 Fax: 65-6334-8850

Taiwan

Microchip Technology (Barbados) Inc.,
Taiwan Branch
11F-3, No. 207
Tung Hua North Road
Taipei, 105, Taiwan
Tel: 886-2-2717-7175 Fax: 886-2-2545-0139

EUROPE

Austria

Microchip Technology Austria GmbH
Durisolstrasse 2
A-4600 Wels

Austria

Tel: 43-7242-2244-399
Fax: 43-7242-2244-393

Denmark

Microchip Technology Nordic ApS
Regus Business Centre
Lautrup høj 1-3
Ballerup DK-2750 Denmark
Tel: 45-4420-9895 Fax: 45-4420-9910

France

Microchip Technology SARL
Parc d'Activite du Moulin de Massy
43 Rue du Saule Trapu
Batiment A - Ier Etage
91300 Massy, France
Tel: 33-1-69-53-63-20 Fax: 33-1-69-30-90-79

Germany

Microchip Technology GmbH
Steinheilstrasse 10
D-85737 Ismaning, Germany
Tel: 49-89-627-144-0
Fax: 49-89-627-144-44

Italy

Microchip Technology SRL
Via Quasimodo, 12
20025 Legnano (MI)
Milan, Italy
Tel: 39-0331-742611 Fax: 39-0331-466781

United Kingdom

Microchip Ltd.
505 Eskdale Road
Wokingham
Wokingham
Berkshire, England RG41 5TU
Tel: 44-118-921-5869 Fax: 44-118-921-5820

05/30/03