

Evaluating the [AD7656/AD7657/AD7658](#), 250 kSPS, 6-Channel, Simultaneous Sampling, Bipolar 16-/14-/12-Bit ADCs

FEATURES

Full featured evaluation board for the [AD7656/AD7657/AD7658](#)

PC control in conjunction with the system demonstration platform ([EVAL-SDP-CB1Z](#))

PC software for control and data analysis (time and frequency domain)

Standalone capability

EVALUATION KIT CONTENTS

[EVAL-AD7656SDZ](#), [EVAL-AD7657SDZ](#), or [EVAL-AD7658SDZ](#) evaluation board

Evaluation software CD for the [AD7656/AD7657/AD7658](#)
9 V mains power supply adapter

ADDITIONAL EQUIPMENT NEEDED

[EVAL-SDP-CB1Z](#) system demonstration platform, includes a USB cable

Precision analog signal source

SMB cables

PC running Windows XP SP2, Windows Vista, or Windows 7 with USB 2.0 port

ONLINE RESOURCES

Documents

[AD7656/AD7657/AD7658](#) data sheet

[EVAL-AD7656SDZ/EVAL-AD7657SDZ/EVAL-AD7658SDZ](#) user guide

Required Software

[EVAL-AD7656SDZ/EVAL-AD7657SDZ/EVAL-AD7658SDZ](#) evaluation software

GENERAL DESCRIPTION

The [EVAL-AD7656SDZ/EVAL-AD7657SDZ/EVAL-AD7658SDZ](#) are full featured evaluation boards that can be used to easily evaluate all features of the [AD7656/AD7657/AD7658](#). The [AD7656/AD7657/AD7658](#) are 16-/14-/12-bit, 6-channel, 250 kSPS simultaneous sampling ADCs, respectively. Each part contains six 16-, 14-, or 12-bit, low power SAR ADCs and can operate from a single 4.75 V to 5.25 V power supply or dual ± 12 V power supplies. The parts feature throughput rates of up to 250 kSPS.

The evaluation boards can be controlled via the system demonstration platform (SDP). The [EVAL-SDP-CB1Z](#) board allows the evaluation boards to be controlled via the USB port of a PC using the [AD7656/AD7657/AD7658](#) evaluation software. The [EVAL-AD7656SDZ/EVAL-AD7657SDZ/EVAL-AD7658SDZ](#) generates all required power supplies on board and supplies power to the [EVAL-SDP-CB1Z](#) controller board.

On-board components include the following:

[AD8597](#): ultralow distortion, ultralow noise op amp (single)

[AD8031](#): 2.7 V, 800 μ A, 80 MHz rail-to-rail I/O single amplifier

[ADP1613](#): step-up PWM dc-to-dc switching converter

[ADP3303-5](#): high accuracy anyCAP[®] 200 mA low dropout linear regulator

[ADP2301](#): 1.2 A, 20 V, 1.4 MHz nonsynchronous step-down switching regulator

[ADM1185](#): quad voltage monitor and sequencer

[ADP190](#): logic controlled, high-side power switch

[ADG3308](#): low voltage, 1.15 V to 5.5 V, 8-channel bidirectional logic level translator

[ADR431](#): ultralow noise XFET[®] voltage reference with current sink and source capability

[AD780](#): 2.5 V/3.0 V ultrahigh precision band gap voltage reference

A functional block diagram is shown in Figure 1, and various link options are described in the Link Configuration Options section.

For full details on the [AD7656/AD7657/AD7658](#), see the [AD7656/AD7657/AD7658](#) data sheet, which should be consulted in conjunction with this user guide when using these evaluation boards.

TABLE OF CONTENTS

Features	1	Analog Inputs.....	14
Evaluation Kit Contents.....	1	Reference Options	14
Additional Equipment Needed	1	Sockets/Connectors	14
Online Resources	1	Modes of Operation	15
General Description	1	SDP Controlled Mode	15
Revision History	2	Standalone Mode.....	15
Functional Block Diagram	3	How to Use the Software for Evaluating the	
Getting Started	4	AD7656/AD7657/AD7658.....	16
Quick Start Steps	4	Setting Up the System for Data Capture	16
Software Installation Procedures.....	5	Overview of the Main Window.....	18
Evaluation Board Setup Procedures.....	8	Generating a Waveform Analysis Report.....	20
Evaluation Board Hardware.....	9	Generating a Histogram of the ADC Code Distribution	21
AD7656/AD7657/AD7658 Device Description.....	9	Generating a Fast Fourier Transform of AC Characteristics.....	22
Power Supplies	9	Generating a Summary of the Waveform, Histogram, and	
Link Configuration Options	10	Fast Fourier Transform.....	23
Setup Conditions	10	Related Links.....	24
Evaluation Board Circuitry	14		

REVISION HISTORY

7/13—Revision 0: Initial Version

FUNCTIONAL BLOCK DIAGRAM

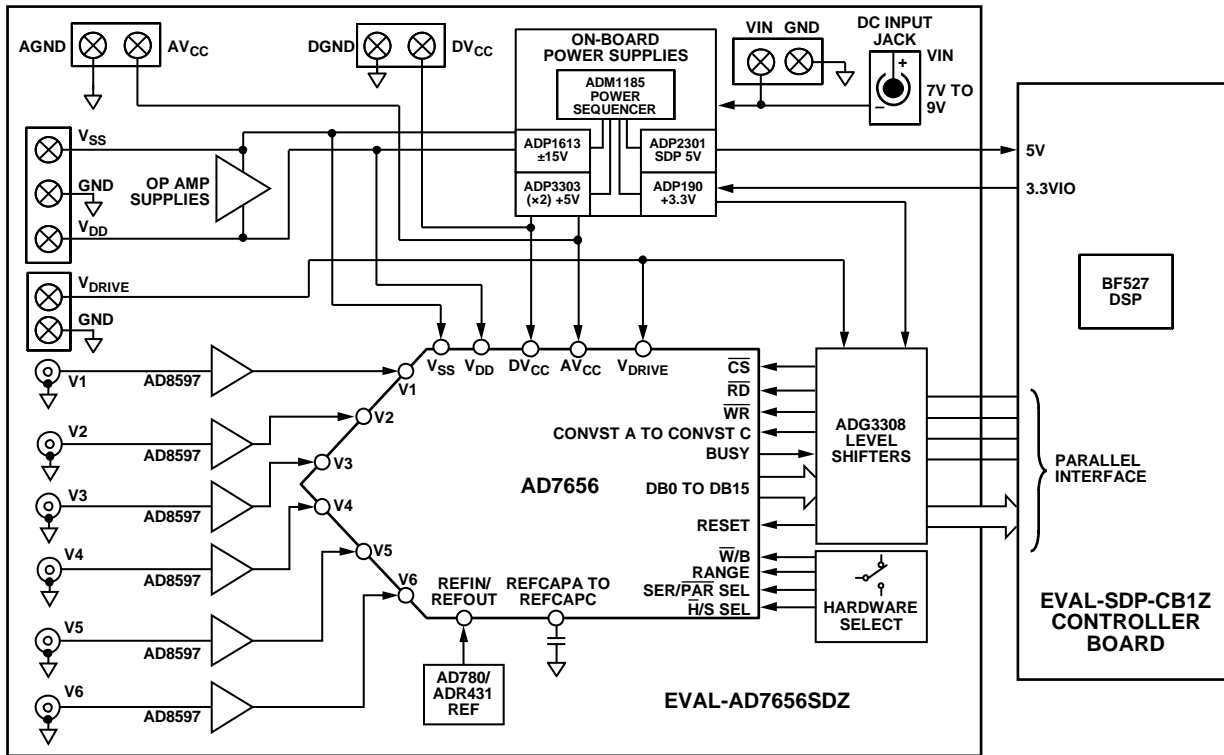

Figure 1.

11338-001

GETTING STARTED

QUICK START STEPS

To begin using the evaluation board, do the following:

1. With the [EVAL-SDP-CB1Z](#) board disconnected from the USB port of the PC, install the [AD7656/AD7657/AD7658](#) evaluation board software from the CD included in the evaluation board kit. The PC must be restarted after the software installation is complete. (For complete software installation instructions, see the Software Installation Procedures section.)
2. Connect the [EVAL-SDP-CB1Z](#) board to the [EVAL-AD7656SDZ/EVAL-AD7657SDZ/EVAL-AD7658SDZ](#) board as shown in Figure 2. Screw the two boards together using the nylon screw-nut set included in the evaluation
3. Connect the 9 V power supply adapter included in the evaluation board kit to Connector J702 on the [EVAL-AD7656SDZ/EVAL-AD7657SDZ/EVAL-AD7658SDZ](#) board.
4. Connect the [EVAL-SDP-CB1Z](#) board to the PC using the supplied USB cable. (If you are using Windows® XP, you may need to search for the [EVAL-SDP-CB1Z](#) drivers. Choose to automatically search for the drivers for the [EVAL-SDP-CB1Z](#) board if prompted by the operating system.)
5. Launch the [EVAL-AD7656SDZ/EVAL-AD7657SDZ/EVAL-AD7658SDZ](#) software from the **Analog Devices** subfolder in the **Programs** menu.

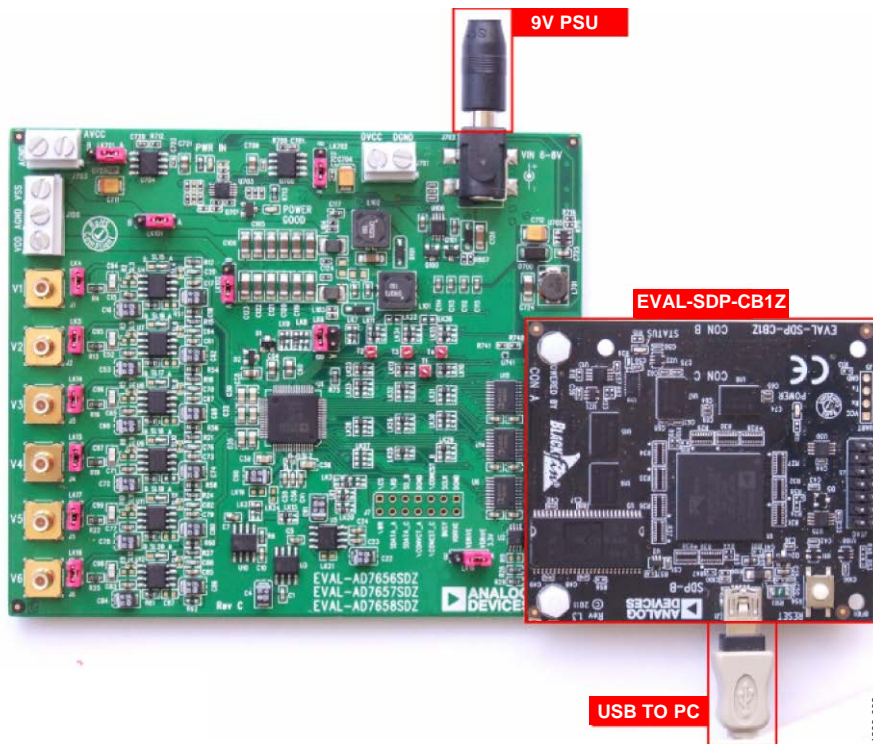

Figure 2. Hardware Configuration—Setting Up the [EVAL-AD7656SDZ/EVAL-AD7657SDZ/EVAL-AD7658SDZ](#) ([EVAL-AD7656SDZ/EVAL-AD7657SDZ/EVAL-AD7658SDZ](#) on Left and [EVAL-SDP-CB1Z](#) on Right)

SOFTWARE INSTALLATION PROCEDURES

The EVAL-AD7656SDZ/EVAL-AD7657SDZ/EVAL-AD7658SDZ evaluation kit includes a CD containing software to be installed on your PC before you begin using the evaluation board.

There are two parts to the installation:

- AD7656/AD7657/AD7658 evaluation board software installation
- EVAL-SDP-CB1Z system demonstration platform board drivers installation

Warning

The evaluation board software and drivers must be installed before connecting the evaluation board and EVAL-SDP-CB1Z board to the USB port of the PC to ensure that the evaluation system is correctly recognized when it is connected to the PC.

Installing the AD7656/AD7657/AD7658 Evaluation Board Software

To install the AD7656/AD7657/AD7658 evaluation board software,

1. With the EVAL-SDP-CB1Z board disconnected from the USB port of the PC, insert the installation CD into the CD-ROM drive.
2. Double-click the **setup.exe** file to begin the evaluation board software installation. The software is installed to the following default location: **C:\Program Files\Analog Devices\AD7656_57_58**.
3. A dialog box appears asking for permission to allow the program to make changes to your computer. Click **Yes**.

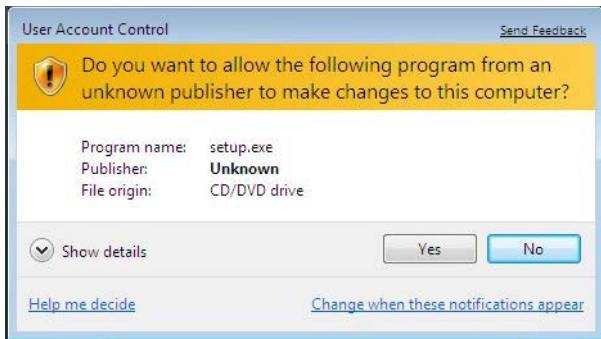

Figure 3. AD7656/AD7657/AD7658 Evaluation Board Software Installation: Granting Permission for Program to Make Changes

4. Select the location to install the software, and then click **Next**.

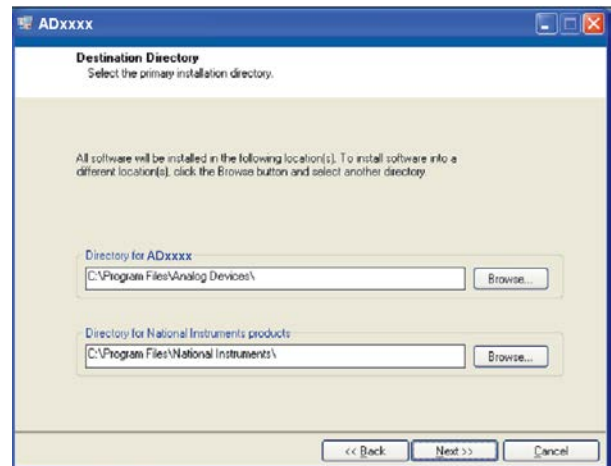

Figure 4. AD7656/AD7657/AD7658 Evaluation Board Software Installation: Selecting the Location for Software Installation

5. A license agreement appears. Read the agreement, and then select **I accept the License Agreement** and click **Next**.



Figure 5. AD7656/AD7657/AD7658 Evaluation Board Software Installation: Accepting the License Agreement

6. A summary of the installation is displayed. Click **Next** to continue.

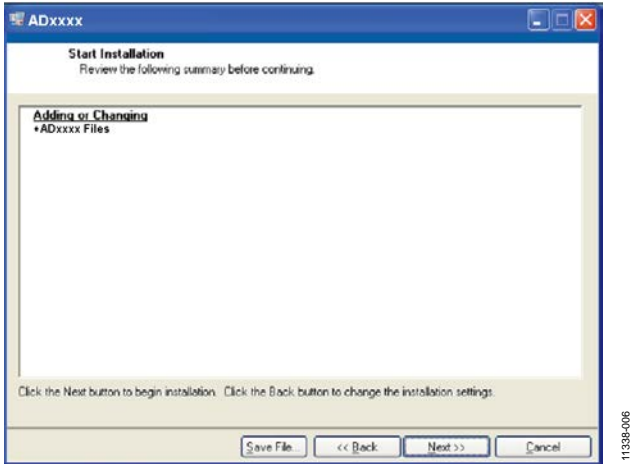

Figure 6. AD7656/AD7657/AD7658 Evaluation Board Software Installation: Reviewing a Summary of the Installation

7. A dialog box informs you when the installation is complete. Click **Next**.

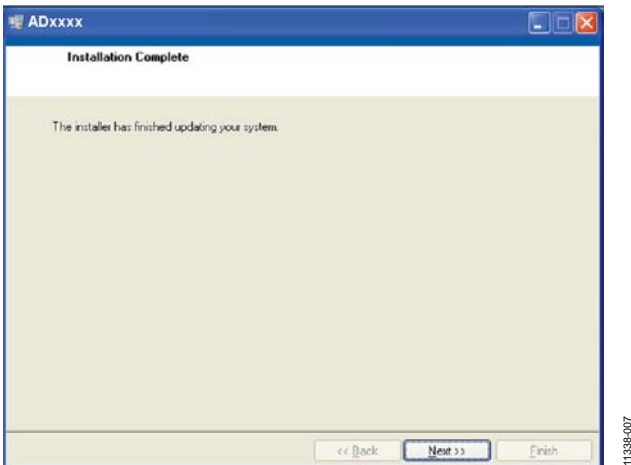

Figure 7. AD7656/AD7657/AD7658 Evaluation Board Software Installation: Indicating When the Installation Is Complete

Installing the EVAL-SDP-CB1Z System Demonstration Platform Board Drivers

After the installation of the evaluation board software is complete, a welcome window is displayed for the installation of the EVAL-SDP-CB1Z system demonstration platform board drivers.

1. With the EVAL-SDP-CB1Z board still disconnected from the USB port of the PC, make sure that all other applications are closed, and then click **Next**.



Figure 8. EVAL-SDP-CB1Z Drivers Setup: Beginning the Drivers Installation

2. Select the location to install the drivers, and then click **Next**.

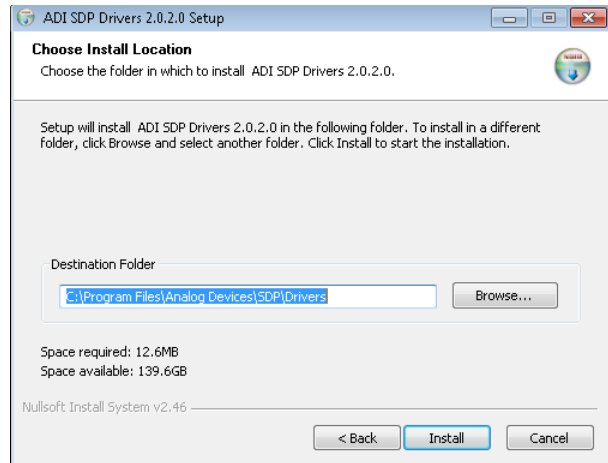

Figure 9. EVAL-SDP-CB1Z Drivers Setup: Selecting the Location for Drivers Installation

3. Click **Install** to confirm that you would like to install the drivers.

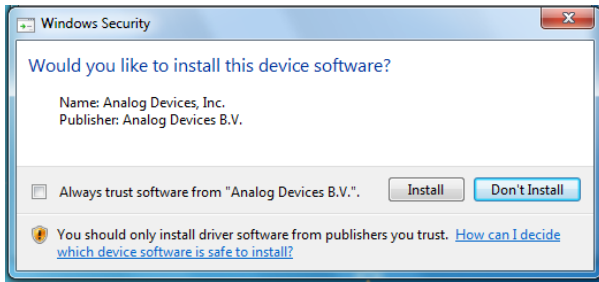

Figure 10. EVAL-SDP-CB1Z Drivers Setup: Granting Permission to Install Drivers

4. To complete the drivers installation, click **Finish**, which closes the installation wizard.

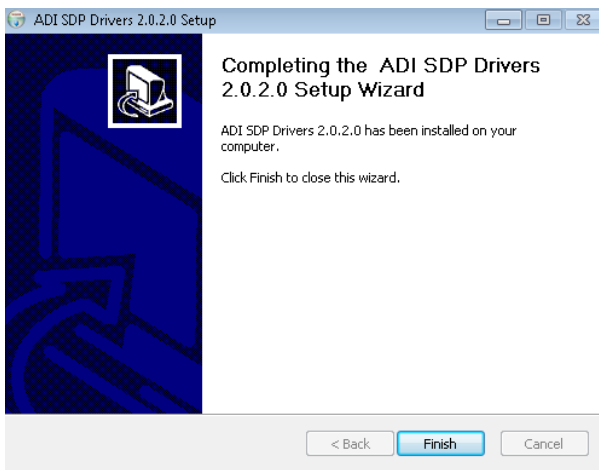

Figure 11. EVAL-SDP-CB1Z Drivers Setup: Completing the Drivers Setup Wizard

5. Before using the evaluation board, you must restart your computer. A dialog box opens, giving you the following options: **Restart**, **Shut Down**, **Restart Later**. Click the appropriate button.

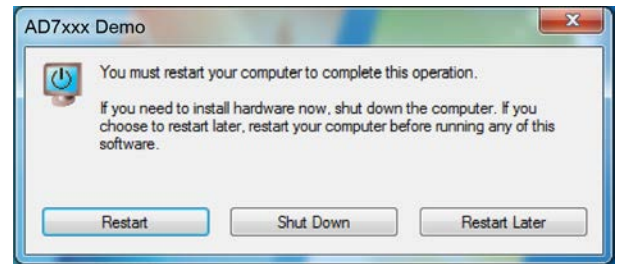

Figure 12. EVAL-SDP-CB1Z Drivers Setup: Restarting the Computer

11338-010

11338-012

11338-011

EVALUATION BOARD SETUP PROCEDURES

The [AD7656/AD7657/AD7658](#) evaluation board connects to the [EVAL-SDP-CB1Z](#) system demonstration board. The [EVAL-SDP-CB1Z](#) board is the controller board, which is the communication link between the PC and the main evaluation board. Figure 2 shows a photograph of the connections made between the [AD7656/AD7657/AD7658](#) daughter board and the [EVAL-SDP-CB1Z](#) board.

After following the instructions in the Software Installation Procedures section, set up the evaluation and SDP boards as detailed in this section.

Warning

The evaluation software and drivers must be installed before connecting the evaluation board and [EVAL-SDP-CB1Z](#) board to the USB port of the PC to ensure that the evaluation system is correctly recognized when it is connected to the PC.

Configuring the Evaluation and SDP Boards

1. Connect the [EVAL-AD7656SDZ/EVAL-AD7657SDZ/EVAL-AD7658SDZ](#) board to Connector A or Connector B of the [EVAL-SDP-CB1Z](#) board (see Figure 2).
 - a. Screw the two boards together using the nylon screw-nut set included in the evaluation board kit to ensure that the boards are connected firmly together.
2. Connect the 9 V power supply adapter included in the evaluation kit to Connector J702 of the [EVAL-AD7656SDZ/EVAL-AD7657SDZ/EVAL-AD7658SDZ](#) board. (See Table 1 for more information about the connections and options for the required power supplies.)
3. Connect the [EVAL-SDP-CB1Z](#) board to the PC using the supplied USB cable.

EVALUATION BOARD HARDWARE

AD7656/AD7657/AD7658 DEVICE DESCRIPTION

Each AD7656/AD7657/AD7658 device contains six 16-/14-/12-bit, fast, low power successive approximation ADCs in a package designed on the *i*CMOS[®] process (industrial CMOS). *i*CMOS is a process combining high voltage silicon with submicron CMOS and complementary bipolar technologies. It enables the development of a wide range of high performance analog ICs capable of 33 V operation in a footprint that no previous generation of high voltage parts could achieve.

There are also reduced decoupling pin- and software-compatible versions of these devices available: AD7656-1/AD7657-1/AD7658-1. Both versions feature throughput rates of up to 250 kSPS. For more information about these devices, refer to the AD7656/AD7657/AD7658 data sheet, which should be used in conjunction with this user guide (or refer to the AD7656-1/AD7657-1/AD7658-1 data sheet, which should be used in conjunction with the EVAL-AD7656-1SDZ/EVAL-AD7657-1SDZ/EVAL-AD7658-1SDZ user guide (UG-417)).

POWER SUPPLIES

The EVAL-AD7656SDZ/EVAL-AD7657SDZ/EVAL-AD7658SDZ can be used in two modes: SDP controlled mode and standalone mode (see the Modes of Operation section for more information).

When the EVAL-AD7656SDZ/EVAL-AD7657SDZ/EVAL-AD7658SDZ board is used in conjunction with the EVAL-SDP-CB1Z board (SDP controlled mode), connect the 9 V dc supply to Connector J702 on the EVAL-AD7656SDZ/EVAL-AD7657SDZ/EVAL-AD7658SDZ board. The V_{DD} , V_{SS} , AV_{CC} , and DV_{CC} supplies are generated on board. When the EVAL-AD7656SDZ/EVAL-AD7657SDZ/EVAL-AD7658SDZ board is used in standalone mode, the V_{DD} , V_{SS} , AV_{CC} , and DV_{CC} supplies must be sourced from external sources (see Table 1).

In SDP controlled mode and standalone mode, each supply is decoupled on the EVAL-AD7656SDZ/EVAL-AD7657SDZ/EVAL-AD7658SDZ using 10 μ F and 0.1 μ F capacitors. A single ground plane is used on this board to minimize the effect of high frequency noise interference.

Table 1. External Power Supplies Required

Power Supply	Connector	Voltage Range	Purpose
V_{IN} ¹	J702	7 V to 9 V	Supplies all on-board power supplies, generating all required voltages to run the evaluation board
V_{DD}	J100	+12 V to +16.5 V	Supplies the positive rail of the amplifier
V_{SS}	J100	-12 V to -16.5 V	Supplies the negative rail of the amplifier
AV_{CC}	J703	4.75 V to 5.25 V	Supplies the AV_{CC} analog supply on the ADC
DV_{CC}	J701	4.75 V to 5.25 V	Supplies the DV_{CC} digital supply on the ADC

¹ When V_{IN} is supplied, all other power supplies are available on board. If the V_{IN} supply is not used, all other power supplies must be sourced from an external source.

LINK CONFIGURATION OPTIONS

There are multiple jumper (LKx) and solder link (SLx) options that must be set correctly to select the appropriate operating setup before you begin using the evaluation board. The functions of these options are outlined in Table 2.

SETUP CONDITIONS

Care should be taken before applying power and signals to the evaluation board to ensure that all link positions are as required by the operating mode. There are two modes in which to operate

the evaluation board. The evaluation board can be operated in SDP controlled mode to be used with the SDP board, or the evaluation board can be used in standalone mode.

Table 3 shows the default positions in which the links are set when the evaluation board is packaged. When the board is shipped, it is assumed that you are going to operate the evaluation board with the SDP board (SDP controlled mode).

Table 2. Link Option Functions

Link No.	Function
LK1	H/S SEL selection. Position A: the software input is selected. Position B: the hardware input is selected.
LK2	V _{REF} buffer signal selection. Position A: the V _{REF} signal is unbuffered. Position B: the V _{REF} signal is buffered by the AD8031 op amp (U10).
LK3	$\overline{WR}/REF_{EN/DIS}$ signal selection. Position A: the $\overline{WR}/REF_{EN/DIS}$ pin is connected to EVAL-SDP-CB1Z. Position B: the $\overline{WR}/REF_{EN/DIS}$ pin is connected to the J7-2 external socket. Position C: the $\overline{WR}/REF_{EN/DIS}$ pin is connected to GND. Position D: the $\overline{WR}/REF_{EN/DIS}$ pin is connected to V _{DRIVE} .
LK4	V1 input jumper. Inserted: the V1 input is shorted to GND.
LK5	V2 input jumper. Inserted: the V2 input is shorted to GND.
LK6	RANGE signal selection. Position A: the RANGE pin is connected to V _{DRIVE} . Position B: the RANGE pin is connected to GND. The input range is set to $\pm 4 \times V_{REF}$.
LK7	\overline{STBY} signal selection. Position A: the \overline{STBY} pin is connected to V _{DRIVE} . Normal operation is selected. Position B: the \overline{STBY} pin is connected to GND.
LK8	RESET signal selection. Position A: the RESET pin is connected to V _{DRIVE} . Position B: the RESET pin is connected to GND. Position C: the RESET pin is connected to EVAL-SDP-CB1Z.
LK9	$\overline{W/B}$ signal selection. Position A: the $\overline{W/B}$ pin is connected to V _{DRIVE} . Position B: the $\overline{W/B}$ pin is connected to GND. Word mode is selected.
LK10	BUSY signal selection. Position A: the BUSY pin is connected to EVAL-SDP-CB1Z. Position B: the BUSY pin is connected to the J7-12 external socket.
LK11	CONVST A signal selection. Position A: the CONVST A pin is connected to the J7-8 external socket. Position B: the CONVST A pin is connected to EVAL-SDP-CB1Z. Position C: the CONVST A pin is connected to GND.
LK12	\overline{CS} source signal selection. Position A: the \overline{CS} pin is connected to EVAL-SDP-CB1Z. Position B: the \overline{CS} pin is connected to the J7-1 external socket.
LK13	REFIN/REFOUT source signal selection. Position A: the REFIN/REFOUT signal is sourced from AD780 (U5). Position B: the REFIN/REFOUT signal is sourced from ADR431 (U3).
LK14	V3 input jumper. Inserted: the V3 input is shorted to GND.

Link No.	Function
LK15	V4 input jumper. Inserted: the V4 input is shorted to GND.
LK16	V _{DRIVE} source signal selection. Position A: the V _{DRIVE} signal is sourced from the on-board 3.3 V supply. (Requires the EVAL-SDP-CB1Z board to be connected.) Position B: the V _{DRIVE} pin is connected to the J7-14 external socket.
LK17	V5 input jumper. Inserted: the V5 input is shorted to GND.
LK18	V6 input jumper. Inserted: the V6 input is shorted to GND.
LK19	REFIN/REFOUT input selection. Inserted: the V _{REF} signal is connected to the REFIN/REFOUT pin.
LK20	SER/ $\overline{\text{PAR SEL}}$ selection. Position A: the SER/ $\overline{\text{PAR SEL}}$ pin is connected to V _{DRIVE} . Position B: the SER/ $\overline{\text{PAR SEL}}$ pin is connected to GND. Parallel mode is selected.
LK21	AD780 (U5) voltage output selection. Inserted: the AD780 voltage output is 3 V. Removed: the AD780 voltage output is 2.5 V.
LK22	CONVST A/CONVST B link selection. Inserted: connects CONVST A to CONVST B.
LK23	$\overline{\text{RD}}$ source signal selection. Position A: the $\overline{\text{RD}}$ pin is connected to EVAL-SDP-CB1Z . Position B: the $\overline{\text{RD}}$ pin is connected to the J7-3 external socket.
LK24	REFCAPA source signal selection. Inserted: an external reference is connected to REFCAPA. Removed: an external reference is disconnected from REFCAPA.
LK25	DB10/DOUT C destination selection. Position A: data is sent to EVAL-SDP-CB1Z . Position B: data is sent to the J7-4 external socket.
LK26	DB7/HBEN/DCEN selection. Position A: data is sent to EVAL-SDP-CB1Z . Position B: the DB7/HBEN/DCEN pin is connected to V _{DRIVE} . Position C: the DB7/HBEN/DCEN pin is connected to GND.
LK27	DB9/DOUT B destination selection. Position A: data is sent to EVAL-SDP-CB1Z . Position B: not used. Position C: data is sent to the J7-5 external socket.
LK28	DB8/DOUT A destination selection. Position A: data is sent to EVAL-SDP-CB1Z . Position B: not used. Position C: data is sent to the J7-6 external socket.
LK29	DB14/REFBUF $\overline{\text{EN/DIS}}$ selection. Position A: data is sent to EVAL-SDP-CB1Z . Position B: the DB14/REFBUF $\overline{\text{EN/DIS}}$ pin is connected to V _{DRIVE} . Position C: the DB14/REFBUF $\overline{\text{EN/DIS}}$ pin is connected to GND.
LK30	DB6/SCLK selection. Position A: the DB6/SCLK pin is connected to EVAL-SDP-CB1Z . Position B: not used. Position C: the DB6/SCLK pin is connected to the J7-11 external socket.
LK31	DB2/SEL C selection. Position A: data is sent to EVAL-SDP-CB1Z . Position B: the DB2/SEL C pin is connected to V _{DRIVE} . Position C: the DB2/SEL C pin is connected to GND.
LK32	DB1/SEL B selection. Position A: data is sent to EVAL-SDP-CB1Z . Position B: the DB1/SEL B pin is connected to V _{DRIVE} . Position C: the DB1/SEL B pin is connected to GND.

Link No.	Function															
LK33	DB0/SEL A selection. Position A: data is sent to EVAL-SDP-CB1Z . Position B: the DB0/SEL A pin is connected to V _{DRIVE} . Position C: the DB0/SEL A pin is connected to GND.															
LK34	CONVST B selection. Position A: the CONVST B pin is connected to the J7-9 external socket. Position B: the CONVST B pin is connected to EVAL-SDP-CB1Z . Position C: the CONVST B pin is connected to GND.															
LK35	CONVST C selection. Position A: the CONVST C pin is connected to the J7-10 external socket. Position B: the CONVST C pin is connected to EVAL-SDP-CB1Z . Position C: the CONVST C pin is connected to GND.															
LK36	CONVST A/CONVST C link selection. Inserted: connects CONVST A to CONVST C.															
LK101	V _{SS} signal source selection (op amp negative supply). Position A: the V _{SS} signal is sourced from the on-board supply generation circuitry (–12 V). Position B: the V _{SS} signal is sourced from the J100 external socket.															
LK102	V _{DD} signal source selection (op amp positive supply). Position A: the V _{DD} signal is sourced from the on-board supply generation circuitry (+12 V). Position B: the V _{DD} signal is sourced from the J100 external socket.															
LK103 to LK106	Sets the V _{DD} and V _{SS} levels when using the on-board supplies as follows (where POP = place both 0 Ω resistors, and NOPOP = neither 0 Ω resistor is placed).															
	<table border="1"> <thead> <tr> <th>Link</th> <th>±12 V</th> <th>±15 V</th> </tr> </thead> <tbody> <tr> <td>LK103</td> <td>POP</td> <td>NOPOP</td> </tr> <tr> <td>LK104</td> <td>NOPOP</td> <td>POP</td> </tr> <tr> <td>LK105</td> <td>NOPOP</td> <td>POP</td> </tr> <tr> <td>LK106</td> <td>POP</td> <td>NOPOP</td> </tr> </tbody> </table>	Link	±12 V	±15 V	LK103	POP	NOPOP	LK104	NOPOP	POP	LK105	NOPOP	POP	LK106	POP	NOPOP
Link	±12 V	±15 V														
LK103	POP	NOPOP														
LK104	NOPOP	POP														
LK105	NOPOP	POP														
LK106	POP	NOPOP														
LK701	AV _{CC} signal source selection. Position A: the AV _{CC} signal is sourced from the on-board supply generation circuitry. Position B: the AV _{CC} signal is sourced from the J703 external socket.															
LK702	DV _{CC} signal source selection. Position A: the DV _{CC} signal is sourced from the on-board supply generation circuitry. Position B: the DV _{CC} signal is sourced from the J701 external socket.															
SL1	REFCAPA/REFCAPB link selection. Inserted: connects REFCAPA to REFCAPB when soldered.															
SL2	REFCAPB/REFCAPC link selection. Inserted: connects REFCAPB to REFCAPC when soldered.															
SL3 to SL14	Not used. Leave unsoldered.															
SL15	V1 buffer selection. Position A: the V1 input signal is buffered through U4. Position B: the V1 input signal is taken directly from J1.															
SL16	V2 buffer selection. Position A: the V2 input signal is buffered through U7. Position B: the V2 input signal is taken directly from J2.															
SL17	V3 buffer selection. Position A: the V3 input signal is buffered through U8. Position B: the V3 input signal is taken directly from J7.															
SL18	V4 buffer selection. Position A: the V4 input signal is buffered through U9. Position B: the V4 input signal is taken directly from J4.															
SL19	V5 buffer selection. Position A: the V5 input signal is buffered through U11. Position B: the V5 input signal is taken directly from J5.															
SL20	V6 buffer selection. Position A: the V6 input signal is buffered through U12. Position B: the V6 input signal is taken directly from J6.															

Table 3. Default Link Positions for Packaged EVAL-AD7656SDZ/EVAL-AD7657SDZ/EVAL-AD7658SDZ

Link No.	Position	Function
LK1	A	Software input is selected.
LK2	A	V_{REF} is not buffered.
LK3	A	The $\overline{WR}/REF_{EN/DIS}$ pin is connected to EVAL-SDP-CB1Z.
LK4	Inserted	The V1 input is grounded.
LK5	Inserted	The V2 input is grounded.
LK6	B	The RANGE pin is connected to GND. The input range is set to $\pm 4 \times V_{REF}$ (can be overridden by control registers in software).
LK7	A	The \overline{STBY} pin is connected to V_{DRIVE} . Normal operation is selected.
LK8	C	The RESET pin is connected to EVAL-SDP-CB1Z.
LK9	B	The \overline{W}/B pin is connected to GND. Word mode is selected.
LK10	A	The BUSY pin is connected to EVAL-SDP-CB1Z.
LK11	B	The CONVST A pin is connected to EVAL-SDP-CB1Z.
LK12	A	The \overline{CS} pin is connected to EVAL-SDP-CB1Z.
LK13	A	The REFIN/REFOUT signal is sourced from AD780.
LK14	Inserted	The V3 input is grounded.
LK15	Inserted	The V4 input is grounded.
LK16	A	The V_{DRIVE} signal is sourced from the on-board 3.3 V supply. (Requires the EVAL-SDP-CB1Z board to be connected.)
LK17	Inserted	The V5 input is grounded.
LK18	Inserted	The V6 input is grounded.
LK19	Removed	An external V_{REF} is disconnected.
LK20	B	The $\overline{SER}/\overline{PAR}$ SEL pin is connected to GND. Parallel mode is selected.
LK21	Removed	The AD780 voltage output is 2.5 V.
LK22	Removed	The CONVST A and CONVST B pins are not linked.
LK23	A	The \overline{RD} pin is connected to EVAL-SDP-CB1Z.
LK24	Removed	An external V_{REF} is disconnected.
LK25	A	The DB10/DOUT C pin is connected to EVAL-SDP-CB1Z.
LK26	A	The DB7/HBEN/DCEN pin is connected to EVAL-SDP-CB1Z.
LK27	A	The DB9/DOUT B pin is connected to EVAL-SDP-CB1Z.
LK28	A	The DB8/DOUT A pin is connected to EVAL-SDP-CB1Z.
LK29	A	The DB14/REFBU \overline{FEN}/DIS pin is connected to EVAL-SDP-CB1Z.
LK30	A	The DB6/SCLK pin is connected to EVAL-SDP-CB1Z.
LK31	A	The DB2/SEL C pin is connected to EVAL-SDP-CB1Z.
LK32	A	The DB1/SEL B pin is connected to EVAL-SDP-CB1Z.
LK33	A	The DB0/SEL A pin is connected to EVAL-SDP-CB1Z.
LK34	B	The CONVST B pin is connected to EVAL-SDP-CB1Z.
LK35	B	The CONVST C pin is connected to EVAL-SDP-CB1Z.
LK36	Removed	The CONVST A and CONVST C pins are not linked.
LK101	A	The on-board op amp power is used.
LK102	A	The on-board op amp power is used.
LK103	NOPOP ¹	The op amp supply rails are set to ± 15 V.
LK104	POP ¹	The op amp supply rails are set to ± 15 V.
LK105	POP ¹	The op amp supply rails are set to ± 15 V.
LK106	NOPOP ¹	The op amp supply rails are set to ± 15 V.
LK701	A	The on-board AV_{CC} is used.
LK702	A	The on-board DV_{CC} is used.
SL1	Removed	The REFCAPA and REFCAPB pins are not linked.
SL2	Removed	The REFCAPB and REFCAPC pins are not linked.
SL3 to SL14	Removed	Not used.
SL15	A	The V1 input is buffered.
SL16	A	The V2 input is buffered.
SL17	A	The V3 input is buffered.
SL18	A	The V4 input is buffered.
SL19	A	The V5 input is buffered.
SL20	A	The V6 input is buffered.

¹ POP = place both 0 Ω resistors; NOPOP = neither 0 Ω resistor is placed.

EVALUATION BOARD CIRCUITRY

ANALOG INPUTS

The V1 to V6 inputs allow a signal to be connected to the board via SMB connectors.

The analog inputs on the [EVAL-AD7656SDZ/EVAL-AD7657SDZ/EVAL-AD7658SDZ](#) are filtered and buffered by the [AD8597](#) ultra-low distortion, ultralow noise (single) op amps. Additional filtering is provided by an R-C filter directly before the [AD7656/AD7657/AD7658](#) inputs. Alternatively, the op amps can be bypassed, and the inputs can be fed directly to the [AD7656/AD7657/AD7658](#) via the R-C filter.

REFERENCE OPTIONS

The following two on-board reference supplies are available:

- [ADR431](#): ultralow noise XFET voltage reference with current sink and source capability
- [AD780](#): 2.5 V/3.0 V ultrahigh precision band gap voltage reference

Alternatively, the [AD7656/AD7657/AD7658](#) can supply an internal reference voltage.

SOCKETS/CONNECTORS

Table 4. Socket/Connector Functions

Socket	Function
V1	Analog Input V1. Buffered to the V1 pin on the AD7656/AD7657/AD7658 .
V2	Analog Input V2. Buffered to the V2 pin on the AD7656/AD7657/AD7658 .
V3	Analog Input V3. Buffered to the V3 pin on the AD7656/AD7657/AD7658 .
V4	Analog Input V4. Buffered to the V4 pin on the AD7656/AD7657/AD7658 .
V5	Analog Input V5. Buffered to the V5 pin on the AD7656/AD7657/AD7658 .
V6	Analog Input V6. Buffered to the V6 pin on the AD7656/AD7657/AD7658 .
J7	Digital inputs/outputs for standalone operation.
J8	Socket for EVAL-SDP-CB1Z evaluation controller board.
J100	Op amp power supply screw terminal connector. Supply rails for op amps.
J701	DV _{CC} screw terminal connector.
J702	The 7 V to 9 V dc transformer power connector.
J703	AV _{CC} screw terminal connector.

MODES OF OPERATION

SDP CONTROLLED MODE

The [AD7656/AD7657/AD7658](#) uses a high speed parallel interface that allows sampling rates of up to 250 kSPS. For more information about the operation of the parallel interface, refer to the [AD7656/AD7657/AD7658](#) data sheet.

The [AD7656/AD7657/AD7658](#) uses the parallel interface to transfer data to the [EVAL-SDP-CB1Z](#).

The [EVAL-AD7656SDZ/EVAL-AD7657SDZ/EVAL-AD7658SDZ](#) communicates with the [EVAL-SDP-CB1Z](#) board using level

shifters. The [EVAL-SDP-CB1Z](#) operates at a 3.3 V logic level, which allows logic voltages that exceed 3.3 V to be used without damaging the SDP interface.

STANDALONE MODE

The [EVAL-AD7656SDZ/EVAL-AD7657SDZ/EVAL-AD7658SDZ](#) can also be used without the [EVAL-SDP-CB1Z](#) controller board. In this case, the [EVAL-AD7656SDZ/EVAL-AD7657SDZ/EVAL-AD7658SDZ](#) is connected to the serial interface using the J7 socket. For more information about the operation of the serial interface, refer to the [AD7656/AD7657/AD7658](#) data sheet.

HOW TO USE THE SOFTWARE FOR EVALUATING THE AD7656/AD7657/AD7658

SETTING UP THE SYSTEM FOR DATA CAPTURE

After completing the steps in the Software Installation Procedures and Evaluation Board Setup Procedures sections, set up the system for data capture as follows:

1. Allow the **Found New Hardware Wizard** to run after the **EVAL-SDP-CB1Z** board is plugged into your PC. (If you are using Windows XP, you may need to search for the **EVAL-SDP-CB1Z** drivers. Choose to automatically search for the drivers for the **EVAL-SDP-CB1Z** board if prompted by the operating system.)
2. Check that the board is connected to the PC correctly using the **Device Manager** of the PC.
 - a. Access the **Device Manager** as follows:
 - i. Right-click **My Computer** and then click **Manage**.
 - ii. A dialog box appears asking for permission to allow the program to make changes to your computer. Click **Yes**.
 - iii. The **Computer Management** box appears. From the list of **System Tools**, click **Device Manager** (see Figure 13).
 - b. Under **ADI Development Tools**, **Analog Devices System Development Platform (32MB)** should appear, indicating that the **EVAL-SDP-CB1Z** driver software is installed and that the board is connected to the PC correctly.

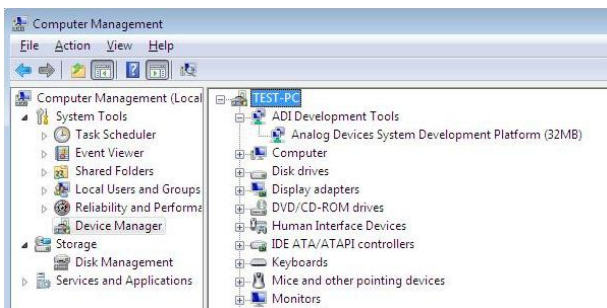

Figure 13. Device Manager:
Checking that the Board Is Connected to the PC Correctly

11338-013

Launching the Software

After completing the steps in the Setting Up the System for Data Capture section, launch the **AD7656/AD7657/AD7658** software as follows:

1. From the **Start** menu, select **Programs > Analog Devices > AD7656_57_58**. The main window of the software then displays.
2. If the **EVAL-AD7656SDZ/EVAL-AD7657SDZ/EVAL-AD7658SDZ** evaluation system is not connected to the USB port via the **EVAL-SDP-CB1Z** when the software is launched, a connectivity error displays (see Figure 14). Connect the evaluation system to the USB port of the PC, wait a few seconds, click **Rescan**, and follow the on-screen instructions.

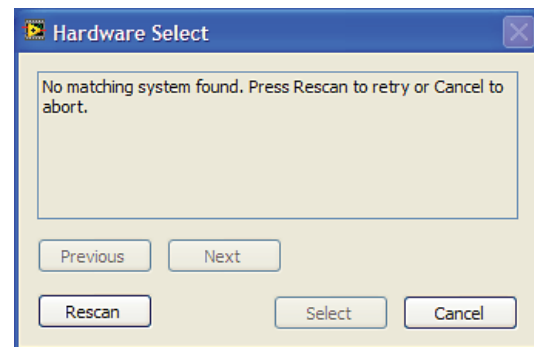
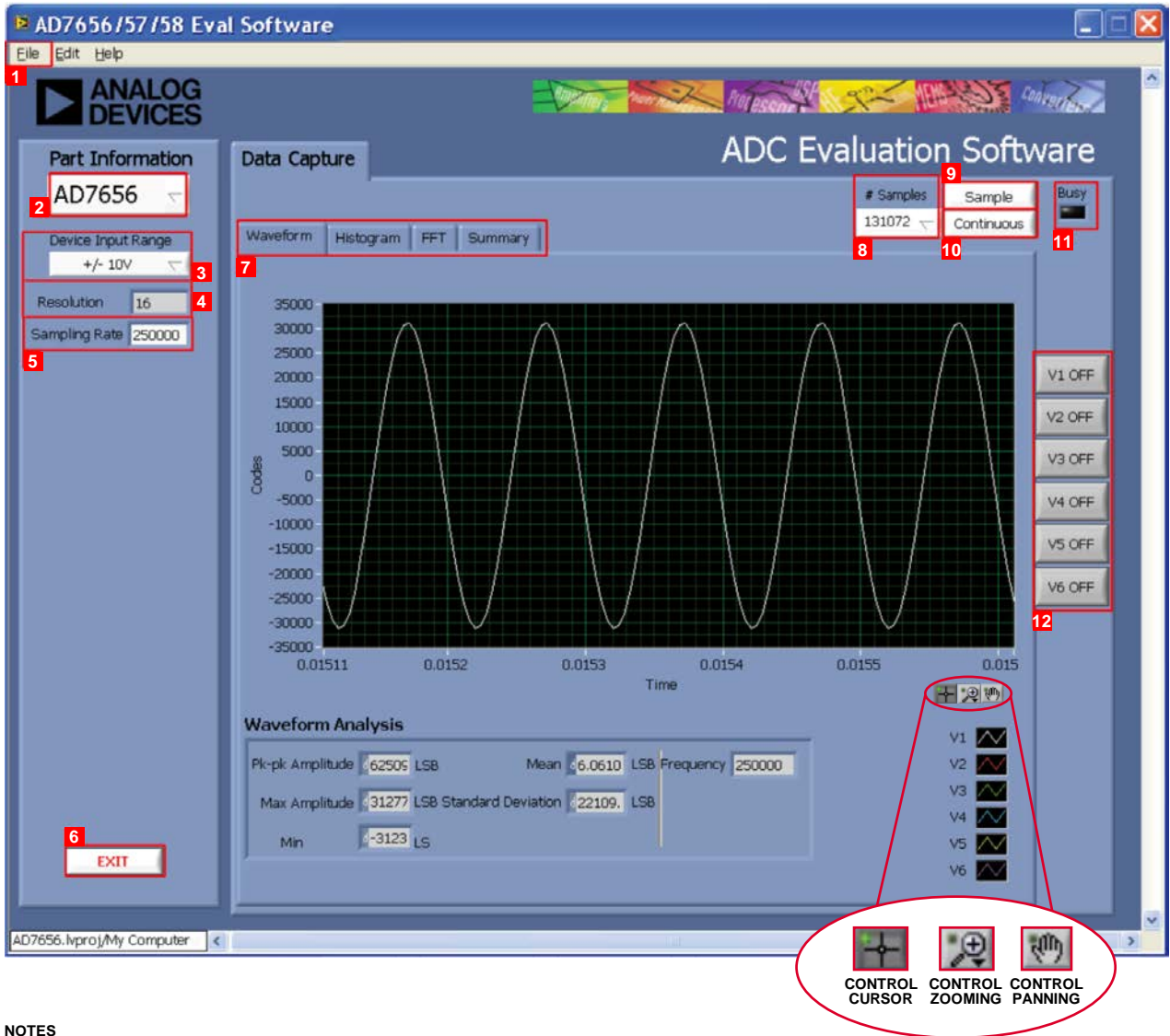

Figure 14. Connectivity Error Alert

11338-014

When the software starts running, it searches for hardware connected to the PC. A dialog box indicates when the evaluation board attached to the PC is detected, and then the main window appears (see Figure 15).



NOTES

1. FOR DETAILS ABOUT THE AREAS HIGHLIGHTED IN RED, SEE THE OVERVIEW OF THE MAIN WINDOW SECTION.

Figure 15. Evaluation Software Main Window

11338-015

OVERVIEW OF THE MAIN WINDOW

The main window of the software is shown in Figure 15 and has the features described in this section.

File Menu (Section 1)

The **File** menu (labeled 1 in Figure 15) offers the choice to

- **Load data:** load previously captured data or example files in .tsv (tab separated values) format for analysis (see Figure 16). (The default location for example files is C:\Program Files\Analog Devices\AD7656_57_58\examples.)
- **Save Data as .tsv:** save captured data in .tsv format for future analysis (see Figure 17).
- **Print Front Panel Picture:** print the main window to the default printer.
- **Save Picture:** save the current screen capture.
- **Exit:** close the application.

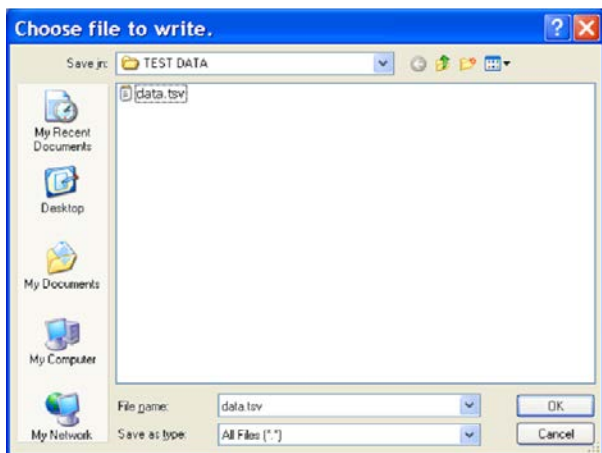

11338-016

Figure 16. Load File Dialog Box:
Loading Previously Captured Data or Example Files in .tsv Format

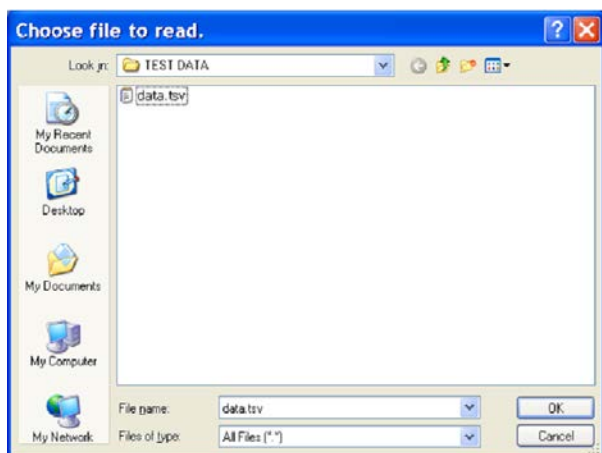

11338-017

Figure 17. Save File Dialog Box:
Saving Data as .tsv

Part Information Box (Section 2)

The **Part Information** box (labeled 2 in Figure 15) allows selecting the generic to be evaluated; choose [AD7656](#), [AD7657](#), or [AD7658](#).

Device Input Range Box (Section 3)

The **Device Input Range** box (labeled 3 in Figure 15), in conjunction with hardware settings, is used to select the voltage range.

Resolution Box (Section 4)

The **Resolution** box (labeled 4 in Figure 15) displays the resolution of the selected part in bits.

Sampling Rate Box (Section 5)

The default sampling frequency in the **Sampling Rate** box (labeled 5 in Figure 15) matches the maximum sample rate of the ADC being evaluated. Although you can adjust the sampling frequency, there are limitations in terms of the sample frequencies that can be entered. If an unusable sample frequency is input, the software automatically adjusts the sample frequency accordingly. Units can be entered as, for example, 10k for 10,000 Hz. The software automatically adjusts the sample frequency according to the ability of the ADC being evaluated. For example, if you enter a value that is beyond the ability of the device, the software indicates this and reverts to the maximum sample frequency.

Exit Button (Section 6)

Clicking **Exit** (labeled 6 in Figure 15) closes the software. Alternatively, you can select **Exit** from the **File** menu.

Tabs Area (Section 7)

There are four tabs available in the tabs area (labeled 7 in Figure 15) of the main window: **Waveform**, **Histogram**, **FFT**, and **Summary**. These tabs display the data in different formats. Navigation tools are provided within each tab to allow you to control the cursor, zooming, and panning (see Figure 15) within the graphs displayed.

Each tab is described in more detail in the Generating a Waveform Analysis Report; Generating a Histogram of the ADC Code Distribution; Generating a Fast Fourier Transform of AC Characteristics; and Generating a Summary of the Waveform, Histogram, and Fast Fourier Transform sections.

Samples Box (Section 8)

The **# Samples** box (labeled 8 in Figure 15) allows you to select the number of samples to analyze. When **Sample** or **Continuous** is clicked, the software requests this number of samples to be taken. This is the total number of samples taken on all channels.

Sample Button (Section 9)

Clicking **Sample** (labeled 9 in Figure 15) performs a single capture, acquiring a set number of samples at the selected sampling rate.

Continuous Button (Section 10)

Clicking **Continuous** (labeled 10 in Figure 15) performs a continuous capture from the ADC. Clicking **Continuous** a second time stops sampling.

Busy LED (Section 11)

The **Busy** LED (labeled 11 in Figure 15) indicates when a read from the [EVAL-SDP-CBIZ](#) board is in progress.

Channel Display Buttons (Section 12)

Clicking the buttons in this area (labeled 12 in Figure 15) allows you to display multiple channel reads. (Note that for FFT analysis, you can select only one channel to be displayed.)

GENERATING A WAVEFORM ANALYSIS REPORT

Figure 18 illustrates the waveform capture tab for a 10 kHz sine wave input signal.

The **Waveform Analysis** area (labeled 1 in Figure 18) reports the amplitudes recorded from the captured signal and the frequency of the signal tone.



Figure 18. Waveform Tab

11938-018

GENERATING A HISTOGRAM OF THE ADC CODE DISTRIBUTION

The **Histogram** tab can be used to perform ac testing or, more commonly, dc testing. This tab shows the ADC code distribution of the input and computes the mean and standard deviation, which are displayed as **Mean** and **Transition Noise**, respectively, in the **Histogram Analysis** area (labeled 1 in Figure 19).

Figure 19 shows the histogram with ac input for a 10 kHz sine wave applied to the ADC input and the resulting calculations.

AC Input

To perform a histogram test of ac input,

1. Apply a signal source to the selected analog input on the board.
2. Click the **Histogram** tab from the main window.
3. Click **Sample**.

Raw data is then captured and passed to the PC for statistical computations, and various measured values are displayed in the **Histogram Analysis** area.

DC Input

A histogram test of dc input can be performed with or without an external source because the evaluation board has a buffered $V_{REF}/2$ source at the ADC input.

To perform a histogram test of dc input,

1. If an external source is being used, apply a signal source to the selected analog input. It may be required to filter the signal to ensure that the dc source is noise-compatible with the ADC.
2. Click the **Histogram** tab from the main window.
3. Click **Sample**.

Raw data is then captured and passed to the PC for statistical computations, and various measured values are displayed in the **Histogram Analysis** area.

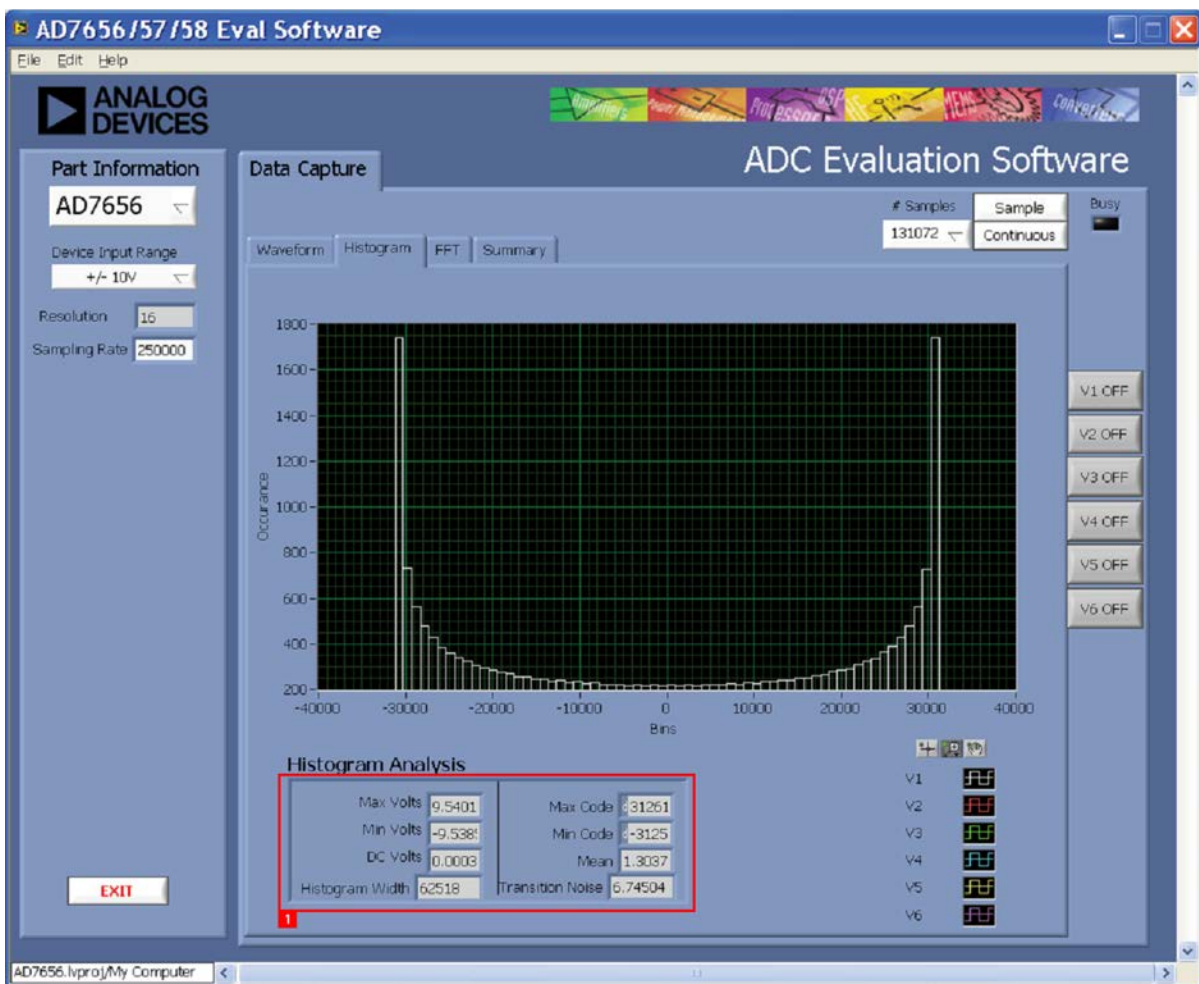

Figure 19. Histogram Tab

GENERATING A FAST FOURIER TRANSFORM OF AC CHARACTERISTICS

Figure 20 shows the FFT tab. This feature tests the traditional ac characteristics of the converter and displays a fast Fourier transform (FFT) of the results.

To perform an ac FFT test,

1. Apply a sinusoidal signal with low distortion (better than 115 dB) to the evaluation board at the selected analog input. To attain the requisite low distortion, which is necessary to allow true evaluation of the part, one option is to
 - a. Filter the input signal from the ac source. Choose an appropriate band-pass filter based on the sinusoidal signal applied.
 - b. If a low frequency band-pass filter is used when the full-scale input range is more than a few volts peak-to-peak, use the on-board amplifiers to amplify the signal, thus preventing the filter from distorting the input signal.

2. Click the **FFT** tab from the main window.
3. Click **Sample**.

As in the histogram test, raw data is then captured and passed to the PC, which performs the FFT and displays the resulting SNR, THD, and SINAD.

The **Spectrum Analysis** box displays the results of the captured data.

- The area labeled 1 in Figure 20 shows the input signal information.
- The area labeled 2 in Figure 20 displays the fundamental frequency and amplitude in addition to the second to fifth harmonics.
- The area labeled 3 in Figure 20 displays the performance data, including the SNR, THD, and SINAD.

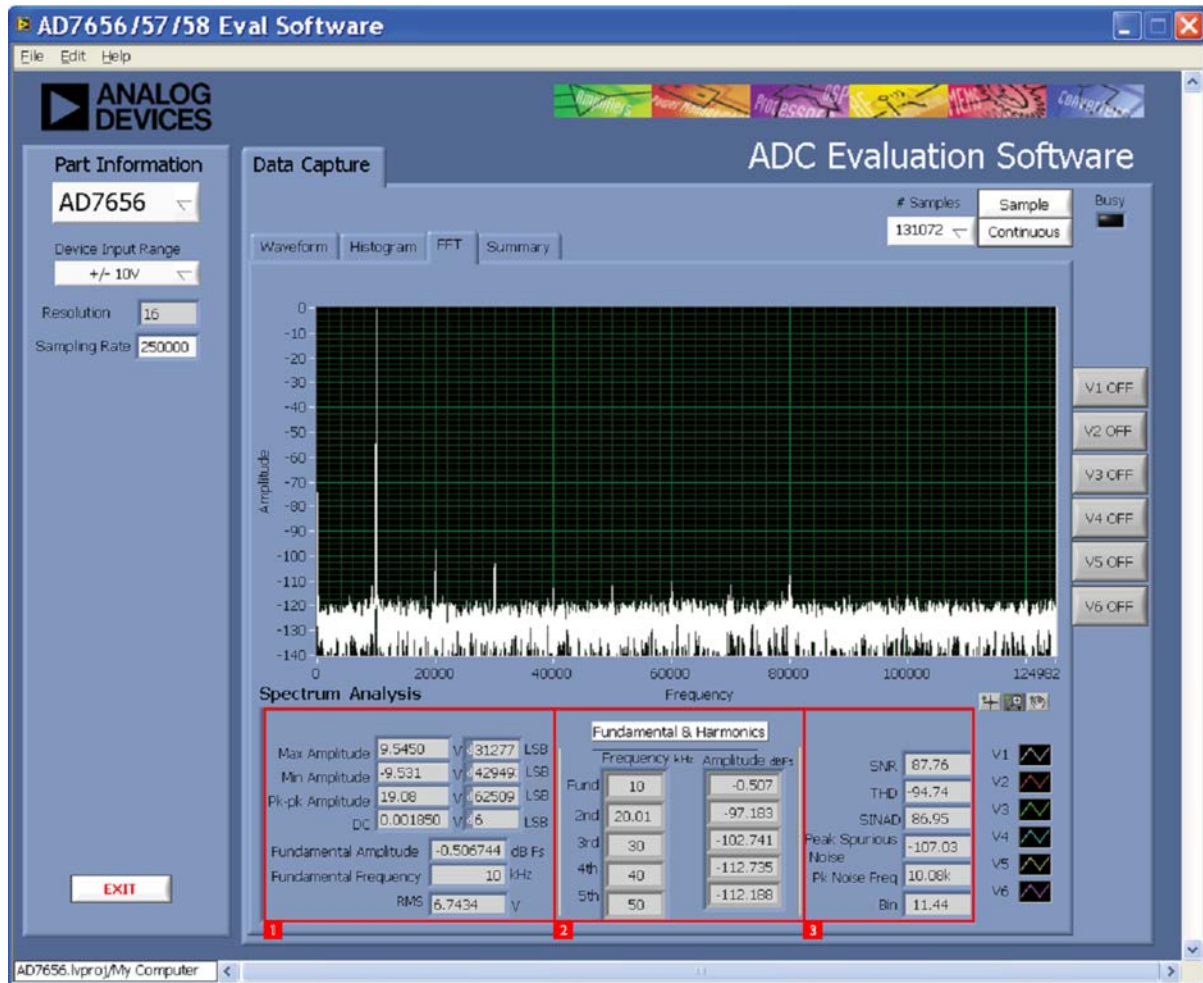

Figure 20. FFT Tab

11338-020

GENERATING A SUMMARY OF THE WAVEFORM, HISTOGRAM, AND FAST FOURIER TRANSFORM

Figure 21 shows the **Summary** tab. The **Summary** tab captures all the display information and provides it in one panel with a synopsis of the information, including key performance parameters such as SNR and THD.

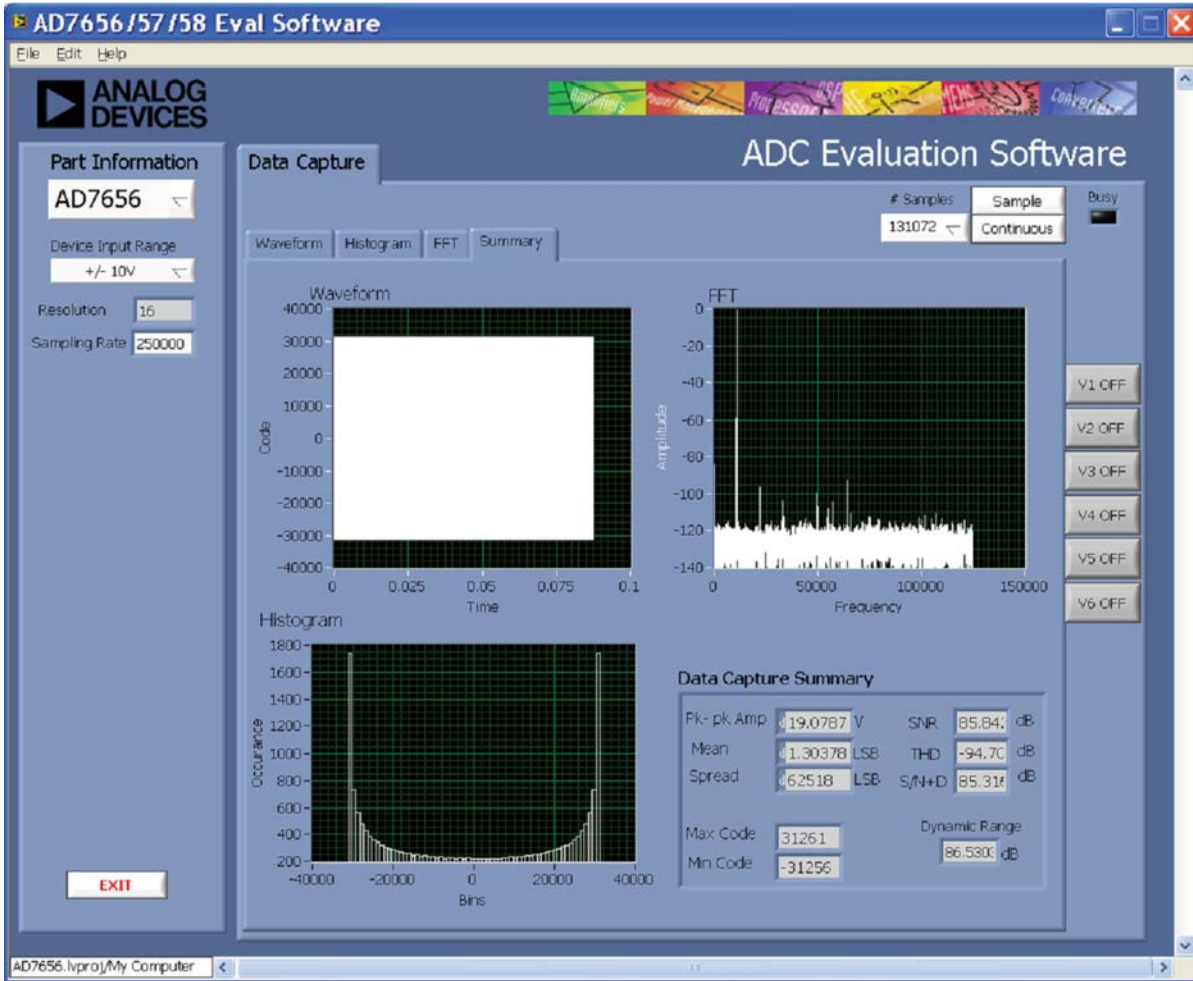

Figure 21. Summary Tab

RELATED LINKS

Resource	Description
AD7656	Product Page: 250 kSPS, 6-Channel, Simultaneous Sampling, Bipolar 16-Bit ADC
AD7657	Product Page: 250 kSPS, 6-Channel, Simultaneous Sampling, Bipolar 14-Bit ADC
AD7658	Product Page: 250 kSPS, 6-Channel, Simultaneous Sampling, Bipolar 12-Bit ADC
AD8597	Product Page: Ultralow Distortion, Ultralow Noise Op Amp (Single)
AD8031	Product Page: 2.7 V, 800 μ A, 80 MHz Rail-to-Rail I/O Single Amplifier
ADP1613	Product Page: 650 kHz/1.3 MHz Step-Up PWM DC-to-DC Switching Converter with 2.0 A Current Limit
ADP3303-5	Product Page: High Accuracy anyCAP 200 mA Low Dropout Linear Regulator
ADP2301	Product Page: 1.2 A, 20 V, 1.4 MHz Nonsynchronous Step-Down Switching Regulator
ADM1185	Product Page: Quad Voltage Monitor and Sequencer
ADP190	Product Page: Logic Controlled, High-Side Power Switch
ADG3308	Product Page: Low Voltage, 1.15 V to 5.5 V, 8-Channel Bidirectional Logic Level Translator
ADR431	Product Page: Ultralow Noise XFET 2.5 V Voltage Reference with Current Sink and Source Capability
AD780	Product Page: 2.5V/3.0V Ultrahigh Precision Band Gap Voltage Reference
EngineerZone	Online Community: Analog Devices Online Technical Support Community
Circuits from the Lab	Reference Circuits: Circuit Designs that Have Been Built and Tested to Ensure Function and Performance and that Address Common Analog, RF/IF, and Mixed-Signal Design Challenges by Applying Analog Devices' Vast Applications Expertise

**ESD Caution**

ESD (electrostatic discharge) sensitive device. Charged devices and circuit boards can discharge without detection. Although this product features patented or proprietary protection circuitry, damage may occur on devices subjected to high energy ESD. Therefore, proper ESD precautions should be taken to avoid performance degradation or loss of functionality.

Legal Terms and Conditions

By using the evaluation board discussed herein (together with any tools, components documentation or support materials, the "Evaluation Board"), you are agreeing to be bound by the terms and conditions set forth below ("Agreement") unless you have purchased the Evaluation Board, in which case the Analog Devices Standard Terms and Conditions of Sale shall govern. Do not use the Evaluation Board until you have read and agreed to the Agreement. Your use of the Evaluation Board shall signify your acceptance of the Agreement. This Agreement is made by and between you ("Customer") and Analog Devices, Inc. ("ADI"), with its principal place of business at One Technology Way, Norwood, MA 02062, USA. Subject to the terms and conditions of the Agreement, ADI hereby grants to Customer a free, limited, personal, temporary, non-exclusive, non-sublicensable, non-transferable license to use the Evaluation Board FOR EVALUATION PURPOSES ONLY. Customer understands and agrees that the Evaluation Board is provided for the sole and exclusive purpose referenced above, and agrees not to use the Evaluation Board for any other purpose. Furthermore, the license granted is expressly made subject to the following additional limitations: Customer shall not (i) rent, lease, display, sell, transfer, assign, sublicense, or distribute the Evaluation Board; and (ii) permit any Third Party to access the Evaluation Board. As used herein, the term "Third Party" includes any entity other than ADI, Customer, their employees, affiliates and in-house consultants. The Evaluation Board is NOT sold to Customer; all rights not expressly granted herein, including ownership of the Evaluation Board, are reserved by ADI. CONFIDENTIALITY. This Agreement and the Evaluation Board shall all be considered the confidential and proprietary information of ADI. Customer may not disclose or transfer any portion of the Evaluation Board to any other party for any reason. Upon discontinuation of use of the Evaluation Board or termination of this Agreement, Customer agrees to promptly return the Evaluation Board to ADI. ADDITIONAL RESTRICTIONS. Customer may not disassemble, decompile or reverse engineer chips on the Evaluation Board. Customer shall inform ADI of any occurred damages or any modifications or alterations it makes to the Evaluation Board, including but not limited to soldering or any other activity that affects the material content of the Evaluation Board. Modifications to the Evaluation Board must comply with applicable law, including but not limited to the RoHS Directive. TERMINATION. ADI may terminate this Agreement at any time upon giving written notice to Customer. Customer agrees to return to ADI the Evaluation Board at that time. LIMITATION OF LIABILITY. THE EVALUATION BOARD PROVIDED HEREUNDER IS PROVIDED "AS IS" AND ADI MAKES NO WARRANTIES OR REPRESENTATIONS OF ANY KIND WITH RESPECT TO IT. ADI SPECIFICALLY DISCLAIMS ANY REPRESENTATIONS, ENDORSEMENTS, GUARANTEES, OR WARRANTIES, EXPRESS OR IMPLIED, RELATED TO THE EVALUATION BOARD INCLUDING, BUT NOT LIMITED TO, THE IMPLIED WARRANTY OF MERCHANTABILITY, TITLE, FITNESS FOR A PARTICULAR PURPOSE OR NON-INFRINGEMENT OF INTELLECTUAL PROPERTY RIGHTS. IN NO EVENT WILL ADI AND ITS LICENSORS BE LIABLE FOR ANY INCIDENTAL, SPECIAL, INDIRECT, OR CONSEQUENTIAL DAMAGES RESULTING FROM CUSTOMER'S POSSESSION OR USE OF THE EVALUATION BOARD, INCLUDING BUT NOT LIMITED TO LOST PROFITS, DELAY COSTS, LABOR COSTS OR LOSS OF GOODWILL. ADI'S TOTAL LIABILITY FROM ANY AND ALL CAUSES SHALL BE LIMITED TO THE AMOUNT OF ONE HUNDRED US DOLLARS (\$100.00). EXPORT. Customer agrees that it will not directly or indirectly export the Evaluation Board to another country, and that it will comply with all applicable United States federal laws and regulations relating to exports. GOVERNING LAW. This Agreement shall be governed by and construed in accordance with the substantive laws of the Commonwealth of Massachusetts (excluding conflict of law rules). Any legal action regarding this Agreement will be heard in the state or federal courts having jurisdiction in Suffolk County, Massachusetts, and Customer hereby submits to the personal jurisdiction and venue of such courts. The United Nations Convention on Contracts for the International Sale of Goods shall not apply to this Agreement and is expressly disclaimed.