



# STPS10H100CT/CG/CR/CFP

## HIGH VOLTAGE POWER SCHOTTKY RECTIFIER

### MAIN PRODUCT CHARACTERISTICS

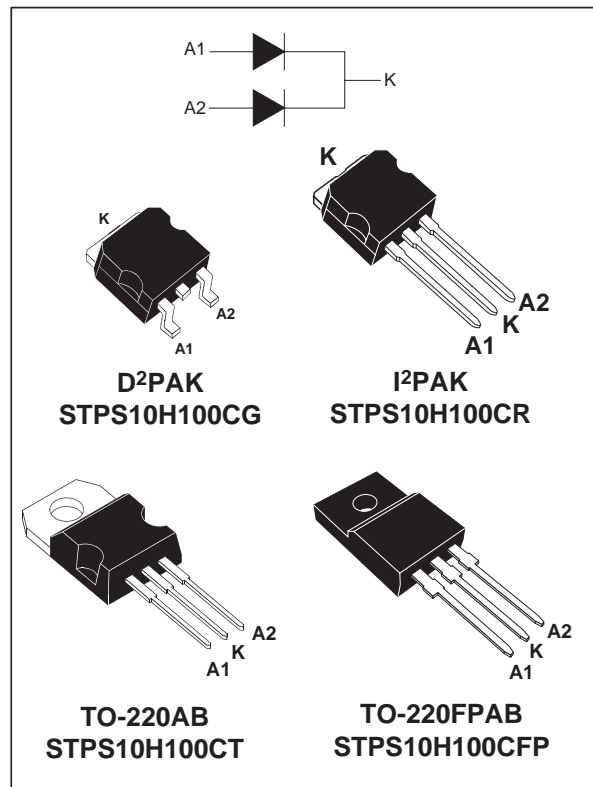
$I_{F(AV)}$	2 x 5 A
$V_{RRM}$	100 V
$T_j$	175°C
$V_F(max)$	0.61 V

### FEATURES AND BENEFITS

- HIGH JUNCTION TEMPERATURE CAPABILITY FOR CONVERTERS LOCATED IN CONFINED ENVIRONMENT
- LOW LEAKAGE CURRENT AT HIGH TEMPERATURE
- LOW STATIC AND DYNAMIC LOSSES AS A RESULT OF THE SCHOTTKY BARRIER
- AVALANCHE CAPABILITY SPECIFIED

### DESCRIPTION

Schottky barrier rectifier designed for high frequency miniature Switched Mode Power Supplies such as adaptators and on board DC/DC converters. Packaged in TO-220AB, TO-220FPAB, D<sup>2</sup>PAK and I<sup>2</sup>PAK.



### ABSOLUTE RATINGS (limiting values, per diode)

Symbol	Parameter			Value	Unit	
$V_{RRM}$	Repetitive peak reverse voltage			100	V	
$I_{F(RMS)}$	RMS forward current			10	A	
$I_{F(AV)}$	Average forward current $\delta = 0.5$	TO-220AB	$T_c = 165^\circ\text{C}$	per diode	5	A
		D <sup>2</sup> PAK / I <sup>2</sup> PAK				
		TO-220FPAB	$T_c = 160^\circ\text{C}$	10		
$I_{FSM}$	Surge non repetitive forward current		$t_p = 10\text{ ms}$ sinusoidal	180	A	
$I_{RRM}$	Repetitive peak reverse current		$t_p = 2\ \mu\text{s}$ square F = 1kHz	1	A	
$P_{ARM}$	Repetitive peak avalanche power		$t_p = 1\ \mu\text{s}$ $T_j = 25^\circ\text{C}$	7200	W	
$T_{stg}$	Storage temperature range			- 65 to + 175	°C	
$T_j$	Maximum operating junction temperature *			175	°C	
dV/dt	Critical rate of rise of reverse voltage			10000	V/ $\mu\text{s}$	

\* :  $\frac{dP_{tot}}{dT_j} < \frac{1}{R_{th(j-a)}}$  thermal runaway condition for a diode on its own heatsink

# STPS10H100CT/CG/CR/CFP

## THERMAL RESISTANCES

Symbol	Parameter		Value	Unit	
$R_{th(j-c)}$	Junction to case	D2PAK / I2PAK TO-220AB	Per diode	2.2	$^{\circ}\text{C}/\text{W}$
			Total	1.3	
$R_{th(c)}$			Coupling	0.3	
$R_{th(j-c)}$	Junction to case	TO-220FPAB	Per diode	4.5	$^{\circ}\text{C}/\text{W}$
			Total	3.5	
$R_{th(c)}$			Coupling	2.5	

When the diodes 1 and 2 are used simultaneously :

$$\Delta T_j(\text{diode 1}) = P(\text{diode 1}) \times R_{th(j-c)}(\text{Per diode}) + P(\text{diode 2}) \times R_{th(c)}$$

## STATIC ELECTRICAL CHARACTERISTICS (per diode)

Symbol	Parameter	Tests conditions		Min.	Typ.	Max.	Unit
$I_R^*$	Reverse leakage current	$T_j = 25^{\circ}\text{C}$	$V_R = V_{RRM}$			3.5	$\mu\text{A}$
		$T_j = 125^{\circ}\text{C}$			1.3	4.5	$\text{mA}$
$V_F^{**}$	Forward voltage drop	$T_j = 25^{\circ}\text{C}$	$I_F = 5 \text{ A}$			0.73	V
		$T_j = 125^{\circ}\text{C}$			0.57	0.61	
		$T_j = 25^{\circ}\text{C}$	$I_F = 10 \text{ A}$			0.85	
		$T_j = 125^{\circ}\text{C}$			0.66	0.71	

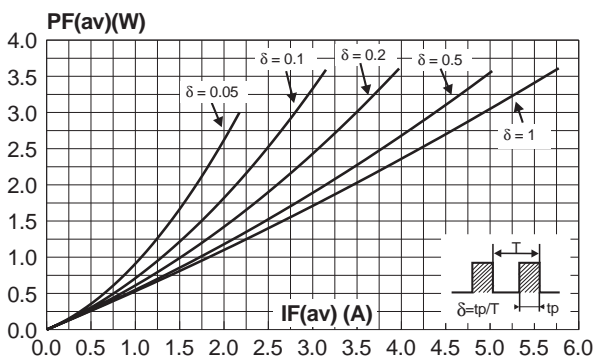
Pulse test : \*  $t_p = 5 \text{ ms}$ ,  $\delta < 2\%$

\*\*  $t_p = 380 \mu\text{s}$ ,  $\delta < 2\%$

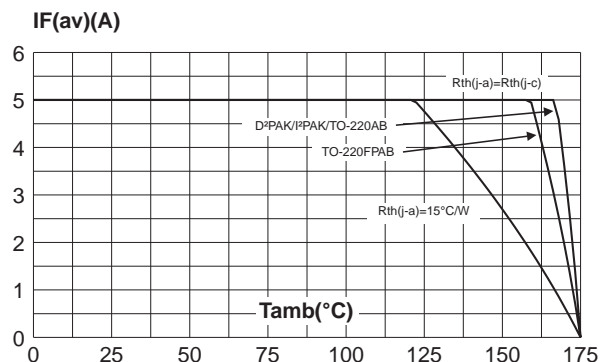
To evaluate the maximum conduction losses use the following equation :

$$P = 0.51 \times I_{F(AV)} + 0.02 \times I_{F(RMS)}^2$$

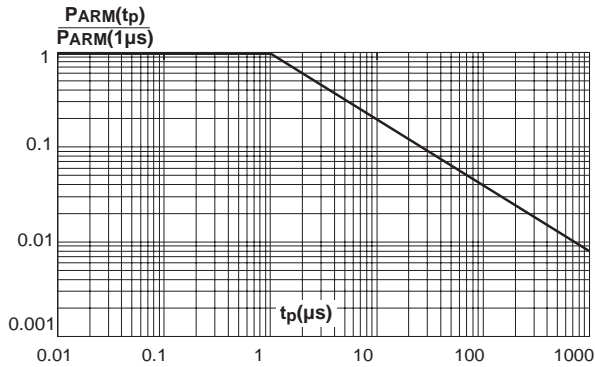
**Fig. 1:** Average forward power dissipation versus average forward current (per diode).



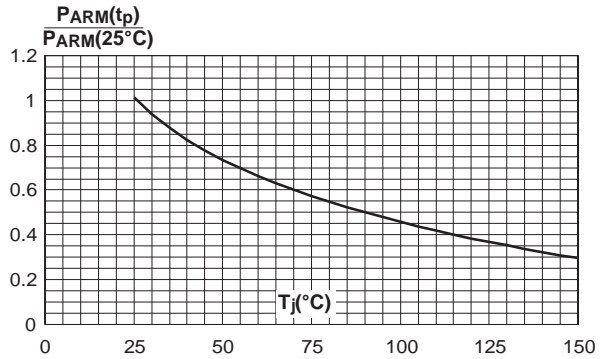
**Fig. 2:** Average forward current versus ambient temperature ( $\delta=0.5$ , per diode).



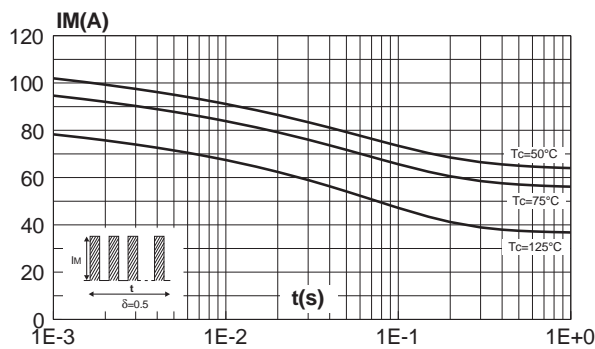
**Fig. 3:** Normalized avalanche power derating versus pulse duration.



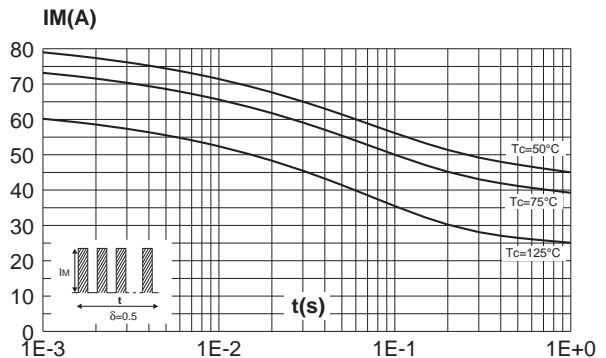
**Fig. 4:** Normalized avalanche power derating versus junction temperature.



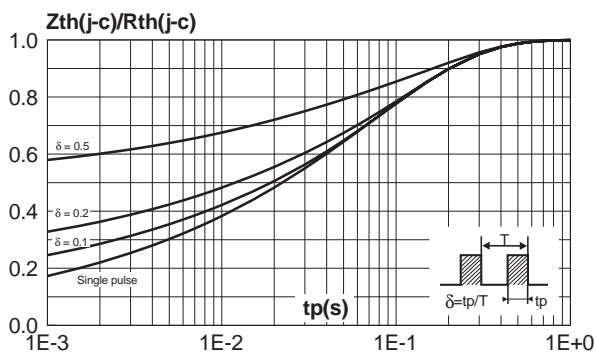
**Fig. 5-1:** Non repetitive surge peak forward current versus overload duration (maximum values, per diode)



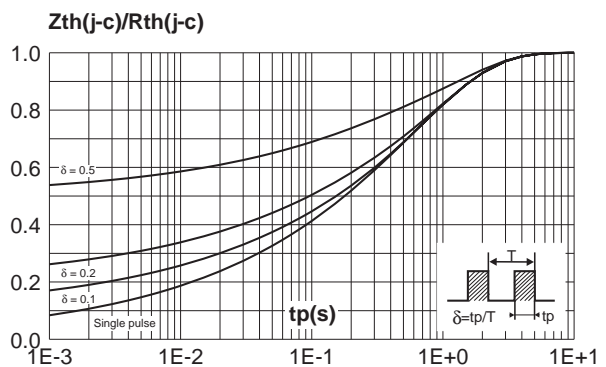
**Fig. 5-2:** Non repetitive surge peak forward current versus overload duration (maximum values, per diode)(TO-220FPAB)



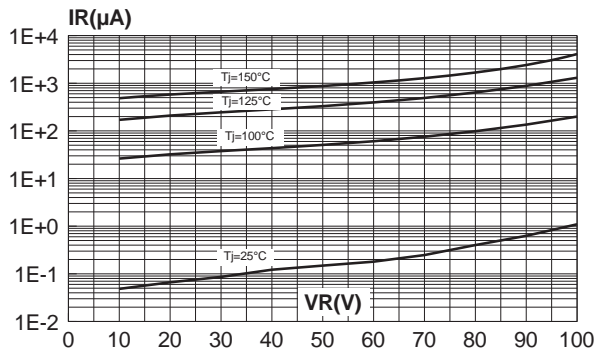
**Fig. 6-1:** Relative variation of thermal impedance junction to case versus pulse duration (per diode).



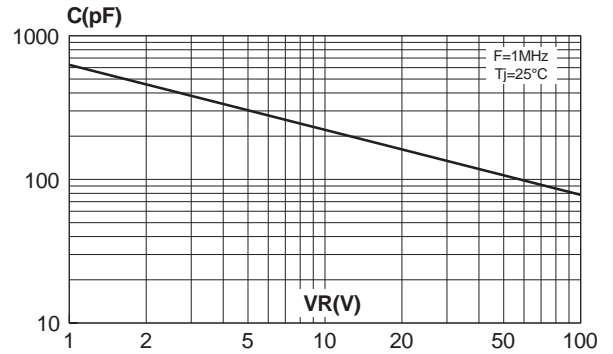
**Fig. 6-2:** Relative variation of thermal impedance junction to case versus pulse duration (per diode).(TO-220FPAB)



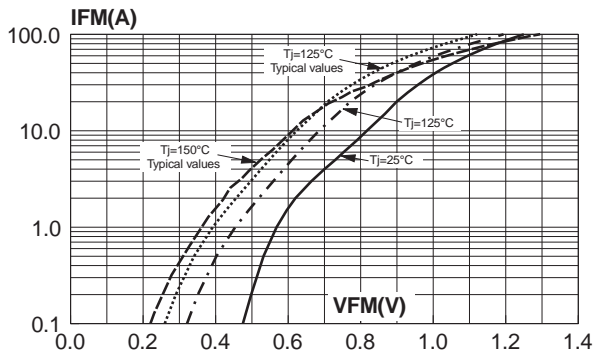
**Fig. 7:** Reverse leakage current versus reverse voltage applied (typical values, per diode).



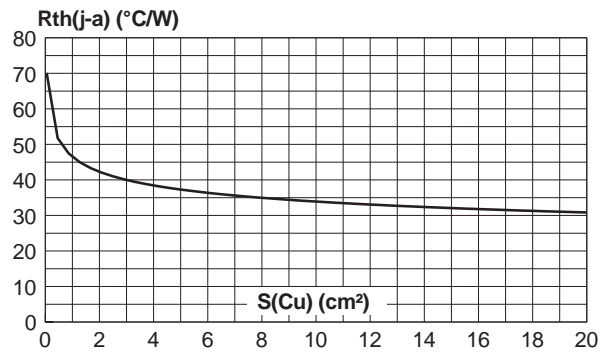
**Fig. 8:** Junction capacitance versus reverse voltage applied (typical values, per diode).



**Fig. 9:** Forward voltage drop versus forward current (maximum values, per diode).

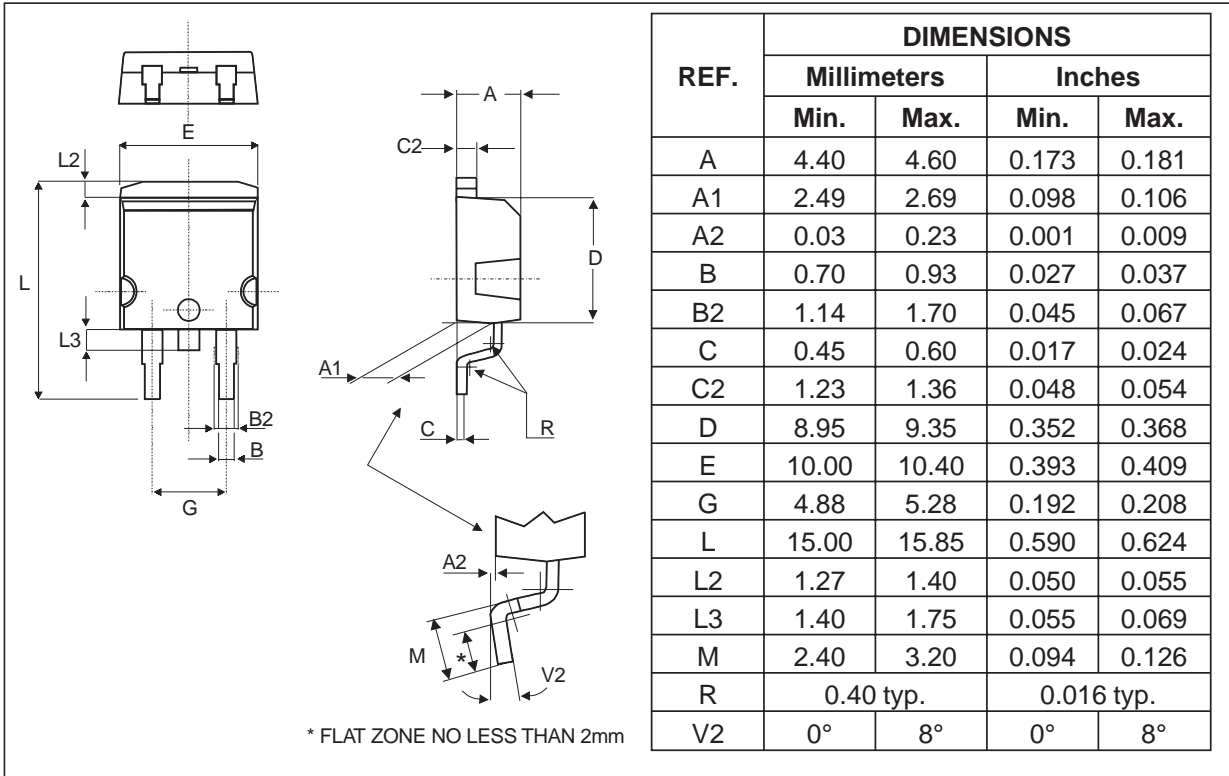


**Fig. 10:** Thermal resistance junction to ambient versus copper surface under tab (Epoxy printed circuit board FR4, copper thickness: 35 $\mu m$ )

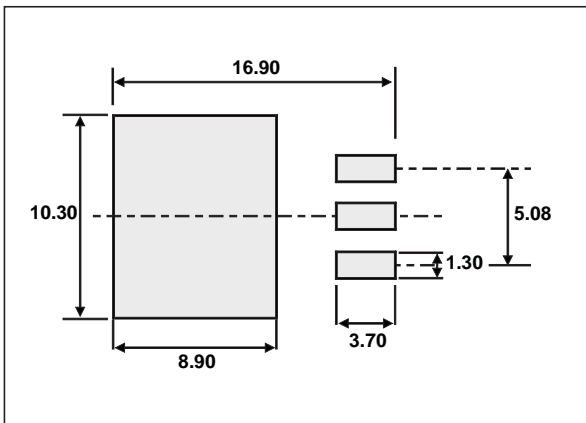


**STPS10H100CT/CG/CR/CFP**

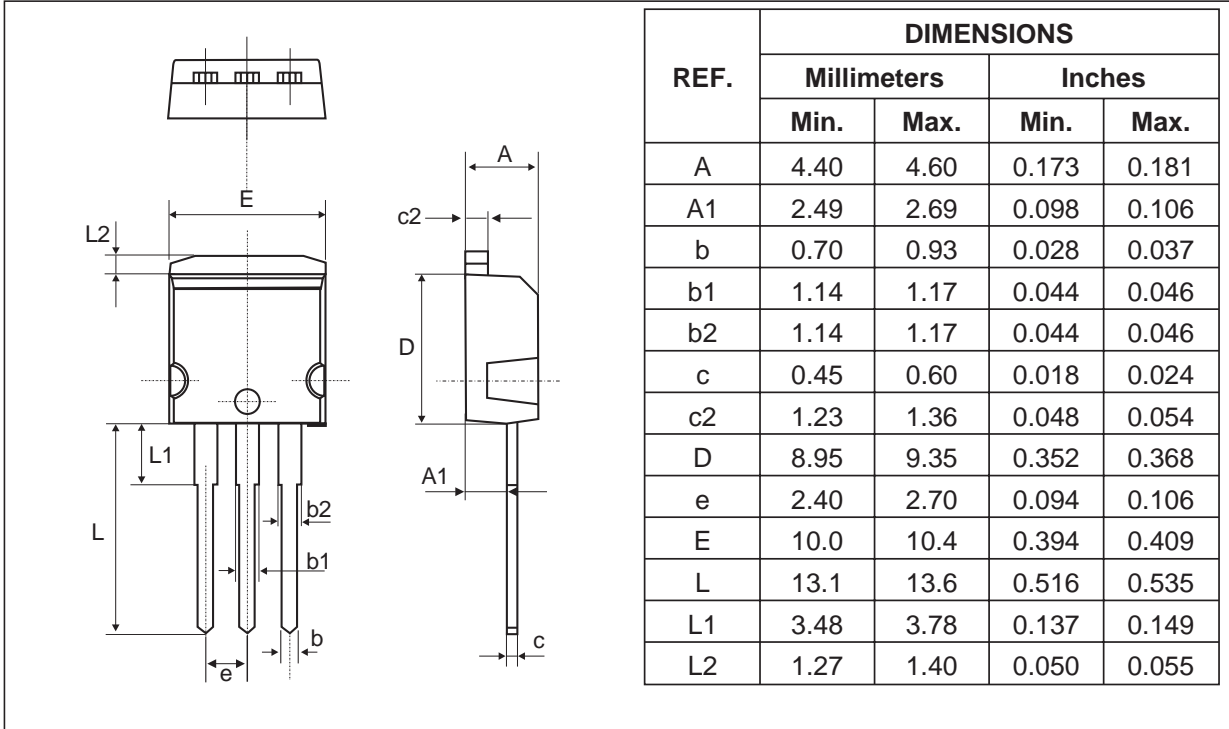
**PACKAGE MECHANICAL DATA**  
D<sup>2</sup>PAK



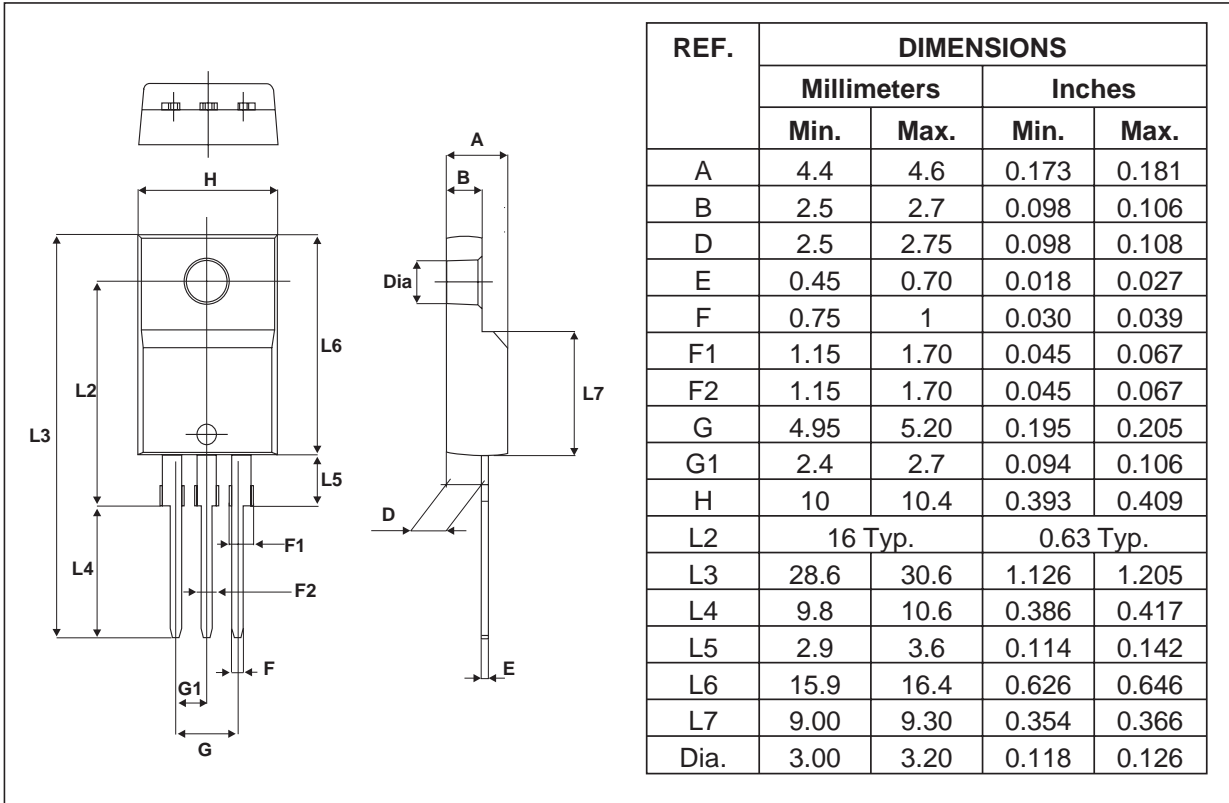
**FOOT PRINT** in millimeters



**PACKAGE MECHANICAL DATA**  
i<sup>2</sup>PAK

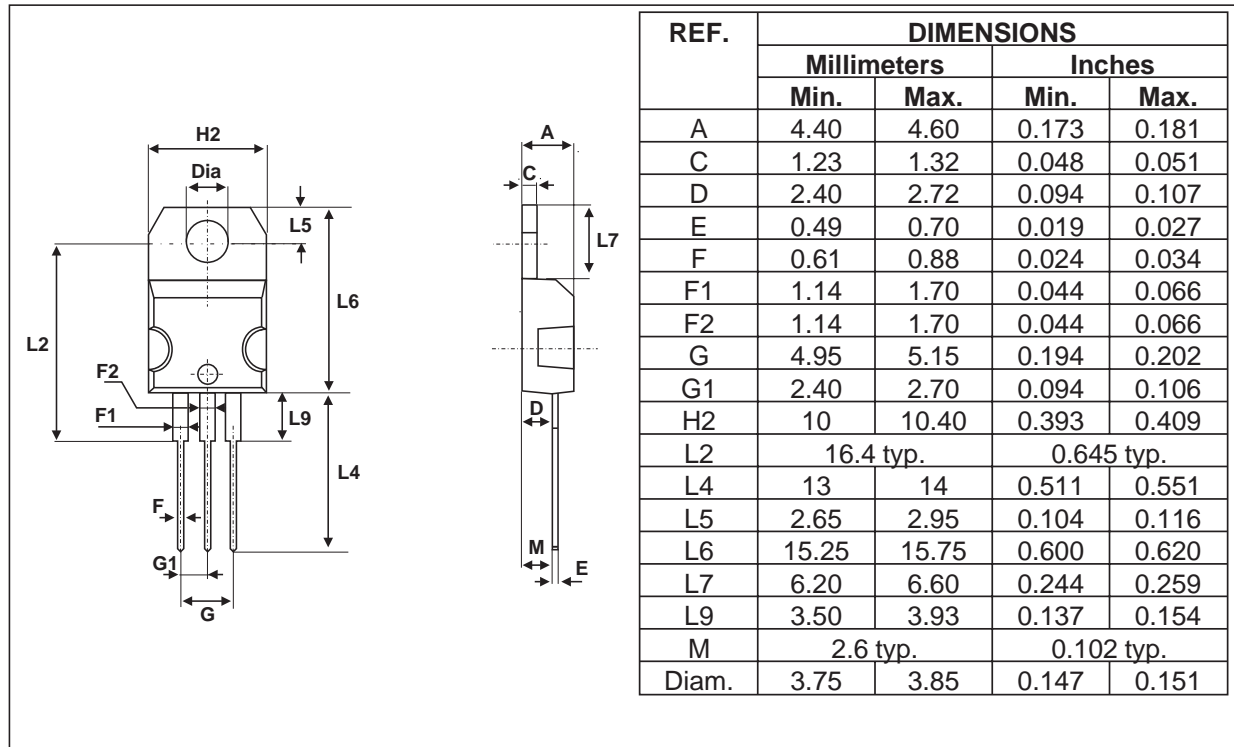


**PACKAGE MECHANICAL DATA**  
TO-220FPAB



# STPS10H100CT/CG/CR/CFP

## PACKAGE MECHANICAL DATA TO-220AB



- Cooling method: C.
- Recommended torque value: 0.55 m.N
- Maximum torque value 0.70 m.N

Ordering type	Marking	Package	Weight	Base qty	Delivery mode
STPS10H100CT	STPS10H100CT	TO-220AB	2.20g	50	Tube
STPS10H100CFP	STPS10H100CFP	TO-220FPAB	2.0 g	50	Tube
STPS10H100CG	STPS10H100CG	D <sup>2</sup> PAK	1.48g	50	Tube
STPS10H100CG-TR	STPS10H100CG	D <sup>2</sup> PAK	1.48g	1000	Tape and reel
STPS10H100CR	STPS10H100CR	I <sup>2</sup> PAK	1.49g	50	Tube

- Epoxy meets UL94,V0

Information furnished is believed to be accurate and reliable. However, STMicroelectronics assumes no responsibility for the consequences of use of such information nor for any infringement of patents or other rights of third parties which may result from its use. No license is granted by implication or otherwise under any patent or patent rights of STMicroelectronics. Specifications mentioned in this publication are subject to change without notice. This publication supersedes and replaces all information previously supplied. STMicroelectronics products are not authorized for use as critical components in life support devices or systems without express written approval of STMicroelectronics.

The ST logo is a registered trademark of STMicroelectronics  
 © 2003 STMicroelectronics - Printed in Italy - All rights reserved.  
 STMicroelectronics GROUP OF COMPANIES  
 Australia - Brazil - Canada - China - Finland - France - Germany  
 Hong Kong - India - Israel - Italy - Japan - Malaysia - Malta - Morocco - Singapore  
 Spain - Sweden - Switzerland - United Kingdom - United States.

<http://www.st.com>

