

FOD816 Series 4-Pin Phototransistor Optocouplers

Features

- AC input response
- Applicable to Pb-free IR reflow soldering
- Compact 4-pin package
- High current transfer ratio: 600% minimum
- Safety agency approvals pending
- High input-output isolation voltage of 5000Vrms

Applications

- Power supply regulators
- Digital logic inputs
- Microprocessor inputs

Description

The FOD816 consists of two gallium arsenide infrared emitting diodes, connected in inverse parallel, driving a silicon photodarlington output in a 4-pin dual in-line package.

Functional Block Diagram

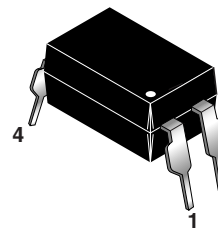
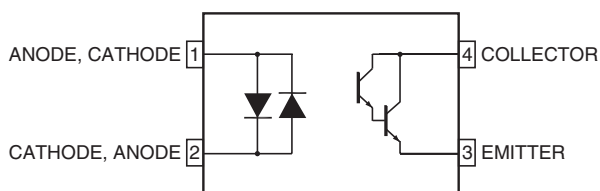

Absolute Maximum Ratings (T_A = 25°C Unless otherwise specified.)

Parameter	Symbol	Value	Units
TOTAL DEVICE			
Storage Temperature	T _{STG}	-55 to +125	°C
Operating Temperature	T _{OPR}	-30 to +100	°C
Lead Solder Temperature	T _{SOL}	260 for 10 sec	°C
Total Power Dissipation	P _{TOT}	200	mW
INPUT			
Forward Current	I _F	±50	mA
Power Dissipation	P	70	mW
OUTPUT			
Collector-Emitter Voltage	V _{CEO}	35	V
Emitter-Collector Voltage	V _{ECO}	6	V
Collector Current	I _C	80	mA
Collector Power Dissipation	P _C	150	mW

Electrical/Characteristics ($T_A = 25^\circ\text{C}$ Unless otherwise specified.)

Individual Component Characteristics

Parameter	Test Conditions	Symbol	Min	Typ	Max	Unit
INPUT						
Forward Voltage	($I_F = \pm 20 \text{ mA}$)	V_F	—	1.2	1.4	V
Terminal Capacitance	($V = 0, f = 1 \text{ kHz}$)	C_t	—	50	250	pF
OUTPUT						
Collector Dark Current	($V_{CE} = 10 \text{ V}, I_F = 0$)	I_{CEO}	—	—	1	μA
Collector-Emitter Breakdown Voltage	($I_C = 0.1 \text{ mA}, I_F = 0$)	BV_{CEO}	35	—	—	V
Emitter-Collector Breakdown Voltage	($I_E = 10 \mu\text{A}, I_F = 0$)	BV_{ECO}	6	—	—	V

Transfer Characteristics ($T_A = 25^\circ\text{C}$ Unless otherwise specified.)

DC Characteristic	Test Conditions	Symbol	Min	Typ	Max	Unit
Collector Current	($I_F = \pm 1 \text{ mA}, V_{CE} = 2 \text{ V}$)	I_C	6	—	75	mA
Current Transfer Ratio ¹		CTR	600	—	7,500	%
Collector-Emitter Saturation Voltage	($I_F = \pm 20 \text{ mA}, I_C = 5 \text{ mA}$)	$V_{CE(sat)}$	—	0.8	1	V
Isolation Resistance	(DC500V 40~60% R.H.)	R_{iso}	5×10^{10}	1×10^{11}	—	Ω
Floating Capacitance	($V = 0, f = 1 \text{ MHz}$)	C_f	—	0.6	1	pF
Cut-Off Frequency	($V_{CE} = 5 \text{ V}, I_C = 2 \text{ mA}, R_L = 100 \Omega, -3\text{dB}$)	f_C	1	6	—	KHz
Response Time (Rise)	($V_{CE} = 2 \text{ V}, I_C = 10 \text{ mA}, R_L = 100 \Omega$)	t_r	—	60	300	μs
Response Time (Fall)		t_f	—	53	250	μs

Isolation Characteristics

Characteristic	Test Conditions	Symbol	Min	Typ	Max	Units
Input-Output Isolation Voltage (note 3)	$f = 60\text{Hz}, t = 1 \text{ min}$	V_{ISO}	5000			Vac(rms)
Isolation Resistance	($V_{I-O} = 500 \text{ VDC}$)	R_{ISO}	5×10^{10}	10^{11}		Ω
Isolation Capacitance	($V_{I-O} = 0, f = 1 \text{ MHz}$)	C_{ISO}		0.6	1.0	pf

NOTES

1. Current Transfer Ratio (CTR) = $I_C/I_F \times 100\%$.

Typical Electrical/Optical Characteristic Curves ($T_A = 25^\circ\text{C}$ Unless otherwise specified.)

Fig. 1 Forward Current vs. Ambient Temperature

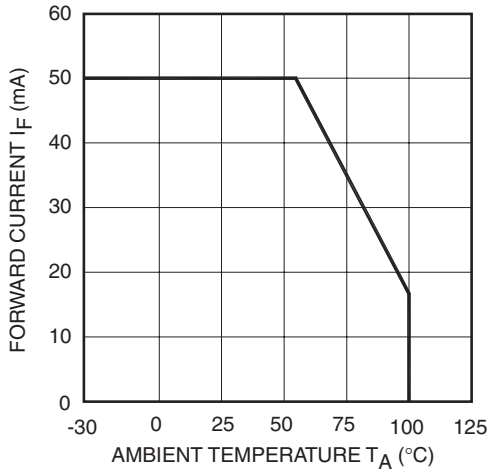

Fig. 2 Collector Power Dissipation vs. Ambient Temperature

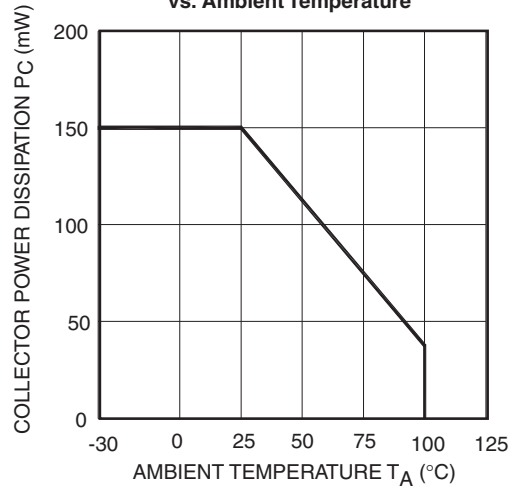

Fig. 3 Collector-Emitter Saturation Voltage vs. Forward Current

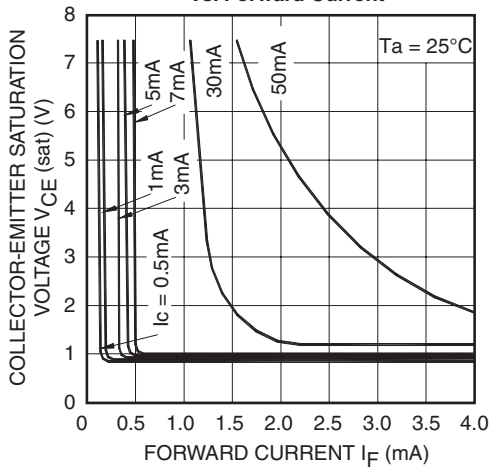

Fig. 4 Forward Current vs. Forward Voltage

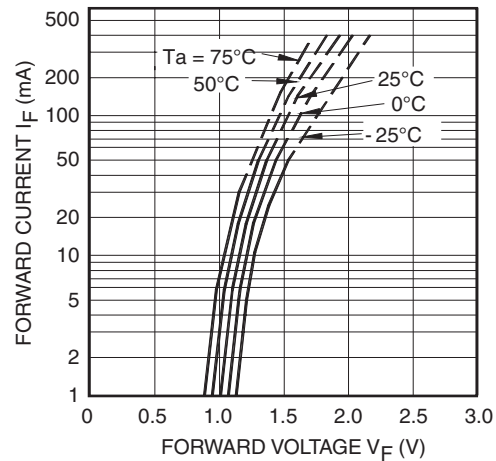

Fig. 5 Current Transfer Ratio vs. Forward Current

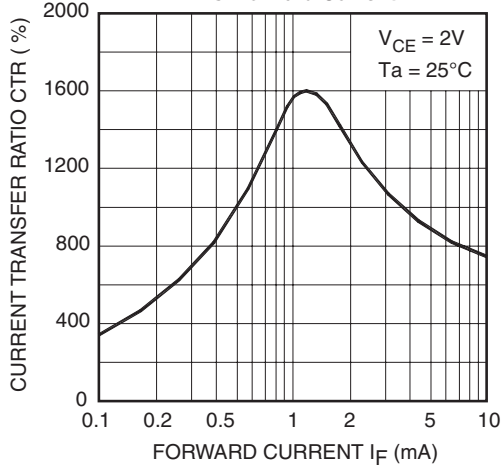
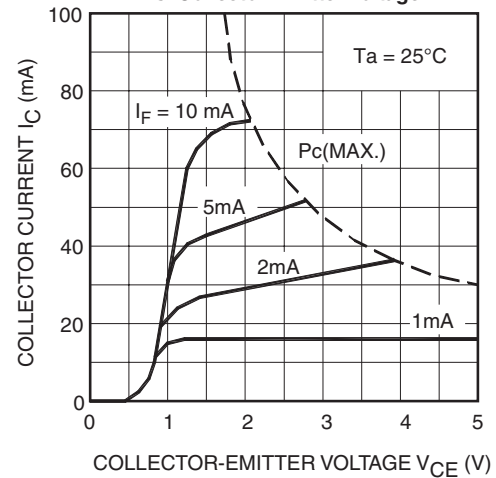

Fig. 6 Collector Current vs. Collector-Emitter Voltage



Typical Electrical/Optical Characteristic Curves ($T_A = 25^\circ\text{C}$ Unless otherwise specified.)

Fig. 7. Relative Current Transfer Ratio vs. Ambient Temperature

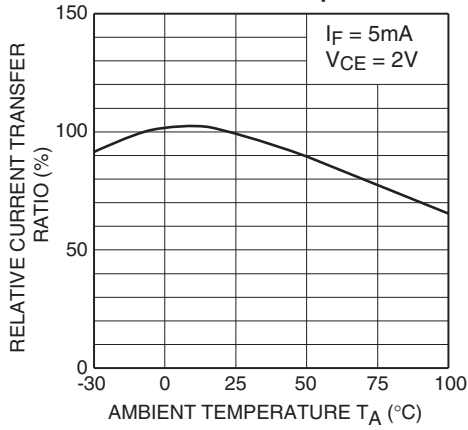

Fig. 8 Collector-Emitter Saturation Voltage vs. Ambient Temperature

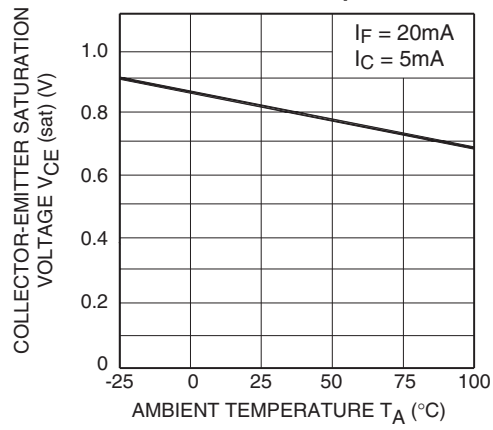

Fig. 9 Collector Dark Current vs. Ambient Temperature

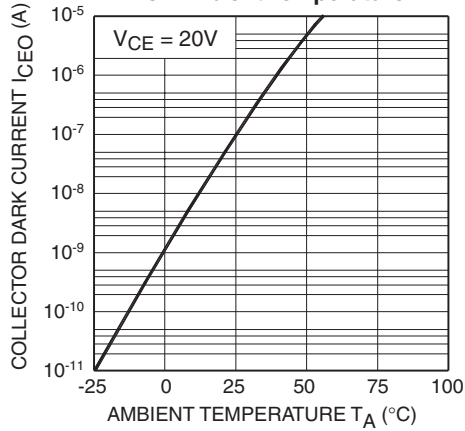

Fig. 10. Response Time vs. Load Resistance

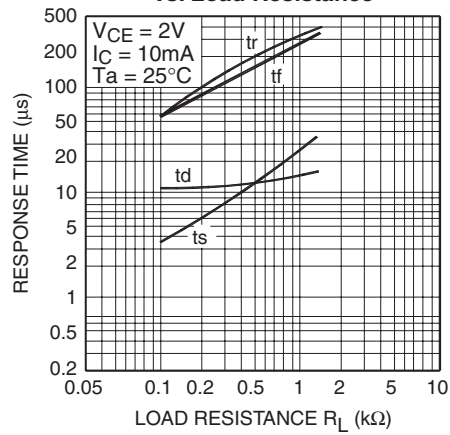
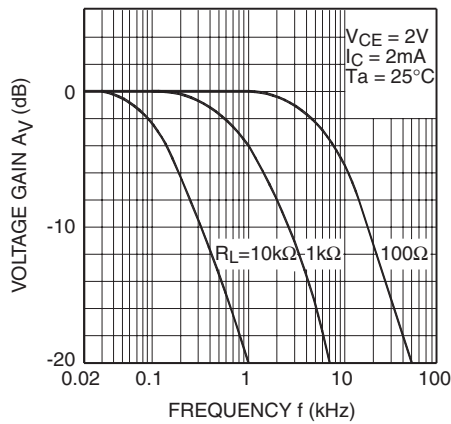
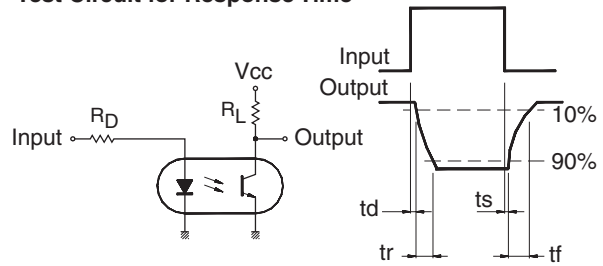

Fig. 11. Frequency Response



Test Circuit for Response Time



Test Circuit for Frequency Response

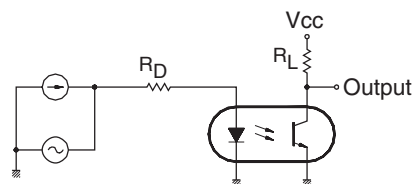

Package Dimensions (Through Hole)

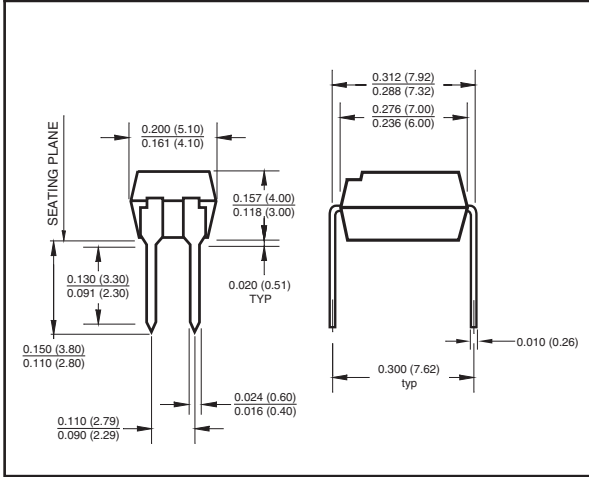

Package Dimensions (Surface Mount)

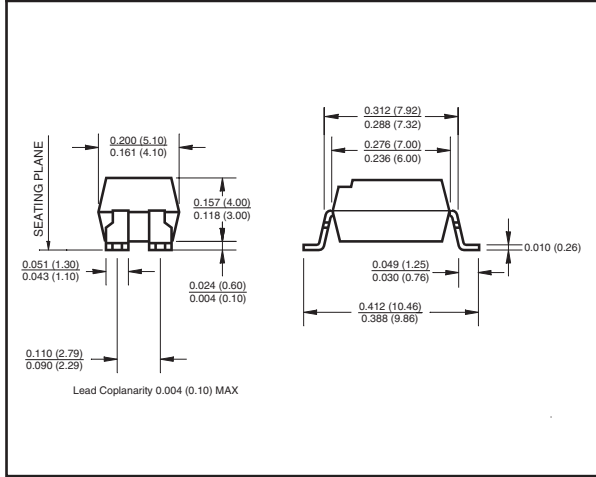

Package Dimensions (0.4" Lead Spacing)

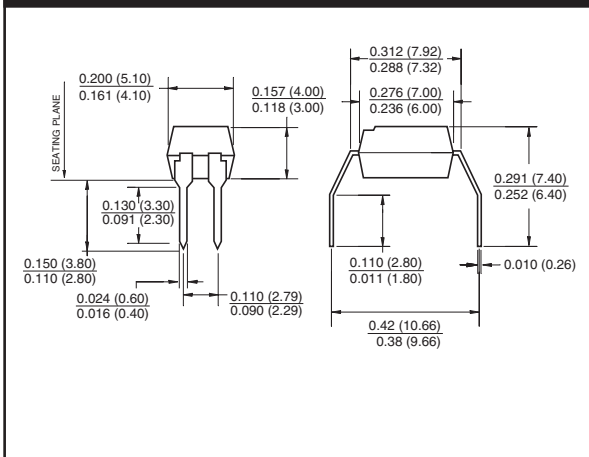

Footprint Dimensions (Surface Mount)

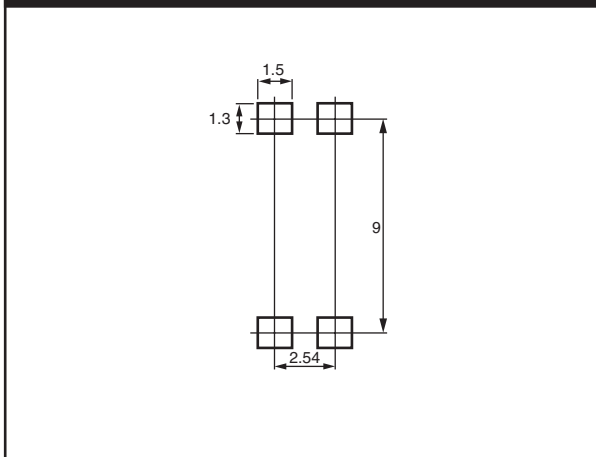

NOTE

All dimensions are in inches (millimeters)

Ordering Information

Option	Order Entry Identifier	Description
S	.S	Surface Mount Lead Bend
SD	.SD	Surface Mount; Tape and reel
W	.W	0.4" Lead Spacing
300	.300	VDE Approved
300W	.300W	VDE Approved, 0.4" Lead Spacing
3S	.3S	VDE Approved, Surface Mount
3SD	.3SD	VDE Approved, Surface Mount, Tape & Reel

Marking Information

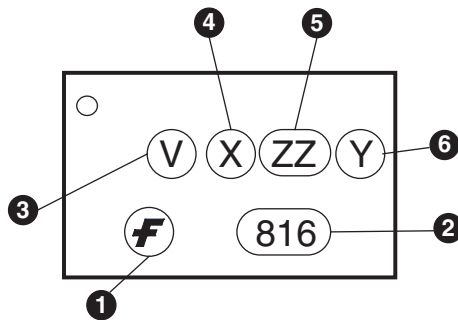

Definitions	
1	Fairchild logo
2	Device number
3	VDE mark (Note: Only appears on parts ordered with VDE option – See order entry table)
4	One digit year code
5	Two digit work week ranging from '01' to '53'
6	Assembly package code

Carrier Tape Specifications

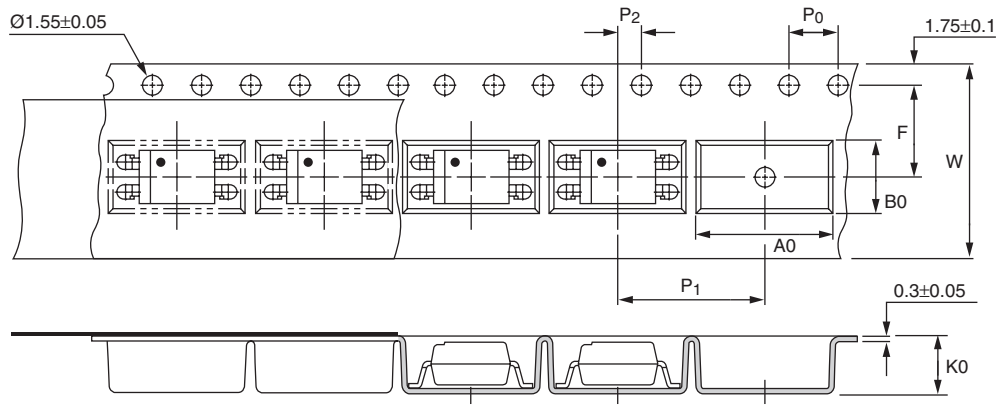

NOTE

All dimensions are in millimeters

Description	Symbol	Dimensions in mm (inches)
Tape wide	W	16 ± 0.3 (.63)
Pitch of sprocket holes	P ₀	4 ± 0.1 (.15)
Distance of compartment	F	7.5 ± 0.1 (.295)
	P ₂	2 ± 0.1 (.079)
Distance of compartment to compartment	P ₁	12 ± 0.1 (.472)
Compartment	A ₀	10.45 ± 0.1 (.411)
	B ₀	5.30 ± 0.1 (.209)
	K ₀	4.25 ± 0.1 (.167)

Lead Free recommended IR Reflow condition

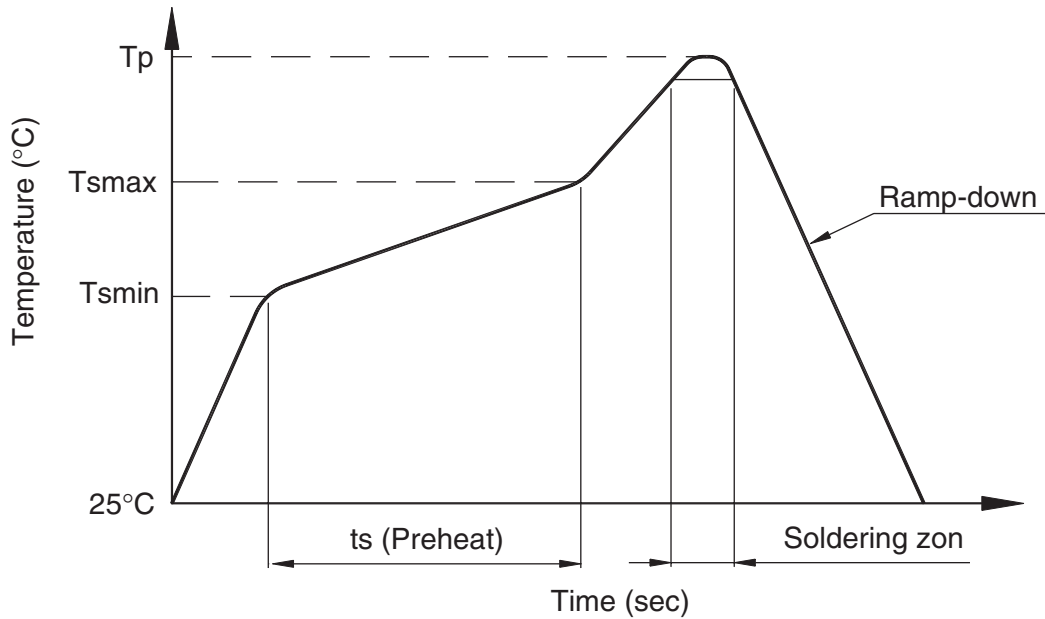

Profile Feature	Pb-Sn solder assembly	Lead Free assembly
Preheat condition (Tsmmin-Tsmmax / ts)	100°C ~ 150°C 60 ~ 120 sec	150°C ~ 200°C 60 ~ 120 sec
Melt soldering zone	183°C 60 ~ 120 sec	217°C 30 ~ 90 sec
Peak temperature (Tp)	240 +0/-5°C	250 +0/-5°C
Ramp-down rate	6°C/sec max.	6°C/sec max.

Recommended Wave Soldering condition

Profile Feature	For all solder assembly
Peak temperature (Tp)	Max 260°C for 10 sec

The following are registered and unregistered trademarks Fairchild Semiconductor owns or is authorized to use and is not intended to be an exhaustive list of all such trademarks.

ACEx™	FAST®	ISOPLANAR™	PowerSaver™	SuperSOT™-8
ActiveArray™	FASTr™	LittleFET™	PowerTrench®	SyncFET™
Bottomless™	FPS™	MICROCOUPLER™	QFET®	TinyLogic®
Build it Now™	FRFET™	MicroFET™	QS™	TINYOPTO™
CoolFET™	GlobalOptoisolator™	MicroPak™	QT Optoelectronics™	TruTranslation™
CROSSVOLT™	GTO™	MICROWIRE™	Quiet Series™	UHC™
DOMET™	HiSeC™	MSX™	RapidConfigure™	UltraFET®
EcoSPARK™	I ² C™	MSXPro™	RapidConnect™	UniFET™
E ² CMOS™	i-Lo™	OCX™	μSerDes™	VCX™
EnSigna™	ImpliedDisconnect™	OCXPro™	SILENT SWITCHER®	Wire™
FACT™	IntelliMAX™	OPTOLOGIC®	SMART START™	
FACT Quiet Series™		OPTOPLANAR™	SPM™	
Across the board. Around the world.™		PACMAN™	Stealth™	
The Power Franchise®		POP™	SuperFET™	
Programmable Active Droop™		Power247™	SuperSOT™-3	
		PowerEdge™	SuperSOT™-6	

DISCLAIMER

FAIRCHILD SEMICONDUCTOR RESERVES THE RIGHT TO MAKE CHANGES WITHOUT FURTHER NOTICE TO ANY PRODUCTS HEREIN TO IMPROVE RELIABILITY, FUNCTION OR DESIGN. FAIRCHILD DOES NOT ASSUME ANY LIABILITY ARISING OUT OF THE APPLICATION OR USE OF ANY PRODUCT OR CIRCUIT DESCRIBED HEREIN; NEITHER DOES IT CONVEY ANY LICENSE UNDER ITS PATENT RIGHTS, NOR THE RIGHTS OF OTHERS.

LIFE SUPPORT POLICY

FAIRCHILD'S PRODUCTS ARE NOT AUTHORIZED FOR USE AS CRITICAL COMPONENTS IN LIFE SUPPORT DEVICES OR SYSTEMS WITHOUT THE EXPRESS WRITTEN APPROVAL OF FAIRCHILD SEMICONDUCTOR CORPORATION. As used herein:

- | | |
|---|---|
| <p>1. Life support devices or systems are devices or systems which, (a) are intended for surgical implant into the body, or (b) support or sustain life, or (c) whose failure to perform when properly used in accordance with instructions for use provided in the labeling, can be reasonably expected to result in significant injury to the user.</p> | <p>2. A critical component is any component of a life support device or system whose failure to perform can be reasonably expected to cause the failure of the life support device or system, or to affect its safety or effectiveness.</p> |
|---|---|

PRODUCT STATUS DEFINITIONS

Definition of Terms

Datasheet Identification	Product Status	Definition
Advance Information	Formative or In Design	This datasheet contains the design specifications for product development. Specifications may change in any manner without notice.
Preliminary	First Production	This datasheet contains preliminary data, and supplementary data will be published at a later date. Fairchild Semiconductor reserves the right to make changes at any time without notice in order to improve design.
No Identification Needed	Full Production	This datasheet contains final specifications. Fairchild Semiconductor reserves the right to make changes at any time without notice in order to improve design.
Obsolete	Not In Production	This datasheet contains specifications on a product that has been discontinued by Fairchild semiconductor. The datasheet is printed for reference information only.

Rev. I16

Home >> Find products >>

FOD816

AC Input, Darlington Output 4-pin DIP

Contents

- [General description](#)
- [Features](#)
- [Applications](#)
- [Product status/pricing/packageing](#)
- [Order Samples](#)
- [Safety agency certificates](#)
- [Qualification Support](#)

General description

The FOD816 consists of two gallium arsenide infrared emitting diodes, connected in inverse parallel, driving a silicon photodarlington output in a 4-pin dual in-line package.

[back to top](#)

Features

- AC input response
- Applicable to Pb-free IR reflow soldering
- Compact 4-pin package
- High current transfer ratio: 600% minimum
- Safety agency approvals pending
- High input-output isolation voltage of 5000Vrms

[back to top](#)

Applications

- Power supply regulators
- Digital logic inputs
- Microprocessor inputs

[back to top](#)

[Product status/pricing/packageing](#)

BUY

BUY

Datasheet

[Download this datasheet](#)



[e-mail this datasheet](#)



This page

[Print version](#)

Related Links

[Request samples](#)

[How to order products](#)







[Product Change Notices \(PCNs\)](#)

[Support](#)

[Sales support](#)

[Quality and reliability](#)

[Design center](#)

Product	Product status	Pb-free Status	Pricing*	Package type	Leads	Packing method
FOD816	Full Production	 Full Production	\$0.257	DIP-B	4	BOX
FOD816300	Full Production	 Full Production	\$0.257	DIP-B	4	BOX
FOD816300W	Full Production	 Full Production	\$0.257	DIP-B	4	BOX
FOD8163S	Full Production	 Full Production	\$0.257	DIP-B	4	BOX
FOD8163SD	Full Production	 Full Production	\$0.286	SMDIP-B	4	TAPE REEL
FOD816S	Full Production	 Full Production	\$0.257	SMDIP-B	4	BOX
FOD816SD	Full Production	 Full Production	\$0.286	SMDIP-B	4	TAPE REEL
FOD816W	Full Production	 Full Production	\$0.257	DIP-B	4	BOX

* Fairchild 1,000 piece Budgetary Pricing

** A sample button will appear if the part is available through Fairchild's on-line samples program. If there is no sample button, please contact a [Fairchild distributor](#) to obtain samples



Indicates product with Pb-free second-level interconnect. For more information [click here](#).

[back to top](#)

Safety agency certificates

Certificate	Agency	
512040 (4502 K)	SEMKO	SEMKO
P05204910 (406 K)	NEMKO	NEMKO
FI 21978 (208 K)	FIMKO	FIMKO
313540-02 (199 K)	DEMKO	DEMKO Testing & Certification
E90700, Vol. 3 (1632 K)	UL (1577)	Underwriters Laboratories Inc.
E90700, Vol. 3 (1632 K)	C-UL	Underwriters Laboratories Inc.
40011272 (334 K)	VDE	VDE Prüf-und Zertifizierungsinstitut

[back to top](#)

Qualification Support

Click on a product for detailed qualification data

Product
FOD816
FOD816300
FOD816300W
FOD8163S
FOD8163SD
FOD816S
FOD816SD
FOD816W

[back to top](#)

© 2007 Fairchild Semiconductor

