

SERIES: AE15B-UW | DESCRIPTION: DC-DC CONVERTER
FEATURES

- up to 15 W isolated output
- ultra-wide 7.5:1 input voltage range, 200~1,500 V
- 5,600 Vdc isolation
- input reverse polarity and under voltage protection
- output over-voltage, over current, and short circuit protection
- reinforced insulation
- PCB, chassis and DIN-rail mounting styles available
- EN 62109 certified
- meets UL 1714, CSA C22.2 No. 107.1



MODEL	input voltage	output voltage	output current	output power	ripple & noise ¹	efficiency ²
	range (Vdc)	nom (Vdc)	max (A)	max (W)	max (mVp-p)	typ (%)
AE15B-UW-S5	200~1500	5	2.0	10	150	64
AE15B-UW-S12	200~1500	12	1.25	15	150	71
AE15B-UW-S15	200~1500	15	1.0	15	150	80
AE15B-UW-S24	200~1500	24	0.625	15	150	83

Notes: 1. Measured at nominal input, 20 MHz bandwidth oscilloscope, with 10 μ F electrolytic and 1 μ F ceramic capacitors on the output.
 2. Measured at 800 Vdc input voltage, full load.
 3. All specifications are measured at $T_a=25^\circ\text{C}$, humidity < 75%, nominal input voltage, and rated output load unless otherwise specified.

PART NUMBER KEY
AE15B-UW - SXX - XXX

Base Number

Output Voltage

 Mounting Style:
 "blank" = board mount
 T = chassis mount
 DIN = DIN-rail mount

INPUT

parameter	conditions/description	min	typ	max	units
operating input voltage	transient (10s)	200	800	1,500 1,600	Vdc Vdc
under voltage shutdown	shut-down range turn-on range	130 155		175 200	Vdc Vdc
current	at 200 Vdc at 800 Vdc at 1,500 Vdc			120 30 16	mA mA mA
inrush current	at 200 Vdc at 1,500 Vdc		30 90		A A
reverse input voltage protection	yes				
input fuse	4 A / 1,500 Vdc (external), required				

OUTPUT

parameter	conditions/description	min	typ	max	units
maximum capacitive load	5 Vdc output model 12 Vdc output model 15 Vdc output model 24 Vdc output model			6,000 2,000 1,200 470	μ F μ F μ F μ F
total accuracy			± 2		%
line regulation	full load		± 1		%
load regulation	from 0% to full load		± 1		%
start-up time ⁴	200 ~ 1,500 Vdc			2	s
hold-up time	at full load, 25°C, 800 Vdc input		20		ms
switching frequency			65		kHz
temperature coefficient			± 0.02	± 0.15	%/°C

Note: 4. Tested at full voltage input range, full output load range. (The cooling time between input power-off and power-on again is greater than 15s.)

PROTECTIONS

parameter	conditions/description	min	typ	max	units
over voltage protection	5 Vdc output model 12 & 15 Vdc output models 24 Vdc output model			8 20 30	Vdc Vdc Vdc
over current protection	auto recovery	120			%
short circuit protection	continuous, auto recovery				

SAFETY AND COMPLIANCE

parameter	conditions/description	min	typ	max	units
isolation voltage	input to output for 1 minute, 3 mA max	5,600			Vdc
safety approvals	certified to 62109-1: EN, BS EN				
conducted emissions	CISPR32/EN55032 Class A (see Fig. 2 for recommended circuit)				
radiated emissions	CISPR32/EN55032 Class A (see Fig. 2 for recommended circuit)				
ESD	IEC/EN61000-4-2 Contact +/-6KV/ Air +/-8KV, perf. Criteria B				
radiated immunity	IEC/EN61000-4-3 10V/m, perf. Criteria B				
EFT/burst	IEC/EN61000-4-4 +/- 2KV, +/-4KV (see Fig. 2 for recommended circuit), perf. Criteria B				
surge	IEC/EN61000-4-5 line to line +/-1KV, IEC/EN61000-4-5 line to line +/-2KV (see Fig. 2 for recommended circuit), perf. Criteria B				
conducted immunity	IEC/EN 61000-4-6 10Vr.m.s, perf. Criteria A				
MTBF	as per MIL-HDBK-217F, 25°C	300,000			hours
RoHS	yes				

ENVIRONMENTAL

parameter	conditions/description	min	typ	max	units
operating temperature	see derating curves	-40		70	°C
storage temperature		-40		85	°C
storage humidity	non-condensing			95	%
altitude	see derating curves			5,000	m

SOLDERABILITY

parameter	conditions/description	min	typ	max	units
hand soldering	for 3~5 seconds	350	360	370	°C
wave soldering	for 5~10 seconds	255	260	265	°C

MECHANICAL

parameter	conditions/description	min	typ	max	units
dimensions	board mount: 89.00 x 63.50 x 25.00 [3.503 x 2.500 x 0.984 inch] chassis mount: 135.00 x 70.00 x 33.50 [5.314 x 2.755 x 1.319 inch] din-rail mount: 135.00 x 70.00 x 39.00 [5.314 x 2.755 x 1.535 inch]				mm
case material	black flame-retardant heat-resistant plastic (UL94V-0)				
weight	board mount chassis mount din-rail mount		200 280 350		g
cooling	natural convection				

MECHANICAL DRAWING

Board mount

units: mm [inch]

tolerance: ± 0.50 [± 0.020]pin diameter tolerance: ± 0.10 [± 0.004]

PIN CONNECTIONS	
PIN	Function
1	-Vin
2	+Vin
3	NC
4	-Vout
5	+Vout

NC=no connection

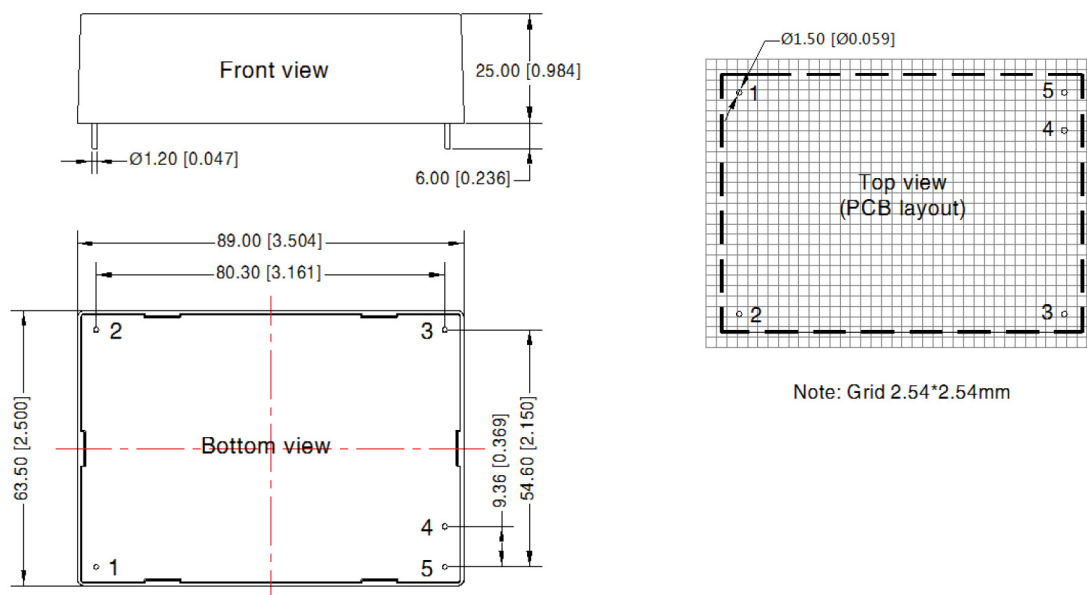

MECHANICAL DRAWING (CONTINUED)

Chassis mount

units: mm [inch]
 wire range: 24-12 AWG
 general tolerance: $\pm 1.00[\pm 0.040]$
 tightening torque: Max 0.4 N·m

PIN CONNECTIONS	
PIN	Function
1	-Vin
2	NC
3	+Vin
4	NC
5	NC
6	NC
7	-Vout
8	+Vout

NC=no connection

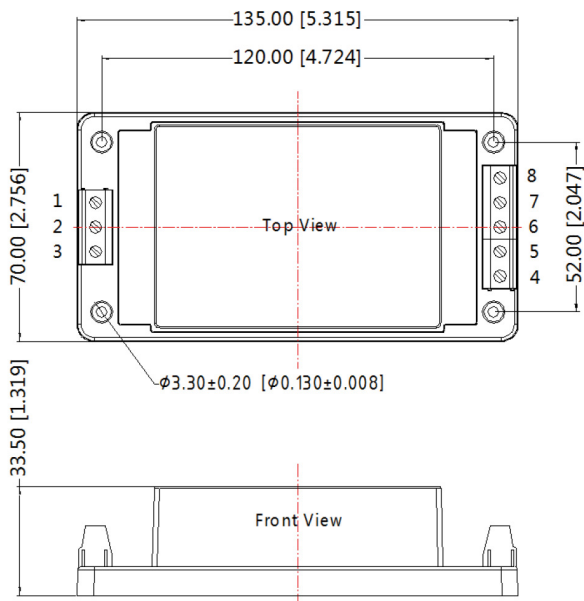

Din-rail mount

units: mm [inch]
 wire range: 24-12 AWG
 tightening torque: Max 0.4 N·m
 mounting rail: TS35, rail needs to connect safety ground
 tolerance: $\pm 1.00[\pm 0.040]$

PIN CONNECTIONS	
PIN	Function
1	-Vin
2	NC
3	+Vin
4	NC
5	NC
6	NC
7	-Vout
8	+Vout

NC=no connection

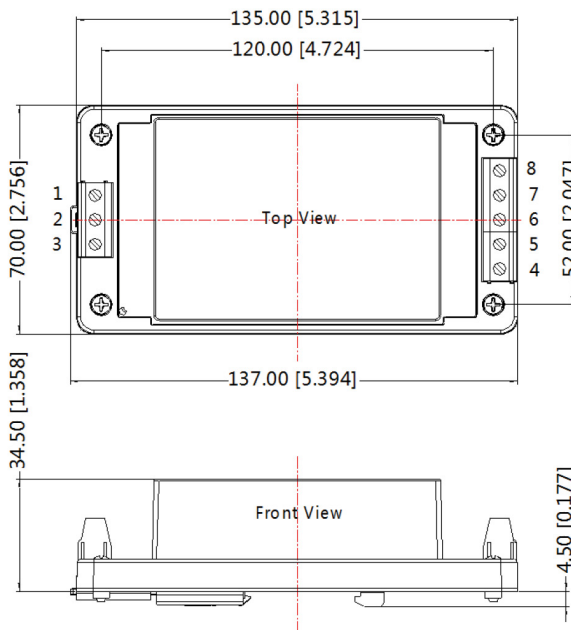

DERATING CURVES

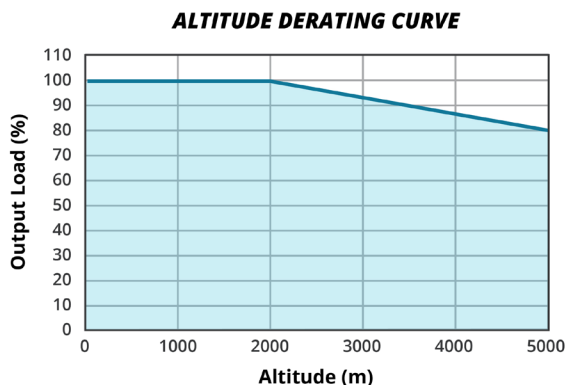
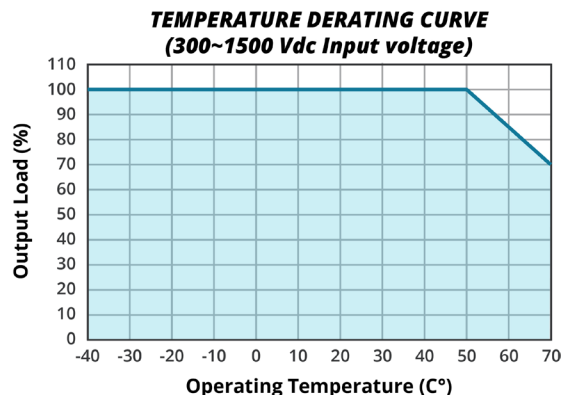
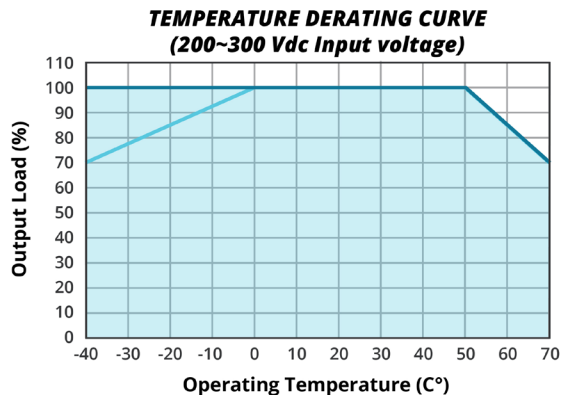

Note: 5. For operation of this converter series in an altitude between 2000 - 5000m above sea level, the output power must be derated as per the altitude derating curve.
6. This product is suitable for applications using natural air cooling; for applications in closed environment please contact CUI.

EFFICIENCY CURVES

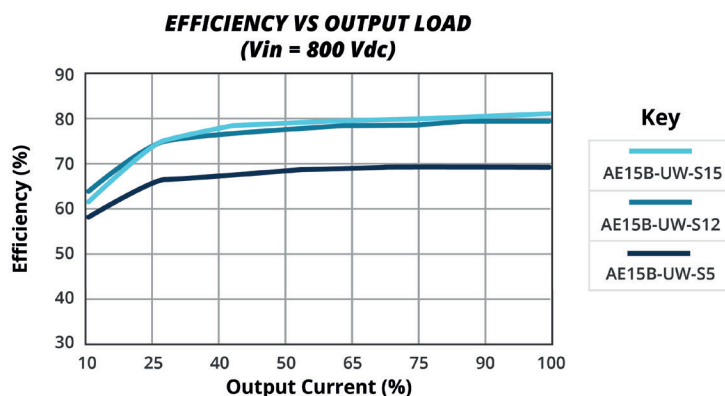
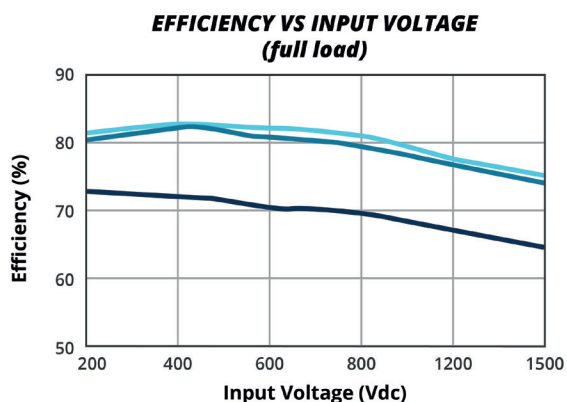

APPLICATION CIRCUIT

Figure 1

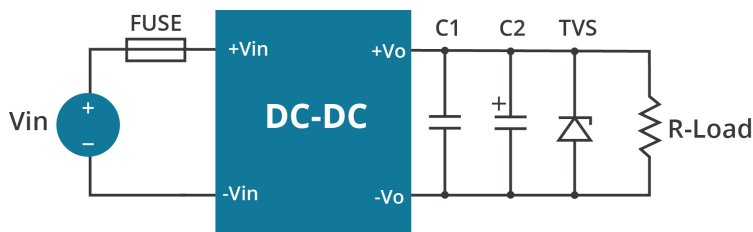

Table 1

Vout (Vdc)	Fuse	C1 (μF/V)	C2 (μF/V)	TVS
5	4 A / 1500 Vdc, required	1 μF/35V	120 μF/35V	SMBJ7.0A
12			120 μF/35V	SMBJ20A
15			120 μF/35V	SMBJ20A
24			68 μF/35V	SMBJ30A

We recommend using an electrolytic capacitor with high frequency and low ESR rating for C2 (refer to manufacture’s datasheet). Choose a capacitor voltage rating with at least 20% margin, in other words not exceeding 80%. C1 is a ceramic capacitor, used to filter high-frequency noise. TVS is a recommended suppressor diode to protect the application in case of a converter failure.

EMC RECOMMENDED CIRCUIT

Figure 2

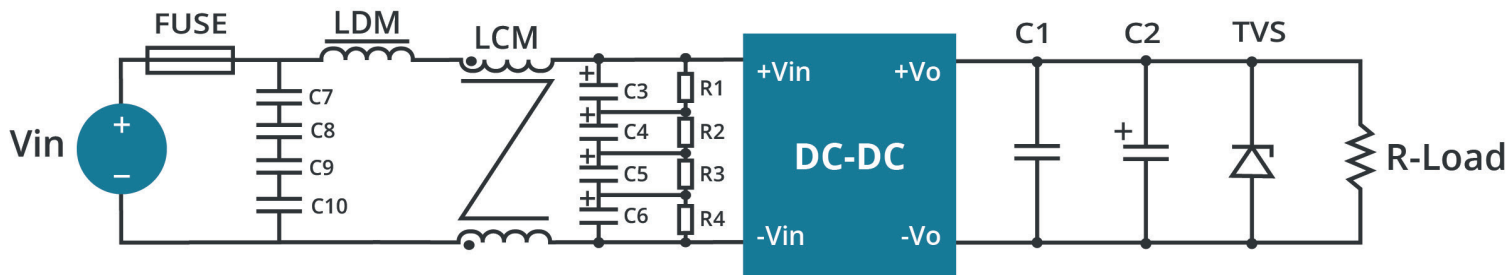

Table 2

Recommended External Circuit Components	
C7, C8, C9, C10	safety capacitor 104K/275 Vac
C3, C4, C5, C6	10 μF/450 Vdc
R1, R2, R3, R4	1 MΩ/2 W
LDM	330 μH/1 A
LCM	7 mH/1 A
FUSE	4 A/1500 Vdc, required

Note: See also Table 1.

REVISION HISTORY

rev.	description	date
1.0	initial release	11/22/2022
1.01	features updated	12/14/2022

The revision history provided is for informational purposes only and is believed to be accurate.



CUI INC
a bel group

Headquarters
20050 SW 112th Ave.
Tualatin, OR 97062
800.275.4899

Fax 503.612.2383
cui.com
techsupport@cui.com

CUI offers a two (2) year limited warranty. Complete warranty information is listed on our website.

CUI reserves the right to make changes to the product at any time without notice. Information provided by CUI is believed to be accurate and reliable. However, no responsibility is assumed by CUI for its use, nor for any infringements of patents or other rights of third parties which may result from its use.

CUI products are not authorized or warranted for use as critical components in equipment that requires an extremely high level of reliability. A critical component is any component of a life support device or system whose failure to perform can be reasonably expected to cause the failure of the life support device or system, or to affect its safety or effectiveness.