

FAMILY OF MICROPOWER RAIL-TO-RAIL OUTPUT OPERATIONAL AMPLIFIERS

FEATURES

- **BiMOS Rail-to-Rail Output**
- **Input Bias Current . . . 1 pA**
- **High Wide Bandwidth . . . 160 kHz**
- **High Slew Rate . . . 0.1 V/μs**
- **Supply Current . . . 7 μA (per channel)**
- **Input Noise Voltage . . . 89 nV/√Hz**
- **Supply Voltage Range . . . 2.7 V to 16 V**
- **Specified Temperature Range**
 - **–40°C to 125°C . . . Industrial Grade**
 - **0°C to 70°C . . . Commercial Grade**
- **Ultra-Small Packaging**
 - **5 Pin SOT-23 (TLV27L1)**

APPLICATIONS

- **Portable Medical**
- **Power Monitoring**
- **Low Power Security Detection Systems**
- **Smoke Detectors**

DESCRIPTION

The TLV27Lx single supply operational amplifiers provide rail-to-rail output capability. The TLV27Lx takes the minimum operating supply voltage down to 2.7 V over the extended industrial temperature range, while adding the rail-to-rail output swing feature. The TLV27Lx also provides 160-kHz bandwidth from only 7 μA. The maximum recommended supply voltage is 16 V, which allows the devices to be operated from (±8-V supplies down to ±1.35 V) two rechargeable cells.

The rail-to-rail outputs make the TLV27Lx good upgrades for the TLC27Lx family—offering more bandwidth at a lower quiescent current. The TLV27Lx offset voltage is equal to that of the TLC27LxA variant. Their cost effectiveness makes them a good alternative to the TLC/V225x, where offset and noise are not of premium importance.

The TLV27L1/2 are available in the commercial temperature range to enable easy migration from the equivalent TLC27Lx. The TLV27L1 is not available with the power saving/performance boosting programmable pin 8.

The TLV27L1 is available in the small SOT-23 package—something the TLC27(L)1 was not—enabling performance boosting in a smaller package. The TLV27L2 is available in the 3mm x 5mm MSOP, providing PCB area savings over the 8-pin SOIC and 8-pin TSSOP.

SELECTION GUIDE

DEVICE	V _S [V]	I _Q /ch [μA]	V _{ICR} [V]	V _{IO} [mV]	I _{IB} [pA]	GBW [MHz]	SLEW RATE [V/μs]	V _n , 1 kHz [nV/√Hz]
TLV27Lx	2.7 to 16	11	–0.2 to V _S +1.2	5	60	0.18	0.06	89
TLV238x	2.7 to 16	10	–0.2 to V _S –0.2	4.5	60	0.18	0.06	90
TLC27Lx	4 to 16	17	–0.2 to V _S –1.5	10/5/2	60	0.085	0.03	68
OPAx349	1.8 to 5.5	2	–0.2 to V _S +0.2	10	10	0.070	0.02	300
OPAx347	2.3 to 5.5	34	–0.2 to V _S +0.2	6	10	0.35	0.01	60
TLC225x	2.7 to 16	62.5	0 to V _S –1.5	1.5/0.85	60	0.200	0.02	19

NOTE: All dc specs are maximums while ac specs are typicals.



Please be aware that an important notice concerning availability, standard warranty, and use in critical applications of Texas Instruments semiconductor products and disclaimers thereto appears at the end of this data sheet.

PRODUCTION DATA information is current as of publication date. Products conform to specifications per the terms of Texas Instruments standard warranty. Production processing does not necessarily include testing of all parameters.

PACKAGE/ORDERING INFORMATION

PRODUCT	PACKAGE	PACKAGE CODE	SYMBOL	SPECIFIED TEMPERATURE RANGE	ORDER NUMBER	TRANSPORT MEDIA
TLV27L1CD	SOIC-8	D	27V1C	0°C to 70°C	TLV27L1CD	Tube
					TLV27L1CDR	Tape and Reel
TLV27L1CDBV	SOT-23	DBV	VBIC		TLV27L1CDBVR	Tape and Reel
					TLV27L1CDBVT	
TLV27L1ID	SOIC-8	D	27V1I	-40°C to 125°C	TLV27L1ID	Tube
					TLV27L1IDR	Tape and Reel
TLV27L1IDBV	SOT-23	DBV	VBII		TLV27L1IDBVR	Tape and Reel
					TLV27L1IDBVT	
TLV27L2CD	SOIC-8	D	27V2C	0°C to 70°C	TLV27L2CD	Tube
					TLV27L2CDR	Tape and Reel
TLV27L2ID	SOIC-8	D	27V2I	-40°C to 125°C	TLV27L2ID	Tube
					TLV27L2IDR	Tape and Reel

absolute maximum ratings over operating free-air temperature (unless otherwise noted)†

Supply voltage, V_S	16.5 V
Input voltage, V_I (see Note 1)	V_S
Output current, I_O	100 mA
Differential input voltage, V_{ID}	V_S
Continuous total power dissipation	See Dissipation Rating Table
Maximum junction temperature, T_J	150°C
Operating free-air temperature range, T_A : C suffix	0°C to 70°C
	I suffix
Storage temperature range, T_{stg}	-65°C to 125°C
Lead temperature 1,6 mm (1/16 inch) from case for 10 seconds	300°C

† Stresses beyond those listed under “absolute maximum ratings” may cause permanent damage to the device. These are stress ratings only, and functional operation of the device at these or any other conditions beyond those indicated under “recommended operating conditions” is not implied. Exposure to absolute-maximum-rated conditions for extended periods may affect device reliability.

NOTE 1: Relative to GND pin.

DISSIPATION RATING TABLE

PACKAGE	θ_{JC} (°C/W)	θ_{JA} (°C/W)	$T_A \leq 25^\circ\text{C}$ POWER RATING	$T_A = 85^\circ\text{C}$ POWER RATING
D (8)	38.3	176	710 mW	370 mW
DBV (5)	55	324.1	385 mW	201 mW
DBV (6)	55	294.3	425 mW	221 mW

recommended operating conditions

		MIN	MAX	UNIT
Supply voltage, (V_S)	Dual supply	±1.35	±8	V
	Single supply	2.7	16	
Input common-mode voltage range		-0.2	$V_S - 1.2$	V
Operating free-air temperature, T_A	C-suffix	0	70	°C
	I-suffix	-40	125	

electrical characteristics at recommended operating conditions, $V_S = 2.7\text{ V}$, 5 V , and 10 V (unless otherwise noted)

dc performance

PARAMETER		TEST CONDITIONS	T_A^\dagger	MIN	TYP	MAX	UNIT	
V_{IO}	Input offset voltage	$V_{IC} = V_S/2,$ $R_L = 100\text{ k}\Omega,$	$V_O = V_S/2,$ $R_S = 50\ \Omega$	25°C	0.5	5	mV	
				Full range		7		
α_{VIO}	Offset voltage drift		25°C		1.1		$\mu\text{V}/^\circ\text{C}$	
CMRR	Common-mode rejection ratio	$V_{IC} = 0\text{ V to }V_S-1.2\text{ V},$ $R_S = 50\ \Omega$	25°C	71	86		dB	
			Full range	70				
A_{VD}	Large-signal differential voltage amplification	$V_{O(PP)} = V_S/2,$ $R_L = 100\text{ k}\Omega$	$V_S = 2.7\text{ V},$ 5 V	25°C	80	100		dB
				Full range	77			
			$V_S = \pm 5\text{ V}$	25°C	77	82		
				Full range	74			

† Full range is -40°C to 125°C for I suffix.

input characteristics

PARAMETER		TEST CONDITIONS	T_A	MIN	TYP	MAX	UNIT
I_{IO}	Input offset current	$V_{IC} = V_S/2,$ $R_L = 100\text{ k}\Omega,$	$V_O = V_S/2,$ $R_S = 50\ \Omega$	$\leq 25^\circ\text{C}$	1	60	pA
				$\leq 70^\circ\text{C}$		100	
				$\leq 125^\circ\text{C}$		1000	
I_{IB}	Input bias current	$V_{IC} = V_S/2,$ $R_L = 100\text{ k}\Omega,$	$V_O = V_S/2,$ $R_S = 50\ \Omega$	$\leq 25^\circ\text{C}$	1	60	pA
				$\leq 70^\circ\text{C}$		200	
				$\leq 125^\circ\text{C}$		1000	
$r_{i(d)}$	Differential input resistance		25°C		1000		G Ω
C_{IC}	Common-mode input capacitance	$f = 1\text{ kHz}$	25°C		8		pF

power supply

PARAMETER		TEST CONDITIONS	T_A^\dagger	MIN	TYP	MAX	UNIT
I_Q	Quiescent current (per channel)	$V_O = V_S/2$	25°C		7	11	μA
			Full range			16	
PSRR	Power supply rejection ratio ($\Delta V_S/\Delta V_{IO}$)	$V_S = 2.7\text{ V to }16\text{ V},$ $V_{IC} = V_S/2\text{ V}$	No load,	25°C	74	82	dB
				Full range	70		

† Full range is -40°C to 125°C for I suffix.

electrical characteristics at recommended operating conditions, $V_S = 2.7\text{ V}$, 5 V , and $\pm 5\text{ V}$ (unless otherwise noted) (continued)

output characteristics

PARAMETER		TEST CONDITIONS		T_A^\dagger	MIN	TYP	MAX	UNIT
V_O	Output voltage swing from rail	$V_{IC} = V_S/2$, $I_{OL} = 100\ \mu\text{A}$	$V_S = 2.7\text{ V}$	25°C	160	200	mV	
				Full range	220			
			$V_S = 5\text{ V}$	25°C	85	120		
				Full range	200			
			$V_S = \pm 5\text{ V}$	25°C	50	120		
				Full range	150			
		$V_{IC} = V_S/2$, $I_{OL} = 500\ \mu\text{A}$	$V_S = 5\text{ V}$	25°C	420	800		
				Full range	900			
$V_S = \pm 5\text{ V}$	25°C	200	400					
	Full range	500						
I_O	Output current	$V_O = 0.5\text{ V}$ from rail	$V_S = 2.7\text{ V}$	25°C	400		μA	

† Full range is -40°C to 125°C for I suffix.

dynamic performance

PARAMETER		TEST CONDITIONS		T_A	MIN	TYP	MAX	UNIT
GBP	Gain bandwidth product	$R_L = 100\ \text{k}\Omega$, $C_L = 10\ \text{pF}$, $f = 1\ \text{kHz}$		25°C		160		kHz
SR	Slew rate at unity gain	$V_{O(pp)} = 1\ \text{V}$, $R_L = 100\ \text{k}\Omega$, $C_L = 50\ \text{pF}$		25°C		0.06		V/ μs
				-40°C		0.05		
				125°C		0.8		
ϕ_M	Phase margin	$R_L = 100\ \text{k}\Omega$, $C_L = 50\ \text{pF}$		25°C		62		$^\circ$
t_s	Settling time (0.1%)	$V_{(STEP)pp} = 1\ \text{V}$, $A_V = -1$, $C_L = 50\ \text{pF}$, $R_L = 100\ \text{k}\Omega$	Rise	25°C		62		μs
			Fall			44		

noise/distortion performance

PARAMETER		TEST CONDITIONS		T_A	MIN	TYP	MAX	UNIT
V_n	Equivalent input noise voltage	$f = 1\ \text{kHz}$		25°C		89		nV/ $\sqrt{\text{Hz}}$
I_n	Equivalent input noise current	$f = 1\ \text{kHz}$		25°C		0.6		fA/ $\sqrt{\text{Hz}}$

TYPICAL CHARACTERISTICS

Table of Graphs

			FIGURE	
V_{IO}	Input offset voltage	vs Common-mode input voltage	1, 2, 3	
I_{IB}/I_{IO}	Input bias and offset current	vs Free-air temperature	4	
V_{OH}	High-level output voltage	vs High-level output current	5, 7, 9	
V_{OL}	Low-level output voltage	vs Low-level output current	6, 8, 10	
I_Q	Quiescent current	vs Supply voltage	11	
		vs Free-air temperature	12	
Supply voltage and supply current ramp up			13	
A_{VD}	Differential voltage gain and phase shift	vs Frequency	14	
GBP	Gain-bandwidth product	vs Free-air temperature	15	
ϕ_m	Phase margin	vs Load capacitance	16	
CMRR	Common-mode rejection ratio	vs Frequency	17	
PSRR	Power supply rejection ratio	vs Frequency	18	
		Input referred noise voltage	vs Frequency	19
SR	Slew rate	vs Free-air temperature	20	
$V_{O(PP)}$	Peak-to-peak output voltage	vs Frequency	21	
		Inverting small-signal response	22	
		Inverting large-signal response	23	
Crosstalk			vs Frequency	24

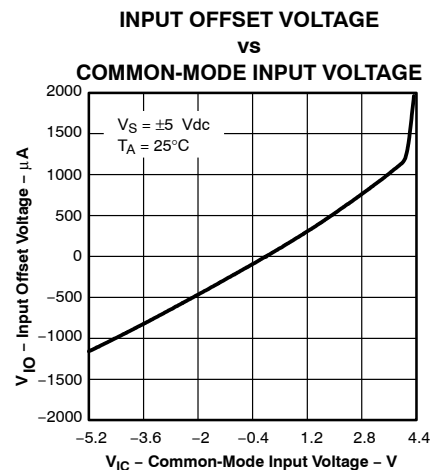
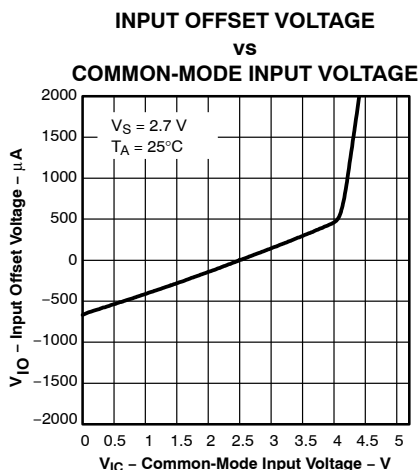
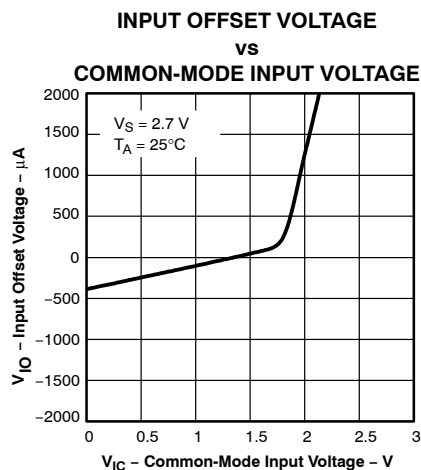

TYPICAL CHARACTERISTICS

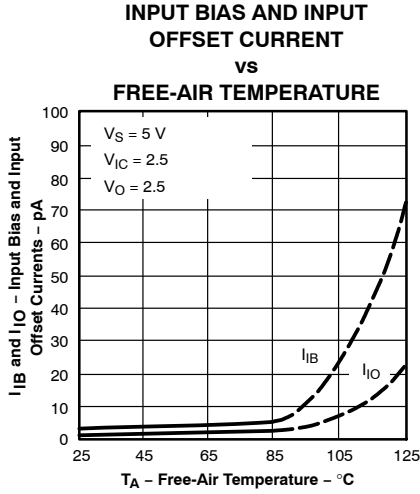

Figure 4

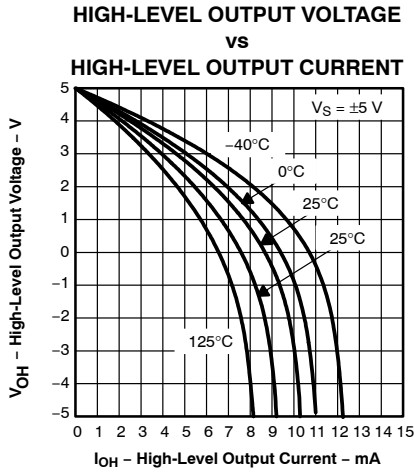

Figure 5

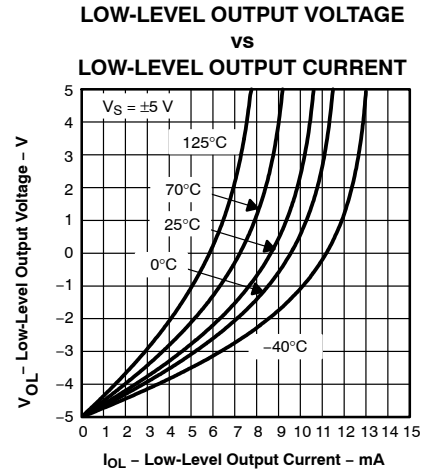

Figure 6

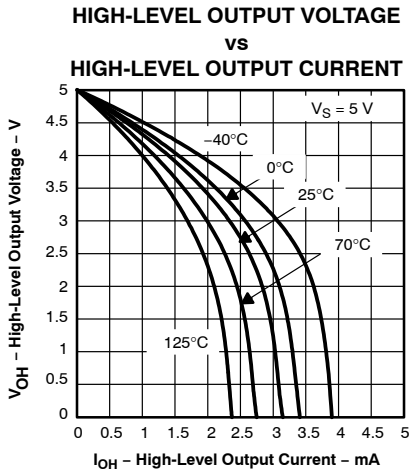

Figure 7

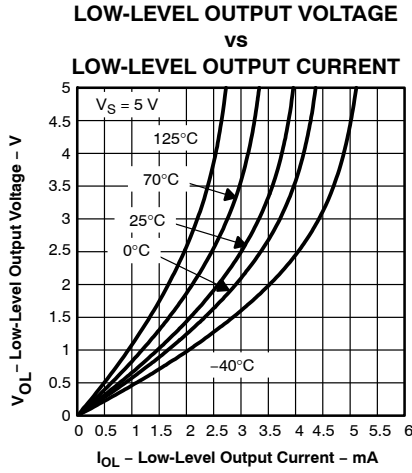

Figure 8

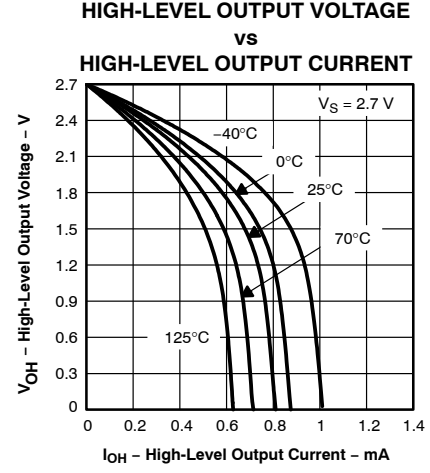

Figure 9

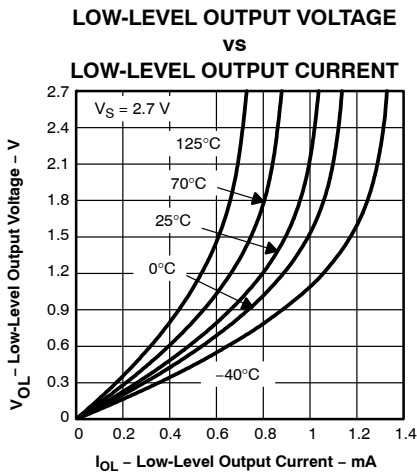

Figure 10

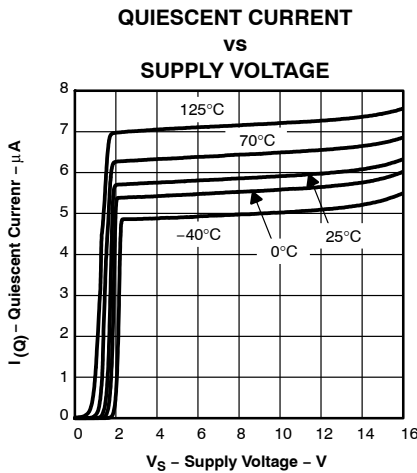

Figure 11

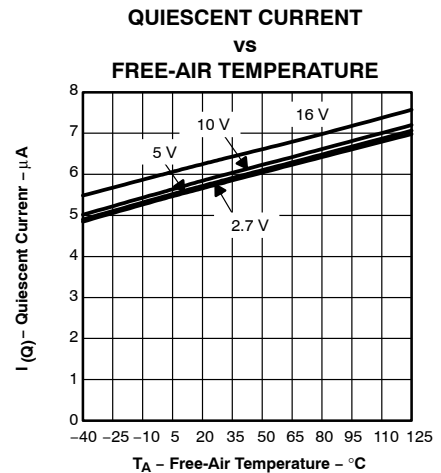

Figure 12

TYPICAL CHARACTERISTICS

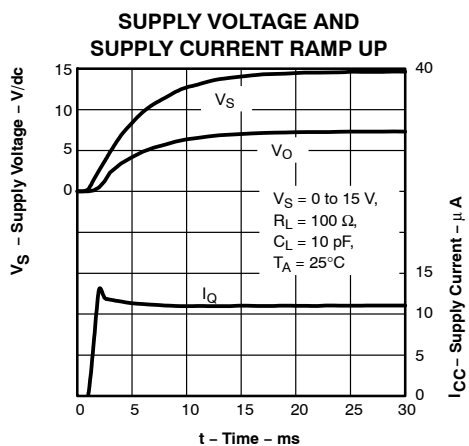

Figure 13

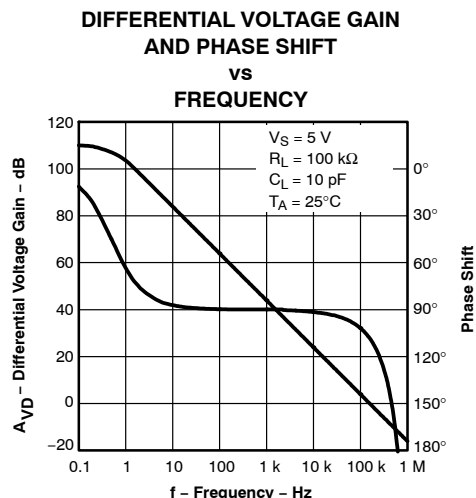

Figure 14

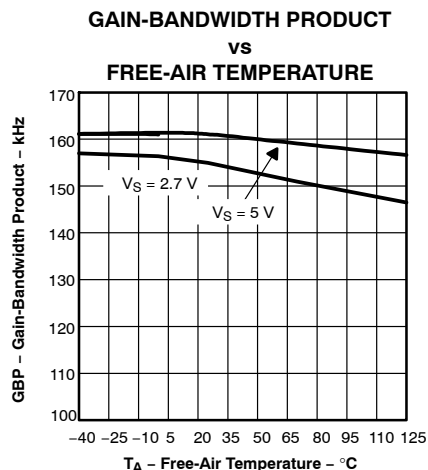

Figure 15

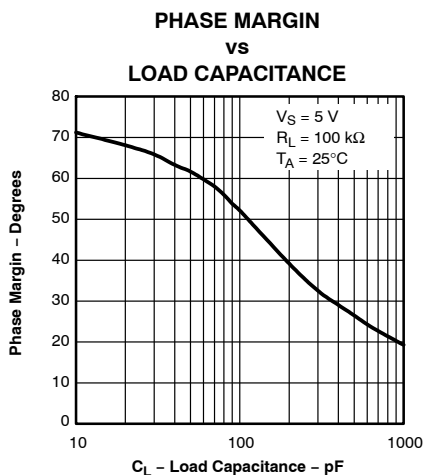

Figure 16

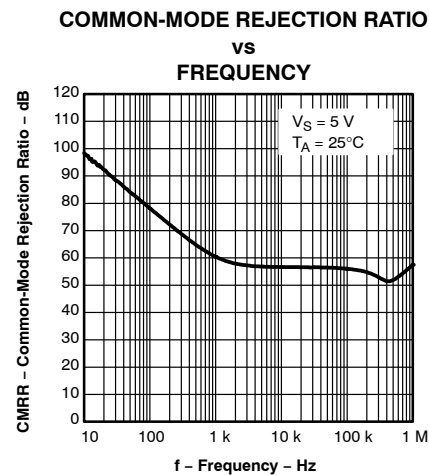

Figure 17

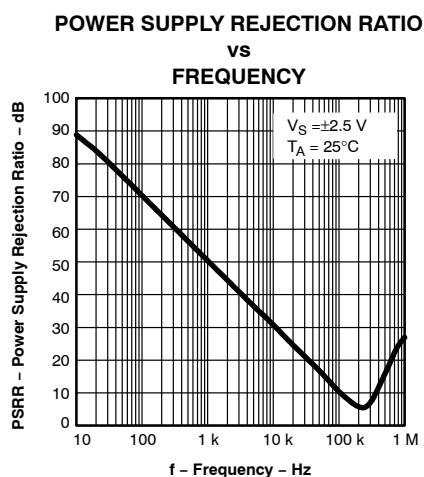

Figure 18

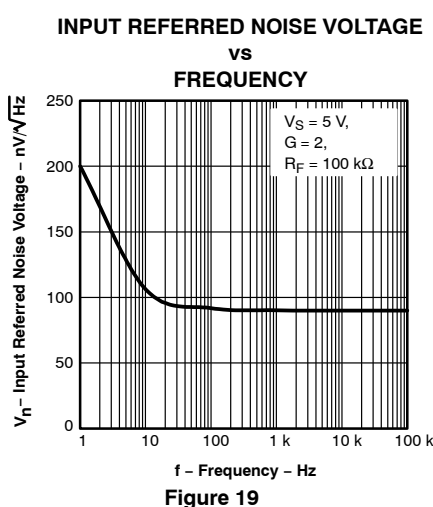

Figure 19

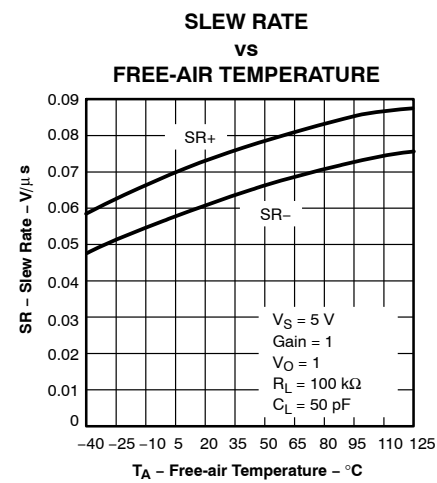
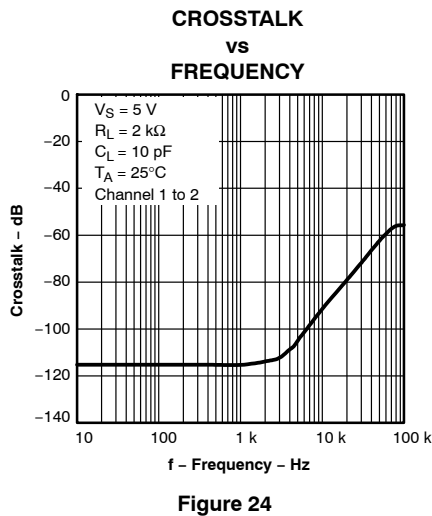
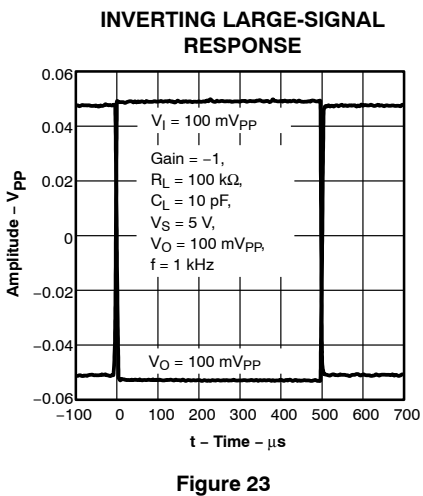
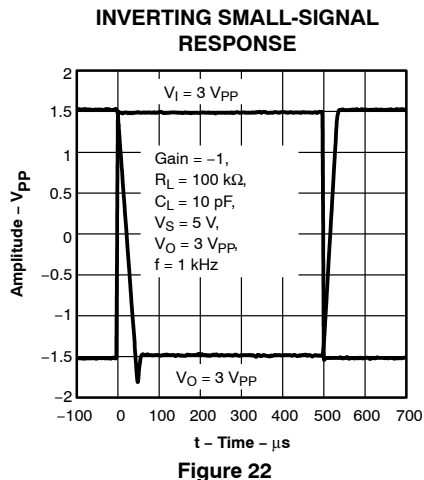
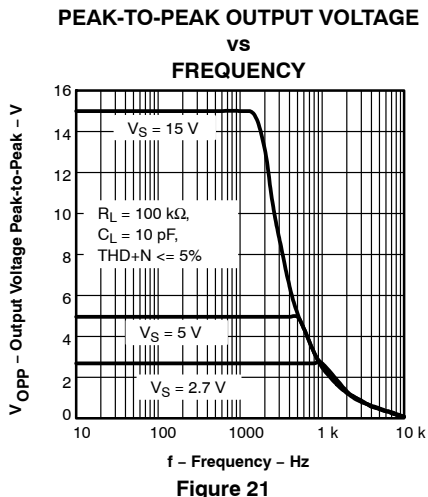

Figure 20

TYPICAL CHARACTERISTICS



APPLICATION INFORMATION

offset voltage

The output offset voltage (V_{OO}) is the sum of the input offset voltage (V_{IO}) and both input bias currents (I_{IB}) times the corresponding gains. The following schematic and formula can be used to calculate the output offset voltage:

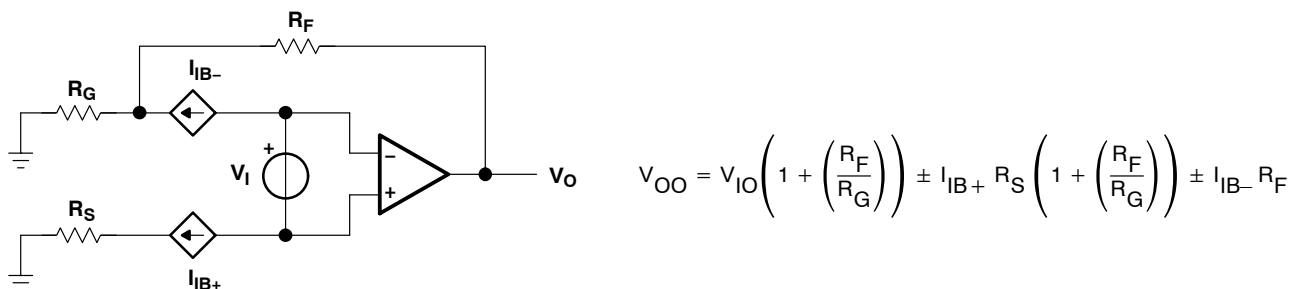

Figure 25. Output Offset Voltage Model

general configurations

When receiving low-level signals, limiting the bandwidth of the incoming signals into the system is often required. The simplest way to accomplish this is to place an RC filter at the noninverting terminal of the amplifier (see Figure 26).

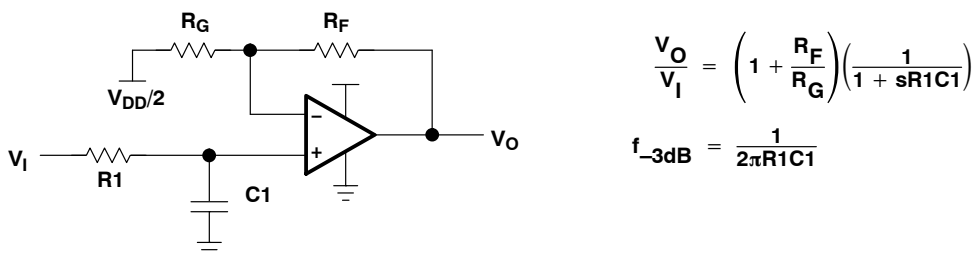

Figure 26. Single-Pole Low-Pass Filter

If even more attenuation is needed, a multiple pole filter is required. The Sallen-Key filter can be used for this task. For best results, the amplifier should have a bandwidth that is 8 to 10 times the filter frequency bandwidth. Failure to do this can result in phase shift of the amplifier.

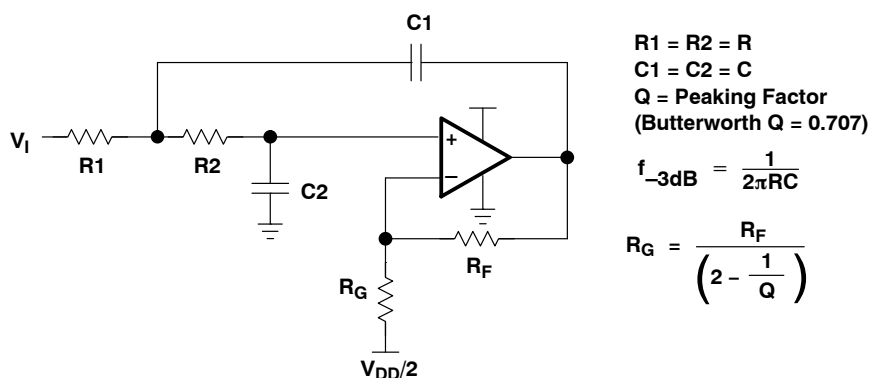

Figure 27. 2-Pole Low-Pass Sallen-Key Filter

APPLICATION INFORMATION

circuit layout considerations

To achieve the levels of high performance of the TLV27Lx, follow proper printed-circuit board design techniques. A general set of guidelines is given in the following.

- Ground planes—It is highly recommended that a ground plane be used on the board to provide all components with a low inductive ground connection. However, in the areas of the amplifier inputs and output, the ground plane can be removed to minimize the stray capacitance.
- Proper power supply decoupling—Use a 6.8- μ F tantalum capacitor in parallel with a 0.1- μ F ceramic capacitor on each supply terminal. It may be possible to share the tantalum among several amplifiers depending on the application, but a 0.1- μ F ceramic capacitor should always be used on the supply terminal of every amplifier. In addition, the 0.1- μ F capacitor should be placed as close as possible to the supply terminal. As this distance increases, the inductance in the connecting trace makes the capacitor less effective. The designer should strive for distances of less than 0.1 inches between the device power terminals and the ceramic capacitors.
- Sockets—Sockets can be used but are not recommended. The additional lead inductance in the socket pins will often lead to stability problems. Surface-mount packages soldered directly to the printed-circuit board is the best implementation.
- Short trace runs/compact part placements—Optimum high performance is achieved when stray series inductance has been minimized. To realize this, the circuit layout should be made as compact as possible, thereby minimizing the length of all trace runs. Particular attention should be paid to the inverting input of the amplifier. Its length should be kept as short as possible. This will help to minimize stray capacitance at the input of the amplifier.
- Surface-mount passive components—Using surface-mount passive components is recommended for high performance amplifier circuits for several reasons. First, because of the extremely low lead inductance of surface-mount components, the problem with stray series inductance is greatly reduced. Second, the small size of surface-mount components naturally leads to a more compact layout thereby minimizing both stray inductance and capacitance. If leaded components are used, it is recommended that the lead lengths be kept as short as possible.

APPLICATION INFORMATION

general power dissipation considerations

For a given θ_{JA} , the maximum power dissipation is shown in Figure 28 and is calculated by the following formula:

$$P_D = \left(\frac{T_{MAX} - T_A}{\theta_{JA}} \right)$$

Where:

- P_D = Maximum power dissipation of TLV27Lx IC (watts)
- T_{MAX} = Absolute maximum junction temperature (150°C)
- T_A = Free-ambient air temperature (°C)
- θ_{JA} = $\theta_{JC} + \theta_{CA}$
- θ_{JC} = Thermal coefficient from junction to case
- θ_{CA} = Thermal coefficient from case to ambient air (°C/W)

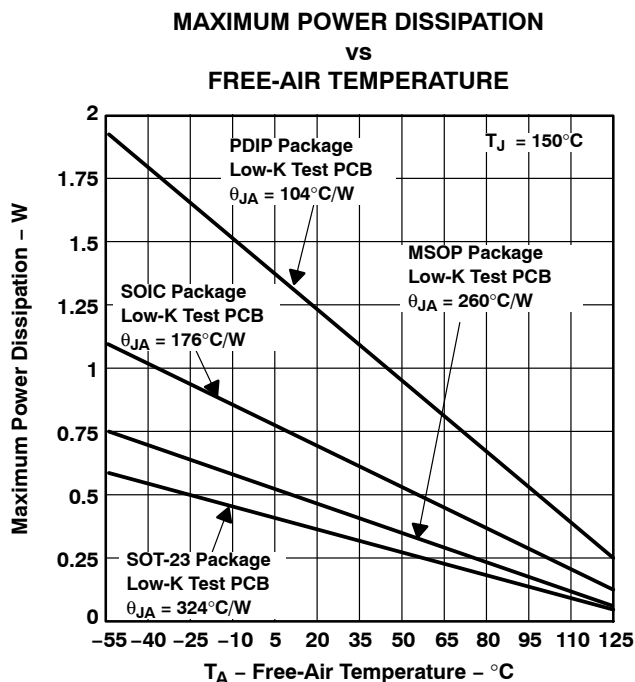

NOTE A: Results are with no air flow and using JEDEC Standard Low-K test PCB.

Figure 28. Maximum Power Dissipation vs Free-Air Temperature

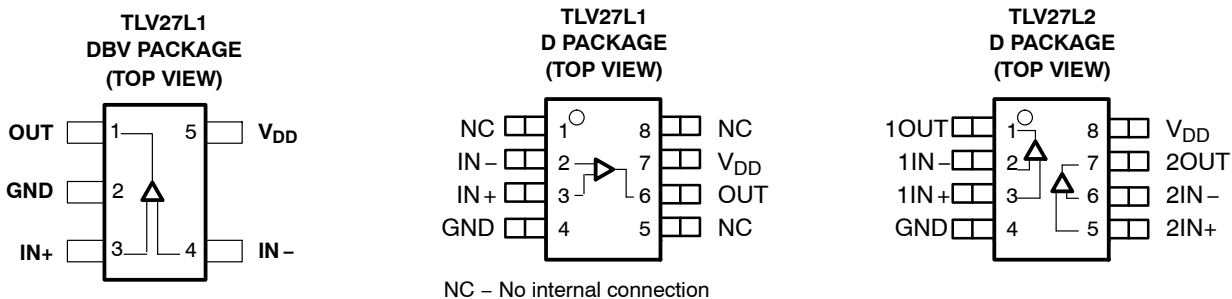

PACKAGING INFORMATION

Orderable Device	Status (1)	Package Type	Package Drawing	Pins	Package Qty	Eco Plan (2)	Lead finish/ Ball material (6)	MSL Peak Temp (3)	Op Temp (°C)	Device Marking (4/5)	Samples
TLV27L1CD	ACTIVE	SOIC	D	8	75	RoHS & Green	NIPDAU	Level-1-260C-UNLIM	0 to 70	27V1C	Samples
TLV27L1CDBVR	ACTIVE	SOT-23	DBV	5	3000	RoHS & Green	NIPDAU	Level-1-260C-UNLIM	0 to 70	VBIC	Samples
TLV27L1CDBVT	ACTIVE	SOT-23	DBV	5	250	RoHS & Green	NIPDAU	Level-1-260C-UNLIM	0 to 70	VBIC	Samples
TLV27L1ID	ACTIVE	SOIC	D	8	75	RoHS & Green	NIPDAU	Level-1-260C-UNLIM	-40 to 125	27V1I	Samples
TLV27L1IDBVR	ACTIVE	SOT-23	DBV	5	3000	RoHS & Green	NIPDAU	Level-1-260C-UNLIM	-40 to 125	VBII	Samples
TLV27L1IDBVRG4	ACTIVE	SOT-23	DBV	5	3000	RoHS & Green	NIPDAU	Level-1-260C-UNLIM	-40 to 125	VBII	Samples
TLV27L1IDBVT	ACTIVE	SOT-23	DBV	5	250	RoHS & Green	NIPDAU	Level-1-260C-UNLIM	-40 to 125	VBII	Samples
TLV27L1IDBVTG4	ACTIVE	SOT-23	DBV	5	250	RoHS & Green	NIPDAU	Level-1-260C-UNLIM	-40 to 125	VBII	Samples
TLV27L1IDR	ACTIVE	SOIC	D	8	2500	RoHS & Green	NIPDAU	Level-1-260C-UNLIM	-40 to 125	27V1I	Samples
TLV27L2CDGK	ACTIVE	VSSOP	DGK	8	80	RoHS & Green	NIPDAU NIPDAUAG	Level-1-260C-UNLIM		BAC	Samples
TLV27L2CDGKR	ACTIVE	VSSOP	DGK	8	2500	RoHS & Green	NIPDAU NIPDAUAG	Level-1-260C-UNLIM		BAC	Samples
TLV27L2CDR	ACTIVE	SOIC	D	8	2500	RoHS & Green	NIPDAU	Level-1-260C-UNLIM	0 to 70	27V2C	Samples
TLV27L2ID	ACTIVE	SOIC	D	8	75	RoHS & Green	NIPDAU	Level-1-260C-UNLIM	-40 to 125	27V2I	Samples
TLV27L2IDGK	ACTIVE	VSSOP	DGK	8	80	RoHS & Green	NIPDAU NIPDAUAG	Level-1-260C-UNLIM		BAD	Samples
TLV27L2IDGKR	ACTIVE	VSSOP	DGK	8	2500	RoHS & Green	NIPDAU NIPDAUAG	Level-1-260C-UNLIM		BAD	Samples
TLV27L2IDR	ACTIVE	SOIC	D	8	2500	RoHS & Green	NIPDAU	Level-1-260C-UNLIM	-40 to 125	27V2I	Samples

(1) The marketing status values are defined as follows:

ACTIVE: Product device recommended for new designs.

LIFEBUY: TI has announced that the device will be discontinued, and a lifetime-buy period is in effect.

NRND: Not recommended for new designs. Device is in production to support existing customers, but TI does not recommend using this part in a new design.

PREVIEW: Device has been announced but is not in production. Samples may or may not be available.

OBSELETE: TI has discontinued the production of the device.

(2) **RoHS:** TI defines "RoHS" to mean semiconductor products that are compliant with the current EU RoHS requirements for all 10 RoHS substances, including the requirement that RoHS substance do not exceed 0.1% by weight in homogeneous materials. Where designed to be soldered at high temperatures, "RoHS" products are suitable for use in specified lead-free processes. TI may reference these types of products as "Pb-Free".

RoHS Exempt: TI defines "RoHS Exempt" to mean products that contain lead but are compliant with EU RoHS pursuant to a specific EU RoHS exemption.

Green: TI defines "Green" to mean the content of Chlorine (Cl) and Bromine (Br) based flame retardants meet JS709B low halogen requirements of ≤ 1000 ppm threshold. Antimony trioxide based flame retardants must also meet the ≤ 1000 ppm threshold requirement.

(3) MSL, Peak Temp. - The Moisture Sensitivity Level rating according to the JEDEC industry standard classifications, and peak solder temperature.

(4) There may be additional marking, which relates to the logo, the lot trace code information, or the environmental category on the device.

(5) Multiple Device Markings will be inside parentheses. Only one Device Marking contained in parentheses and separated by a "~" will appear on a device. If a line is indented then it is a continuation of the previous line and the two combined represent the entire Device Marking for that device.

(6) Lead finish/Ball material - Orderable Devices may have multiple material finish options. Finish options are separated by a vertical ruled line. Lead finish/Ball material values may wrap to two lines if the finish value exceeds the maximum column width.

Important Information and Disclaimer: The information provided on this page represents TI's knowledge and belief as of the date that it is provided. TI bases its knowledge and belief on information provided by third parties, and makes no representation or warranty as to the accuracy of such information. Efforts are underway to better integrate information from third parties. TI has taken and continues to take reasonable steps to provide representative and accurate information but may not have conducted destructive testing or chemical analysis on incoming materials and chemicals. TI and TI suppliers consider certain information to be proprietary, and thus CAS numbers and other limited information may not be available for release.

In no event shall TI's liability arising out of such information exceed the total purchase price of the TI part(s) at issue in this document sold by TI to Customer on an annual basis.

OTHER QUALIFIED VERSIONS OF TLV27L2 :

- Automotive : [TLV27L2-Q1](#)

NOTE: Qualified Version Definitions:

- Automotive - Q100 devices qualified for high-reliability automotive applications targeting zero defects

TAPE AND REEL INFORMATION

QUADRANT ASSIGNMENTS FOR PIN 1 ORIENTATION IN TAPE

*All dimensions are nominal

Device	Package Type	Package Drawing	Pins	SPQ	Reel Diameter (mm)	Reel Width W1 (mm)	A0 (mm)	B0 (mm)	K0 (mm)	P1 (mm)	W (mm)	Pin1 Quadrant
TLV27L1CDBVR	SOT-23	DBV	5	3000	180.0	9.0	3.15	3.2	1.4	4.0	8.0	Q3
TLV27L1CDBVT	SOT-23	DBV	5	250	180.0	9.0	3.15	3.2	1.4	4.0	8.0	Q3
TLV27L1IDBVR	SOT-23	DBV	5	3000	180.0	9.0	3.15	3.2	1.4	4.0	8.0	Q3
TLV27L1IDBVT	SOT-23	DBV	5	250	180.0	9.0	3.15	3.2	1.4	4.0	8.0	Q3
TLV27L1IDR	SOIC	D	8	2500	330.0	12.4	6.4	5.2	2.1	8.0	12.0	Q1
TLV27L2CDGKR	VSSOP	DGK	8	2500	330.0	12.4	5.3	3.4	1.4	8.0	12.0	Q1
TLV27L2CDGKR	VSSOP	DGK	8	2500	330.0	12.4	5.3	3.4	1.4	8.0	12.0	Q1
TLV27L2CDR	SOIC	D	8	2500	330.0	12.4	6.4	5.2	2.1	8.0	12.0	Q1
TLV27L2IDGKR	VSSOP	DGK	8	2500	330.0	12.4	5.3	3.4	1.4	8.0	12.0	Q1
TLV27L2IDGKR	VSSOP	DGK	8	2500	330.0	12.4	5.3	3.4	1.4	8.0	12.0	Q1
TLV27L2IDR	SOIC	D	8	2500	330.0	12.4	6.4	5.2	2.1	8.0	12.0	Q1

TAPE AND REEL BOX DIMENSIONS

*All dimensions are nominal

Device	Package Type	Package Drawing	Pins	SPQ	Length (mm)	Width (mm)	Height (mm)
TLV27L1CDBVR	SOT-23	DBV	5	3000	182.0	182.0	20.0
TLV27L1CDBVT	SOT-23	DBV	5	250	182.0	182.0	20.0
TLV27L1IDBVR	SOT-23	DBV	5	3000	182.0	182.0	20.0
TLV27L1IDBVT	SOT-23	DBV	5	250	182.0	182.0	20.0
TLV27L1IDR	SOIC	D	8	2500	340.5	336.1	25.0
TLV27L2CDGKR	VSSOP	DGK	8	2500	358.0	335.0	35.0
TLV27L2CDGKR	VSSOP	DGK	8	2500	364.0	364.0	27.0
TLV27L2CDR	SOIC	D	8	2500	340.5	336.1	25.0
TLV27L2IDGKR	VSSOP	DGK	8	2500	364.0	364.0	27.0
TLV27L2IDGKR	VSSOP	DGK	8	2500	358.0	335.0	35.0
TLV27L2IDR	SOIC	D	8	2500	340.5	336.1	25.0

TUBE

*All dimensions are nominal

Device	Package Name	Package Type	Pins	SPQ	L (mm)	W (mm)	T (μm)	B (mm)
TLV27L1CD	D	SOIC	8	75	507	8	3940	4.32
TLV27L1ID	D	SOIC	8	75	507	8	3940	4.32
TLV27L2CDGK	DGK	VSSOP	8	80	330	6.55	500	2.88
TLV27L2ID	D	SOIC	8	75	507	8	3940	4.32
TLV27L2IDGK	DGK	VSSOP	8	80	330	6.55	500	2.88

DBV0005A



PACKAGE OUTLINE

SOT-23 - 1.45 mm max height

SMALL OUTLINE TRANSISTOR



4214839/F 06/2021

NOTES:

1. All linear dimensions are in millimeters. Any dimensions in parenthesis are for reference only. Dimensioning and tolerancing per ASME Y14.5M.
2. This drawing is subject to change without notice.
3. Reference JEDEC MO-178.
4. Body dimensions do not include mold flash, protrusions, or gate burrs. Mold flash, protrusions, or gate burrs shall not exceed 0.25 mm per side.

EXAMPLE BOARD LAYOUT

DBV0005A

SOT-23 - 1.45 mm max height

SMALL OUTLINE TRANSISTOR



LAND PATTERN EXAMPLE
EXPOSED METAL SHOWN
SCALE:15X



SOLDER MASK DETAILS

4214839/F 06/2021

NOTES: (continued)

- 5. Publication IPC-7351 may have alternate designs.
- 6. Solder mask tolerances between and around signal pads can vary based on board fabrication site.

EXAMPLE STENCIL DESIGN

DBV0005A

SOT-23 - 1.45 mm max height

SMALL OUTLINE TRANSISTOR



SOLDER PASTE EXAMPLE
BASED ON 0.125 mm THICK STENCIL
SCALE:15X

4214839/F 06/2021

NOTES: (continued)

7. Laser cutting apertures with trapezoidal walls and rounded corners may offer better paste release. IPC-7525 may have alternate design recommendations.
8. Board assembly site may have different recommendations for stencil design.



D0008A

PACKAGE OUTLINE

SOIC - 1.75 mm max height

SMALL OUTLINE INTEGRATED CIRCUIT



4214825/C 02/2019

NOTES:

1. Linear dimensions are in inches [millimeters]. Dimensions in parenthesis are for reference only. Controlling dimensions are in inches. Dimensioning and tolerancing per ASME Y14.5M.
2. This drawing is subject to change without notice.
3. This dimension does not include mold flash, protrusions, or gate burrs. Mold flash, protrusions, or gate burrs shall not exceed $.006$ [0.15] per side.
4. This dimension does not include interlead flash.
5. Reference JEDEC registration MS-012, variation AA.

EXAMPLE BOARD LAYOUT

D0008A

SOIC - 1.75 mm max height

SMALL OUTLINE INTEGRATED CIRCUIT



LAND PATTERN EXAMPLE
 EXPOSED METAL SHOWN
 SCALE:8X



SOLDER MASK DETAILS

4214825/C 02/2019

NOTES: (continued)

- 6. Publication IPC-7351 may have alternate designs.
- 7. Solder mask tolerances between and around signal pads can vary based on board fabrication site.

EXAMPLE STENCIL DESIGN

D0008A

SOIC - 1.75 mm max height

SMALL OUTLINE INTEGRATED CIRCUIT



SOLDER PASTE EXAMPLE
BASED ON .005 INCH [0.125 MM] THICK STENCIL
SCALE:8X

4214825/C 02/2019

NOTES: (continued)

8. Laser cutting apertures with trapezoidal walls and rounded corners may offer better paste release. IPC-7525 may have alternate design recommendations.
9. Board assembly site may have different recommendations for stencil design.

DGK (S-PDSO-G8)

PLASTIC SMALL-OUTLINE PACKAGE



- NOTES:
- A. All linear dimensions are in millimeters.
 - B. This drawing is subject to change without notice.
 - C. Body length does not include mold flash, protrusions, or gate burrs. Mold flash, protrusions, or gate burrs shall not exceed 0.15 per end.
 - D. Body width does not include interlead flash. Interlead flash shall not exceed 0.50 per side.
 - E. Falls within JEDEC MO-187 variation AA, except interlead flash.



- NOTES:
- A. All linear dimensions are in millimeters.
 - B. This drawing is subject to change without notice.
 - C. Publication IPC-7351 is recommended for alternate designs.
 - D. Laser cutting apertures with trapezoidal walls and also rounding corners will offer better paste release. Customers should contact their board assembly site for stencil design recommendations. Refer to IPC-7525 for other stencil recommendations.
 - E. Customers should contact their board fabrication site for solder mask tolerances between and around signal pads.

IMPORTANT NOTICE AND DISCLAIMER

TI PROVIDES TECHNICAL AND RELIABILITY DATA (INCLUDING DATA SHEETS), DESIGN RESOURCES (INCLUDING REFERENCE DESIGNS), APPLICATION OR OTHER DESIGN ADVICE, WEB TOOLS, SAFETY INFORMATION, AND OTHER RESOURCES "AS IS" AND WITH ALL FAULTS, AND DISCLAIMS ALL WARRANTIES, EXPRESS AND IMPLIED, INCLUDING WITHOUT LIMITATION ANY IMPLIED WARRANTIES OF MERCHANTABILITY, FITNESS FOR A PARTICULAR PURPOSE OR NON-INFRINGEMENT OF THIRD PARTY INTELLECTUAL PROPERTY RIGHTS.

These resources are intended for skilled developers designing with TI products. You are solely responsible for (1) selecting the appropriate TI products for your application, (2) designing, validating and testing your application, and (3) ensuring your application meets applicable standards, and any other safety, security, regulatory or other requirements.

These resources are subject to change without notice. TI grants you permission to use these resources only for development of an application that uses the TI products described in the resource. Other reproduction and display of these resources is prohibited. No license is granted to any other TI intellectual property right or to any third party intellectual property right. TI disclaims responsibility for, and you will fully indemnify TI and its representatives against, any claims, damages, costs, losses, and liabilities arising out of your use of these resources.

TI's products are provided subject to [TI's Terms of Sale](#) or other applicable terms available either on ti.com or provided in conjunction with such TI products. TI's provision of these resources does not expand or otherwise alter TI's applicable warranties or warranty disclaimers for TI products.

TI objects to and rejects any additional or different terms you may have proposed.

Mailing Address: Texas Instruments, Post Office Box 655303, Dallas, Texas 75265
Copyright © 2022, Texas Instruments Incorporated