

# SMR Evaluation Kit User Manual

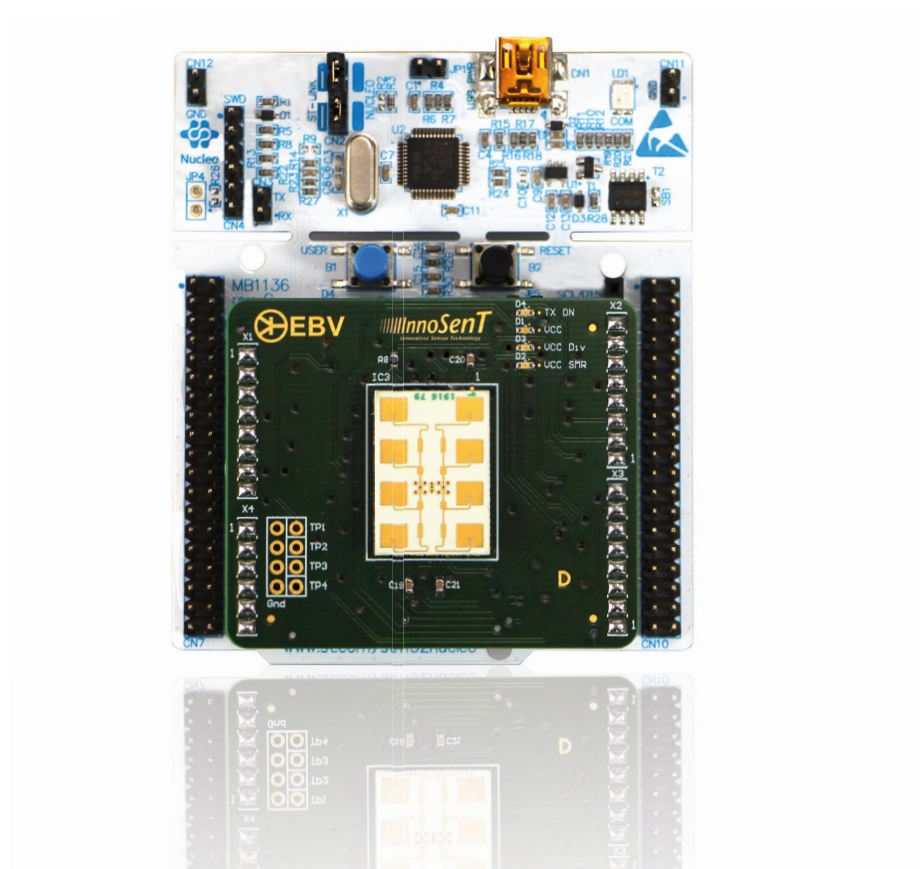

## Content

Introduction	3
Installation	4
Brief Introduction to Radar Principles	6
Getting Started	11
Radar configurable parameters	19
Data Transmission	20
Signal Processing	22
Frequency Auto-Calibration	22
Complete Application Diagram	24
Hardware	25
References	28
History	28

## 1. Introduction

### Overview

The Evaluation Kit "EVALKIT SMR-334" is a programmable compact radar system with a focus on creating a friendly and easy-to-use FMCW radar platform. It comes with a custom and open firmware that provides beginners with an easy way to experience radar sensors in their application and take a look into the signal processing with our detailed examples.

The SMR-Eval Kit is built around the SMR sensor family and comes equipped with our flagship module SMR-334. The underlying STM32F401RE Nucleo Board from ST provides the necessary processing power and interface to the IDE and GUI. The kit comes with all necessary hardware, software and documentation to quickly start evaluating innovative radar technology.

### Features

- Supports Doppler and FMCW radar principle
- VCO controlled with 16-bit DAC on the SMR interface module
- Stereo receiver
- 12bit data acquisition
- Configurable Doppler frequency and FMCW bandwidth
- Frequency auto-calibration for compliance with government regulations
- Simple GUI to visualize receive signals
- ADC raw data and FFT display
- Configurable radar parameters for advanced users
  - Bandwidth
  - ADC sampling rate
  - Frequency auto-calibration enable
  - Etc.
- Full SMR antenna module control
- System power and communication via a single USB interface
- Source code with detailed comments giving users full control to the Evaluation Kit

## 2. Installation

### Hardware Installation

The SMR-EvalKit packet consists of:

- SMR antenna module
- STM32F401RE-Nucleoboard
- Mini USB cable
- Download link on the InnoSenT Homepage: Project files with Source code, GUI, User Manual, Quickstart Software, SMR Data Sheet)

In order to have a proper hardware installation, please follow the instructions below:

- The SMR Evaluation Kit comes preassembled, however it is also possible to disassemble the two boards.
- When the two boards are separated and need to be assembled, connect them as in the following picture. Note: before connecting the two boards please make sure the power supply to the STM32F401RE board (via USB cable) is disconnected in order to prevent any damage to the system due to wrong connection and the connection should be checked again before applying the power supply.
- Jumpers on the microcontroller board should be left unchanged.

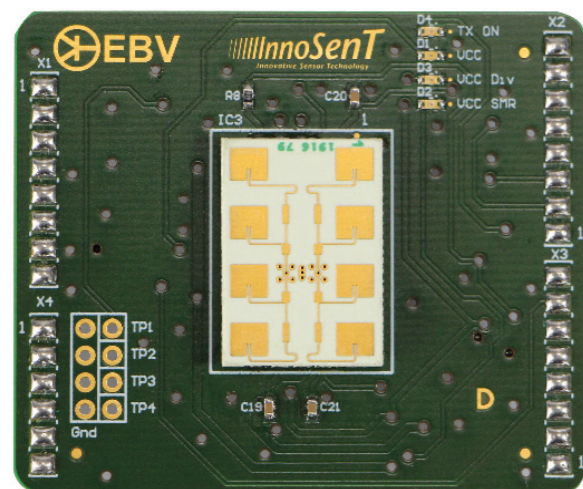

Figure 1: SMR Antenna module

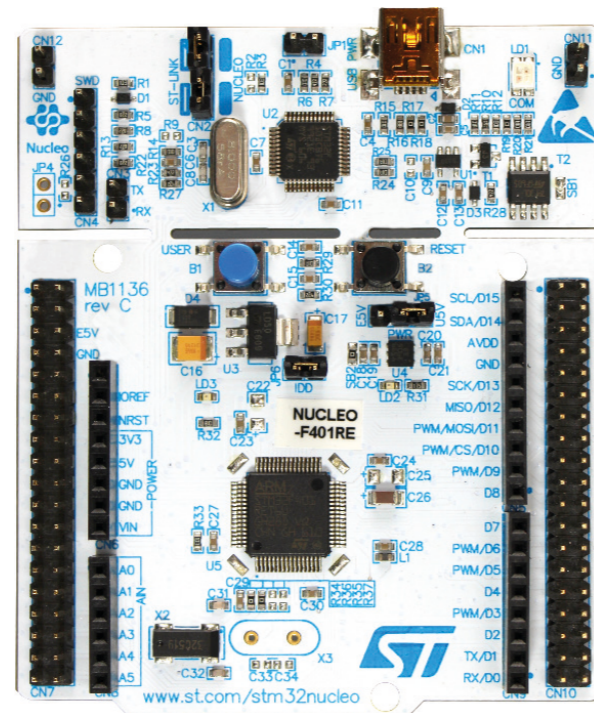

Figure 2: STM32F401RE-Nucleoboard

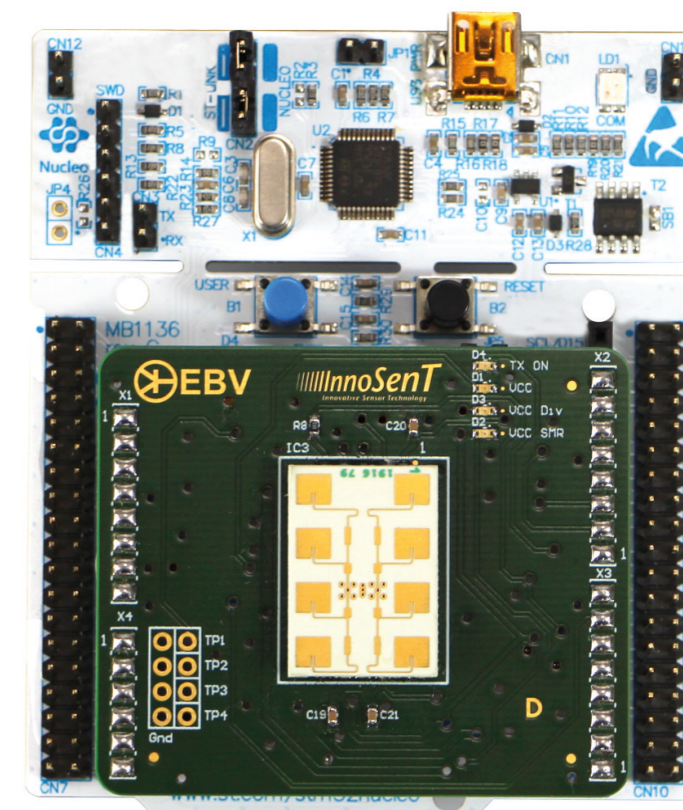

Figure 3: SMR-board and STM32 board connection

### Software Installation

Please refer to the SMR Evaluation Kit quick start guide for instructions about the software installation.

### 3. Brief Introduction to Radar Principles

#### Doppler Principle

##### Basis elements

The CW-Doppler radar is the simplest kind of Radar, but most effective for detecting motion and measuring speed. It utilizes the Doppler Effect, an effect which applies to all sorts of wave generators and says the following:

Wave fronts, transmitted by a wave generator (sound, microwaves, light etc.) hit a moving target. Depending on the direction of the motion of this object, the wave fronts are either "compressed" or "stretched", which finally results in a shift in frequency. The received signal is mixed with the unchanged transmit signal in the receiver (called "homodyne" mixing), which results in a sinusoidal intermediate frequency (IF). It doesn't matter whether the sensor moves relatively to the object or the object moves relatively to the sensor.

As a matter of fact, only the radial component of the velocity vector can be detected. The mathematical formula looks as follows:

$$f_{Doppler} = 2f_0 * \frac{v}{C_0} * \cos\alpha$$

- $f_D$  Doppler- or differential frequency
- $f_0$  Transmit frequency of the radar
- $v$  velocity of the moving object
- $C_0$  Speed of light
- $\alpha$  Angle between the actual direction of motion and the connecting line sensor-object

Selecting 24GHz as transmit frequency, the following rule of thumb applies:

$$f_{Doppler} = 44 \frac{Hz}{km/h} * v * \cos\alpha$$

With this simple equation the expected Doppler frequency can easily be calculated and the parameters of the IF-filter and amplifier can be defined.

For instance it is not practical to design the upper frequency limit of the signal conditioning part of a unit detecting human beings much higher than 300Hz, since this corresponds to a speed of 6.8 km/h of a (pretty fast) pedestrian. On the other hand, when using radar sensors to check the speed of cars for example on a German motorway, the amplifier needs to have an upper frequency limit of at least 10 kHz corresponding to 220 km/h.

As a summary the speed of an object can be evaluated by measuring the Doppler frequency (in an analog system by counting the zero crossings or in digital system by frequency analysis with FFT), while considering the angle of the motion vector.

Please note:

In the very rare case of a perfect circular motion of the object around the sensor, the angle  $\alpha$  would be 90°, which causes the cosine and therefore the Doppler frequency to drop to zero. This specific motion won't be detected by this type of radar. However this object would have to move along this circle with absolute perfection, which is highly unlikely for a real life object.

#### Identification of direction of motion

Radar sensors with dual IF output can provide information about the direction of motion (leaving or approaching) simply by utilizing two mixer circuits, which are spaced by a quarter wavelength, called an I(n phase)/Q(uadrature phase) mixer.

This information is useful for example in door opener applications, where the door should open only when a person approaches it.

For detailed information on the radar basics, see Application\_Note I-IV on the InnoSenT homepage.

#### Example

The calculation of the parameters of the implemented CW-Doppler example is shown below:

speed of light	C0	299792458	m/s
CW-Frequency	F	depending on FREQ_START	Hz
		Example: 24.000	GHz
sampling period	Ta	0.0004	s
		400	µs
buffer length (number of samples)	N	128	
sampling time	Tsample	0.0512	s
		51.2	ms
velocity resolution	Vmin	0.122	m/s
		0.44	km/h
low pass filter (theoretical)	LP	1250	Hz
low pass filter (current hardware)		915	Hz
high pass filter (theoretical)	HP	19.53	Hz
high pass filter (current hardware)		20	Hz

$$\mathbf{T_{sample}} = T_a * N = 400\mu s * 128 = \mathbf{51.2ms}$$

$$\mathbf{V_{min}} = \frac{C_0}{2 * T_{sample} * F} = \frac{299792458m/s}{2 * 51.2ms * 24.000GHz} = \mathbf{0.122ms}$$

$$\mathbf{V_{max}} = V_{min} * \left(\frac{N}{2} - 1\right) = 0.122ms * \left(\frac{128}{2} - 1\right) = \mathbf{7.68ms}$$

$$\mathbf{LP} = \frac{1}{2 * T_a} = \frac{1}{2 * 400\mu s} = \mathbf{1250Hz}$$

$$\mathbf{HP} = \frac{1}{T_{sample}} = \frac{1}{51.2} = \mathbf{19.53Hz}$$

## 4. FMCW Principle

### Basis elements

The FMCW-(Frequency-Modulated-Continuous-Wave) radar is a common approach to detect stationary objects.

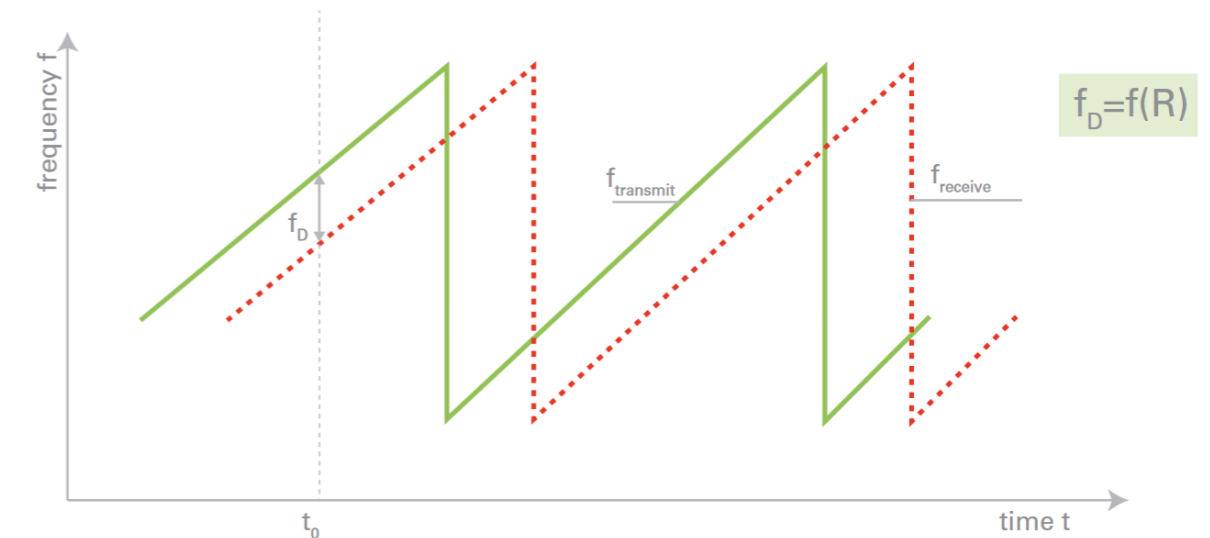

Time-dependent shape of transmit and receive signal of a FMCW radar with sawtooth modulation scheme

Unlike a Pulse Radar the FMCW sensor emits a continuous wave changing the frequency linearly over time. Due to the propagation delay the received signal shows a slightly different frequency compared to the presently generated signal leading to a beat frequency in the receiver, which is proportional to the travelling time.

The following equation describes the relation in case of a sawtooth-modulation:

$$R = \frac{C_0}{2} * T * \frac{f_D}{\Delta f}$$

$f_D$	differential frequency
$\Delta f$	frequency deviation (bandwidth)
$T$	sawtooth repetition time period
$R$	distance of a reflecting object
$C_0$	speed of light

For the 24GHz-ISM-Band the modulation bandwidth is limited by regulation to 250MHz at maximum. In consequence the range resolution is limited to 60cm as a theoretical value. In practice ranging for distances greater than 2m is possible with simple data processing. Closer ranges are possible using more complex algorithms.

For more detailed information on the radar basics, see Application\_Note I-IV on the InnoSenT homepage.

### Crosstalk

A typical problem of FMCW radar is the crosstalk between transmitter and receiver due to non-ideal isolation between them. The crosstalk effect causes blind zone approximately 3m from sensor at 24GHz. This blind zone can be reduced by applying Highpass filtering, but it cannot be eliminated entirely.

### Example

The calculation of the parameters of the implemented FMCW-modulation example is shown below:

speed of light	C0	299792458	m/s
bandwidth	B	depending on FREQ_START and FREQ_STOP	Hz
		Example: 250	MHz
sampling period	Ta	0.0004	s
		400	µs
puffer length (number of samples)	N	128	
sampling time (modulation time)	Tsample	0.0512	s
		51.2	ms
range resolution	Rmin	0.60	m
maximum range (theoretical)	Rmax	37.8	m
low pass filter (theoretical)	LP	1250	Hz
low pass filter (current hardware)		915	Hz
high pass filter (theoretical)	HP	19.53	Hz
high pass filter (current hardware)		20	Hz

FREQ\_START = 24.000GHz

FREQ\_STOP = 24.250GHz

$$B = \text{FREQ}_{\text{STOP}} - \text{FREQ}_{\text{START}} = 24.000\text{GHz} - 24.250\text{GHz} = \mathbf{250\text{MHz}}$$

$$T_{\text{sample}} = T_a * N = 400\mu\text{s} * 128 = \mathbf{51.2\text{ms}}$$

$$R_{\text{min}} = \frac{C_0}{2 * B} = \frac{299792458\text{m/s}}{2 * 250\text{MHz}} = \mathbf{0.60\text{m}}$$

$$R_{\text{max}} = R_{\text{min}} * \left(\frac{N}{2} - 1\right) = 0.60\text{m} * \left(\frac{128}{2} - 1\right) = \mathbf{37.8\text{m}}$$

$$LP = \frac{1}{2 * t_a} = \frac{1}{2 * 400\mu\text{s}} = \mathbf{1250\text{Hz}}$$

$$HP = \frac{1}{T_{\text{sample}}} = \frac{1}{51.2} = \mathbf{19.53\text{Hz}}$$

## 5. Getting Started

### Receive Signals Visualization

The SMR-EvalKit is a plug-and-play device. The system will boot the previously uploaded firmware as soon as it receives power via its USB port and the IF signals can be visualized using the SMR EvalKit GUI.

To visualize receive signals:

- open the SMR EvalKit GUI
- select corresponding **Comport** of SMR EvalKit
- Click Connect/Disconnect button to **connect** or **disconnect** to SMR EvalKit Comport

In the GUI, the upper graph shows the raw receive signals on I- and Q-channel. The magnitudes are scaled in digit values. The bottom graph shows the corresponding FFT of raw receive signals and is displayed logarithmic (dB).

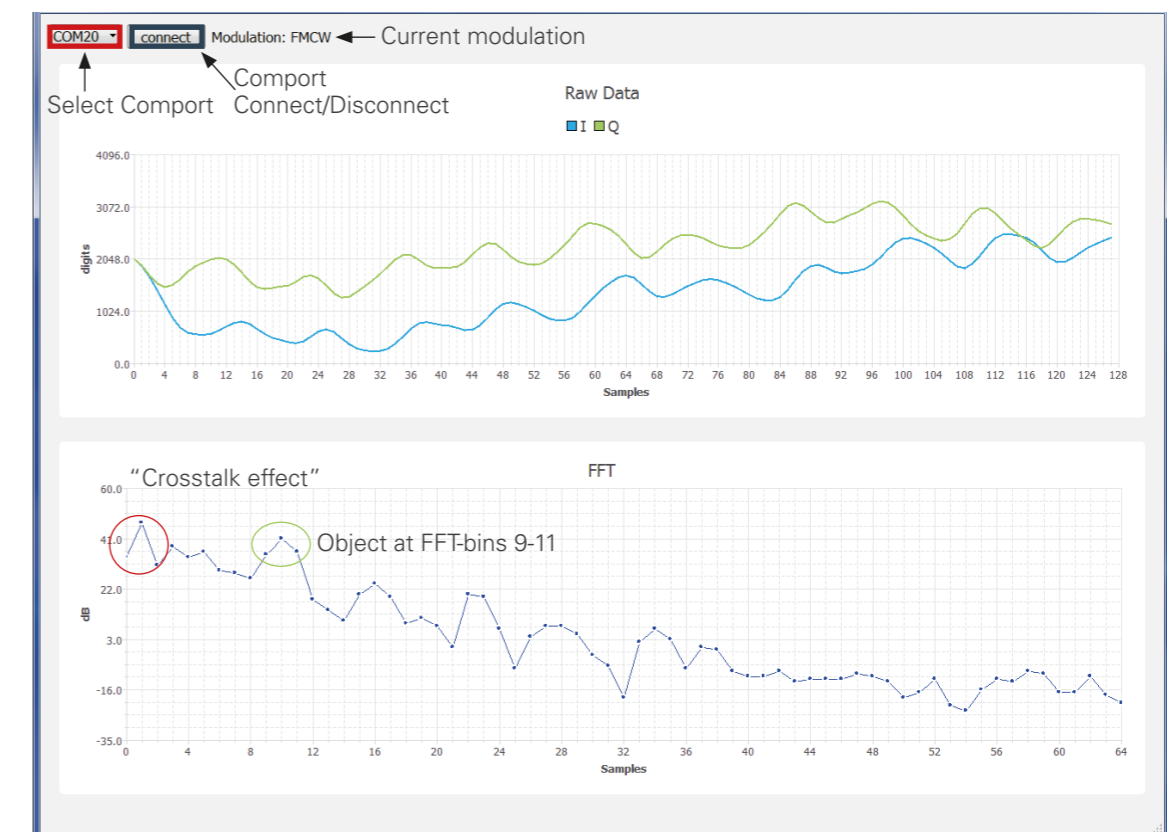

Note: When starting SMR-Evalkit, it may take a few seconds to perform initial frequency calibration and there is no data being transmitted to the PC during this time. It might take a few moments until a signal is displayed in the GUI.

### Radar Setting Modification

By modifying and uploading the source code onto the microcontroller board, the radar settings can be changed to different configurations. The following instructions show the procedure for doing this:

- a) Create a workspace folder for the project e.g: "C:\SMR\_EvaluationKit\_WS"
- b) Copy the SMR EvalKit firmware project folder into the workspace
- c) Run SW4STM32 software and select the created workspace folder

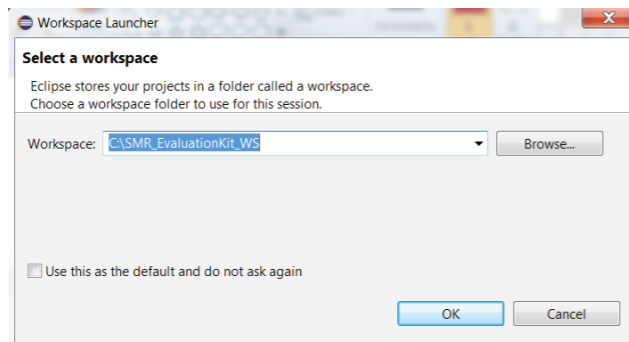

- d) Go to workbench

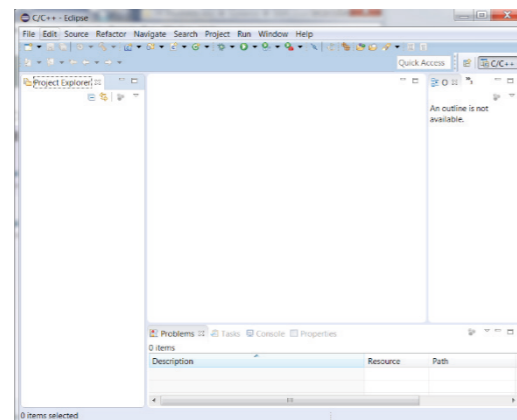
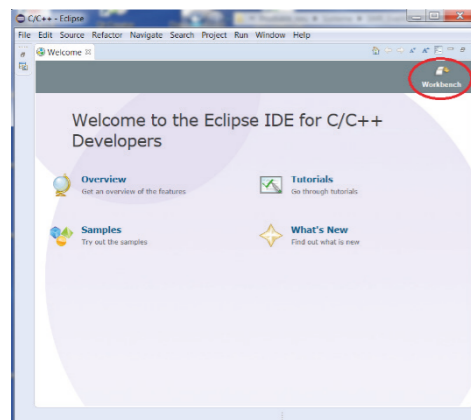

- a) Import the project containing the source code into the workspace. In the Project Explorer tab -> Right Click -> Import -> General -> Existing Projects into Workspace -> Select root directory -> Brower -> "select directory where the source code project located" -> OK -> Finish

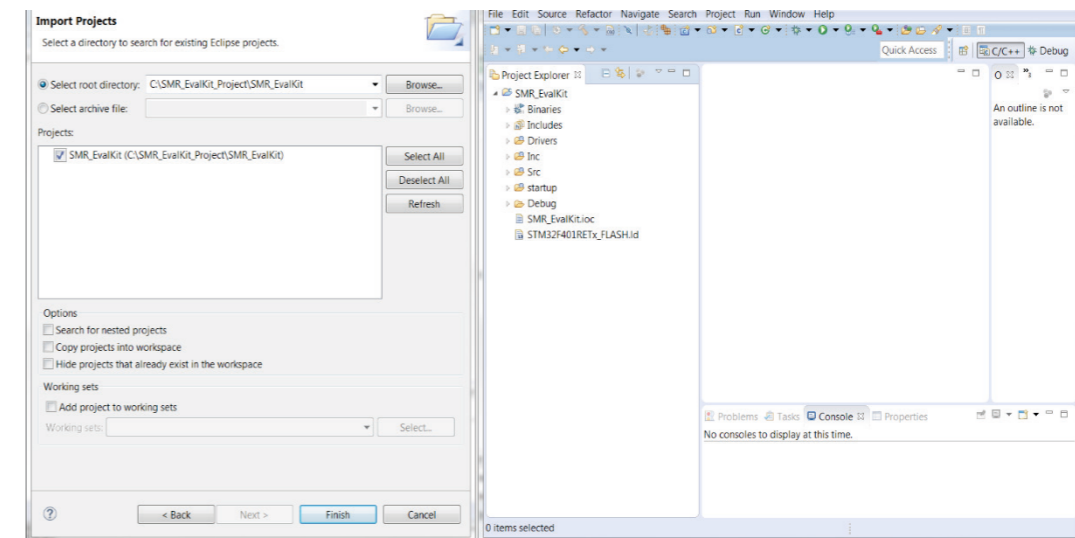
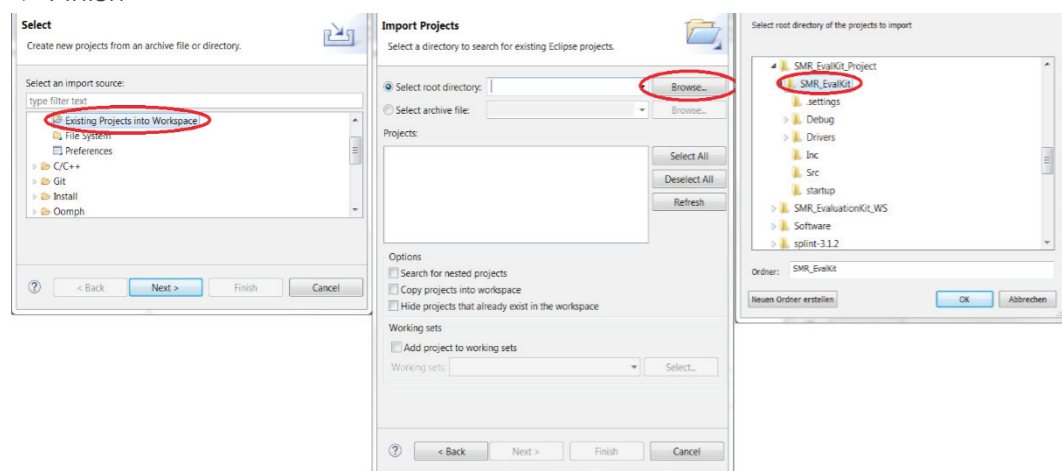

- b) Expand the project and open the file "CONFIG.h" in "Inc" folder

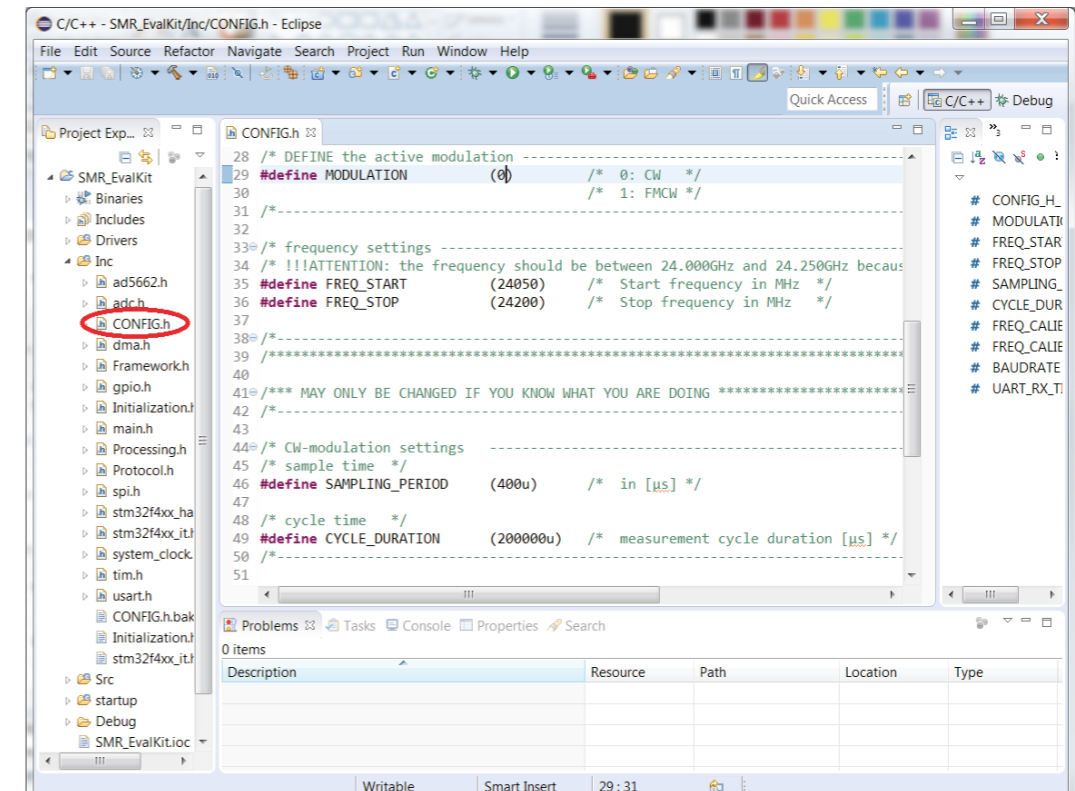

c) The radar setting can be changed by modifying the parameters in this "CONFIG.h" file. For example changing radar configuration to FMCW mode by setting "#define MODULATION (1) "

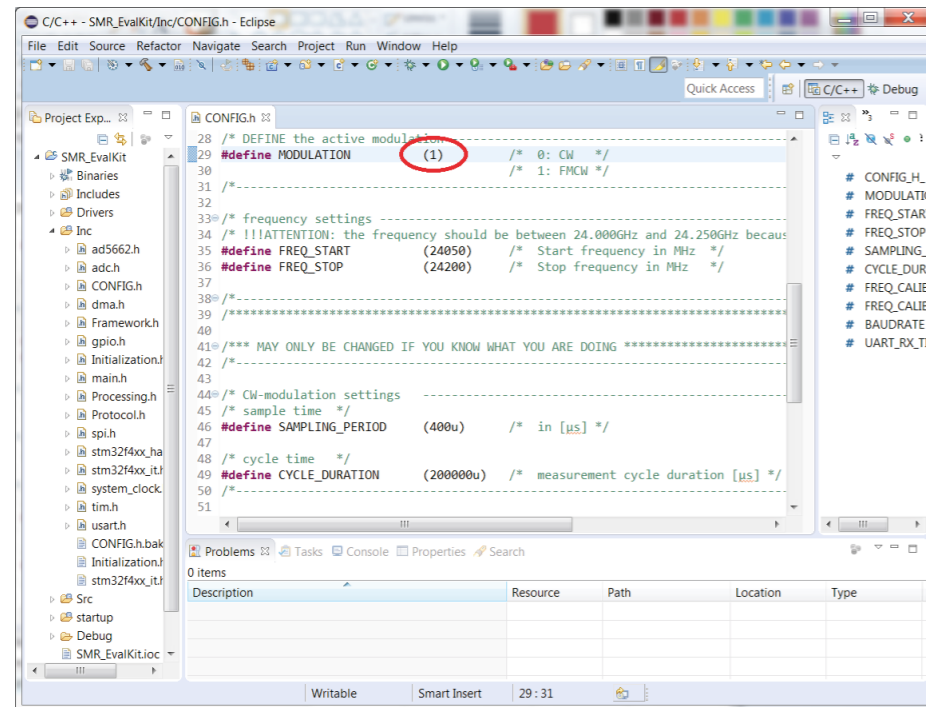

d) Build the project after changing radar setting in "CONFIG.h" file. Note: It may be necessary to clean and refresh the project folder before building. Right click on project folder -> Clean Project. Right click on project folder -> Refresh. Right click on project folder -> Build Project.

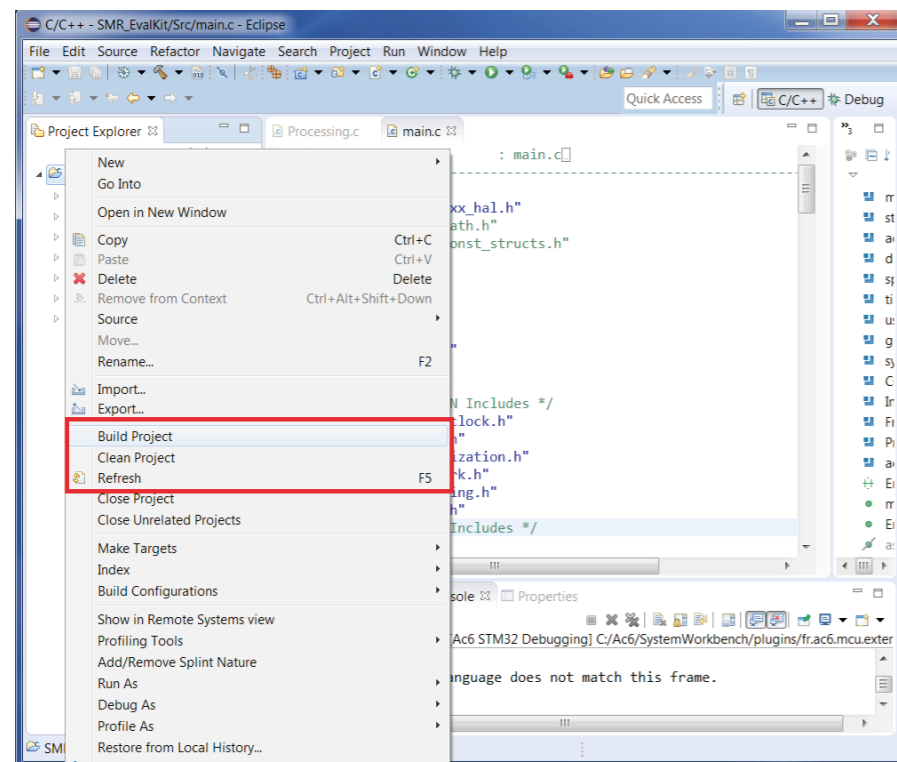

e) Upload the modified source code onto microcontroller board. Right click on project folder (or left click on debug arrow button) -> Debug As -> Ac6 STM32 C/C++ Application

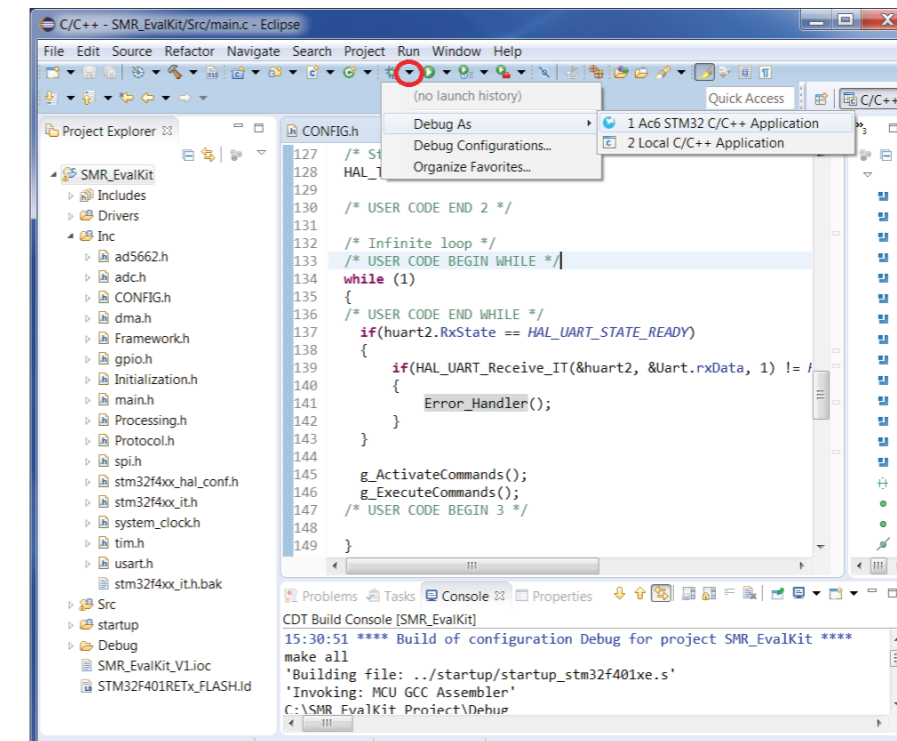

f) To run the application. Click on "Run" button.

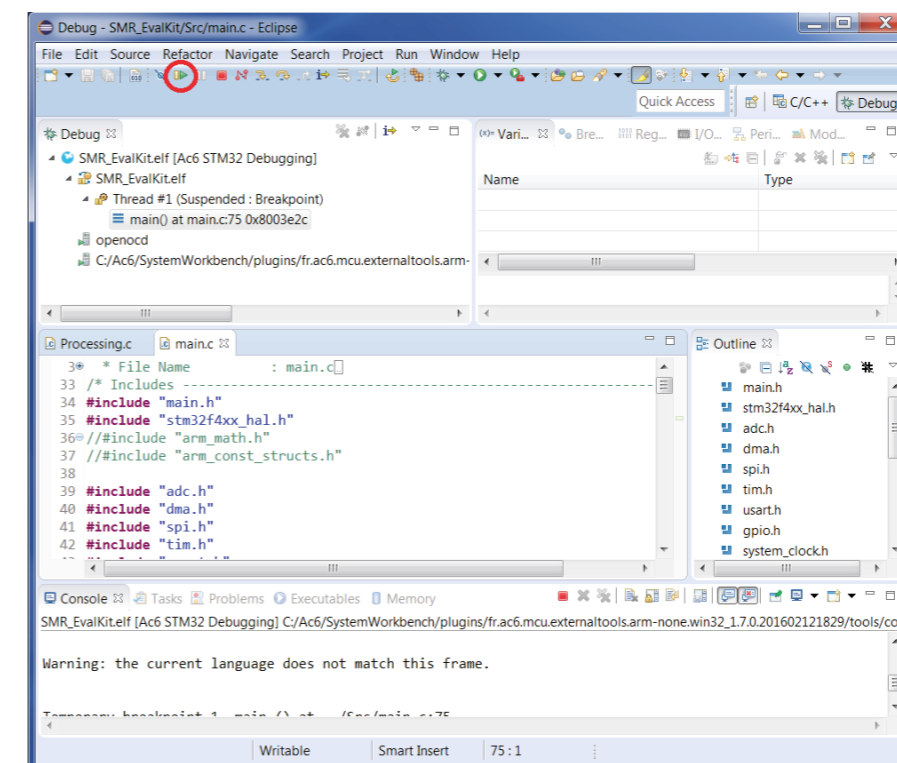

g) Once the firmware has even uploaded to the target and has been run it will be stored in the controllers flash memory and run even without connecting to the system workbench on power up.



SMR-EvalKit Pin layout and software components

a) STM32Cubemx

The SMR-EvalKit pin layout as well as software components configurations can be viewed using STM32Cubemx. To do this, open STM32Cubemx software and load the file "SMR\_EvalKit.ioc" in the SMR\_EvalKit\_Project folder.

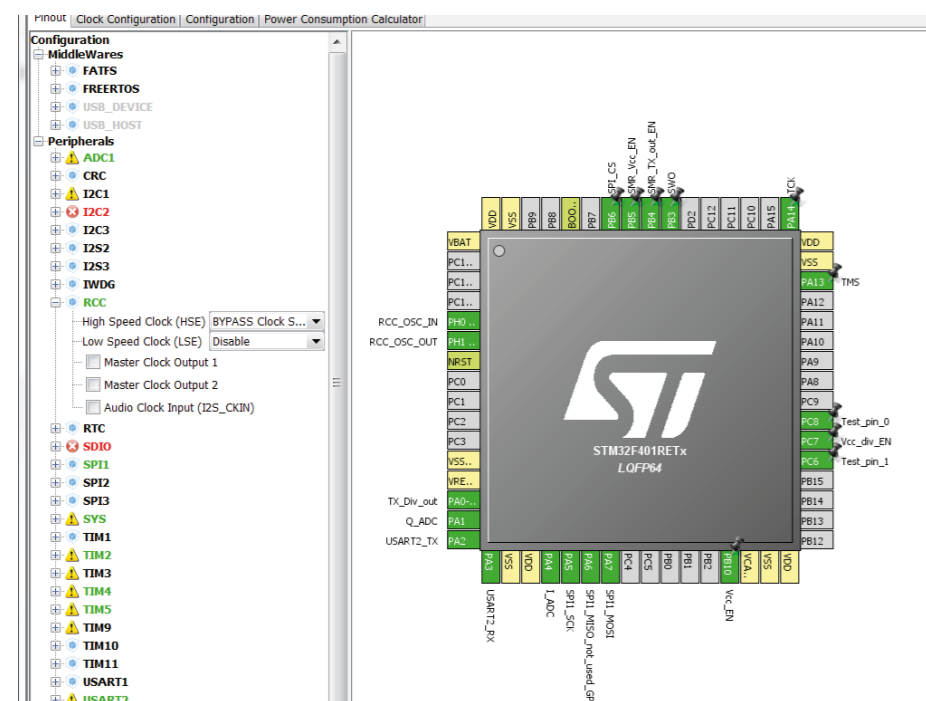
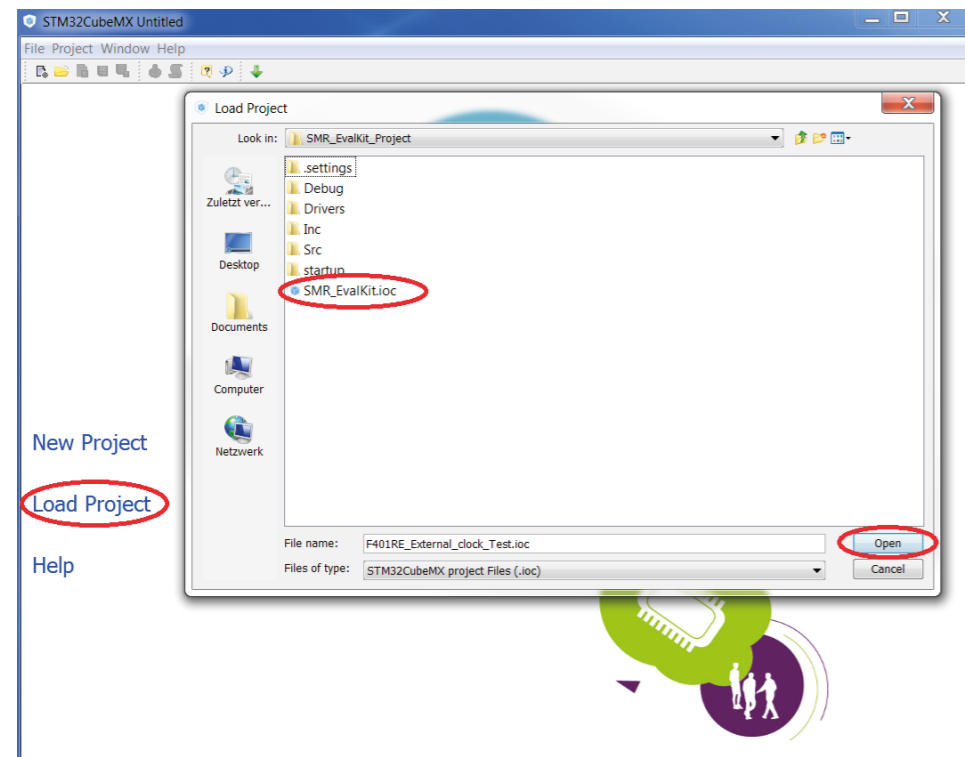

Morpho headers

These headers give access to all STM32 pins.

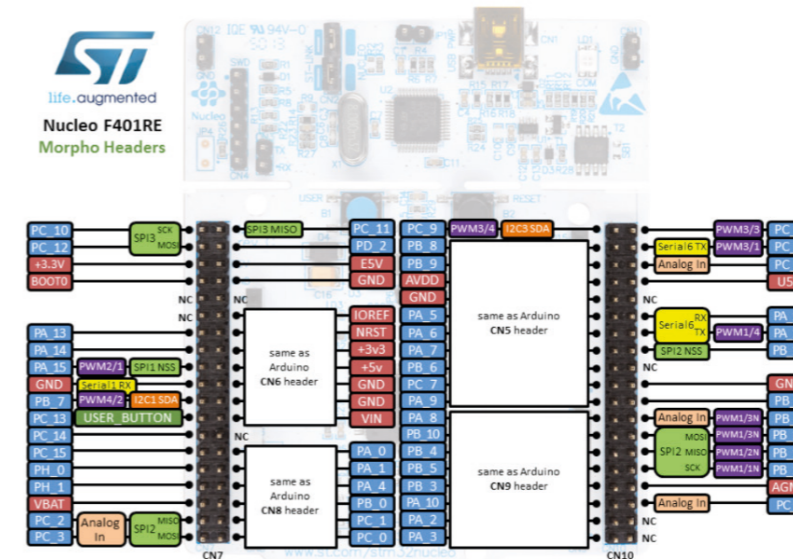

STM32F401RE Pin map (<https://developer.mbed.org/platforms/ST-Nucleo-F401RE/>)

b) SMR-EvalKit Pin Configuration

Name	Pin map	GPIO	Description	Note
Vcc_EN	PB10	Output	Power supply of SMR board	High-active
SMR_Vcc_EN	PB5	Output	Power supply SMR radar module	High-active
SMR_Tx_out_EN	PB4	Output	Transmit signal amplifier	High-active
Vcc_div_EN	PC7	Output	Transmit signal down-conversion	High-active
Tx_Div_out	PA0	Input	Down-converted transmit signal	Square wave signal
Test_pin_0	PC8	Output	For testing purpose	high-active
Test_pin_1	PC6	Output	For testing purpose	high-active
RCC_OSC_IN	PH0	n/a	External clock input	n/a
RCC_OSC_OUT	PH1	n/a	External clock output	n/a
I_ADC	PA4	Input	Receive I-Channel signal	Analog
Q_ADC	PA1	Input	Receive Q-Channel signal	Analog
SPI1_CS	PB6	Output	SPI Chip select	Low-active
SPI1_CLK	PA5	Output	SPI Communication clock	high-active
SPI1_MOSI	PA7	Output	SPI Transmission of data to SMR board	high-active
SPI1_MISO	PA6	Input	SPI Reception of data from SMR board	Unused
USART2_TX	PA2	Output	Transmission of receive signal to PC	High-active
USART2_RX	PA3	Input	Reception commands from PC	Unused
TCK	PA13	n/a	Debug serial wire clock	n/a
TMS	PA14	n/a	Debug serial wire I/O	n/a
SWO	PB3	n/a	Debug serial wire output trace port	n/a

SMR-EvalKit pin configuration with respect to STM32F401RE microcontroller board

Note: when toggling the following SMR I/O-pins: Vcc\_EN, SMR\_Vcc\_EN, SMR\_Tx\_EN, Vcc\_Div\_EN, it is absolutely important to follow the scheme below with a 1ms delay between each pin.

Switching on: Vcc\_EN -> SMR\_Vcc\_EN -> SMR\_Tx\_EN and Vcc\_div\_EN  
 Switching off: SMR\_Tx\_EN and Vcc\_Div\_EN -> SMR\_Vcc\_EN -> Vcc\_EN

c) Software components brief description

Component	Usage
HSE	<ul style="list-style-type: none"> <li>High speed external clock for clocking MCU system</li> </ul>
Timer_2	<ul style="list-style-type: none"> <li>Measure SMR down-converted transmit signal frequency</li> </ul>
Timer_4	<ul style="list-style-type: none"> <li>Control ADC sampling period</li> <li>Generate FMCW ramp</li> <li>Monitor measurement cycle duration</li> </ul>
Timer_5	<ul style="list-style-type: none"> <li>Monitor communication message timeout via USART</li> </ul>
SPI	<ul style="list-style-type: none"> <li>Set SMR transmit frequency</li> </ul>
ADC	<ul style="list-style-type: none"> <li>Sample analog receive signals of SMR module</li> </ul>
DMA	<ul style="list-style-type: none"> <li>Read sampled signals from ADC registers</li> <li>Write data to SPI registers</li> </ul>
USART	<ul style="list-style-type: none"> <li>Communicate to PC</li> </ul>
GPIO	<ul style="list-style-type: none"> <li>Interface between SMR board and MCU board</li> </ul>

## 6. Radar configurable parameters

The "CONFIG.h" file in the source code provides a list of configurable parameters.

Parameter	Description	Note	Unit
MODULATION	selecting of radar principle	0: Doppler principle 1: FMCW principle	-
FREQ_START <sup>*)</sup>	Start frequency in FMCW mode	Min: 24000 Max: 24250	MHz
FREQ_STOP	Stop frequency in FMCW mode	Min: 24000 Max: 24250	MHz
FREQ_CALIB_EN	Frequency calibration enable	0: Off 1: On	
SAMPLE_PERIOD	ADC sampling interval	1*)	µs
CYCLE_DURATION	Measurement cycle duration	2*)	µs
FREQ_CALIB_INTVL	Frequency auto-calibration interval		Number of cycles
BAUDRATE	Data transmission rate	Default: 115000	Bits/s

\*) : FREQ\_START must always be smaller than FREQ\_STOP:  $FREQ\_START < FREQ\_STOP$

1\*): A careful consideration should be taken when changing the parameter "SAMPLE\_PERIOD" since an improper value of this parameter may cause application software not functioning correctly.

2\*):  $Min. \text{ CYCLE\_DURATION} = \text{SAMPLE\_PERIOD} * \text{FFT\_SIZE} + \text{FRAME\_LENGTH} * 10 / \text{BAUDRATE}$   
 E.g.:  $\text{SAMPLE\_PERIOD} = 400\mu\text{s}$ ,  $\text{FFT\_SIZE} = 128$ ,  $\text{FRAME\_LENGTH} = 1031 \text{ bytes}$ ,  $\text{BAUDRATE} = 115000\text{bits/s}$

->  $Min. \text{ CYCLE\_DURATION} = 400\mu\text{s} * 128 + 1031 * 10 / 115200 \approx 141\text{ms}$

## 7. Data Transmission

At the end of each measurement, the raw data as well as its FFT magnitudes in logarithmic scale will be transmitted to the GUI. The data is transmitted in a frame with the following structure:

**Example:** FFT\_SIZE = 128 (i.e. 128 samples)

Byte No.	Byte 1	Byte 2	Byte 3	Byte 4,5	Byte 6,7	Byte 260,261 260,261	Byte 262,263	Byte 516,517	Byte 518,519 520,521	Byte 1026,1027 1028,1029	Byte 1030	Byte 1031
Data type	uint8	uint8	uint8	uint16	int16	int16	int16	int16	int32	int32	1 byte	1 byte
Content	SD	FC	Modulation	Number sample	Raw I1	Raw I128	Raw Q1	Raw Q128	FFT-mag 1	FFT-mag 128	CS	ED

<b>SD:</b> start delimiter = 162 (0xA1)	uint8
<b>FC:</b> function code = 224 (0xE0)	uint8
<b>Modulation:</b> 0-Doppler, 1-FMCW	uint8
<b>Number sample:</b> number of captured samples for single measurement	uint16
<b>Raw I1:</b> sample 1st of raw I signal	int16
<b>Raw I128:</b> sample 128th of raw I signal	int16
<b>Raw Q1:</b> sample 1st of raw Q signal	int16
<b>Raw Q128:</b> sample 128th of raw Q signal	int16
<b>FFT-mag 1:</b> magnitude of FFT sample 1st in logarithmic scale	int32
<b>FFT-mag 128:</b> magnitude of FFT sample 128th in logarithmic scale	int32
<b>CS:</b> checksum = (sum of Byte2 to Byte1029) & 0x000000FF	uint8
<b>ED:</b> end delimiter = 22 (0x16)	uint8

Note: Depending on FFT\_SIZE the frame length will change and byte numbers may need to be adjusted, however the frame's structure remains.

### Transmission State

During the time when data is being transmitted to the PC, "LED2" on the microcontroller board will turn on and it will turn off again when the transmission is completed. During normal operation the LED will flash due to the continuous data transmission.

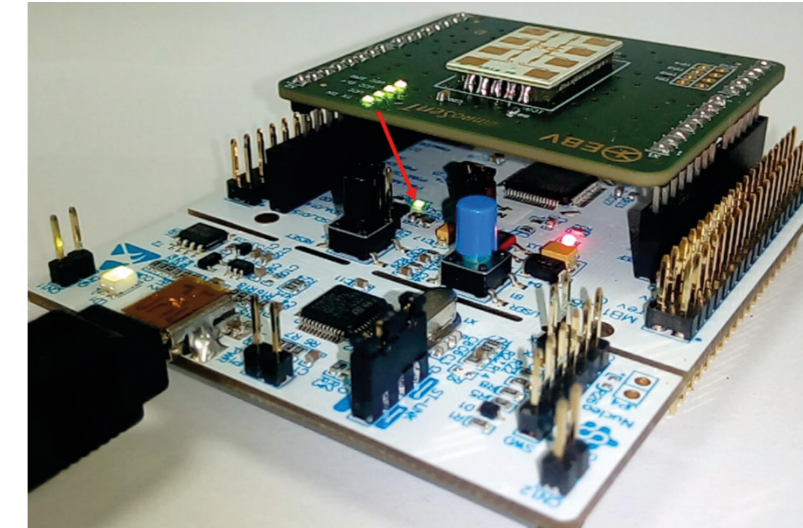

## Signal Processing

This is an illustration of the signal processing for both Doppler and FMCW mode.

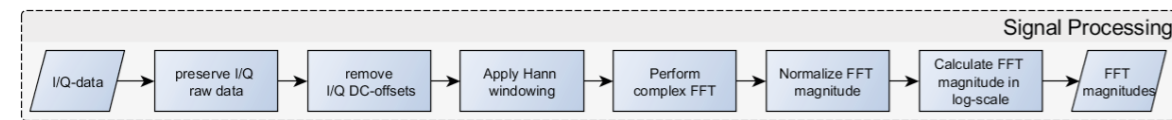

## 8. Frequency Auto-Calibration

One highlighted feature of the SMR-Evalkit is the ability to minimize transmit frequency drift over temperature. The following diagram describes the principle behind the frequency calibration.

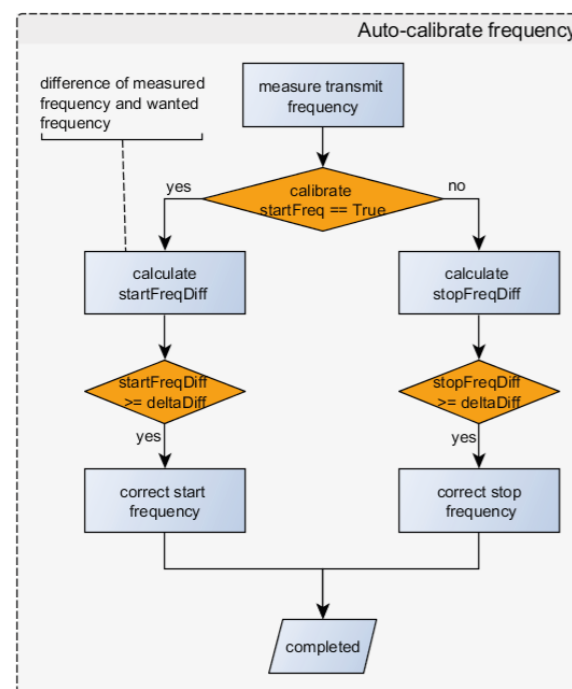

a) In the first step the transmit frequency of SMR module is measured. Afterwards the difference between the target transmit frequency and the measured transmit frequency is calculated. Based on this difference the transmit frequency is changed accordingly and tested again.

### Transmit frequency measurement

The SMR-module outputs a square wave prescaler signal with a frequency corresponding to 1:8192 of its current transmit frequency. The prescaler is enabled by connecting "Vcc\_div\_EN" to 3.3V.

Example: A transmit frequency of 24.125GHz will result in a square wave signal with a frequency of approx. 2.944946MHz.

This square wave signal is routed into the microcontroller board via the "TX\_Div\_out" pin. In order to measure the frequency of the square wave signal, an input-capture channel of the microcontroller is applied on the "TX\_Div\_out" pin to detect and count the number of rising edges of the square wave signal in a duration of 100ms. After the sampling process, the frequency of the square wave signal is calculated by dividing the number of detected rising edges by 100ms.

Example: 293584 rising edges detected -> 2.93584MHz square wave signal

### b) Frequency shift calculation

After measuring the frequency of the square wave signal, the difference between the target frequency and the measured frequency is calculated and used for correcting the transmit frequency.

### c) Transmit frequency correction

The calculated frequency difference is compared with a frequency tolerance. When the difference exceeds the tolerance, an adjustment for transmit frequency with a pre-defined value is performed to move the transmit frequency closer to desired frequency.

This frequency auto-calibration routine is repeated after a defined duration and this defined duration can be configured by the users. After calibration process, the application will wait for one measurement cycle before continuing with measurements.

Note: In Doppler mode only start frequency is calibrated. In FMCW mode, start- and stop-frequency are calibrated alternately.

## 9. Complete Application Diagram

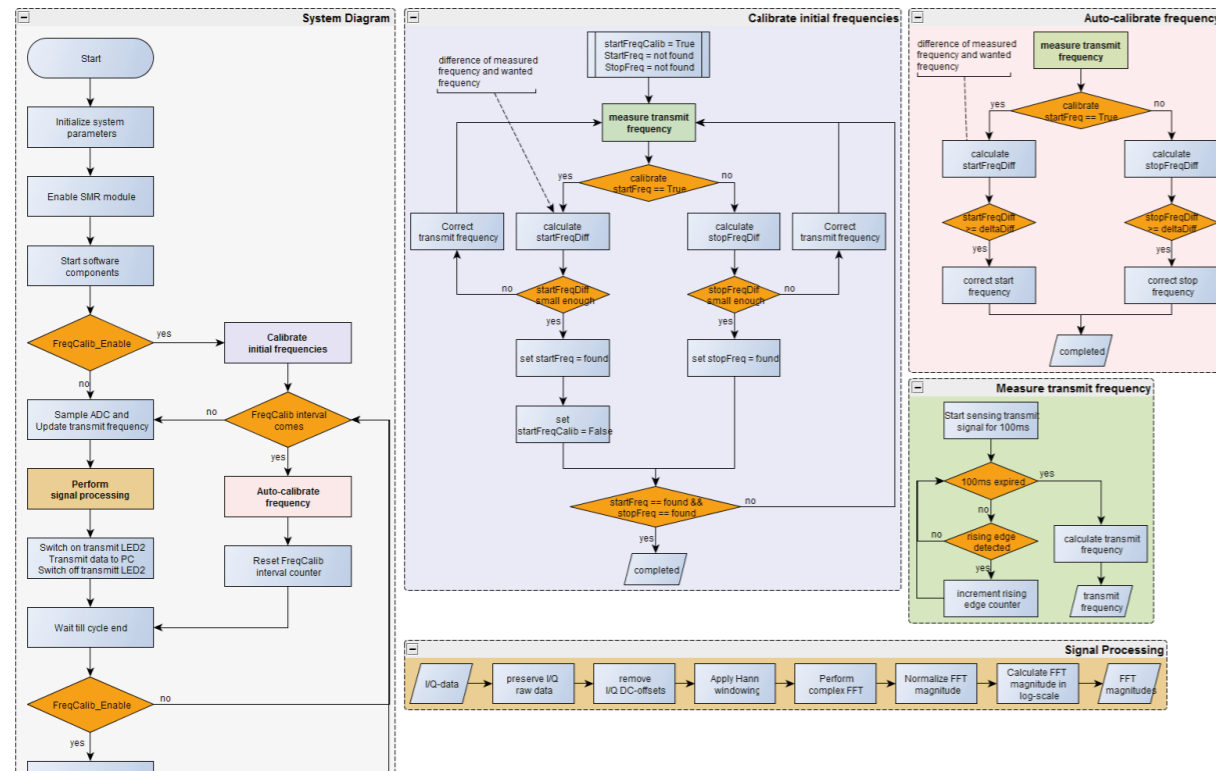

## 10. Hardware

Schematic circuit

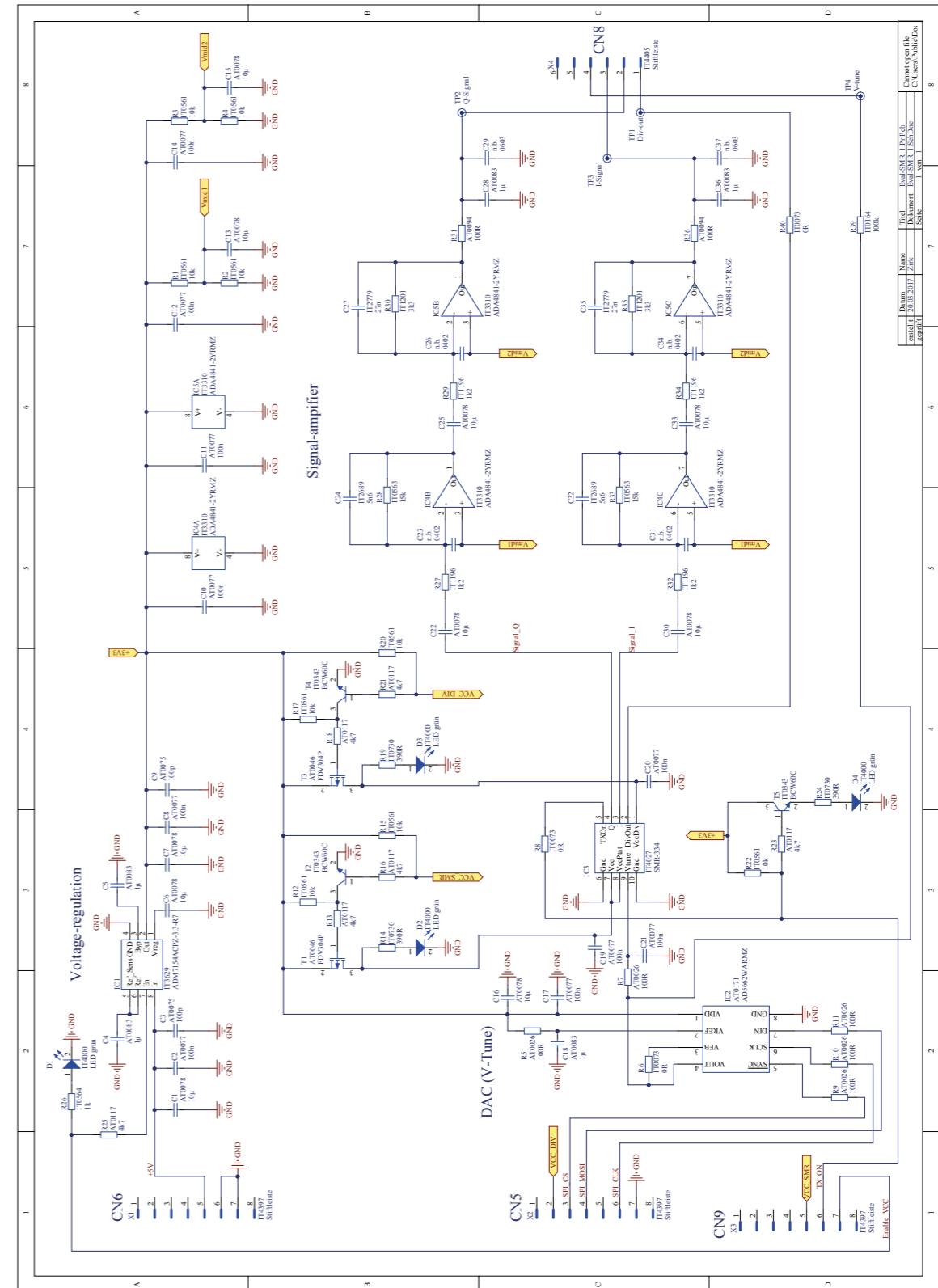

Layout

TOP

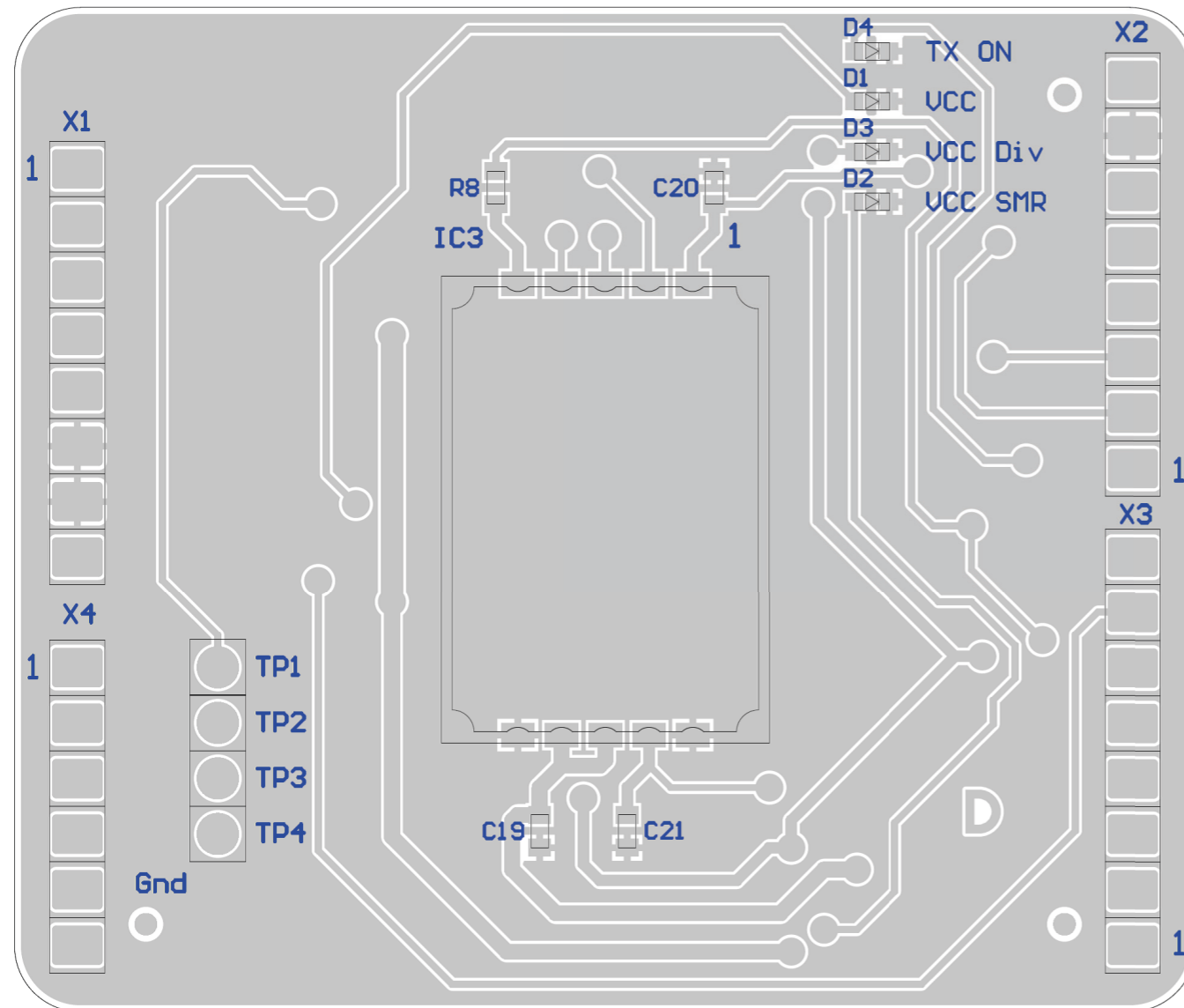

BOTTOM

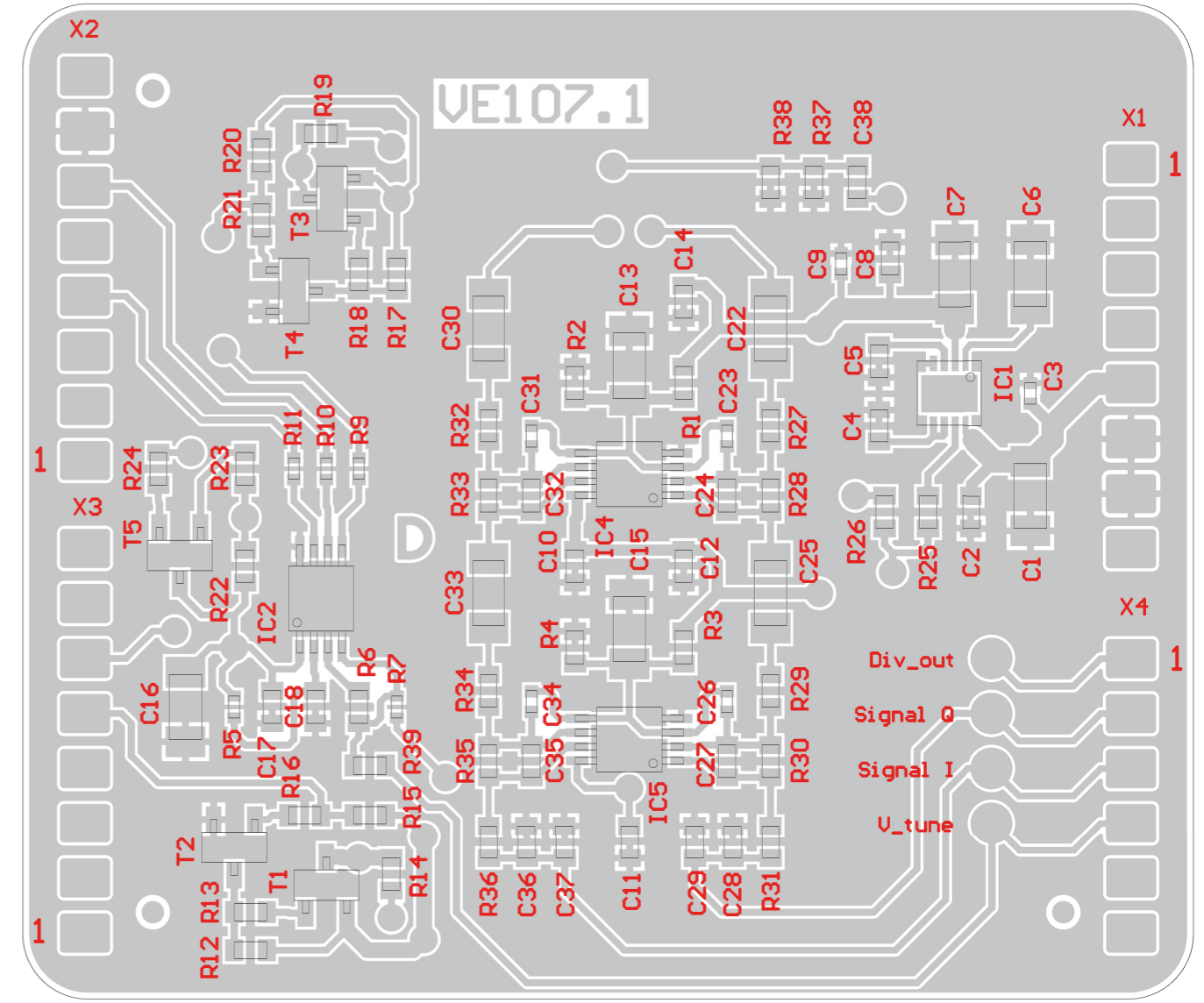

## SMR Technical characteristics

See Data Sheet SMR-334

# 11. References

STM32F401RE Nucleo reference manual:

[http://www.st.com/content/ccc/resource/technical/document/reference\\_manual/5d/b1/ef/b2/a1/66/40/80/DM00096844.pdf/files/DM00096844.pdf/jcr:content/translations/en.DM00096844.pdf](http://www.st.com/content/ccc/resource/technical/document/reference_manual/5d/b1/ef/b2/a1/66/40/80/DM00096844.pdf/files/DM00096844.pdf/jcr:content/translations/en.DM00096844.pdf)

STM32F401xE datasheet: <http://www.st.com/content/ccc/resource/technical/document/datasheet/30/91/86/2d/db/94/4a/d6/DM00102166.pdf/files/DM00102166.pdf/jcr:content/translations/en.DM00102166.pdf>

STM32 Nucleo-64 board user manual:

[http://www.st.com/content/ccc/resource/technical/document/user\\_manual/98/2e/fa/4b/e0/82/43/b7/DM00105823.pdf/files/DM00105823.pdf/jcr:content/translations/en.DM00105823.pdf](http://www.st.com/content/ccc/resource/technical/document/user_manual/98/2e/fa/4b/e0/82/43/b7/DM00105823.pdf/files/DM00105823.pdf/jcr:content/translations/en.DM00105823.pdf)

# 12. History

Document revision	Date	Change log	Author
1	01.03.2017	first release	BL
1.1	20.03.2017	Added description "Transmission State"	SG
1.2	26.07.2017	Release	CD
1.3	22.05.2018	Corrected USART2_TX/RX pins	BL



InnoSenT GmbH  
Am Roedertor 30  
97499 Donnersdorf  
Germany

Tel.: +49-9528-9518-0  
Fax.: +49-9528-9518-99  
E-mail: [info@innosent.de](mailto:info@innosent.de)  
[www.innosent.de](http://www.innosent.de)