



FXOS8700CQ

6-axis sensor with integrated linear accelerometer and magnetometer

Rev. 7.0 - 22 March 2016

Data sheet: Technical data

1. General description

FXOS8700CQ is a small, low-power, 3-axis, linear accelerometer and 3-axis, magnetometer combined into a single package. The device features a selectable I²C or *point-to-point* SPI serial interface with 14-bit accelerometer and 16-bit magnetometer ADC resolution along with smart-embedded functions. FXOS8700CQ has dynamically selectable acceleration full-scale ranges of $\pm 2\text{ g}/\pm 4\text{ g}/\pm 8\text{ g}$ and a fixed magnetic measurement range of $\pm 1200\ \mu\text{T}$. Output data rates (ODR) from 1.563 Hz to 800 Hz are selectable by the user for each sensor. Interleaved magnetic and acceleration data is available at ODR rates of up to 400 Hz. FXOS8700CQ is available in a plastic QFN package and it is guaranteed to operate over the extended temperature range of $-40\text{ }^{\circ}\text{C}$ to $+85\text{ }^{\circ}\text{C}$.

2. Features and benefits

- Complete 6-axis, e-compass hardware solution
- 1.95 V to 3.6 V VDD supply voltage, 1.62 V to 3.6 V VDDIO voltage
- $\pm 2\text{ g}/\pm 4\text{ g}/\pm 8\text{ g}$ dynamically selectable acceleration full-scale range
- $\pm 1200\ \mu\text{T}$ magnetic sensor full-scale range
- Output data rates (ODR) from 1.563 Hz to 800 Hz for each sensor, and up to 400 Hz when operated in hybrid mode with both sensors active
- Low noise: $< 126\ \mu\text{g}/\sqrt{\text{Hz}}$ acceleration noise density at 200-Hz bandwidth, $< 100\ \text{nT}/\sqrt{\text{Hz}}$ magnetic noise density at 100-Hz bandwidth
- 14-bit ADC resolution for acceleration measurements
- 16-bit ADC resolution for magnetic measurements
- Low power: 240 μA current consumption at 100 Hz, and 80 μA at 25 Hz with both sensors active
- Embedded programmable acceleration event functions
 - ◆ Freefall and motion detection
 - ◆ Transient detection
 - ◆ Vector-magnitude change detection
 - ◆ Pulse and tap detection (single and double)
 - ◆ Orientation detection (portrait/landscape)
- Embedded programmable magnetic event functions
 - ◆ Threshold detection
 - ◆ Vector-magnitude change detection
 - ◆ Autonomous magnetic min/max detection
 - ◆ Autonomous hard-iron calibration



- Programmable automatic ODR change using auto-wake and return-to-sleep functions to save power. This function works with both magnetic and acceleration event interrupt sources.
- 32-sample FIFO for acceleration data only
- Integrated accelerometer self-test function

3. Applications

- Security: motion detection, door opening, smart home applications, robotics, and unmanned aerial vehicles (UAVs) with electronic compass (e-compass) function.
- Medical applications: patient monitoring, fall detection, and rehabilitation
- E-compass in mobile devices, tablets, and personal navigation devices
- User interface (menu scrolling by orientation change, tap detection for button replacement)
- Orientation detection (portrait/landscape: up/down, left/right, back/front orientation identification)
- Augmented reality (AR), gaming, and real-time activity analysis (pedometry, freefall, and drop detection for hard disk drives and other devices)
- Power management for mobile devices using inertial and magnetic event detection
- Wearable devices: motion detection, activity monitoring, sports monitoring, context awareness, and shock and vibration monitoring (mechatronic compensation, shipping, and warranty usage logging)

4. Ordering information

Table 1. Ordering information

Part number	Temperature range	Package description	Shipping
FXOS8700CQR1	-40 °C to +85 °C	QFN	Tape and reel

5. Block diagram

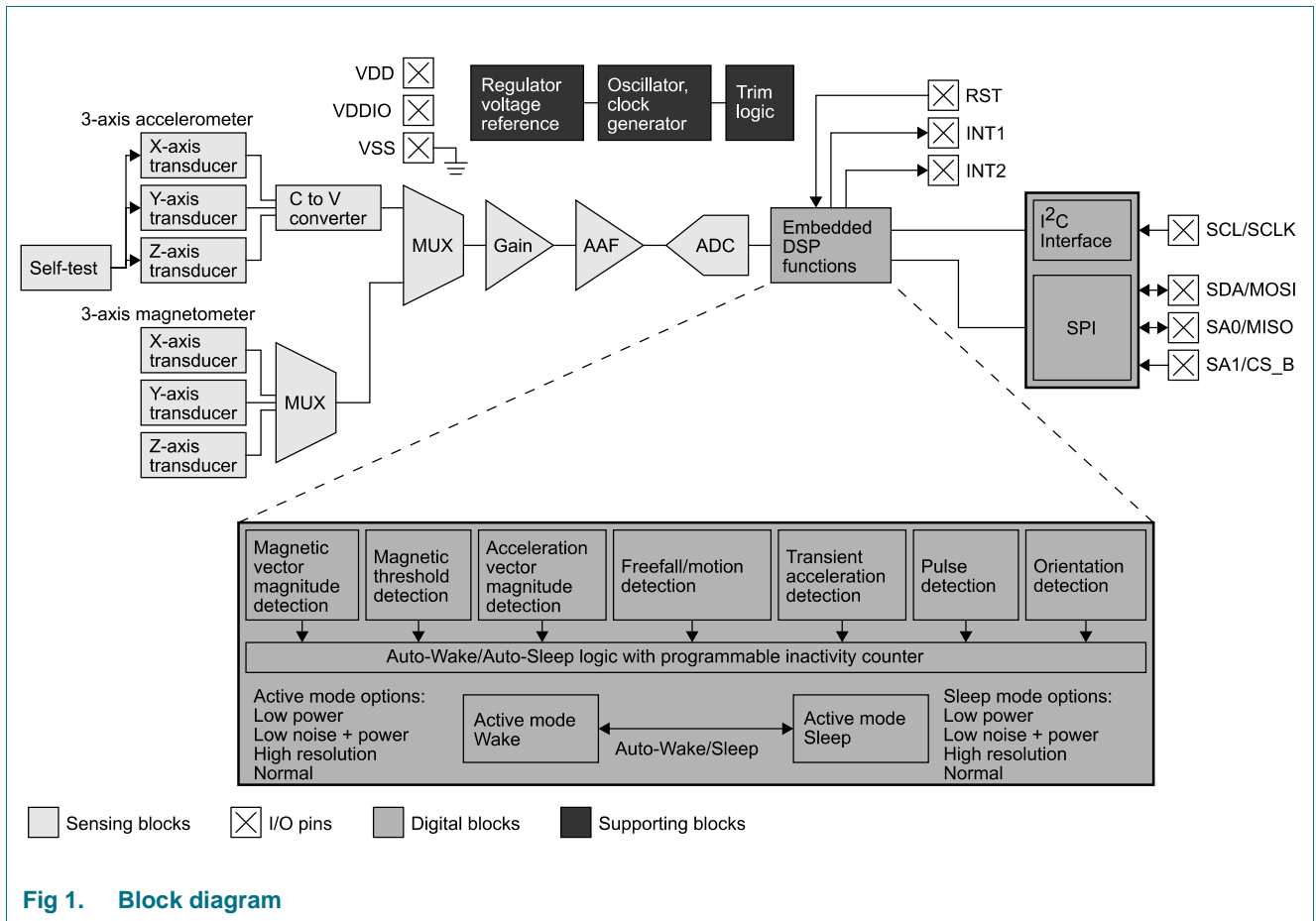
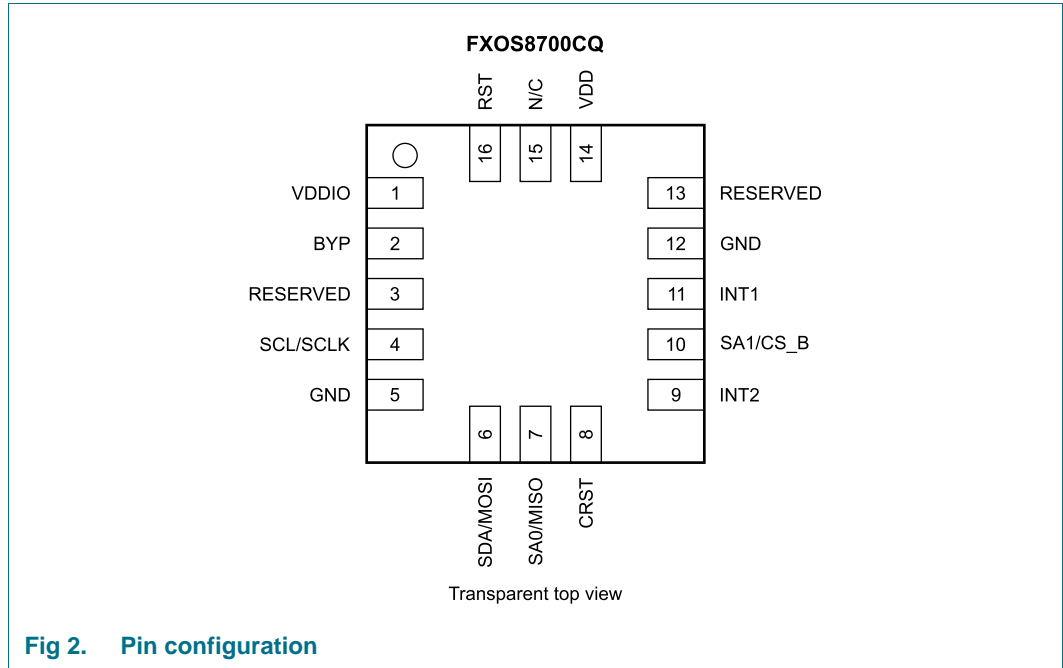

Fig 1. Block diagram

6. Pinning information

6.1 Pinning



6.2 Pin description

Table 2. Pin description

Symbol	Pin	Description
VDDIO	1	Interface supply voltage
BYP	2	Internal regulator output bypass capacitor connection
Reserved	3	Test reserved, connect to GND
SCL/SCLK	4	I ² C serial clock/SPI clock ^[1]
GND	5	Ground
SDA/MOSI	6	I ² C serial data/SPI master out, slave in ^{[1][2]}
SA0/MISO	7	I ² C address selection bit 0/SPI master in, slave out ^{[1][2][3]}
Crst	8	Magnetic reset capacitor
INT2	9	Interrupt 2
SA1/CS_B	10	I ² C address selection bit 1/SPI chip select (active low) ^{[2][3]}
INT1	11	Interrupt 1
GND	12	Ground
Reserved	13	Test reserved, connect to GND
VDD	14	Sensor supply voltage
N/C	15	Not connected internally
RST ^[2]	16	Reset input, active high. Connect to GND if unused

[1] Refer to [Section 10.2.1](#) regarding point-to-point SPI operation.

[2] Refer to [Section 10.2.3](#) regarding SPI bus requirements during 1 ms period following a reset

[3] Refer to [Table 11](#) for I²C address options selectable using the SA0 and SA1 pins.

7. Electrical connections

Device power is supplied through the VDD pin. Power supply decoupling capacitors (100 nF ceramic plus 4.7 μ F bulk) should be placed as close as possible to pin 14 of the device. The digital interface supply voltage (VDDIO) should be decoupled with a 100 nF ceramic capacitor placed as close as possible to pin 1 of the device.

The digital control signals SCL, SDA, SA0, SA1, and RST are not tolerant of voltages exceeding VDDIO + 0.3 V. If VDDIO is removed, these pins will clamp any logic signals through their internal ESD protection diodes. The function and timing of the two interrupt pins (INT1 and INT2) are user programmable through the I²C/SPI interface. The SDA and SCL I²C connections are open drain and therefore require a pullup resistor as shown in the application diagram in [Figure 3](#). The INT1 and INT2 pins may also be configured for open-drain operation. If they are configured for open drain, external pullup resistors are required.

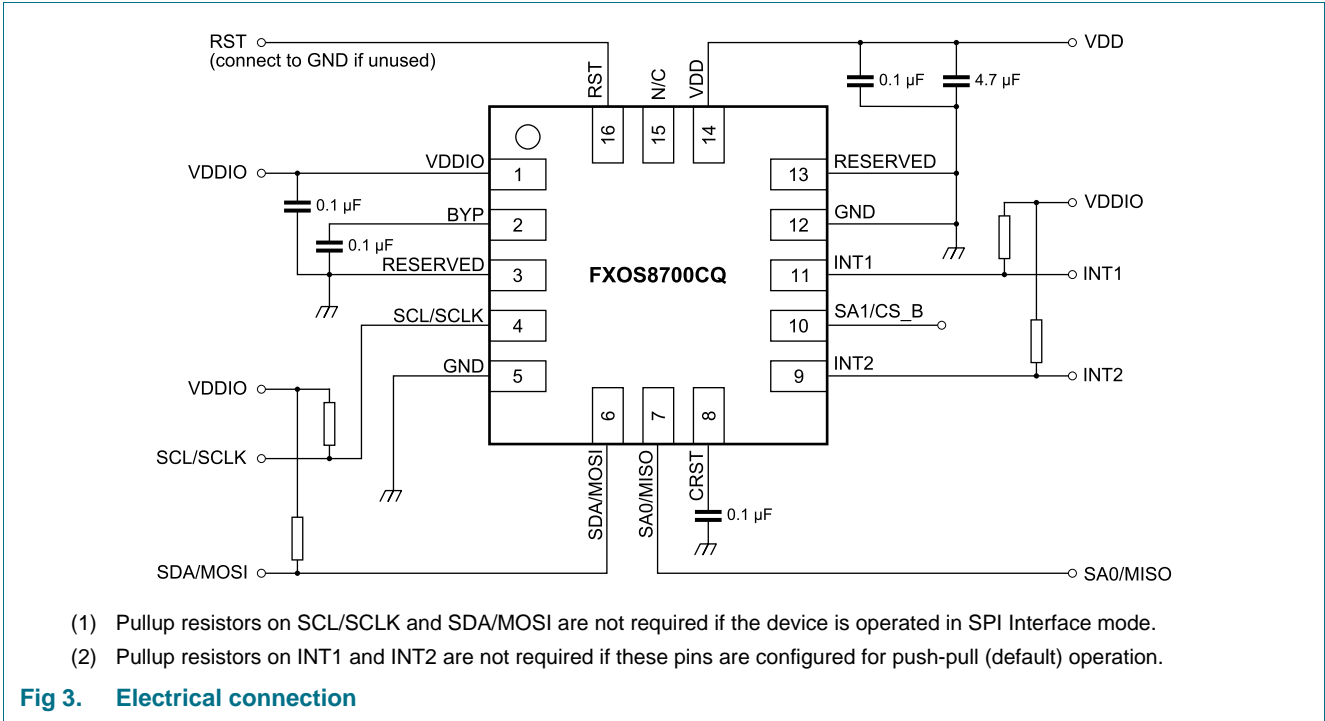

7.1 Orientation

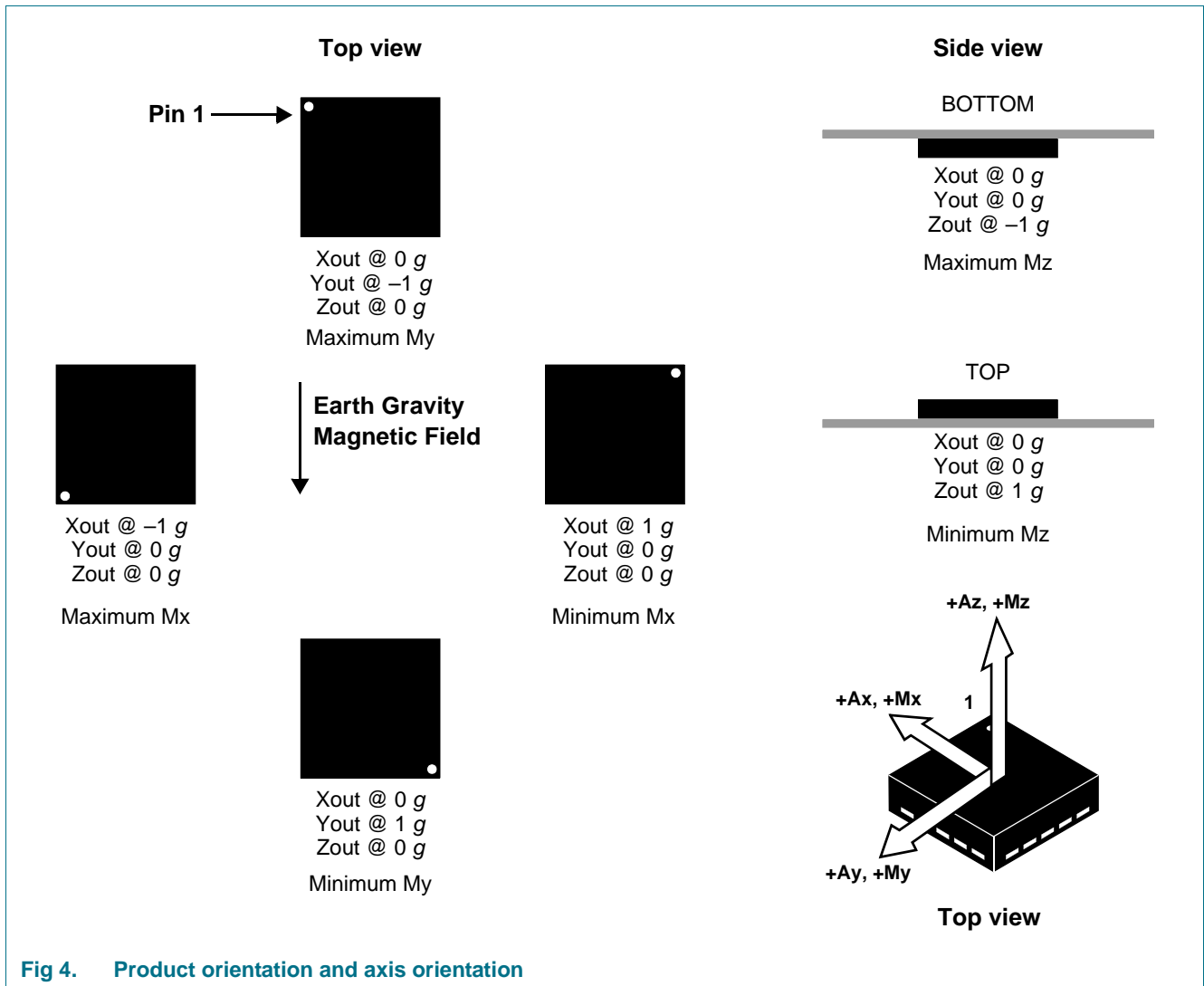

Fig 4. Product orientation and axis orientation

8. Terminology

8.1 Sensitivity

Sensitivity is represented in mg/LSB for the accelerometer and $\mu\text{T}/\text{LSB}$ for the magnetometer. The magnetometer sensitivity is fixed at $0.1 \mu\text{T}/\text{LSB}$. The accelerometer sensitivity changes with the full-scale range selected by the user. Accelerometer sensitivity is 0.244 mg/LSB in 2 g mode, 0.488 mg/LSB in 4 g mode, and 0.976 mg/LSB in 8 g mode.

8.2 Zero-g and zero-flux offset

For the accelerometer, zero-g offset describes the deviation of the output values from the ideal values when the sensor is stationary. With an accelerometer stationary on a level horizontal surface, the ideal output is 0 g for the X and Y axes, and 1 g for the Z-axis. The

deviation of each output from the ideal value is called zero-g offset. Offset is to some extent a result of stress on the sensor, and therefore, can slightly change after mounting the sensor onto a printed circuit board or exposing it to extensive mechanical stress. For the magnetometer, zero-flux offset describes the deviation of the output signals from zero when the device is shielded from external magnetic field sources (that is, inside a zero-Gauss chamber).

8.3 Self-test

Self-test can be used to verify the transducer and signal chain functionality without the need to apply an acceleration stimulus. When the accelerometer self-test is activated, an electrostatic actuation force is applied to the sensor, simulating a small acceleration. In this case the sensor X, Y, and Z outputs will exhibit a change in DC levels related to the selected full-scale range (sensitivity). When self-test is activated, the device output level is given by the algebraic sum of the signals produced by the acceleration acting on the sensor and by the electrostatic self-test force.

9. Device characteristics

9.1 Accelerometer mechanical characteristics

Table 3. Accelerometer mechanical characteristics @ VDD = 2.5 V, VDDIO = 1.8 V T = 25 °C unless otherwise noted.

Symbol	Parameter	Conditions	Min	Typ	Max	Unit	
FS _{ACC}	Measurement range	±2 g mode	[1]	-	±2	-	g
		±4 g mode		-	±4	-	
		±8 g mode		-	±8	-	
SEN _{ACC}	Sensitivity	±2 g mode		-	4096	-	LSB/g
				-	0.244	-	mg/LSB
		±4 g mode		-	2048	-	LSB/g
				-	0.488	-	mg/LSB
				-	1024	-	LSB/g
		-	0.976	-	mg/LSB		
TCS _{ACC}	Sensitivity change with temperature	±2 g, ±4 g, ±8 g modes	[1]	-	±0.01	-	%/°C
SEN-TOL _{ACC}	Sensitivity accuracy		-	±2.5	-	%SEN _{ACC}	
OFF _{ACC}	Zero-g level offset accuracy	±2 g, ±4 g, ±8 g modes	[2]	-	±20	-	mg
OFF _{ACC-PBM}	Zero-g level offset accuracy post-board mount	±2 g, ±4 g, ±8 g modes	[4]	-	±30	-	mg
TCO _{ACC}	Zero-g level change versus temperature	-40 °C to 85 °C	[1]	-	±0.2	-	mg/°C
NL _{ACC}	Nonlinearity (deviation from straight line)	Over ±1 g range normal mode	[5][6]	-	±0.5	-	%FS _{ACC}
STOC _{ACC}	Self-test output change		[7]				LSB
		±2 g mode, X-axis		+192	-	-	
		±2 g mode, Y-axis		+270	-	-	
		±2 g mode, Z-axis		+1275	-	-	

Table 3. Accelerometer mechanical characteristics @ VDD = 2.5 V, VDDIO = 1.8 V T = 25 °C unless otherwise noted. - *continued*

Symbol	Parameter	Conditions	Min	Typ	Max	Unit	
ND _{ACC}	Output noise density, normal mode	ODR = 400 Hz, normal mode	[4][7]	-	126	-	µg/√Hz
		ODR = 400 Hz, low-noise mode	[1]	-	99	-	µg/√Hz
T _{OP}	Operating temperature range		-40	-	+85	°C	

- [1] Dynamic range is limited to ±4 g when in the low-noise mode.
- [2] Before board mount.
- [3] Post-board mount offset specifications are based on a 2-layer PCB design.
- [4] Evaluation only.
- [5] After post-board mount corrections for sensitivity, cross axis and offset. Refer to NXP application note AN4399 for more information.
- [6] Self-test is only exercised along one direction for each sensitive axis.
- [7] Measured using earth's gravitational field (1 g) with the device oriented horizontally (+Z axis up) and stationary.

9.2 Magnetometer magnetic characteristics

Table 4. Magnetometer magnetic characteristics @ VDD = 2.5 V, VDDIO = 1.8 V T = 25 °C unless otherwise noted.

Symbol	Parameter	Conditions	Min	Typ	Max	Unit
FS _{MAG}	Measurement range	-	±1200	-	-	µT
SEN _{MAG}	Sensitivity	-	-	0.1	-	µT/LSB
TCS _{MAG}	Sensitivity change versus temperature	-	-	±0.1	-	%/°C
OFF _{MAG}	Zero-flux offset accuracy	-	[1]	±10	-	µT
TCO _{MAG}	Zero-flux offset change with temperature	-	-	±0.8	-	µT/°C
HYST _{MAG}	Hysteresis	-	[2][3]	±0.5	-	%FS _{MAG}
NL _{MAG}	Nonlinearity		[3]			
	Deviation from best-fit straight line	-	-	±1	-	%FS _{MAG}
-	Temperature sensor sensitivity	-	-	0.96	-	°C/LSB
Noise _{MAG}	Magnetometer output noise	ODR = 800 Hz, OSR = 2	-	1.5	-	µT-rms
		ODR = 400 Hz, OSR = 4	-	1.2	-	
		ODR = 200 Hz, OSR = 8	-	0.85	-	
		ODR = 100 Hz, OSR = 16	-	0.6	-	
		ODR = 50 Hz, OSR = 32	-	0.5	-	
		ODR = 12.5 Hz, OSR = 128	-	0.35	-	
		ODR = 6.25 Hz, OSR = 256	-	0.3	-	
	ODR = 1.56 Hz, OSR = 1024	-	0.3	-		
T _{OP}	Operating temperature range	-	-40	-	+85	°C

- [1] After m-cell has been factory trimmed.
- [2] Hysteresis is measured by sweeping the applied magnetic field from -1000 µT to 1000 µT and then back to -1000 µT. The difference in the two readings at -1000 µT divided by the swept field range is the hysteresis figure, expressed in % of the full-scale range (FS_{MAG}).
- [3] Tested over a ±1000 µT measurement range.

9.3 Hybrid characteristics

Table 5. Hybrid characteristics @ VDD = 2.5 V, VDDIO = 1.8 V T = 25 °C unless otherwise noted.

Symbol	Rating	Value	Unit	Symbol	Rating
ODR _{max}	Maximum output data rate in hybrid mode	-	400	-	Hz
T _{OP}	Operating temperature range	-40	-	+85	°C
BW	Output data bandwidth	-	ODR/2	-	Hz

9.4 Electrical characteristics

Table 6. Electrical characteristics @ VDD = 2.5 V, VDDIO = 1.8 V T = 25 °C unless otherwise noted.

Symbol	Parameter	Conditions	Min	Typ	Max	Unit
VDD	Supply voltage	-	1.95	2.5	3.6	V
VDDIO	Interface supply voltage	-	1.62	1.8	3.6	V
IDD _{ACC-LPM}	Supply current	Low-power acceleration mode				μA
		ODR = 12.5 Hz	-	8	-	
		ODR = 100 Hz	-	35	-	
		ODR = 400 Hz	-	130	-	
IDD _{ACC-NM}	Supply current	Normal acceleration mode				μA
		ODR = 50 Hz	-	35	-	
		ODR = 200 Hz	-	130	-	
		ODR = 800 Hz	-	240	-	
IDD _{ACC+MAG}	Supply current	Hybrid mode				μA
		ODR = 200 Hz	-	440	-	
		Accelerometer OSR = 4 Magnetometer OSR = 2				
		ODR = 100 Hz	-	240	-	
		Accelerometer OSR = 4 Magnetometer OSR = 2				
		ODR = 25 Hz	-	80	-	
IDD _{MAG}	Supply current	Magnetic mode				μA
		ODR = 400 Hz, OSR = 2	-	575	-	
		ODR = 12.5 Hz, OSR = 2	-	40	-	
IDD _{BOOT}	Supply current during boot sequence	0.9 ms max duration using recommended regulator bypass capacitor, VDD = 2.5 V	-	-	-	3
C _{BYP} , C _{RST}	Value of capacitors on BYP and magnetic reset pins	-40 °C to 85 °C	75	100	470	nF
IDD _{STBY}	Supply current	Standby mode @ 25 °C	-	2	-	μA
IDD _{STBY}	Supply current	Over-temperature range, standby mode	-	-	10	μA

Table 6. Electrical characteristics @ VDD = 2.5 V, VDDIO = 1.8 V T = 25 °C unless otherwise noted. - ¶continued -

Symbol	Parameter	Conditions	Min	Typ	Max	Unit
VIH _{RST}	Digital high-level input voltage, RST pin	-	1.04	-	-	V
VIL _{RST}	Digital low-level input voltage, RST pin	-	-	-	0.68	V
VIH	Digital high-level input voltage, SCL, SDA, SA0, and SA1 pins	-	0.75*VDDIO	-	-	V
VIL	Digital low-level input voltage, SCL, SDA, SA0, and SA1 pins	-	-	-	0.3*VDDIO	V
VOH	High-level output voltage, INT and INT2 pins	I _O = 500 µA	0.9*VDDIO	-	-	V
VOL	Low-level output voltage, INT1 and INT2 pins	I _O = 500 µA	-	-	0.1*VDDIO	V
VOL _{SDA}	Low-level output voltage, SDA pin	I _O = 500 µA	-	-	0.1*VDDIO	V
	SCL and SDA pin leakage	25 °C	-	1.0	-	nA
		-40 °C to 85 °C	-	4.0	-	
	SCL and SDA pin capacitance	-	-	3	-	pf
	VDD rise time	-	0.001	-	1000	ms
T _{BOOT}	Boot time	-	[1]	-	1000	µs
T _{POR→ACT}	Turn-on time 1	-	[2]	2/ODR + 2	-	ms
T _{STBY→ACT}	Turn-on time 2	-	[3]	2/ODR + 1	-	ms
T _{OP}	Operating temperature range	-	-40	-	+85	°C

- [1] Time from VDDIO on and VDD > VDD min until I²C/SPI interface ready for operation.
- [2] Time to obtain valid data from power-down mode to active mode.
- [3] Time to obtain valid data from standby mode to active mode.

Table 7. IDD (µA) table versus operating modes (VDD + VDDIO), VDD = VDDIO = 2.4 V [1]

Legend: NM = Accelerometer OSR Normal Mode (CTRL_REG2[mods] = 0b00);
 LP = Accelerometer OSR Low Power (CTRL_REG2[mods] = 0b11);
 OS0 = Magnetometer OSR set to 0 (M_CTRL_REG1[m_os] = 0b000);
 OS7 = Magnetometer OSR set to 7 (M_CTRL_REG1[m_os] = 0b111).

Mode	Acc only		Mag only		Hybrid		
	NM	LP	OS0	OS7	NM/OS0	LP/OS0	NM/OS7
800	239	239	1072	1072			
400	239	121	552	1002	648	647	648
200	121	62	289	966	412	339	607
100	68	33	156	947	220	183	512
50	33	18	90	939	123	105	465
25					74	66	442
12.5	33	7	37	932			

Table 7. IDD (µA) table versus operating modes (VDD + VDDIO), VDD = VDDIO = 2.4 V ^[1] - ¶*continued*

Legend: NM = Accelerometer OSR Normal Mode (CTRL_REG2[mods] = 0b00);
 LP = Accelerometer OSR Low Power (CTRL_REG2[mods] = 0b11);
 OS0 = Magnetometer OSR set to 0 (M_CTRL_REG1[m_os] = 0b000);
 OS7 = Magnetometer OSR set to 7 (M_CTRL_REG1[m_os] = 0b111).

Mode	Acc only		Mag only		Hybrid		
	NM	LP	OS0	OS7	NM/OS0	LP/OS0	NM/OS7
6.25	33	7	37	931	51	35	437
3.125					51	35	437
1.5625	33	7	36	931			
0.78125					51	35	436
stby				2			

[1] Values are based on limited number of samples and are for reference only. Output data rates do not exist for the shaded cells.

9.5 Absolute maximum ratings

Stresses above those listed as “absolute maximum ratings” may cause permanent damage to the device. This is a stress rating only and functional operation of the device under these conditions is not implied. Exposure to maximum rating conditions for extended periods may affect device reliability.

NXP recommends that customers using magnetic sensor components adopt industry standard safe handling practices and procedures for magnetic products. To avoid potential damage to the magnetic transducer contained within this product, it is recommended to only handle the device with non-magnetic tools and fixtures.

Table 8. Maximum ratings

Symbol	Rating	Value	Unit
g_{max}	Maximum acceleration (all axes, 100 µs)	10 000	<i>g</i>
VDD_{max}	Supply voltage, interface supply voltage	-0.3 to +3.6	V
$VDDIO_{max}$	Supply voltage, IO voltage	-0.3 to +3.6	V
VIN_{max}	Input voltage on any control pin (SA0/MISO, SA1/CS_B, SCL/SCLK, SDA/MOSI, RST)	-0.3 to VDDIO + 0.3	V
D_{drop}	Drop-test height	1.8	m
-	Maximum exposed magnetic field without perming	^[1] 3000	µT
-	Maximum exposed field without permanent damage	0.1	T
T_{STG}	Storage temperature range	-40 to +125	°C

[1] Sensor characteristics can be restored on a “permed” device by means of briefly applying an external uniform magnetic field on the order of 100 Gauss or greater, along the X-axis.

Table 9. ESD and latchup protection characteristics

Symbol	Rating	Value	Unit
HBM	Human body model	±2000	V
MM	Machine model	±200	V

Table 9. ESD and latchup protection characteristics - ¶continued

Symbol	Rating	Value	Unit
CDM	Charge device model	±500	V
I _{LU}	Latchup current at T = 85 °C	±100	mA



This device is sensitive to mechanical shock. Improper handling can cause permanent damage to the part or cause the part to otherwise fail.



This device is sensitive to ESD, improper handling can cause permanent damage to the part.

10. Digital interfaces

10.1 I²C interface characteristics

Table 10. I²C slave timing values^[1]

Symbol	Parameter	I ² C fast mode		Unit
		Min	Max	
f _{SCL}	SCL clock frequency	0	400	kHz
t _{BUF}	Bus free time between stop and start condition	1.3	-	µs
t _{HD;STA}	(Repeated) start hold time	0.6	-	µs
t _{SU;STA}	(Repeated) start setup time	0.6	-	µs
t _{SU;STO}	STOP condition setup time	0.6	-	µs
t _{HD;DAT}	SDA data hold time ^[2]	0.05	0.9	µs
t _{VD;DAT}	SDA valid time ^{[2][3]}	-	0.9	µs
t _{VD;ACK}	SDA valid acknowledge time ^{[2][4]}	-	0.9	µs
t _{SU;DAT}	SDA setup time	100	-	ns
t _{LOW}	SCL clock low time	1.3	-	µs
t _{HIGH}	SCL clock high time	0.6	-	µs
t _r	SDA and SCL rise time ^[5]	20 + 0.1 C _b	300	ns
t _f	SDA and SCL fall time ^[5]	20 + 0.1 C _b	300	ns
t _{SP}	Pulse width of spikes on SDA and SCL that must be suppressed by internal input filter	0	50	ns

[1] All values referred to V_{IH} (min) and V_{IL} (max) levels

[2] This device does not stretch the low period (t_{LOW}) of the SCL signal.

[3] t_{VD;DAT} = time for data signal from SCL low to SDA output.

[4] t_{VD;ACK} = time for acknowledgement signal from SCL low to SDA output (high or low, depending on which one is worse)

[5] C_b = total capacitance of one bus line in pF.

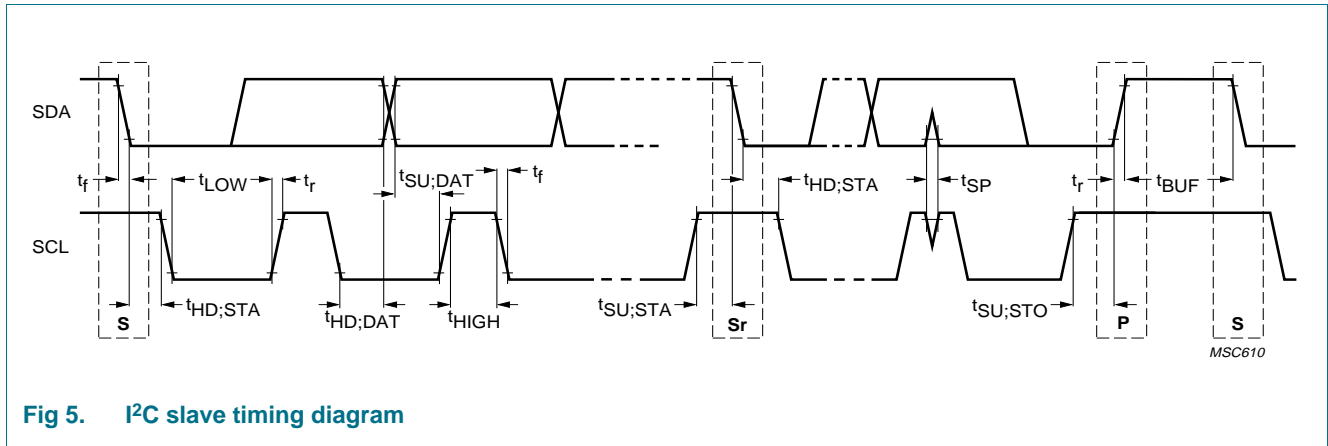

Fig 5. I2C slave timing diagram

10.1.1 General I2C operation

There are two signals associated with the I2C bus: the serial clock line (SCL) and the serial data line (SDA). The latter is a bidirectional line used for sending and receiving the data to/from the interface. External pullup resistors connected to VDDIO are required for SDA and SCL. When the bus is free both the lines are high. The I2C interface is compliant with fast mode (400 kHz), and normal mode (100 kHz) I2C standards. Operation at frequencies higher than 400 kHz is possible, but depends on several factors including the pullup resistor values, and total bus capacitance (trace + device capacitance). See [Table 11](#) for more information.

A transaction on the bus is started through a start condition (ST) signal, which is defined as a high-to-low transition on the data line while the SCL line is held high. After the ST signal has been transmitted by the master, the bus is considered busy. The next byte of data transmitted contains the slave address in the first seven bits, and the eighth bit, the read/write bit, indicates whether the master is receiving data from the slave or transmitting data to the slave. When an address is sent, each device in the system compares the first seven bits after the ST condition with its own address. If they match, the device considers itself addressed by the master. The ninth clock pulse, following the slave address byte (and each subsequent byte) is the acknowledge (ACK). The transmitter must release the SDA line during the ACK period. The receiver must then pull the data line low so that it remains stable low during the high period of the acknowledge clock period.

The number of bytes per transfer is unlimited. If a receiver can't receive another complete byte of data until it has performed some other function, it can hold the clock line, SCL low to force the transmitter into a wait state. Data transfer only continues when the receiver is ready for another byte and releases the data line. This delay action is called clock stretching. Not all receiver devices support clock stretching. Not all master devices recognize clock stretching. This part does not use clock stretching.

A low to high transition on the SDA line while the SCL line is high is defined as a stop condition (SP) signal. A write or burst write is always terminated by the master issuing the SP signal. A master should properly terminate a read by not acknowledging a byte at the appropriate time in the protocol. A master may also issue a repeated start signal (Sr) during a transfer

The slave addresses that may be assigned to the FXOS8700CQ part are 0x1C, 0x1D, 0x1E, or 0x1F. The selection is made through the logic level of the SA1 and SA0 inputs.

Table 11. I²C slave address

SA1	SA0	Slave address
0	0	0x1E
0	1	0x1D
1	0	0x1C
1	1	0x1F

10.1.2 I²C read/write operations

Single-byte read

The master (or MCU) transmits a start condition (ST) to the FXOS8700CQ, followed by the slave address, with the R/W bit set to “0” for a write, and the FXOS8700CQ sends an acknowledgement. Then the master (or MCU) transmits the address of the register to read and the FXOS8700CQ sends an acknowledgement. The master (or MCU) transmits a repeated start condition (SR), followed by the slave address with the R/W bit set to “1” for a read from the previously selected register. The FXOS8700CQ then acknowledges and transmits the data from the requested register. The master does not acknowledge (NAK) the transmitted data, but transmits a stop condition to end the data transfer.

When performing a multi-byte or “burst” read, the FXOS8700CQ automatically increments the register address read pointer after a read command is received. Therefore, after following the steps of a single-byte read, multiple bytes of data can be read from sequential registers after each FXOS8700CQ acknowledgment (AK) is received until a no acknowledge (NAK) occurs from the master followed by a stop condition (SP) signaling an end of transmission.

Single-byte write

To start a write command, the master transmits a start condition (ST) to the FXOS8700CQ, followed by the slave address with the R/W bit set to “0” for a write, and the FXOS8700CQ sends an acknowledgement. Then the master (or MCU) transmits the address of the register to write to, and the FXOS8700CQ sends an acknowledgement. Then the master (or MCU) transmits the 8-bit data to write to the designated register and the FXOS8700CQ sends an acknowledgement that it has received the data. Since this transmission is complete, the master transmits a stop condition (SP) to end the data transfer. The data sent to the FXOS8700CQ is now stored in the appropriate register.

Multiple-byte write

The FXOS8700CQ automatically increments the register address write pointer after a write command is received. Therefore, after following the steps of a single-byte write, multiple bytes of data can be written to sequential registers after each FXOS8700CQ acknowledgment (ACK) is received.

< Single-byte read >

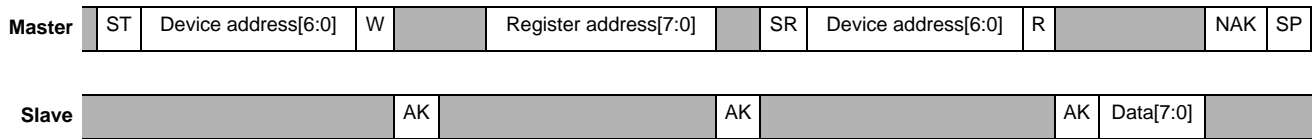

< Multiple-byte read >

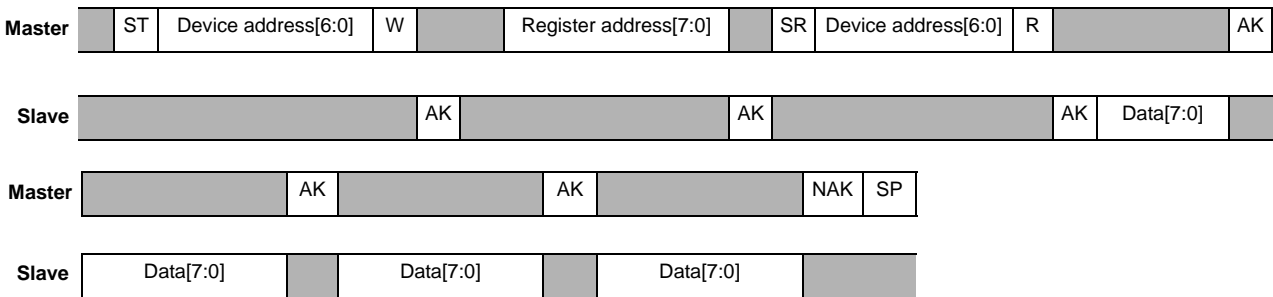

< Multiple-byte write >

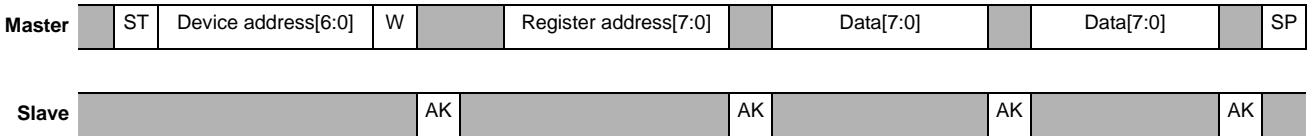

< Single-byte write >

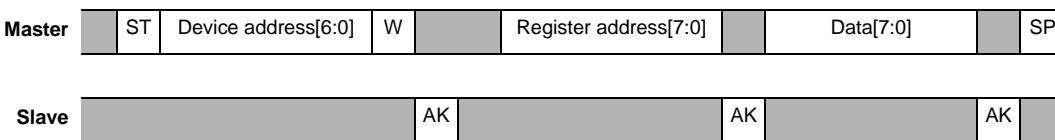

Legend

ST: Start condition SP: Stop condition NAK: No acknowledge W: Write = 0
 SR: Repeated start condition AK: Acknowledge R: Read = 1

Fig 6. I²C timing diagram

10.2 SPI interface characteristics

SPI interface is a classical master/slave serial port. The FXOS8700CQ is always considered as the slave and thus is never initiating the communication.

Table 12 and Figure 7 describe the timing requirements for the SPI system.

Table 12. SPI timing

Function	Symbol	Min	Max	Unit
Operating frequency	<i>Of</i>	-	1	MHz
SCLK period	tSCLK	1000	-	ns
SCLK high time	tCLKH	500	-	ns
SCLK low time	tCLKL	500	-	ns
CS_B lead time	tSCS	65	-	ns
CS_B lag time	tHCS	65	-	ns
MOSI data setup time	tSET	25	-	ns

Table 12. SPI timing

Function	Symbol	Min	Max	Unit
MOSI data hold time	tHOLD	75	-	ns
MISO data valid (after SCLK low edge)	tDDLY	-	500	ns
Width CS high	tWCS	100	-	ns

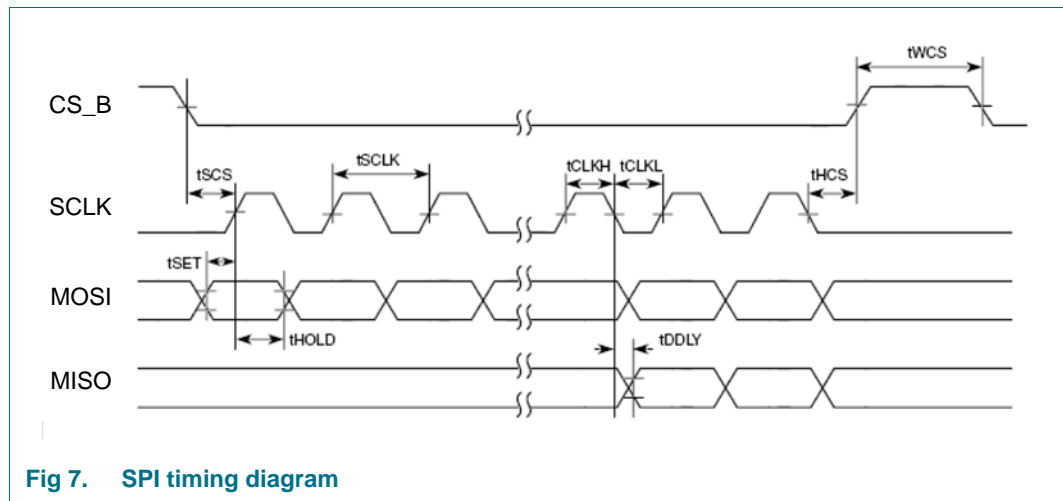

Fig 7. SPI timing diagram

10.2.1 General SPI operation

NOTE

FXOS8700CQ only supports a point-to-point SPI protocol, with only one master (MCU) and one slave device (FXOS8700CQ) present on the bus. FXOS8700CQ does not tri-state the MISO pin when the CS_B pin is deasserted (logic high), which can lead to a bus conflict if multiple slave devices are present on the bus.

Do not connect more than one master and one slave device on the SPI bus.

The CS_B pin is driven low at the start of a SPI transaction, held low for the duration of the transaction, and driven high after the transaction is complete. During a transaction the master toggles the SPI clock (SCLK) and transmits data on the MOSI pin.

A write operation is initiated by transmitting a 1 for the R/W bit. Then the 8-bit register address, ADDR[7:0] is encoded in the first and second serialized bytes. Data to be written starts in the third serialized byte. The order of the bits is as follows:

- Byte 0: R/W, ADDR[6], ADDR[5], ADDR[4], ADDR[3], ADDR[2], ADDR[1], ADDR[0],
- Byte 1: ADDR[7], X, X, X, X, X, X, X,
- Byte 2: DATA[7], DATA[6], DATA[5], DATA[4], DATA[3], DATA[2], DATA[1], DATA[0].

Multiple bytes of DATA may be transmitted. The X indicates a bit that is ignored by the part. The register address is auto-incremented so that the next clock edges will latch the data for the next register. When desired, the rising edge on CS_B stops the SPI communication.

The FXOS8700CQ SPI configuration is as follows:

- Polarity: rising/falling
- Phase: sample/setup
- Order: MSB first

Data is sampled during the rising edge of SCLK and set up during the falling edge of SCLK.

10.2.2 SPI read/write operations

A read operation is initiated by transmitting a 0 for the R/W bit. Then the 8-bit register address, ADDR[7:0] is encoded in the first and second serialized bytes. Subsequent bits are ignored by the part. The read data is deserialized from the MISO pin.

Similarly a write operation is initiated by transmitting a 1 for the R/W bit. After the first and second serialized bytes multiple-data bytes can be transmitted into consecutive registers, starting from the indicated register address in ADDR[7:0].

An SPI transaction is started by asserting the CS_B pin (high-to-low transition), and ended by deasserting the CS_B pin (low-to-high transition).

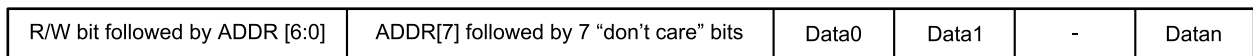

- (1) Data bytes must be transmitted to the slave (FXOS8700CQ) using the MOSI pin by the master when R/W = 1. Data bytes will be transmitted by the slave (FXOS8700CQ) to the master using the MISO pin when R/W = 0. The first two bytes are always transmitted by the master using the MOSI pin. That is, a transaction is always initiated by master.

Fig 8. SPI single-burst read/write transaction diagram

The registers embedded inside FXOS8700CQ are accessed through either an I²C, or a SPI serial interface. To enable either interface the VDDIO line must be connected to the interface supply voltage. If VDD is not present and VDDIO is present FXOS8700CQ is in shutdown mode and communications on the interface are ignored. If VDDIO is held high, VDD can be powered off and the communications pins will be in a high impedance state. This will allow communications to continue on the bus with other devices.

Table 13. Serial interface pin descriptions

Pin name	Pin description
VDDIO	Digital interface power
SA1/CS_B	I ² C second least significant bit of device address/SPI chip select
SCL/SCLK	I ² C/SPI serial clock
SDA/MOSI	I ² C serial data/SPI master serial data out slave serial data in
SA0/MISO	I ² C least significant bit of the device address/SPI master serial data in slave out

10.2.3 I²C/SPI auto detection

Table 14. I²C/SPI auto detection

SA0	Slave address
GND	I ² C
VDDIO	I ² C
Floating	SPI

FXOS8700CQ employs an interface mode, auto-detection circuit that will select either I²C or SPI interface mode based on the state of the SA0 pin during power up or when exiting reset. Once set for I²C or SPI operation, the device will remain in I²C or SPI mode until the device is reset or powered down and the auto-detection process is repeated. Please note that when SPI interface mode is desired, care must be taken to ensure that no other slave device drives the common SA0/MISO pin during the 1 ms period after a hard or soft reset or powerup event.

10.2.4 Power supply sequencing and I²C/SPI mode auto-detection

FXOS8700CQ does not have any specific power supply sequencing requirements between VDD and VDDIO voltage supplies to ensure normal operation. To ensure correct operation of the I²C/SPI auto-detection function, VDDIO should be applied before or at the same time as VDD. If this order cannot be maintained, the user should either toggle the RST line or power cycle the VDD rail in order to force the auto-detect function to restart and correctly identify the desired interface. FXOS8700CQ will indicate completion of the reset sequence by toggling the INT1 pin from logic high to low to high over a 500 ns period. If the INT1 pin was already low prior to the reset event, it will only go high.

11. Modes of operation

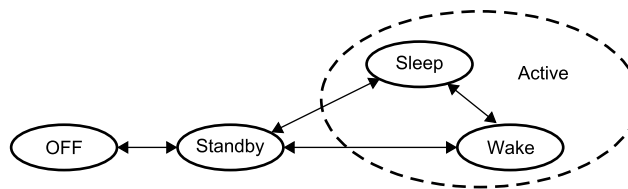

Fig 9. FXOS8700CQ power mode transition diagram

Table 15. Mode of operation description

Mode	I ² C/SPI bus state	VDD	VDDIO	Function description
OFF	Powered down	<1.8 V	VDDIO can be > VDD	The device is powered off. All analog and digital blocks are shutdown. I ² C bus inhibited.
Standby	I ² C/SPI communication with FXOS8700CQ is possible	ON	VDDIO = High VDD = High Active bit is cleared	Only digital blocks are enabled. Analog subsystem is disabled. Internal clocks disabled.
Active (wake/sleep)	I ² C/SPI communication with FXOS8700CQ is possible	ON	VDDIO = High VDD = High Active bit is set	All blocks are enabled (digital and analog).

All register contents are preserved when transitioning from active-to-standby mode, but some registers are reset when transitioning from standby-to-active. These registers are noted in [Table 16](#). The sleep and wake modes are active modes. For more information on how to use the sleep and wake modes and configuring the device to transition between them, please refer to [Section 12](#) or NXP application note AN4074.

12. Embedded functionality

FXOS8700CQ is a low-power, digital output, 6-axis sensor with both I²C and SPI interfaces. Extensive embedded functionality is provided to detect inertial and magnetic events at low power, with the ability to notify the host processor of an event using either of the two programmable interrupt pins. The embedded functionality includes:

- 8-bit or 14-bit accelerometer data which includes high-pass filtered data, and 8-bit or 16-bit magnetometer data
- Four different oversampling options for the accelerometer output data, and eight for the magnetometer. The oversampling settings allow the end user to optimize the resolution versus power trade-off in a given application.
- A low-noise accelerometer mode that functions independently of the oversampling modes for even higher resolution
- Low-power, auto-wake/sleep function for conserving power in portable battery powered applications
- Accelerometer pulse-detection circuit which can be used to detect directional single and double taps
- Accelerometer directional motion- and freefall-event detection with programmable threshold and debounce time
- Acceleration transient detection with programmable threshold and debounce time. Transient detection can employ either a high-pass filter or use the difference between reference and current sample values.
- Orientation detection with programmable hysteresis for smooth transitions between portrait/landscape orientations
- Accelerometer vector-magnitude change event detection with programmable reference, threshold, and debounce time values
- Magnetic threshold event detection with programmable reference, threshold, and debounce time
- Magnetometer vector-magnitude change event detection with programmable reference, threshold and debounce time values
- Magnetic min/max detection circuit which can also be used for autonomous calibration of magnetic hard-iron offset

Many different configurations of the above functions are possible to suit the needs of the end application. Separate application notes are available to further explain the different configuration settings and potential use cases.

12.1 Factory calibration

FXOS8700CQ's integrated accelerometer and magnetometer sensors are factory calibrated for sensitivity and offset on each axis. The trim values are stored in non-volatile memory (NVM). On power-up, the trim parameters are read from NVM and applied to the internal compensation circuitry. After mounting the device to the PCB, the user may

further adjust the accelerometer and magnetometer offsets through the OFF_X/Y/Z and M_OFF_X/Y/Z registers, respectively. For more information on device calibration, refer to NXP application note, AN4399.

12.2 8-bit or 14-bit accelerometer data

The measured acceleration data is stored in the OUT_X_MSB, OUT_X_LSB, OUT_Y_MSB, OUT_Y_LSB, OUT_Z_MSB, and OUT_Z_LSB registers as 2's complement 14-bit numbers. The most significant 8-bits of each axis are stored in the OUT_X/Y/Z_MSB registers, so applications needing only 8-bit results simply read these three registers and ignore the OUT_X/Y/Z_LSB registers. To do this, the f_read mode bit in CTRL_REG1 must be set.

When the full-scale range is set to 2 g, the measurement range is -2 g to $+1.999\text{ g}$, and each count corresponds to 0.244 mg at ± 14 -bits resolution. When the full-scale is set to 8 g, the measurement range is -8 g to $+7.996\text{ g}$, and each count corresponds to 0.976 mg. The resolution is reduced by a factor of 64 if only the 8-bit results are used (CTRL_REG1[f_read] = 1). For further information on the different data formats and modes, please refer to NXP application note AN4076.

12.3 Accelerometer low-power modes versus high-resolution modes

FXOS8700CQ can be optimized for lower power or higher resolution of the accelerometer output data. High resolution is achieved by setting the Inoise bit in register 0x2A. This improves the resolution (by lowering the noise), but be aware that the full-scale range setting is restricted to $\pm 2\text{ g}$ or $\pm 4\text{ g}$ when this bit is set. This will affect all internal embedded functions (scaling of thresholds, etc.) and reduce noise. Another method for improving the resolution of the data is through oversampling. One of the oversampling schemes of the output data can be activated when CTRL_REG2[mods] = 0b10 which will improve the resolution of the output data without affecting the internal embedded functions or fixing the dynamic range.

There is a trade-off between low power and high resolution. Low power can be achieved when the oversampling rate is reduced. When CTRL_REG2[mods] = 0b10, the lowest power is achieved, at the expense of higher noise. In general, the lower the selected ODR and OSR, the lower the power consumption. For more information on how to configure the device in low-power or high-resolution modes and understand the benefits and trade-offs, please refer to NXP application note AN4075.

12.4 Auto-wake/sleep mode

FXOS8700CQ can be configured to transition between sample rates (with their respective current consumptions) based on the status of the embedded interrupt event generators in the device. The advantage of using the auto-wake/sleep is that the system can automatically transition to a higher sample rate (higher current consumption) when needed but spends the majority of the time in the sleep mode (lower current) when the device does not require higher sampling rates. Auto-wake refers to the device being triggered by one of the interrupt event functions to transition to a higher sample rate. This may also interrupt the processor to transition from a sleep mode to a higher power mode.

Sleep mode occurs when none of the enabled interrupt event functions has detected an interrupt within the user-defined, time-out period. The device will then transition to the specified lower sample rate. It may also alert the processor to go into a lower power mode to save power during this period of inactivity. Refer to AN4074 for more detailed information on configuring the auto-wake/sleep function.

12.5 Hybrid mode

FXOS8700CQ uses a single common analog-to-digital converter (ADC) for both the accelerometer and magnetometer. When operating in hybrid mode ($M_CTRL_REG1[m_hms] = 0b11$), both the accelerometer and magnetometer sensors are actively measured by the ADC at an ODR equal to one half of the setting made in $CTRL_REG1[dr]$ when operating in accelerometer-only mode ($M_CTRL_REG1[m_hms] = 0b00$ (default)) or magnetometer-only mode ($M_CTRL_REG1[m_hms] = 0b01$). While the ODR is common to both sensors when operating in hybrid mode, the OSR settings for each sensor are independent and may be set using the $CTRL_REG2[mods]$ for the accelerometer and $M_CTRL_REG1[m_os]$ for the magnetometer, respectively.

12.6 Accelerometer freefall and motion event detection

FXOS8700CQ integrates a programmable threshold based acceleration detection function capable of detecting either motion or freefall events depending upon the configuration. For further details and examples on using the embedded freefall and motion detection functions, refer to NXP application note AN4070.

12.6.1 Freefall detection

The detection of “Freefall” involves the monitoring of the X, Y, and Z axes for the condition where the acceleration magnitude is *below* a user-specified threshold for a user-definable amount of time. Typically, the usable threshold ranges are between ± 100 mg and ± 500 mg.

12.6.2 Motion detection

Motion detection is often used to alert the main processor that the device is currently in use. When the acceleration exceeds a set threshold for a set amount of time, the motion interrupt is asserted. A motion can be a fast moving shake or a slow moving tilt. This will depend on the threshold and timing values configured for the event. The motion detection function can analyze static acceleration changes or faster jolts. The timing value is set by a configurable debounce counter. The debounce counter acts like a filter to indicate whether the condition exists for longer than a set amount of time (that is, 100 ms or longer). There is also directional data available in the source register to detect the direction of the motion that generated the interrupt. This is useful for applications such as directional shake or flick detection, and can also assist gesture detection algorithms by indicating that a motion gesture has started.

12.7 Transient detection

FXOS8700CQ integrates an acceleration transient detection function that incorporates a high-pass filter. Acceleration data goes through the high-pass filter, eliminating the DC tilt offset and low frequency acceleration changes. The high-pass filter cutoff can be set by the user to four different frequencies which are dependent on the selected output data

rate (ODR). A higher cutoff frequency ensures that DC and slowly changing acceleration data will be filtered out, allowing only the higher frequencies to pass. The transient detection feature can be used in the same manner as the motion detection by bypassing the high-pass filter. There is an option in the configuration register to do this. This adds more flexibility to cover the various customer use cases.

Many applications use the accelerometer's static acceleration readings (that is, tilt) which measure the change in acceleration due to gravity only. These functions benefit from acceleration data being filtered with a low-pass filter where high-frequency data is considered noise. However, there are many functions where the accelerometer must analyze dynamic acceleration. Functions such as tap, flick, shake and step counting are based on the analysis of the change in the dynamic acceleration. The transient detection function can be routed to either interrupt pin through bit 5 in CTRL_REG5 register (0x2E). Registers 0x1D – 0x20 are used for configuring the transient detection function. The source register contains directional data to determine the direction of the transient acceleration, either positive or negative. For further information of the embedded transient detection function along with specific application examples and recommended configuration settings, refer to NXP application note AN4461.

12.8 Pulse detection

FXOS8700CQ has embedded single/double and directional pulse detection. This function employs several timers for programming the pulse width time and the latency between pulses. The detection thresholds are independently programmable for each axis. The acceleration data input to the pulse detection circuit can be put through both high and low-pass filters, allowing for greater flexibility in discriminating between pulse and tap events. The PULSE_SRC register provides information on the axis, direction (polarity), and single/double event status for the detected pulse or tap. For more information on how to configure the device for pulse detection, please refer to NXP application note AN4072.

12.9 Orientation detection

FXOS8700CQ has an embedded orientation detection algorithm with the ability to detect all six orientations. The transition angles and hysteresis are programmable, allowing for a smooth transition between portrait and landscape orientations.

The angle at which the device no longer detects the orientation change is referred to as the "Z-lockout angle". The device operates down to 29° from the flat position. All angles are accurate to $\pm 2^\circ$.

For further information on the orientation detection function refer to NXP application note, AN4068.

12.10 Acceleration vector-magnitude detection

FXOS8700CQ incorporates an acceleration vector-magnitude change detection block that can be configured to generate an interrupt when the acceleration magnitude exceeds a preset threshold for a programmed debounce time. The function can be configured to operate in absolute or relative modes, and can also act as a wake-to-sleep/sleep-to-wake source. This function is useful for detecting acceleration transients when operated in absolute mode, or for detecting changes in orientation when operated in relative mode, refer to NXP application note AN4692.

12.11 Magnetic vector-magnitude detection

FXOS8700CQ incorporates a magnetic vector-magnitude change detection block that can be configured to generate an interrupt when the magnetic field magnitude exceeds a preset threshold for a programmed debounce time. The function can be configured to operate in absolute or relative modes, and can also act as a wake-to-sleep/sleep-to-wake source. For more information, refer to NXP application note AN4458.

12.12 Magnetic threshold detection

FXOS8700CQ incorporates a magnetic threshold event detection block that can be configured to generate an interrupt when the magnetic field on the enabled axes is above or below a programmed threshold.

Two logic combinations are possible for the detection: all of the enabled axes below their respective thresholds (AND condition), or any of the enabled axes above their respective thresholds (OR condition). Even detection may be filtered using a dedicated debounce counter to avoid spurious event detection. The thresholds for each axis are individually programmable and the function can also act as a wake-to-sleep/sleep-to-wake source.

12.13 Magnetic min/max detection (autonomous calibration)

FXOS8700CQ incorporates a magnetic min/max detection circuit that can be used to automatically track the minimum and maximum field values measured on each of the X, Y, and Z axes. The stored minimum and maximum values may optionally be used to determine the magnetic hard-iron compensation and load the offset registers with the appropriate correction values. For more information, refer to NXP application note AN4459.

13. Example FXOS8700CQ driver code

13.1 Introduction

It is very straightforward to configure the FXOS8700CQ and start receiving data from the three accelerometer and three magnetometer channels. Unfortunately, since every hardware platform will be different, it is not possible to provide completely portable software drivers. This section therefore provides real FXOS8700CQ driver code for a Kinetis uC board running under the MQX operating system. The I²C functions `s_i2c_read_regs` and `s_i2c_write_regs` are not provided here and should be replaced with the corresponding low level I²C driver code on the development platform.

13.2 FXOS8700CQ addresses

This section lists the I²C address of the FXOS8700CQ. The I²C address depends on the logic level of FXOS8700CQ's SA0 and SA1 address selection pins, so the actual I²C address may be 0x1C, 0x1D, 0x1E or 0x1F.

Please see [Table 11, "I²C slave address," on page 15](#) for the available I²C addresses and SA1/SA0 settings.

Example 1.

```
// FXOS8700CQ I2C address
#define FXOS8700CQ_SLAVE_ADDR    0x1E    // with pins SA0=0, SA1=0
```

Some of the key FXOS8700CQ internal register addresses are listed below.

Example 2.

```
// FXOS8700CQ internal register addresses
#define FXOS8700CQ_STATUS        0x00
#define FXOS8700CQ_WHOAMI       0x0D
#define FXOS8700CQ_XYZ_DATA_CFG 0x0E
#define FXOS8700CQ_CTRL_REG1    0x2A
#define FXOS8700CQ_M_CTRL_REG1  0x5B
#define FXOS8700CQ_M_CTRL_REG2  0x5C
#define FXOS8700CQ_WHOAMI_VAL   0xC7
```

The reference driver code shown in this example does a block read of the FXOS8700CQ status byte and three 16-bit accelerometer channels plus three 16-bit magnetometer channels for a total of 13 bytes in a single I²C read operation.

Example 3.

```
// number of bytes to be read from the FXOS8700CQ
#define FXOS8700CQ_READ_LEN     13    // status plus 6 channels = 13 bytes
```

13.3 Sensor data structure

The high and low bytes of the three accelerometer and three magnetometer channels are placed into a structure of type SRAWDATA containing three signed short integers.

Example 4.

```
typedef struct
{
    int16_t  x;
    int16_t  y;
    int16_t  z;
} SRAWDATA;
```

13.4 FXOS8700CQ configuration function

This function configures the FXOS8700CQ for 200-Hz hybrid mode meaning that both accelerometer and magnetometer data are provided at the 200-Hz rate. The code is self-explanatory and can be easily customized for different settings.

Example 5.

```
// function configures FXOS8700CQ combination accelerometer and
magnetometer sensor static _mqx_ints_FXOS8700CQ_start(MQX_FILE_PTR
aFP)
{
    uint8_t databyte;

    // read and check the FXOS8700CQ WHOAMI register
    if (s_i2c_read_regs(aFP, FXOS8700CQ_SLAVE_ADDR,
FXOS8700CQ_WHOAMI, &databyte,
        (uint8_t) 1) != 1)
    {
        return (I2C_ERROR);
    }
    if (databyte != FXOS8700CQ_WHOAMI_VAL)
    {
        return (I2C_ERROR);
    }

    // write 0000 0000 = 0x00 to accelerometer control register 1 to
place FXOS8700CQ into
    // standby
    // [7-1] = 0000 000
    // [0]: active=0
    databyte = 0x00;
    if (s_i2c_write_regs(aFP, FXOS8700CQ_SLAVE_ADDR,
FXOS8700CQ_CTRL_REG1, &databyte,
        (uint8_t) 1) != 1)
    {
        return (I2C_ERROR);
    }

    // write 0001 1111 = 0x1F to magnetometer control register 1
    // [7]: m_acal=0: auto calibration disabled
    // [6]: m_rst=0: no one-shot magnetic reset
```

```

    // [5]: m_ost=0: no one-shot magnetic measurement
    // [4-2]: m_os=111=7: 8x oversampling (for 200Hz) to reduce
magnetometer noise
    // [1-0]: m_hms=11=3: select hybrid mode with accel and
magnetometer active
    databyte = 0x1F;
    if (s_i2c_write_regs(aFP, FXOS8700CQ_SLAVE_ADDR,
FXOS8700CQ_M_CTRL_REG1,
        &databyte, (uint8_t) 1) != 1)
    {
        return (I2C_ERROR);
    }

    // write 0010 0000 = 0x20 to magnetometer control register 2
    // [7]: reserved
    // [6]: reserved
    // [5]: hyb_autoinc_mode=1 to map the magnetometer registers to
follow the
    // accelerometer registers
    // [4]: m_maxmin_dis=0 to retain default min/max latching even
though not used
    // [3]: m_maxmin_dis_ths=0
    // [2]: m_maxmin_rst=0
    // [1-0]: m_rst_cnt=00 to enable magnetic reset each cycle
    databyte = 0x20;
    if (s_i2c_write_regs(aFP, FXOS8700CQ_SLAVE_ADDR,
FXOS8700CQ_M_CTRL_REG2,
        &databyte, (uint8_t) 1) != 1)
    {
        return (I2C_ERROR);
    }

    // write 0000 0001= 0x01 to XYZ_DATA_CFG register
    // [7]: reserved
    // [6]: reserved
    // [5]: reserved
    // [4]: hpf_out=0
    // [3]: reserved
    // [2]: reserved
    // [1-0]: fs=01 for accelerometer range of +/-4g range with
0.488mg/LSB
    databyte = 0x01;
    if (s_i2c_write_regs(aFP, FXOS8700CQ_SLAVE_ADDR,
FXOS8700CQ_XYZ_DATA_CFG,
        &databyte, (uint8_t) 1) != 1)
    {
        return (I2C_ERROR);
    }

    // write 0000 1101 = 0x0D to accelerometer control register 1
    // [7-6]: aslp_rate=00
    // [5-3]: dr=001 for 200Hz data rate (when in hybrid mode)
    // [2]: lnoise=1 for low noise mode

```

```

    // [1]: f_read=0 for normal 16 bit reads
    // [0]: active=1 to take the part out of standby and enable
sampling
    databyte = 0x0D;
    if (s_i2c_write_regs(aFP, FXOS8700CQ_SLAVE_ADDR,
FXOS8700CQ_CTRL_REG1, &databyte,
        (uint8_t) 1) != 1)
    {
        return (I2C_ERROR);
    }

    // normal return
    return (I2C_OK);
}

```

13.5 Data read function

This function performs a block read of the status, accelerometer and magnetometer measurement registers and places the bytes read into the structures of type SRAWDATA as signed short integers.

Note that this function assumes that the `hyb_autoinc_mode` bit has been set to enable the reading of all accelerometer and magnetometer data in a single-burst, read operation.

Example 6.

```

// read status and the three channels of accelerometer and
magnetometer data from
// FXOS8700CQ (13 bytes)
int16_t ReadAccelMagnData(SRAWDATA *pAccelData, SRAWDATA
*pMagnData)
{
    MQX_FILE_PTR fp;                // I2C file pointer
    uint8_t Buffer[FXOS8700CQ_READ_LEN]; // read buffer

    // read FXOS8700CQ_READ_LEN=13 bytes (status byte and the six
channels of data)
    if (s_i2c_read_regs(fp, FXOS8700CQ_SLAVE_ADDR,
FXOS8700CQ_STATUS, Buffer,
        FXOS8700CQ_READ_LEN) == FXOS8700CQ_READ_LEN)
    {
        // copy the 14 bit accelerometer byte data into 16 bit words
        pAccelData->x = (int16_t)(((Buffer[1] << 8) | Buffer[2]))>> 2;
        pAccelData->y = (int16_t)(((Buffer[3] << 8) | Buffer[4]))>> 2;
        pAccelData->z = (int16_t)(((Buffer[5] << 8) | Buffer[6]))>> 2;
        // copy the magnetometer byte data into 16 bit words
        pMagnData->x = (Buffer[7] << 8) | Buffer[8];
        pMagnData->y = (Buffer[9] << 8) | Buffer[10];
    }
}

```

```
        pMagnData->z = (Buffer[11] << 8) | Buffer[12];
    }
    else
    {
        // return with error
        return (I2C_ERROR);
    }

    // normal return
    return (I2C_OK);
}
```

14. Register descriptions

Table 16. Register address map

Address	Name		Access	Default Hex Value	Comment
0x00	STATUS	[1][2][3]	R	0x00	Real-time data-ready status or FIFO status (DR_STATUS or F_STATUS)
0x01	OUT_X_MSB	[1][2][3]	R	Data	[7:0] are 8 MSBs of 14-bit sample. Root pointer to XYZ FIFO data.
0x02	OUT_X_LSB	[1][2][3]	R	Data	[7:2] are 6 LSBs of 14-bit real-time sample
0x03	OUT_Y_MSB	[1][2][3]	R	Data	[7:0] are 8 MSBs of 14-bit real-time sample
0x04	OUT_Y_LSB	[1][2][3]	R	Data	[7:2] are 6 LSBs of 14-bit real-time sample
0x05	OUT_Z_MSB	[1][2][3]	R	Data	[7:0] are 8 MSBs of 14-bit real-time sample
0x06	OUT_Z_LSB	[1][2][3]	R	Data	[7:2] are 6 LSBs of 14-bit real-time sample
0x07 to 0x08	Reserved		R	0x00	Reserved, do not modify contents
0x09	F_SETUP	[1][4]	R/W	0x00	FIFO setup
0x0A	TRIG_CFG		R/W	0x00	FIFO event trigger configuration register
0x0B	SYSMOD	[1][2]	R	0x00	Current system mode
0x0C	INT_SOURCE	[1][2]	R	0x00	Interrupt status
0x0D	WHO_AM_I	[1]	R	0xC7	Device ID
0x0E	XYZ_DATA_CFG	[1][5]	R/W	0x00	Acceleration dynamic range and filter enable settings
0x0F	HP_FILTER_CUTOFF	[1][5]	R/W	0x00	Pulse detection high-pass and low-pass filter enable bits. High-pass filter cutoff frequency selection
0x10	PL_STATUS	[1][2]	R	0x00	Landscape/portrait orientation status
0x11	PL_CFG	[1][5]	R/W	0x80	Landscape/portrait configuration
0x12	PL_COUNT	[1][3][4]	R/W	0x00	Landscape/portrait debounce counter
0x13	PL_BF_ZCOMP	[1][4]	R/W	0x84	Back/front trip angle threshold
0x14	PL_THS_REG	[1][4]	R/W	0x44	Portrait to landscape trip threshold angle and hysteresis settings
0x15	A_FFMT_CFG	[1][5]	R/W	0x00	Freefall/motion function configuration
0x16	A_FFMT_SRC	[1][2]	R	0x00	Freefall/motion event source register
0x17	A_FFMT_THS	[1][3][4]	R/W	0x00	Freefall/motion threshold register
0x18	A_FFMT_COUNT	[1][3][4]	R/W	0x00	Freefall/motion debounce counter
0x19 to 0x1C	Reserved		R/W	-	Reserved, do not modify contents
0x1D	TRANSIENT_CFG	[1][5]	R/W	0x00	FIFO setup
0x1E	TRANSIENT_SRC	[1][2]	R	0x00	Transient event status register
0x1F	TRANSIENT_THS	[1][3][4]	R/W	0x00	Transient event threshold
0x20	TRANSIENT_COUNT	[1][3][4]	R/W	0x00	Transient debounce counter
0x21	PULSE_CFG	[1][5]	R/W	0x00	Pulse function configuration
0x22	PULSE_SRC	[1][2]	R	0x00	Pulse function source register
0x23	PULSE_THSX	[1][3][4]	R/W	0x00	X-axis pulse threshold
0x24	PULSE_THSY	[1][3][4]	R/W	0x00	Y-axis pulse threshold
0x25	PULSE_THSZ	[1][3][4]	R/W	0x00	Z-axis pulse threshold

Table 16. Register address map - *continued*

Address	Name		Access	Default Hex Value	Comment
0x26	PULSE_TMLT	[1][5]	R/W	0x00	Time limit for pulse detection
0x27	PULSE_LTCY	[1][5]	R/W	0x00	Latency time for second pulse detection
0x28	PULSE_WIND	[1][5]	R/W	0x00	Window time for second pulse detection
0x29	ASLP_COUNT	[1][5]	R/W	0x00	In activity counter setting for auto-sleep
0x2A	CTRL_REG1	[1][5]	R/W	0x00	System ODR, accelerometer OSR, operating mode
0x2B	CTRL_REG2	[1][5]	R/W	0x00	Self-test, reset, accelerometer OSR and sleep mode settings
0x2C	CTRL_REG3	[1][5]	R/W	0x00	Sleep mode interrupt wake enable, interrupt polarity, push-pull/open-drain configuration
0x2D	CTRL_REG4	[1][5]	R/W	0x00	Interrupt enable register
0x2E	CTRL_REG5	[1][5]	R/W	0x00	Interrupt pin (INT1/INT2) map
0x2F	OFF_X	[1][5]	R/W	0x00	X-axis accelerometer offset adjust
0x30	OFF_Y	[1][5]	R/W	0x00	Y-axis accelerometer offset adjust
0x31	OFF_Z	[1][5]	R/W	0x00	Z-axis accelerometer offset adjust
0x32	M_DR_STATUS		R	0x00	Magnetic data ready
0x33	M_OUT_X_MSB	[1][3][6]	R	Data	MSB of 16-bit magnetic data for X-axis
0x34	M_OUT_X_LSB	[1][3][6]	R	Data	LSB of 16-bit magnetic data for X-axis
0x35	M_OUT_Y_MSB	[1][3][6]	R	Data	MSB of 16-bit magnetic data for Y-axis
0x36	M_OUT_Y_LSB	[1][3][6]	R	Data	LSB of 16-bit magnetic data for Y-axis
0x37	M_OUT_Z_MSB	[1][3][6]	R	Data	MSB of 16-bit magnetic data for Z-axis
0x38	M_OUT_Z_LSB	[1][3][6]	R	Data	LSB of 16-bit magnetic data for Z-axis
0x39	CMP_X_MSB	[1][5]	R	Data	Bits [13:8] of integrated X-axis acceleration data
0x3A	CMP_X_LSB	[1][5]	R	Data	Bits [7:0] of integrated X-axis acceleration data
0x3B	CMP_Y_MSB	[1][5]	R	Data	Bits [13:8] of integrated Y-axis acceleration data
0x3C	CMP_Y_LSB	[1][5]	R	Data	Bits [7:0] of integrated Y-axis acceleration data
0x3D	CMP_Z_MSB	[1][5]	R	Data	Bits [13:8] of integrated Z-axis acceleration data
0x3E	CMP_Z_LSB	[1][5]	R	Data	Bits [7:0] of integrated Z-axis acceleration data
0x3F	M_OFF_X_MSB	[4][7]	R/W	0x00	MSB of magnetometer of X-axis offset
0x40	M_OFF_X_LSB	[4][7]	R/W	0x00	LSB of magnetometer of X-axis offset
0x41	M_OFF_Y_MSB	[4][7]	R/W	0x00	MSB of magnetometer of Y-axis offset
0x42	M_OFF_Y_LSB	[4][7]	R/W	0x00	LSB of magnetometer of Y-axis offset
0x43	M_OFF_Z_MSB	[4][7]	R/W	0x00	MSB of magnetometer of Z-axis offset
0x44	M_OFF_Z_LSB	[4][7]	R/W	0x00	LSB of magnetometer of Z-axis offset
0x45	MAX_X_MSB	[1][7]	R	Data	Magnetometer X-axis maximum value MSB
0x46	MAX_X_LSB	[1][7]	R	Data	Magnetometer X-axis maximum value LSB
0x47	MAX_Y_MSB	[1][7]	R	Data	Magnetometer Y-axis maximum value MSB
0x48	MAX_Y_LSB	[1][7]	R	Data	Magnetometer Y-axis maximum value LSB
0x49	MAX_Z_MSB	[1][7]	R	Data	Magnetometer Z-axis maximum value MSB
0x4A	MAX_Z_LSB	[1][7]	R	Data	Magnetometer Z-axis maximum value LSB
0x4B	MIN_X_MSB	[1][7]	R	Data	Magnetometer X-axis minimum value MSB

Table 16. Register address map - *continued*

Address	Name		Access	Default Hex Value	Comment
0x4C	MIN_X_LSB	[1][7]	R	Data	Magnetometer X-axis minimum value LSB
0x4D	MIN_Y_MSB	[1][7]	R	Data	Magnetometer Y-axis minimum value MSB
0x4E	MIN_Y_LSB	[1][7]	R	Data	Magnetometer Y-axis minimum value LSB
0x4F	MIN_Z_MSB	[1][7]	R	Data	Magnetometer Z-axis minimum value MSB
0x50	MIN_Z_LSB	[1][7]	R	Data	Magnetometer Z-axis minimum value LSB
0x51	TEMP	[1]	R	Data	Device temperature, valid range of -128 to 127 °C when M_CTRL1[m_hms] > 0b00
0x52	M_THS_CFG	[1][5]	R/W	0x00	Magnetic threshold detection function configuration
0x53	M_THS_SRC	[1][2]	R	Data	Magnetic threshold event source register
0x54	M_THS_X_MSB	[1][5]	R/W	0x00	X-axis magnetic threshold MSB
0x55	M_THS_X_LSB	[1][5]	R/W	0x00	X-axis magnetic threshold LSB
0x56	M_THS_Y_MSB	[1][5]	R/W	0x00	Y-axis magnetic threshold MSB
0x57	M_THS_Y_LSB	[1][5]	R/W	0x00	Y-axis magnetic threshold LSB
0x58	M_THS_Z_MSB	[1][5]	R/W	0x00	Z-axis magnetic threshold MSB
0x59	M_THS_Z_LSB	[1][5]	R/W	0x00	Z-axis magnetic threshold LSB
0x5A	M_THS_COUNT	[1][3][5]	R/W	0x00	Magnetic threshold debounce counter
0x5B	M_CTRL_REG1	[4]	R/W	0x00	Control for magnetic sensor functions
0x5C	M_CTRL_REG2	[5]	R/W	0x00	Control for magnetic sensor functions
0x5D	M_CTRL_REG3	[4]	R/W	0x00	Control for magnetic sensor functions
0x5E	M_INT_SRC		R	0x00	Magnetic interrupt source
0x5F	A_VECM_CFG	[4]	R/W	0x00	Acceleration vector-magnitude configuration register
0x60	A_VECM_THS_MSB	[4]	R/W	0x00	Acceleration vector-magnitude threshold MSB
0x61	A_VECM_THS_LSB	[4]	R/W	0x00	Acceleration vector-magnitude threshold LSB
0x62	A_VECM_CNT	[4]	R/W	0x00	Acceleration vector-magnitude debounce count
0x63	A_VECM_INITX_MSB	[4]	R/W	0x00	Acceleration vector-magnitude X-axis reference value MSB
0x64	A_VECM_INITX_LSB	[4]	R/W	0x00	Acceleration vector-magnitude X-axis reference value LSB
0x65	A_VECM_INITY_MSB	[4]	R/W	0x00	Acceleration vector-magnitude Y-axis reference value MSB
0x66	A_VECM_INITY_LSB	[4]	R/W	0x00	Acceleration vector-magnitude Y-axis reference value LSB
0x67	A_VECM_INITZ_MSB	[4]	R/W	0x00	Acceleration vector-magnitude Z-axis reference value MSB
0x68	A_VECM_INITZ_LSB	[4]	R/W	0x00	Acceleration vector-magnitude Z-axis reference value LSB
0x69	M_VECM_CFG	[4]	R/W	0x00	Magnetic vector-magnitude configuration register
0x6A	M_VECM_THS_MSB	[4]	R/W	0x00	Magnetic vector-magnitude threshold MSB
0x6B	M_VECM_THS_LSB	[4]	R/W	0x00	Magnetic vector-magnitude threshold LSB
0x6C	M_VECM_CNT	[4]	R/W	0x00	Magnetic vector-magnitude debounce count

Table 16. Register address map - ¶continued

Address	Name	Access	Default Hex Value	Comment
0x6D	M_VECM_INITX_MSB [4]	R/W	0x00	Magnetic vector-magnitude reference value X-axis MSB
0x6E	M_VECM_INITX_LSB [4]	R/W	0x00	Magnetic vector-magnitude reference value X-axis LSB
0x6F	M_VECM_INITY_MSB [4]	R/W	0x00	Magnetic vector-magnitude reference value Y-axis MSB
0x70	M_VECM_INITY_LSB [4]	R/W	0x00	Magnetic vector-magnitude reference value Y-axis LSB
0x71	M_VECM_INITZ_MSB [4]	R/W	0x00	Magnetic vector-magnitude reference value Z-axis MSB
0x72	M_VECM_INITZ_LSB [4]	R/W	0x00	Magnetic vector-magnitude reference value Z-axis LSB
0x73	A_FFMT_THS_X_MSB [4]	R/W	0x00	X-axis FMT threshold MSB
0x74	A_FFMT_THS_X_LSB [4]	R/W	0x00	X-axis FFMT threshold LSB
0x75	A_FFMT_THS_Y_MSB [4]	R/W	0x00	Y-axis FFMT threshold MSB
0x76	A_FFMT_THS_Y_LSB [4]	R/W	0x00	Y-axis FFMT threshold LSB
0x77	A_FFMT_THS_Z_MSB [4]	R/W	0x00	Z-axis FFMT threshold MSB
0x78	A_FFMT_THS_Z_LSB [4]	R/W	0x00	Z-axis FFMT threshold LSB
0x79	Reserved	-	-	Reserved, do not modify

- [1] Register contents are preserved when transitioning from active-to-standby mode.
- [2] Register contents are reset when transitioning from standby-to-active mode.
- [3] Hybrid auto-increment mode may be used to read out acceleration and magnetic data from registers x1-x6 using a burst-read transaction. When M_CTRL_REG2[hyb_autoinc_mode] = 1, the user may do a burst read of 12 bytes starting from OUT_X_MSB (address 0x1) to read out both the current accelerometer and magnetometer data in one contiguous operation.
- [4] Register contents can be modified anytime in standby or active mode. A write to this register will cause a reset of the corresponding internal system debounce counter.
- [5] Modification of this register's contents can only occur when device is in standby mode, except the FS[1:0] bit fields in XYZ_DATA_CFG register.
- [6] To ensure that valid data is read from these registers, the user must first read the M_OUT_X_MSB register in either burst- or single-read mode. Reading of the M_OUT_X_MSB register triggers the update of the M_OUT_X/Y/Z registers with the current time-aligned output data.
- [7] To ensure that valid data is read from these registers, the user must first read the MSB register of each register pair in either burst- or single-read mode. Reading of the LSB register without first reading the MSB register will result in invalid data.

Table 17. Auto-increment address

Address	Name	Auto-increment address			
		STATUS[<i>f_mode</i>] = 00, CTRL_REG1[<i>f_read</i>] = 0	STATUS[<i>f_mode</i>] > 00, CTRL_REG1[<i>f_read</i>] = 0	STATUS[<i>f_mode</i>] = 00, CTRL_REG1[<i>f_read</i>] = 1	STATUS[<i>f_mode</i>] > 00, CTRL_REG1[<i>f_read</i>] = 1
0x00	STATUS	0x01			
0x01	OUT_X_MSB	0x02	0x01	0x03	0x01
0x02	OUT_X_LSB	0x03		0x00	
0x03	OUT_Y_MSB	0x04		0x05	0x00
0x04	OUT_Y_LSB	0x05		0x00	
0x05	OUT_Z_MSB	0x06		M_CTRL_REG2[hyb_autoinc_mode] = 0 → 0x00, M_CTRL_REG2[hyb_autoinc_mode] = 1 → 0x33	
0x06	OUT_Z_LSB	M_CTRL_REG2[hyb_autoinc_mode] = 0 → 0x00, M_CTRL_REG2[hyb_autoinc_mode] = 1 → 0x33			
0x07 to 0x08	Reserved	-			
0x09	F_SETUP	0x0A			
0x0A	TRIG_CFG	0x0B			
0x0B	SYSMOD	0x0C			
0x0C	INT_SOURCE	0x0D			
0x0D	WHO_AM_I	0x0E			
0x0E	XYZ_DATA_CFG	0x0F			
0x0F	HP_FILTER_CUTOFF	0x10			
0x10	PL_STATUS	0x11			
0x11	PL_CFG	0x12			
0x12	PL_COUNT	0x13			
0x13	PL_BF_ZCOMP	0x14			
0x14	PL_THS_REG	0x15			
0x15	A_FFMT_CFG	0x16			
0x16	A_FFMT_SRC	0x17			
0x17	A_FFMT_THS	0x18			
0x18	A_FFMT_COUNT	0x19			
0x19 to 0x1C	Reserved	-			
0x1D	TRANSIENT_CFG	0x1E			
0x1E	TRANSIENT_SRC	0x1F			
0x1F	TRANSIENT_THS	0x20			
0x20	TRANSIENT_COUNT	0x21			
0x21	PULSE_CFG	0x22			
0x22	PULSE_SRC	0x23			
0x23	PULSE_THSX	0x24			

Table 17. Auto-increment address - *f*_{continued}

Address	Name	Auto-increment address			
		STATUS[f_mode] = 00, CTRL_REG1[f_read] = 0	STATUS[f_mode] > 00, CTRL_REG1[f_read] = 0	STATUS[f_mode] = 00, CTRL_REG1[f_read] = 1	STATUS[f_mode] > 00, CTRL_REG1[f_read] = 1
0x24	PULSE_THSY			0x25	
0x25	PULSE_THSZ			0x26	
0x26	PULSE_TMLT			0x27	
0x27	PULSE_LTCY			0x28	
0x28	PULSE_WIND			0x29	
0x29	ASLP_COUNT			0x2A	
0x2A	CTRL_REG1			0x2B	
0x2B	CTRL_REG2			0x2C	
0x2C	CTRL_REG3			0x2D	
0x2D	CTRL_REG4			0x2E	
0x2E	CTRL_REG5			0x2F	
0x2F	OFF_X			0x30	
0x30	OFF_Y			0x31	
0x31	OFF_Z			0x32	
0x32	M_DR_STATUS			0x33	
0x33	M_OUT_X_MSB			0x34	
0x34	M_OUT_X_LSB			0x35	
0x35	M_OUT_Y_MSB			0x36	
0x36	M_OUT_Y_LSB			0x37	
0x37	M_OUT_Z_MSB			0x38	
0x38	M_OUT_Z_LSB			0x39	
0x39	CMP_X_MSB			0x3A	
0x3A	CMP_X_LSB			0x3B	
0x3B	CMP_Y_MSB			0x3C	
0x3C	CMP_Y_LSB			0x3D	
0x3D	CMP_Z_MSB			0x3E	
0x3E	CMP_Z_LSB			0x3F	
0x3F	M_OFF_X_MSB			0x40	
0x40	M_OFF_X_LSB			0x41	
0x41	M_OFF_Y_MSB			0x42	
0x42	M_OFF_Y_LSB			0x43	
0x43	M_OFF_Z_MSB			0x44	
0x44	M_OFF_Z_LSB			0x45	
0x45	MAX_X_MSB			0x46	

Table 17. Auto-increment address - *continued*

Address	Name	Auto-increment address			
		STATUS[f_mode] = 00, CTRL_REG1[f_read] = 0	STATUS[f_mode] > 00, CTRL_REG1[f_read] = 0	STATUS[f_mode] = 00, CTRL_REG1[f_read] = 1	STATUS[f_mode] > 00, CTRL_REG1[f_read] = 1
0x46	MAX_X_LSB			0x47	
0x47	MAX_Y_MSB			0x48	
0x48	MAX_Y_LSB			0x49	
0x49	MAX_Z_MSB			0x4A	
0x4A	MAX_Z_LSB			0x4B	
0x4B	MIN_X_MSB			0x4C	
0x4C	MIN_X_LSB			0x4D	
0x4D	MIN_Y_MSB			0x4E	
0x4E	MIN_Y_LSB			0x4F	
0x4F	MIN_Z_MSB			0x50	
0x50	MIN_Z_LSB			0x51	
0x51	TEMP			0x52	
0x52	M_THS_CFG			0x53	
0x53	M_THS_SRC			0x54	
0x54	M_THS_X_MSB			0x55	
0x55	M_THS_X_LSB			0x56	
0x56	M_THS_Y_MSB			0x57	
0x57	M_THS_Y_LSB			0x58	
0x58	M_THS_Z_MSB			0x59	
0x59	M_THS_Z_LSB			0x5A	
0x5A	M_THS_COUNT			0x5B	
0x5B	M_CTRL_REG1			0x5C	
0x5C	M_CTRL_REG2			0x5D	
0x5D	M_CTRL_REG3			0x5E	
0x5E	M_INT_SRC			0x5F	
0x5F	A_VECM_CFG			0x60	
0x60	A_VECM_THS_MSB			0x61	
0x61	A_VECM_THS_LSB			0x62	
0x62	A_VECM_CNT			0x63	
0x63	A_VECM_INITX_MSB			0x64	
0x64	A_VECM_INITX_LSB			0x65	
0x65	A_VECM_INITY_MSB			0x66	
0x66	A_VECM_INITY_LSB			0x67	
0x67	A_VECM_INITZ_MSB			0x68	

Table 17. Auto-increment address - *continued*

Address	Name	Auto-increment address			
		STATUS[f_mode] = 00, CTRL_REG1[f_read] = 0	STATUS[f_mode] > 00, CTRL_REG1[f_read] = 0	STATUS[f_mode] = 00, CTRL_REG1[f_read] = 1	STATUS[f_mode] > 00, CTRL_REG1[f_read] = 1
0x68	A_VECM_INITZ_LSB			0x69	
0x69	M_VECM_CFG			0x6A	
0x6A	M_VECM_THS_MSB			0x6B	
0x6B	M_VECM_THS_LSB			0x6C	
0x6C	M_VECM_CNT			0x6D	
0x6D	M_VECM_INITX_MSB			0x6E	
0x6E	M_VECM_INITX_LSB			0x6F	
0x6F	M_VECM_INITY_MSB			0x70	
0x70	M_VECM_INITY_LSB			0x71	
0x71	M_VECM_INITZ_MSB			0x72	
0x72	M_VECM_INITZ_LSB			0x73	
0x73	A_FFMT_THS_X_MSB			0x74	
0x74	A_FFMT_THS_X_LSB			0x75	
0x75	A_FFMT_THS_Y_MSB			0x76	
0x76	A_FFMT_THS_Y_LSB			0x77	
0x77	A_FFMT_THS_Z_MSB			0x78	
0x78	A_FFMT_THS_Z_LSB			0x79	
0x79	Reserved			-	

NOTE

The auto-increment addressing is only enabled when registers are read using burst-read mode when configured for either I²C or SPI. The auto-increment address is automatically reset to 0x00 in I²C mode when a stop condition is detected. In SPI mode there is no stop condition and the auto-increment address is not automatically reset to 0x00.

14.1 Device configuration registers

14.1.1 STATUS register (address 0x00)

Table 18. STATUS register (address 0x00) bit allocation

Bit	7	6	5	4	3	2	1	0
Symbol	DR_STATUS or F_STATUS							
Reset	0	0	0	0	0	0	0	0
Access	R	R	R	R	R	R	R	R

Table 19. STATUS register (address 0x00) bit description

Field	Description
F_SETUP[f_mode] = 0b00	register 0x00 → DR_STATUS
F_SETUP[f_mode] > 0b00	register 0x00 → F_STATUS

The STATUS register aliases allow for the contiguous burst read of both status and current acceleration sample/FIFO data using the auto-increment addressing mechanism in both 8- and 14-bit modes.

14.1.2 DR_STATUS register (address 0x00)

Data-ready status when F_SETUP[f_mode] = 0x00

This STATUS register provides the acquisition status information on a per-sample basis, and reflects real-time updates to the OUT_X, OUT_Y, and OUT_Z registers.

When the FIFO subsystem data output register driver is disabled (F_SETUP[f_mode] = 0b00), this register indicates the real-time status information of the accelerometer X, Y, and Z axes sample data.

Table 20. DR_STATUS register (address 0x00) bit allocation

Bit	7	6	5	4	3	2	1	0
Symbol	zyxow	zow	yow	xow	zyxdr	zdr	ydr	xdr
Reset	0	0	0	0	0	0	0	0
Access	R	R	R	R	R	R	R	R

Table 21. DR_STATUS register (address 0x00) bit descriptions

Field	Description
zyxow	<p>zyxow is set to 1 whenever new data is acquired before completing the retrieval of the previous set. This event occurs when the content of at least one acceleration data register (that is, OUT_X, OUT_Y, and OUT_Z) has been overwritten. zyxow is cleared when the high-bytes of the acceleration data (OUT_X_MSB, OUT_Y_MSB, and OUT_Z_MSB) are read.</p> <p>X, Y, and Z-axis data overwrite.</p> <p>0 – No data overwrite has occurred 1 – Previous X, Y, and Z data was overwritten by new X, Y, and Z data before it was completely read</p>
zow	<p>zow is set to 1 whenever a new Z-axis acquisition is completed before the retrieval of the previous data. When this occurs the previous data is overwritten. zow is cleared anytime OUT_Z_MSB register is read.</p> <p>Z-axis data overwrite.</p> <p>0 – No data overwrite has occurred 1 – Previous Z-axis data was overwritten by new Z-axis data before it was read</p>
yow	<p>yow is set to 1 whenever a new Y-axis acquisition is completed before the retrieval of the previous data. When this occurs the previous data is overwritten. yow is cleared anytime OUT_Y_MSB register is read.</p> <p>Y-axis data overwrite.</p> <p>0 – No data overwrite has occurred 1 – Previous Y-axis data was overwritten by new Y-axis data before it was read</p>
xow	<p>xow is set to 1 whenever a new X-axis acquisition is completed before the retrieval of the previous data. When this occurs the previous data is overwritten. xow is cleared anytime OUT_X_MSB register is read.</p> <p>X-axis data overwrite.</p> <p>0 – No data overwrite has occurred 1 – Previous X-axis data was overwritten by new X-axis data before it was read</p>
zyxdr	<p>zyxdr signals that a new acquisition for any of the enabled channels is available. zyxdr is cleared when the high-bytes of the acceleration data (OUT_X_MSB, OUT_Y_MSB, OUT_Z_MSB) are read.</p> <p>X, Y, and Z-axis new data ready.</p> <p>0 – No new set of data ready 1 – New set of data is ready</p>
zdr	<p>zdr is set to 1 whenever a new Z-axis data acquisition is completed. zdr is cleared anytime the OUT_Z_MSB register is read.</p> <p>Z-axis new data available.</p> <p>0 – No new Z-axis data is ready 1 – New Z-axis data is ready</p>
ydr	<p>ydr is set to 1 whenever a new Y-axis data acquisition is completed. ydr is cleared anytime the OUT_Y_MSB register is read.</p> <p>Y-axis new data available. Default value: 0</p> <p>0 – No new Y-axis data ready 1 – New Y-axis data is ready</p>
xdr	<p>xdr is set to 1 whenever a new X-axis data acquisition is completed. xdr is cleared anytime the OUT_X_MSB register is read.</p> <p>X-axis new data available. Default value: 0</p> <p>0 – No new X-axis data ready 1 – New X-axis data is ready</p>

14.1.3 F_STATUS register (address 0x00)

FIFO Status when F_SETUP[f_mode] = 0x00 > 0x00.

If the FIFO subsystem data output register driver is enabled, the status register indicates the current status information of the FIFO subsystem.

Table 22. F_STATUS register (address 0x00) bit allocation

Bit	7	6	5	4	3	2	1	0
Symbol	f_ovf	f_wmrk_flag				f_cnt[5:0]		
Reset	0	0	0	0	0	0	0	0
Access	R	R	R	R	R	R	R	R

Table 23. FIFO flag event descriptions

f_ovf	f_wmrk_flag	Event description
0	X	No FIFO overflow events detected.
1	X	FIFO overflow event detected.
X	0	No FIFO watermark event detected.
X	1	A FIFO watermark event was detected indicating that a FIFO sample count greater than watermark value has been reached. If F_SETUP[f_mode] = 0b11, a FIFO trigger event was detected

The f_ovf and f_wmrk_flag flags remain asserted while the event source is still active, but the user can clear the FIFO interrupt bit in the interrupt source register (INT_SOURCE) by reading the F_STATUS register. In this case, the INT_SOURCE[src_fifo] bit will be set again when the next data sample enters the FIFO.

Therefore, the f_ovf bit will remain asserted while the FIFO has overflowed and the f_wmrk_flag bit will remain asserted while the f_cnt value is equal to or greater than then f_wmrk value.

Table 24. FIFO - sample count (address 0x00) bit description

Field	Description
f_cnt[5:0]	These bits indicate the number of acceleration samples currently stored in the FIFO buffer. Count 0b00_0000 indicates that the FIFO is empty. FIFO sample counter. Default value 0b00_0000. (0b00_0001 to 0b10_0000 indicates 1 to 32 samples stored in FIFO

14.1.4 TRIG_CFG register (address 0x0A)

FIFO trigger configuration register. After the interrupt flag of the enabled event in TRIG_CFG is set, the FIFO (when configured in Trigger mode) is gated at the time of the interrupt event preventing the further collection of data samples. This allows the host processor to analyze the data leading up to the event detection (up to 32 samples). For detailed information on how to utilize the FIFO and the various trigger events, please see NXP application note AN4073.

Table 25. TRIG_CFG register (address 0x0A) bit allocation

Bit	7	6	5	4	3	2	1	0
Symbol	-	-	trig_trans	trig_Indprt	trig_pulse	trig_ffmt	trig_a_vecm	-
Reset	0	0	0	0	0	0	0	0
Access	R/W	R/W	R/W	R/W	R/W	R/W	R/W	R/W

Table 26. TRIG_CFG register (address 0x0A) bit descriptions

Field	Description
trig_trans	Transient interrupt FIFO trigger enable.
trig_Indprt	Landscape/portrait orientation interrupt FIFO trigger enable.
trig_pulse	Pulse interrupt FIFO trigger enable
trig_ffmt	Freefall/motion interrupt FIFO trigger enable
trig_a_vecm	Acceleration vector-magnitude FIFO trigger enable.

14.1.5 SYSMOD register (address 0x0B)

Table 27. SYSMOD register (address 0x0B) bit allocation

Bit	7	6	5	4	3	2	1	0
Symbol	fgerr	fgt[4:0]			sysmod[1:0]			
Reset	0	0	0	0	0	0	0	0
Access	R	R	R	R	R	R	R	R

Table 28. SYSMOD register (address 0x0B) bit descriptions

Field	Description
fgerr	FIFO gate error. Default value: 0. 0 – No FIFO gate error detected. 1 – FIFO gate error was detected. Emptying the FIFO buffer clears the fgerr bit in the SYSMOD register. See Section 14.1.10 for more information on configuring the FIFO gate function.
fgt[4:0]	Number of ODR time units since fgerr was asserted. Reset when fgerr is cleared
sysmod[1:0]	System mode. Default value: 0b00. 0b00 – Standby mode 0b01 – Wake mode 0b10 – Sleep mode

The system mode register indicates the current device operating mode. Applications using the auto-sleep/auto-wake mechanism should use this register to synchronize their application with the device operating mode. The system mode register also indicates the status of the FIFO gate error flag and the time elapsed since the FIFO gate error flag was asserted.

14.1.6 INT_SOURCE register (address 0x0C)

Interrupt source register. The bits that are set (logic '1') indicate which function has asserted its interrupt and conversely bits that are cleared (logic '0') indicate which function has not asserted its interrupt. Additional interrupt flags for magnetic interrupt events are located in the M_INT_SRC register (0x5E).

Reading the INT_SOURCE register does not clear any interrupt status bits (except for src_a_vecm, see [Table 29](#)); the respective interrupt flag bits are reset by reading the appropriate source register for the function that generated the interrupt.

Table 29. INT_SOURCE register (address 0x0C) bit allocation

Bit	7	6	5	4	3	2	1	0
Symbol	src_aslp	src_fifo	src_trans	src_Indprt	src_pulse	src_ffmt	src_a_vecm	src_drdy
Reset	0	0	0	0	0	0	0	0
Access	R	R	R	R	R	R	R	R

Table 30. INT_SOURCE register (address 0x0C) bit descriptions

Field	Description
src_aslp	<p>Auto-sleep/wake interrupt status bit: logic '1' indicates that an interrupt event that can cause a wake-to-sleep or sleep-to-wake system mode transition has occurred and logic '0' indicates that no wake-to-sleep or sleep-to-wake system mode transition interrupt event has occurred.</p> <p>The "wake-to-sleep" transition occurs when a period of inactivity that exceeds the user-specified time limit (ASLP_COUNT) has been detected, thus causing the system to transition to a user-specified low ODR setting.</p> <p>A "sleep-to-wake" transition occurs when the user-specified interrupt event has awakened the system, thus causing the system to transition to the user-specified higher ODR setting.</p> <p>Reading the SYSMOD register will clear the src_aslp bit.</p>
src_fifo	<p>FIFO interrupt status bit: logic '1' indicates that a FIFO interrupt event such as an overflow or watermark (F_STATUS[f_cnt] = F_STATUS[f_wmrk]) event has occurred and logic '0' indicates that no FIFO interrupt event has occurred.</p> <p>This bit is cleared by reading the F_STATUS register.</p>
src_trans	<p>Transient interrupt status bit: logic '1' indicates that an acceleration transient value greater than user-specified threshold has occurred. and logic '0' indicates that no transient event has occurred.</p> <p>This bit is asserted whenever TRANSIENT_SRC[ea] is asserted and the functional block interrupt has been enabled.</p> <p>This bit is cleared by reading the TRANSIENT_SRC register.</p>
src_Indprt	<p>Landscape/portrait orientation interrupt status bit: logic '1' indicates that an interrupt was generated due to a change in the device orientation status and logic '0' indicates that no change in orientation status was detected.</p> <p>This bit is asserted whenever PL_STATUS[newlp] is asserted and the functional block interrupt has been enabled.</p> <p>This bit is cleared by reading the PL_STATUS register.</p>
src_pulse	<p>Pulse interrupt status bit: logic '1' indicates that an interrupt was generated due to single- and/or double-pulse event and logic '0' indicates that no pulse event was detected.</p> <p>This bit is asserted whenever PULSE_SRC[ea] is asserted and the functional block interrupt has been enabled.</p> <p>This bit is cleared by reading the PULSE_SRC register.</p>

Table 30. INT_SOURCE register (address 0x0C) bit descriptions - *continued*

Field	Description
src_ffmt	Freefall/motion interrupt status bit: logic '1' indicates that the freefall/motion function interrupt is active and logic '0' indicates that no freefall or motion event was detected. This bit is asserted whenever A_FFMT_SRC[ea] is asserted and the functional block interrupt has been enabled. This bit is cleared by reading the A_FFMT_SRC register.
src_a_vecm	Accelerometer vector-magnitude interrupt status bit: logic '1' indicates that an interrupt was generated due to acceleration vector-magnitude function and logic '0' indicates that no interrupt has been generated. This bit is cleared by reading this register (INT_SOURCE).
src_drdy	Data-ready interrupt status bit. In acceleration only mode this bit indicates that new accelerometer data is available to read. In magnetometer only mode, src_drdy indicates that new magnetic data is available to be read. In hybrid mode, this bit signals that new acceleration and/or magnetic data is available. The src_drdy interrupt flag is cleared by reading out the acceleration data in accelerometer only mode and by reading out the magnetic data in magnetometer only or hybrid modes. In hybrid mode and with M_CTRL_REG2[hyb_autoinc_mode] = 1, all of the sensor data can be read out in a 12-byte burst read starting at register 0x01 (OUT_X_MSB).

14.1.7 WHO_AM_I register (address 0x0D)

Device identification register. This register contains the device identifier which is set to 0xC4 for preproduction devices and 0xC7 for production devices.

Table 31. WHO_AM_I register (address 0x0D) bit allocation

Bit	7	6	5	4	3	2	1	0
Symbol	who_am_i[7:0]							
Reset	1	1	0	0	0	1	1	1
Access	R	R	R	R	R	R	R	R

14.1.8 CTRL_REG1 register (address 0x0A)

NOTE

Except for standby mode selection, the device must be in standby mode to change any of the fields within CTRL_REG1 (0x2A).

Table 32. CTRL_REG1 register (address 0x0A) bit allocation

Bit	7	6	5	4	3	2	1	0
Symbol	aslp_rate[1:0]		dr[2:0]			Inoise	f_read	active
Reset	0	0	0	0	0	0	0	0
Access	R/W	R/W	R/W	R/W	R/W	R/W	R/W	R/W

Table 33. CTRL_REG1 register (address 0x0A) bit descriptions

Field	Description
aslp_rate[1:0]	Configures the auto-wake sample frequency when the device is in sleep mode. See Table 35 for more information.
dr[2:0]	Output data rate (ODR) selection. See Table 35 for more information.
Inoise	Reduced noise and full-scale range mode (analog gain times 2). 0 – Normal mode 1 – Reduced noise mode; Note that the FSR setting is restricted to $\pm 2 g$ or $\pm 4 g$ mode. This feature cannot be used in $\pm 8 g$ mode.
f_read	Fast-read mode: Data format is limited to the 8-bit MSB for accelerometer output data. The auto-address pointer will skip over the LSB addresses for each axes sample data when performing a burst-read operation. 0 – Normal mode 1 – Fast-read mode
active	Standby/active. 0 – Standby mode 1 – Active mode

Table 34. Sleep mode ODR selection

aslp_rate[1]	aslp_rate[0]	Frequency (Hz)
0	0	50
0	1	12.5
1	0	6.25
1	1	1.56

It is important to note that when the device is in auto-sleep mode, the system ODR and data rate for all the system functional blocks is overridden by the sleep data rate set by the aslp_rate field. When hybrid mode is enabled, the frequency is one-half of what is shown in [Table 35](#). For example, with aslp_rate = 0b00 the frequency is 25 Hz.

[Table 35](#) shows the various system output data rates (ODR) that may be selected using the dr[2:0] bits. The selected ODR is reduced by a factor of two when the device is operated in hybrid mode.

Table 35. System Output Data Rate selection

dr[2]	dr[2]	dr[2]	ODR accelerometer or magnetometer only modes (Hz)	Period accelerometer or magnetometer only modes (ms)	ODR hybrid mode (Hz)	Period hybrid mode (ms)
0	0	0	800.0	1.25	400	2.5
0	0	1	400.0	2.5	200	5
0	1	0	200.0	5	100	10
0	1	1	100.0	10	50	20
1	0	0	50.0	20	25	80
1	0	1	12.5	80	6.25	160
1	1	0	6.25	160	3.125	320
1	1	1	1.5625	640	0.7813	1280

The active bit selects between standby mode and active mode. The default value is 0 (standby mode) on reset.

The Inoise bit selects between normal full dynamic range mode and a high sensitivity, low-noise mode. In low-noise mode the maximum signal that can be measured is $\pm 4 g$. Note: Any thresholds set above 4 g will not be reached.

The f_read bit selects between normal and fast-read modes where the auto-increment counter will also skip over the LSB data bytes when f_read = 1. In hybrid mode and with M_CTRL_REG2[hyb_autoinc_mode] = 1, all of the sensor data MSB's can be read out with a single 6-byte burst read starting at the OUT_X_MSB register.

NOTE

The f_read bit can only be changed while F_SETUP[f_mode] = 0.

14.1.9 CTRL_REG2 register (address 0x2B)

Table 36. CTRL_REG2 register (address 0x2B) bit allocation

Bit	7	6	5	4	3	2	1	0
Symbol	st	rst	-	smods[1:0]		slpe	mods[1:0]	
Reset	0	0	0	0	0	0	0	0
Access	R/W	R/W	R/W	R/W	R/W	R/W	R/W	R/W

Table 37. CTRL_REG2 register (address 0x2B) bit descriptions

Field	Description
st	<p>The st bit activates the accelerometer self-test function. When st is set to 1, a change will occur in the device output levels for each axis, allowing the host application to check the functionality of the transducer and measurement signal chain.</p> <p>Self-test enable:</p> <p>0 – Self-test disabled</p> <p>1 – Self-test enabled</p>
rst	<p>The rst bit is used to initiate a software reset. The reset mechanism can be enabled in both standby and active modes. When the rst bit is set, the boot mechanism resets all functional block registers and loads the respective internal registers with their default values. Refer to document FXOS8700CQER for further information and a suggested work-around. After setting the rst bit, the system will automatically transition to standby mode. Therefore, if the system was already in standby mode, the reboot process will immediately begin; else if the system was in active mode the boot mechanism will automatically transition the system from active mode to standby mode, only then can the reboot process begin. A system reset can also be initiated by pulsing the external RST pin high.</p> <p>The host application should allow 1 ms between issuing a software (setting rst bit) or hardware (pulsing RST pin) reset and attempting communications with the device over the I²C or SPI interfaces. When the SPI interface mode is desired and multiple devices are present on the bus, make sure that the bus is quiet (all slave device MISO pins are high-z) during this 1 ms period to ensure the device does not inadvertently enter I²C mode. See Section 10.2.3 for further information about the interface mode auto-detection circuit.</p> <p>Note: The I²C and SPI communication systems are also reset to avoid corrupted data transactions. On issuing a software reset command over an I²C interface, the device immediately resets and does not send any acknowledgment (ACK) of the written byte to the master. The host application has to implement the I²C driver in such a way that it does not look for an ACK following a soft reset command.</p> <p>At the end of the boot process, the rst bit is hardware cleared.</p> <p>0 – Device reset disabled</p> <p>1 – Device reset enabled</p>
smods[1:0]	<p>Accelerometer sleep mode OSR mode selection. This setting, along with the CTRL_REG1[aslp_rate] ODR setting determines the sleep mode power and noise for acceleration measurements.</p> <p>See Table 38 and Table 39 for more information.</p>
slpe ^[1]	<p>Auto-sleep mode enable:</p> <p>0 – Auto-sleep is not enabled</p> <p>1 – Auto-sleep is enabled</p>
mods[1:0]	<p>Accelerometer wake mode OSR mode selection. This setting, along with the ODR selection (CTRL_REG1[dr]) determines the wake mode power and noise for acceleration measurements. See Table 38 and Table 39 for more information.</p>

[1] When slpe = 1, a transition between sleep mode and wake mode (or vice-versa) results in a FIFO flush and resets all of the internal functions debounce counters. All functional block status information is preserved except where otherwise indicated. For further information, refer to the CTRL_REG3 register description (fifo_gate bit).

Table 38. CTRL_REG2[(s)mods] oversampling modes

(s)mods[1]	(s)mods[0]	Power mode
0	0	Normal
0	1	Low noise, low power
1	0	High resolution
1	1	Low power

Table 39. Oversampling Ratio versus oversampling mode

Accelerometer OSR				
ODR (Hz)	Normal	Low noise, low power	High resolution	Low power
1.5625	128	32	1024	16
6.25	32	8	256	4
12.5	16	4	128	2
50	4	4	32	2
100	4	4	16	2
200	4	4	8	2
400	4	4	4	2
800	2	2	2	2

14.1.10 CTRL_REG3 - interrupt control register (address 0x2C)

Table 40. CTRL_REG3 - interrupt control register (address 0x2C) bit allocation

Bit	7	6	5	4	3	2	1	0
Symbol	fifo_gate	wake_trans	wake_Indprt	wake_pulse	wake_ffmt	wake_a_vecm	ipol	pp_od
Reset	0	0	0	0	0	0	0	0
Access	R/W	R/W	R/W	R/W	R/W	R/W	R/W	R/W

Table 41. CTRL_REG3 - interrupt control register (address 0x2C) bit descriptions

Field	Description
fifo_gate	<p>0 – FIFO gate is bypassed. FIFO is flushed upon the system mode transitioning from wake-to-sleep mode or from sleep-to-wake mode.</p> <p>1 – The FIFO input buffer is blocked from accepting new samples when transitioning from “wake-to-sleep” mode or from “sleep-to-wake” mode until the FIFO is flushed [1]. Although the system transitions from “wake-to-sleep” or from “sleep-to-wake” the contents of the FIFO buffer are preserved and new data samples are ignored until the FIFO is emptied by the host application.</p> <p>If the fifo_gate bit is set to logic ‘1’ and the FIFO buffer is not emptied before the arrival of the next sample, then the SYSMOD[fgerr] will be asserted. The SYSMOD[fgerr] bit remains asserted as long as the FIFO buffer remains un-emptied.</p> <p>Emptying the FIFO buffer clears the SYS_MOD[fgerr] register.</p>
wake_tran	<p>0 – Transient function is disabled in sleep mode</p> <p>1 – Transient function is enabled in sleep mode and can generate an interrupt to wake the system</p>
wake_Indprt	<p>0 – Orientation function is disabled sleep mode.</p> <p>1 – Orientation function is enabled in sleep mode and can generate an interrupt to wake the system</p>
wake_pulse	<p>0 – Pulse function is disabled in sleep mode</p> <p>1 – Pulse function is enabled in sleep mode and can generate an interrupt to wake the system</p>
wake_ffmt	<p>0 – Freefall/motion function is disabled in sleep mode</p> <p>1 – Freefall/motion function is enabled in sleep mode and can generate an interrupt to wake the system</p>

Table 41. CTRL_REG3 - interrupt control register (address 0x2C) bit descriptions - ¶continued

Field	Description
wake_a_vecm	<p>0 – Acceleration vector-magnitude function is disabled in sleep mode</p> <p>1 – Acceleration vector-magnitude function is enabled in sleep mode and can generate an interrupt to wake the system</p>
ipol	<p>The ipol The bit selects the logic polarity of the interrupt signals output on the INT1 and INT2 pins. INT1/INT2 interrupt logic polarity:</p> <p>0 – Active low (default)</p> <p>1 – Active high</p>
pp_od	<p>INT1/INT2 push-pull or open-drain output mode selection. The open-drain configuration can be used for connecting multiple interrupt signals on the same interrupt line but will require an external pullup resistor to function correctly.</p> <p>0 – Push-pull (default)</p> <p>1 – Open drain</p>

[1] The FIFO contents are flushed whenever the system ODR changes in order to prevent the mixing of FIFO data from different ODR periods.

The wake enable bits for the magnetic threshold and magnetic vector-magnitude functions are located in registers 0x52 (MAG_THS_CFG) and 0x69 (M_VECM_CFG), respectively.

14.1.11 CTRL_REG4 - interrupt enable register (address 0x2D)

Table 42. CTRL_REG4 - interrupt enable register (address 0x2D) bit allocation

Bit	7	6	5	4	3	2	1	0
Symbol	int_en_aslp	int_en_fifo	int_en_trans	int_en_Indprt	int_en_pulse	int_en_ffmt	int_en_a_vecm	int_en_drdy
Reset	0	0	0	0	0	0	0	0
Access	R/W	R/W	R/W	R/W	R/W	R/W	R/W	R/W

Table 43. CTRL_REG4 - interrupt enable register (address 0x2D) bit descriptions

Field	Description
int_en_aslp	<p>Sleep interrupt enable</p> <p>0 – Auto-sleep/wake interrupt disabled</p> <p>1'b1 – Auto-sleep/wake interrupt enabled</p>
int_en_fifo	<p>FIFO interrupt enable</p> <p>0 – FIFO interrupt disabled</p> <p>1 – FIFO interrupt enabled</p>
int_en_trans	<p>Transient interrupt enable</p> <p>0 – Transient interrupt disabled</p> <p>1 – Transient interrupt enabled</p>
int_en_Indprt	<p>Orientation interrupt enable</p> <p>0 – Orientation (landscape/portrait) interrupt disabled</p> <p>1 – Orientation (landscape/portrait) interrupt enabled</p>
int_en_pulse	<p>Pulse interrupt enable</p> <p>0 – Pulse detection interrupt disabled</p> <p>1 – Pulse detection interrupt enabled</p>

Table 43. CTRL_REG4 - interrupt enable register (address 0x2D) bit descriptions - *continued*

Field	Description
int_en_ffmt	Freefall/motion interrupt enable 0 – Freefall/motion interrupt disabled 1 – Freefall/motion interrupt enabled
int_en_a_vecm	Acceleration vector-magnitude interrupt enable 0 – Acceleration vector-magnitude interrupt disabled 1 – Acceleration vector-magnitude interrupt enabled
int_en_drdy	Data-ready interrupt enable 0 – Data-ready interrupt disabled 1 – Data-ready interrupt enabled

The corresponding functional block interrupt enable bit allows the functional block to route its event detection flag to the system’s interrupt controller. The interrupt controller routes the enabled interrupt signals to either the INT1 or INT2 pins depending on the settings made in CTRL_REG5. Please note that the interrupt enable bits for the magnetic threshold and vector-magnitude interrupts are located in registers 0x52 (MAG_THS_CFG), and 0x69 (M_VECM_CFG), respectively.

14.1.12 CTRL_REG5 - interrupt routing configuration register (address 0x2E)

Table 44. CTRL_REG5 - interrupt routing configuration register (address 0x2E) bit allocation

Bit	7	6	5	4	3	2	1	0
Symbol	int_cfg_aslp	int_cfg_fifo	int_cfg_trans	int_cfg_Indprt	int_cfg_pulse	int_cfg_ffmt	int_cfg_a_vecm	int_cfg_drdy
Reset	0	0	0	0	0	0	0	0
Access	R/W	R/W	R/W	R/W	R/W	R/W	R/W	R/W

Table 45. CTRL_REG5 - interrupt routing configuration register (address 0x2E) bit descriptions

Field	Description
int_cfg_aslp	Sleep interrupt routing 0 – Interrupt is routed to INT2 pin 1 – Interrupt is routed to INT1 pin
int_cfg_fifo	FIFO interrupt routing 0 – Interrupt is routed to INT2 pin 1 – Interrupt is routed to INT1 pin
int_cfg_trans	Transient detection interrupt routing 0 – Interrupt is routed to INT2 pin 1 – Interrupt is routed to INT1 pin
int_cfg_Indprt	Orientation detection interrupt routing 0 – Interrupt is routed to INT2 pin 1 – Interrupt is routed to INT1 pin
int_cfg_pulse	Pulse detection interrupt routing 0 – Interrupt is routed to INT2 pin 1 – Interrupt is routed to INT1 pin

Table 45. CTRL_REG5 - interrupt routing configuration register (address 0x2E) bit descriptions - ¶continued

Field	Description
int_cfg_ffmt	Freefall/motion detection interrupt routing 0 – Interrupt is routed to INT2 pin 1 – Interrupt is routed to INT1 pin
int_cfg_a_vecm	Acceleration vector-magnitude interrupt routing 0 – Interrupt is routed to INT2 pin 1 – Interrupt is routed to INT1 pin.
int_cfg_drdy	Data-ready interrupt routing 0 – Interrupt is routed to INT2 pin 1 – Interrupt is routed to INT1 pin

Please note that the routing configuration for the magnetic-threshold interrupt is controlled by m_ths_int_cfg bit located in register 0x52 (MAG_THS_CFG), and the magnetic vector-magnitude function routing is controlled by m_vecm_int_cfg bit in register 0x69 (M_VECM_CFG).

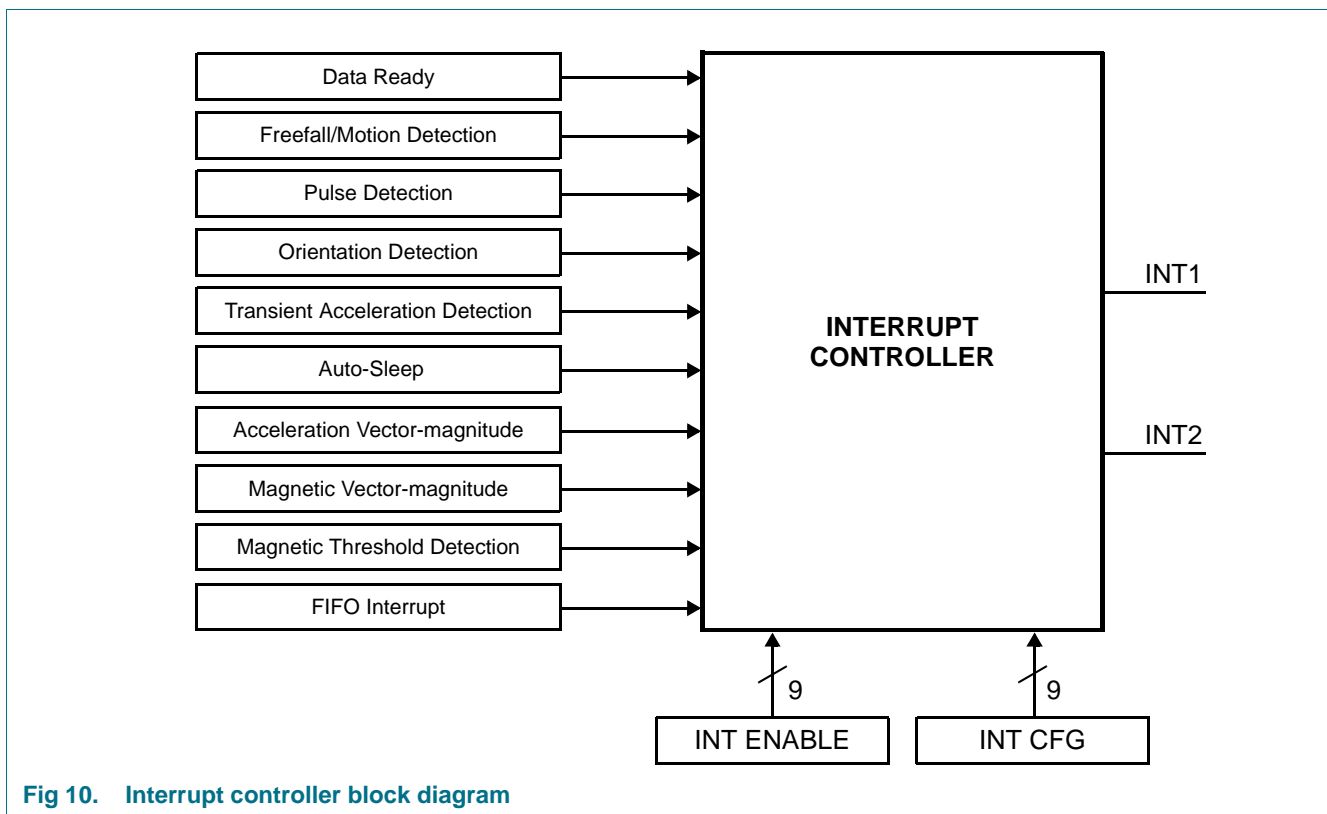
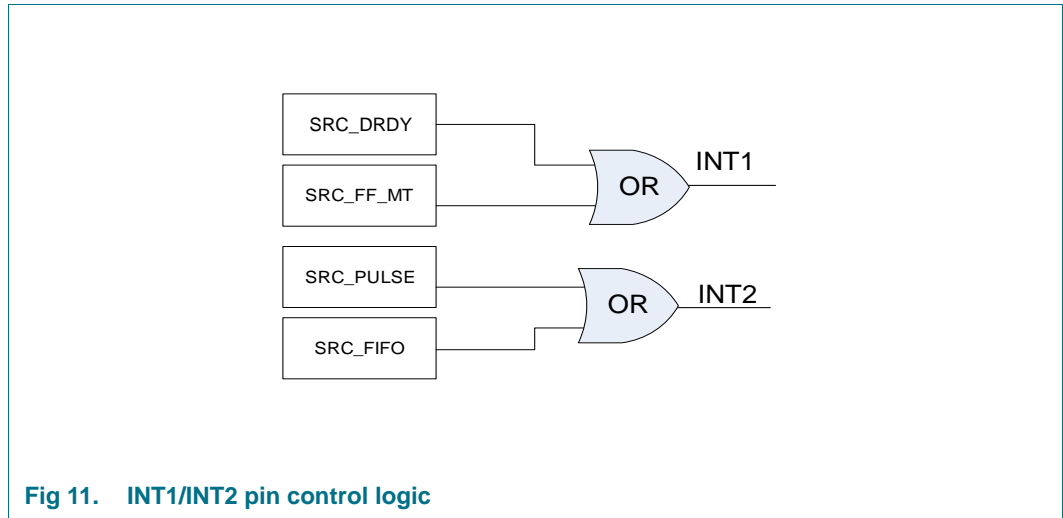

Fig 10. Interrupt controller block diagram

The system's interrupt controller uses the corresponding bit field in the CTRL_REG5 register to determine the routing for the INT1 and INT2 interrupt pins. For example, if the int_cfg_drdy bit value is logic '0' the functional block's interrupt is routed to INT2, and if the bit value is logic '1' then the interrupt is routed to INT1. All interrupt signals routed to either INT1 or INT2 are logically OR'd together as illustrated in Figure 11, thus one or more functional blocks can assert an interrupt pin simultaneously; therefore a host application responding to an interrupt should read the INT_SOURCE register to determine the source(s) of the interrupt(s).



14.2 Auto-sleep trigger register

14.2.1 ASLP_COUNT register (address 0x29)

The ASLP_COUNT register sets the minimum time period of event flag inactivity required to initiate a change from the current active mode ODR value specified in CTRL_REG1[dr] to the sleep mode ODR value specified in CTRL_REG1[aslp_rate], provided that CTRL_REG2[slope] = 1.

See [Table 49](#) for functional blocks that may be monitored for inactivity in order to trigger the return-to-sleep event.

Table 46. ASLP_COUNT register (address 0x29) bit allocation

Bit	7	6	5	4	3	2	1	0
Symbol	aslp_cnt[7:0]							
Reset	0	0	0	0	0	0	0	0
Access	R/W	R/W	R/W	R/W	R/W	R/W	R/W	R/W

Table 47. ASLP_COUNT register (address 0x29) bit description

Field	Description
aslp_cnt[7:0]	See Table 48 for details

Table 48. ASLP_COUNT relationship with ODR

Output data rate (ODR)	Maximum inactivity time (s)	ODR time step (ms)	ASLP_COUNT step (ms)
800	81	1.25	320
400	81	2.5	320
200	81	5	320
100	81	10	320
50	81	20	320
12.5	81	80	320
6.25	81	160	320
1.56	63	640	640

Please note that when the device is operated in hybrid mode, the effective ODR is half of what is selected in CTRL_REG1[dr]. For example, with ODR = 800 Hz and the device set to hybrid mode, the ASLP_COUNT time step becomes 640 ms.

Table 49. Sleep/wake mode gates and triggers

Interrupt source	Event restarts time and delays return-to-sleep	Event will wake-from-sleep
SRC_FIFO	Yes	No
SRC_TRANS	Yes	Yes
SRC_LNDPRT	Yes	Yes
SRC_PULSE	Yes	Yes
SRC_FFMT	Yes	Yes
SRC_ASLP	No ^[1]	No ^[1]
SRC_Mag	Yes	Yes
SRC_DRDY	No	No
SRC_AVECM	Yes	Yes
SRC_MVECM	Yes	Yes
SRC_MTHS	Yes	Yes
SRC_FIFO	Yes	No

[1] If the fifo_gate bit is set to logic '1', the assertion of the SRC_ASLP interrupt does not prevent the system from transitioning to sleep or from wake mode; instead it prevents the FIFO buffer from accepting new sample data until the host application flushes the FIFO buffer.

The interrupt sources listed in [Table 49](#) affect the auto-sleep, return to sleep and wake from sleep mechanism only if they have been previously enabled. The functional block event flags that are bypassed while the system is in auto-sleep mode are temporarily disabled ([Section 14.1.10](#)) and are automatically re-enabled when the device returns from auto-sleep mode (that is, wakes up), except for the data ready function.

If any of the interrupt sources listed under the return-to-sleep column is asserted before the sleep counter reaches the value specified in ASLP_COUNT, then all sleep mode transitions are terminated and the internal sleep counter is reset. If none of the interrupts listed under the return-to-sleep column are asserted within the time limit specified by the ASLP_COUNT register, the system will transition to the auto-sleep mode and use the ODR value specified in CTRL_REG1[aslp_rate].

If any of the interrupt sources listed under the “wake-from-sleep” column is asserted, then the system will transition out of the low sample rate auto-sleep mode to the user-specified wake mode sample rate provided that the specific wake event function is enabled in register CTRL_REG3.

If the auto-sleep interrupt is enabled, a transition from active mode to sleep mode and (vice-versa) will generate an interrupt. This interrupt is cleared by reading the SYSMOD (0x0B) register.

If CTRL_REG3[*fifo_gate*] = 1, a transition into auto-sleep mode will preserve the FIFO contents and set SYSMOD[*fgerr*] (FIFO gate error), and prevent the further collection of accelerometer data into the FIFO. The system will wait for the FIFO buffer to be emptied by the host application before new samples can be acquired.

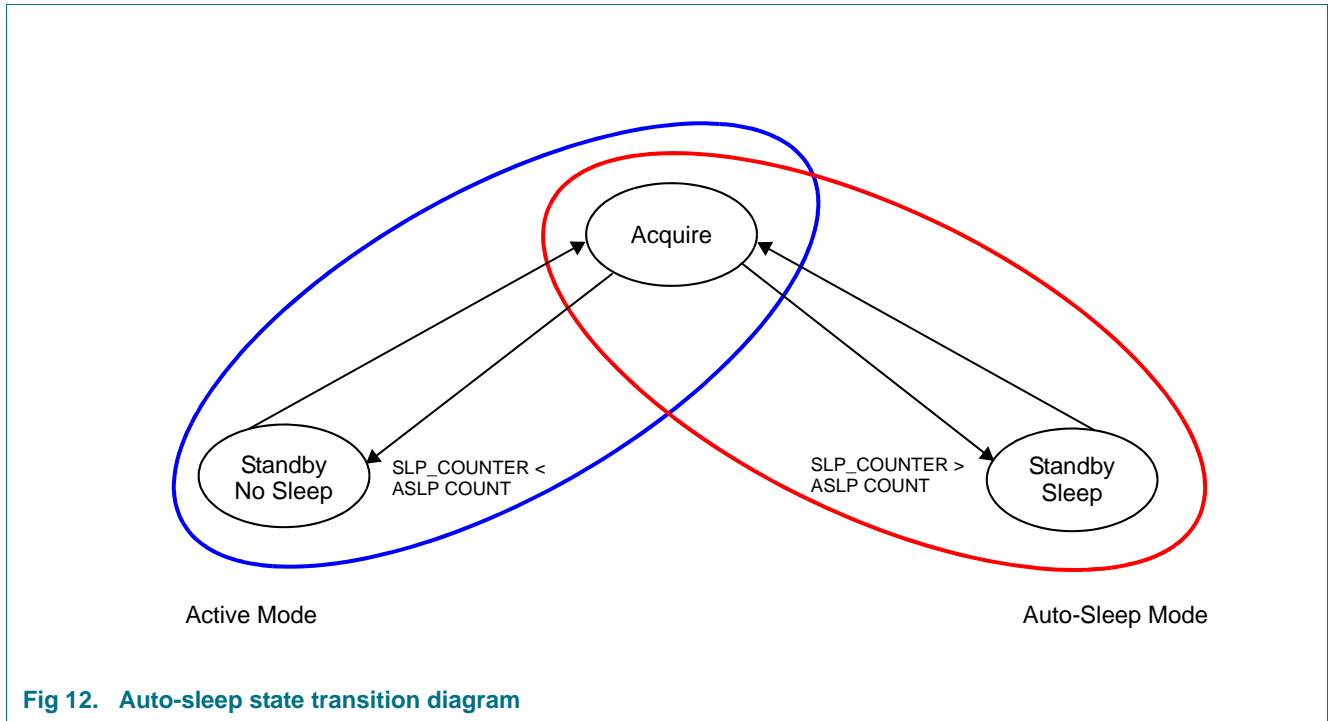

Fig 12. Auto-sleep state transition diagram

14.3 Temperature register

14.3.1 TEMP register (address 0x51)

Eight-bit 2's complement sensor temperature value with 0.96 °C/LSB sensitivity. Temperature data is only valid between -40 °C and 125 °C. The temperature sensor output is only valid when M_CTRL_REG1[m_hms] > 0b00. Please note that the temperature sensor is uncalibrated and its output for a given temperature will vary from one device to the next.

Table 50. TEMP register (address 0x51) bit allocation

Bit	7	6	5	4	3	2	1	0
Symbol	die_temperature[7:0]							
Reset	0	0	0	0	0	0	0	0
Access	R	R	R	R	R	R	R	R

14.4 Accelerometer output data registers

14.4.1 OUT_X_MSB, OUT_X_LSB, OUT_Y_MSB, OUT_Y_LSB, OUT_Z_MSB, OUT_Z_LSB (addresses 0x01 to 0x06) registers

These registers contain the X-axis, Y-axis, and Z-axis 14-bit left-justified sample data expressed as 2's complement numbers.

The sample data output registers store the current sample data if the FIFO buffer function is disabled, but if the FIFO buffer function is enabled the sample data output registers then point to the head of the FIFO buffer which contains up to the previous 32 X, Y, and Z data samples.

The data is read out in the following order: Xmsb, Xlsb, Ymsb, Ylsb, Zmsb, Zlsb for CTRL_REG1[f_read] = 0, and Xmsb, Ymsb, Zmsb for CTRL_REG1[f_read] = 1. If the device is operating in hybrid mode and M_CTRL_REG2[hyb_autoinc_mode] = 1, The data read out order is acceleration Xmsb, Xlsb, Ymsb, Ylsb, Zmsb, and Zlsb followed by magnetic data Xmsb, Xlsb, Ymsb, Ylsb, Zmsb, Zlsb. Similarly, for CTRL_REG1[f_read] = 1, only the MSB's of the acceleration and magnetic data are read out in the same axis order.

If the CTRL_REG1[f_read] bit is set, auto-increment will skip over the LSB registers. This will shorten the data acquisition from six bytes to three bytes. If the LSB registers are directly addressed, the LSB information can still be read regardless of the CTRL_REG1[f_read] register setting.

If the FIFO data output register driver is enabled (F_SETUP[f_mode] > 0b00), register 0x01 points to the head of the FIFO buffer, while registers 0x02, 0x03, 0x04, 0x05, 0x06 return a value of zero when read directly.

The DR_STATUS registers, OUT_X_MSB, OUT_X_LSB, OUT_Y_MSB, OUT_Y_LSB, OUT_Z_MSB, and OUT_Z_LSB are located in the auto-incrementing address range of 0x00 to 0x06, allowing all of the acceleration data to be read in a single-burst read of six bytes starting at the OUT_X_MSB register. If the device is operating in hybrid mode and M_CTRL_REG2[hyb_autoinc_mode] = 1, the magnetometer data can also be read out in the same axis and endian order by executing a burst read of 12 bytes starting at register OUT_X_MSB.

Table 51. OUT_X_MSB register (address 0x01) bit allocation

Bit	7	6	5	4	3	2	1	0
Symbol	xd[13:6]							
Reset	0	0	0	0	0	0	0	0
Access	R	R	R	R	R	R	R	R

Table 52. OUT_X_LSB register (address 0x02) bit allocation

Bit	7	6	5	4	3	2	1	0
Symbol	xd[5:0]						-	-
Reset	0	0	0	0	0	0	0	0
Access	R	R	R	R	R	R	R	R

Table 53. OUT_Y_MSB register (address 0x03) bit allocation

Bit	7	6	5	4	3	2	1	0
Symbol	yd[13:6]							
Reset	0	0	0	0	0	0	0	0
Access	R	R	R	R	R	R	R	R

Table 54. OUT_Y_LSB register (address 0x04) bit allocation

Bit	7	6	5	4	3	2	1	0
Symbol	yd[5:0]						-	-
Reset	0	0	0	0	0	0	0	0
Access	R	R	R	R	R	R	R	R

Table 55. OUT_Z_MSB register (address 0x05) bit allocation

Bit	7	6	5	4	3	2	1	0
Symbol	zd[13:6]							
Reset	0	0	0	0	0	0	0	0
Access	R	R	R	R	R	R	R	R

Table 56. OUT_Z_LSB register (address 0x06) bit allocation

Bit	7	6	5	4	3	2	1	0
Symbol	zd[5:0]						-	-
Reset	0	0	0	0	0	0	0	0
Access	R	R	R	R	R	R	R	R

14.5 Accelerometer FIFO register

14.5.1 F_SETUP register (address 0x09)

Table 57. F_SETUP register (address 0x09) bit allocation

Bit	7	6	5	4	3	2	1	0
Symbol	f_mode[1:0]		f_wmrk[5:0]					
Reset	0	0	0	0	0	0	0	0
Access	R/W	R/W	R/W	R/W	R/W	R/W	R/W	R/W

Table 58. F_SETUP register (address 0x09) bit descriptions

Field	Description
f_mode[1:0] [1] [2] [3]	<p>FIFO buffer operating mode.</p> <p>0b00 – FIFO is disabled.</p> <p>0b01 – FIFO contains the most recent samples when overflowed (circular buffer). Oldest sample is discarded to be replaced by new sample.</p> <p>0b10 – FIFO stops accepting new samples when overflowed.</p> <p>0b11 – FIFO trigger mode.</p> <p>The FIFO is flushed whenever the FIFO is disabled, during an automatic ODR change (auto-sleep/wake), or on a transition from standby mode to active mode.</p> <p>Disabling the FIFO (f_mode = 0b00) resets the F_STATUS[f_ovf], F_STATUS[f_wmrk_flag], F_STATUS[f_cnt] status flags to zero.</p> <p>A FIFO overflow event (that is, F_STATUS[f_cnt] = 32) will assert the F_STATUS[f_ovf] flag.</p>
f_wmrk[5:0] [2]	<p>FIFO sample count watermark.</p> <p>These bits set the number of FIFO samples required to trigger a watermark interrupt. A FIFO watermark event flag F_STATUS[f_wmk_flag] is raised when FIFO sample count F_STATUS[f_cnt] value is equal to or greater than the f_wmrk watermark.</p> <p>Setting the f_wmrk to 0b00_0000 will disable the FIFO watermark event flag generation.</p> <p>This field is also used to set the number of pre-trigger samples in trigger mode (f_mode = 0b11).</p>

[1] This bit field can be written in active mode.

[2] This bit field can be written in standby mode.

[3] The FIFO mode (f_mode) cannot be switched between operational modes (0b01, 0b10 and 0b11).

A FIFO sample count exceeding the watermark event does not stop the FIFO from accepting new data.

The FIFO update rate is dictated by the selected system ODR. In active mode the ODR is set by CTRL_REG1[dr] and when auto-sleep is active, the ODR is set by CTRL_REG1[aslp_rate] bit fields.

When data is read from the FIFO buffer, the oldest sample data in the buffer is returned and also deleted from the front of the FIFO, while the FIFO sample count is decremented by one. It is assumed that the host application will use the I²C or SPI burst-read transactions to dump the FIFO contents. If the FIFO X, Y, and Z data is not completely read in one burst-read transaction, the next read will start at the next FIFO location X-axis data. If the Y or Z data is not read out in the same burst transaction as the X-axis data, it will be lost.

In trigger mode, the FIFO is operated as a circular buffer and will contain up to the 32 most recent acceleration data samples. The oldest sample is discarded and replaced by the current sample, until a FIFO trigger event occurs. After a trigger event occurs, the FIFO will continue to accept samples only until overflowed, after which point the newest sample data is discarded. For more information on using the FIFO buffer and the various FIFO operating modes, please refer to NXP application note AN4073.

14.6 Accelerometer sensor data configuration register

14.6.1 XYZ_DATA_CFG register (address 0x0E)

The XYZ_DATA_CFG register is used to configure the desired acceleration full-scale range, and also to select whether the output data is passed through the high-pass filter.

Table 59. XYZ_DATA_CFG register (address 0x0E) bit allocation

Bit	7	6	5	4	3	2	1	0
Symbol	-	-	-	hpf_out	-	-	fs[1:0]	
Reset	0	0	0	0	0	0	0	0
Access	R/W	R/W	R/W	R/W	R/W	R/W	R/W	R/W

Table 60. XYZ_DATA_CFG register (address 0x0E) bit descriptions

Field	Description
hpf_out	Enable high-pass filter on acceleration output data 1 – Output data is high-pass filtered 0 – High-pass filter is disabled.
fs[1:0]	Accelerometer full-scale range selection. See Table 61 .

Table 61. Full-scale range selection

fs[1]	fs[0]	Sensitivity	Full-scale range
0	0	±0.244 mg/LSB	±2 g
0	1	±0.488 mg/LSB	±4 g
1	0	±0.976 mg/LSB	±8 g
1	1	Reserved	-

14.7 Accelerometer high-pass filter register

14.7.1 HP_FILTER_CUTOFF register (address 0x0F)

High-pass filter cutoff frequency setting register.

Table 62. HP_FILTER_CUTOFF register (address 0x0F) bit allocation

Bit	7	6	5	4	3	2	1	0
Symbol	-	-	pulse_hpf_byp	pulse_lpf_en	-	-	sel[1:0]	
Reset	0	0	0	0	0	0	0	0
Access	R/W	R/W	R/W	R/W	R/W	R/W	R/W	R/W

Table 63. HP_FILTER_CUTOFF register (address 0x0F) bit descriptions

Field	Description
pulse_hpf_byp	Bypass high-pass filter for pulse processing function 0 – HPF enabled for pulse processing 1 – HPF bypassed for pulse processing
pulse_lpf_en	Enable low-pass filter for pulse processing function 0 – LPF disabled for pulse processing 1 – LPF enabled for pulse processing
sel[1:0]	HPF cutoff frequency selection See Table 64 .

Table 64. HP_FILTER_CUTOFF

High-Pass cutoff frequency (Hz)								
ODR (Hz)	sel = 0b00				sel = 0b01			
	Normal	LPLN	High resolution	Low power	Normal	LPLN	High resolution	Low power
800	16	16	16	16	8	8	8	8
400	16	16	16	8	8	8	8	4
200	8	8	16	4	4	4	8	2
100	4	4	16	2	2	2	8	1
50	2	2	16	1	1	1	8	0.5
12.5	2	0.5	16	0.25	1	0.25	8	0.125
6.25	2	0.25	16	0.125	1	0.125	8	0.063
1.56	2	0.063	16	0.031	1	0.031	8	0.016
800	4	4	4	4	2	2	2	2
400	4	4	4	2	2	2	2	1
200	2	2	4	1	1	1	2	0.5
100	1	1	4	0.5	0.5	0.5	2	0.25
50	0.5	0.5	4	0.25	0.25	0.25	2	0.125
12.5	0.5	0.125	4	0.063	0.25	0.063	2	0.031
6.25	0.5	0.063	4	0.031	0.25	0.031	2	0.016
1.56	0.5	0.016	4	0.008	0.25	0.008	2	0.004

Please note that when the part is operated in hybrid mode, the ODR is reduced by a factor of two, which also affects the filter cutoff frequency. For example, an ODR setting of 400 Hz in accelerometer only mode with HP_FILTER_CUTOFF[sel] = 0b10 sets the cutoff frequency at 4 Hz. If the part is operated in Hybrid mode, the effective ODR becomes 200 Hz and the cutoff frequency is now 2 Hz for the same ODR and HP_FILTER_CUTOFF[sel] settings.

14.8 Portrait/landscape detection registers

The FXOS8700CQ is capable of detecting six orientations: landscape left, landscape right, portrait up, and portrait down with Z-lockout feature as well as face up and face down orientation as shown in [Figure 13](#), [14](#), and [15](#). For more details on the meaning of the different user-configurable settings and for example code, please refer to NXP application note AN4068.

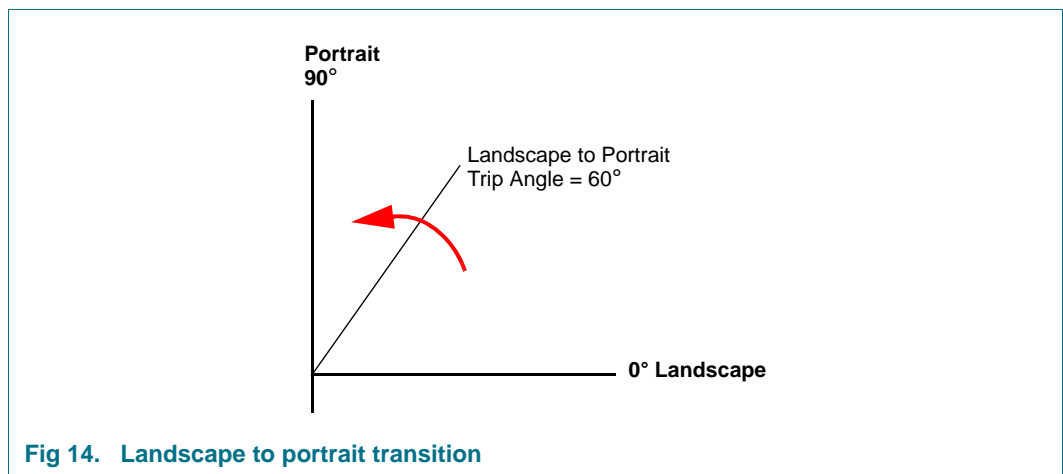
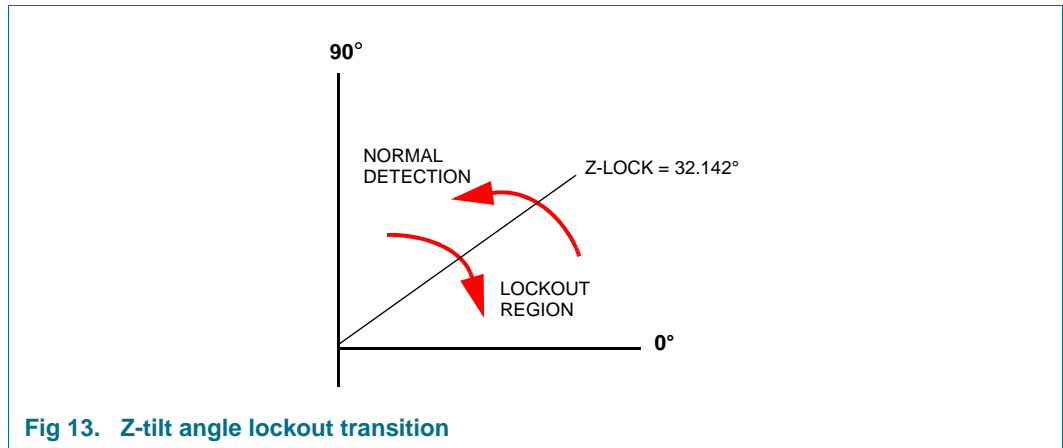

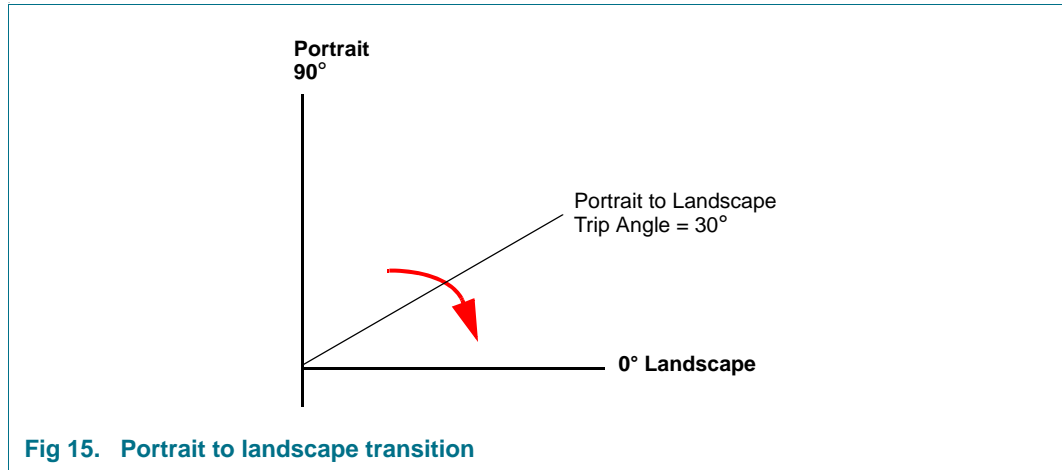

Fig 15. Portrait to landscape transition

14.8.1 PL_STATUS register (address 0x10)

This status register can be read to get updated information on any change in orientation by reading bit 7, or the specifics of the orientation by reading the other bits. For further understanding of portrait up, portrait down, landscape left, landscape right, back and front orientations refer to [Figure 4](#). The interrupt is cleared when reading the PL_STATUS register.

Table 65. PL_STATUS register (address 0x10) bit allocation

Bit	7	6	5	4	3	2	1	0
Symbol	newlp	lo	-	-	-	lapo[1:0]		bafro
Reset	0	0	0	0	0	0	0	0
Access	R	R	R	R	R	R	R	R

Table 66. PL_STATUS register (address 0x10) bit descriptions

Field	Description
newlp	Landscape/portrait status change flag. 0 – No change 1 – BAFRO and/or LAPO and/or Z-tilt lockout value has changed
lo	Z-tilt angle lockout. 0 – Lockout condition has not been detected 1 – Z-tilt lockout trip angle has been exceeded. Lockout condition has been detected
lapo[1:0] ^[1]	Landscape/portrait orientation 0b00 – Portrait up: equipment standing vertically in the normal orientation 0b01 – Portrait down: equipment standing vertically in the inverted orientation 0b10 – Landscape right: equipment is in landscape mode to the right 0b11 – Landscape left: equipment is in landscape mode to the left
bafro	Back or front orientation. 0 – Front: equipment is in the front facing orientation 1 – Back: equipment is in the back facing orientation

[1] The default powerup state is bafro(Undefined), lapo(Undefined), and no lockout for orientation function.

The newlp bit is set to 1 after the first orientation detection after a standby to active transition, and whenever a change in lo, bafro, or lapo occurs. The newlp bit is cleared anytime the PL_STATUS register is read. lapo, bafro and lo continue to change when newlp is set. The current orientation is locked if the absolute value of the acceleration experienced on any of the three axes is greater than 1.25 g.

14.8.2 PL_CFG register (address 0x11)

This register enables the portrait/landscape function and sets the behavior of the debounce counter.

Table 67. PL_CFG register (address 0x11) bit allocation

Bit	7	6	5	4	3	2	1	0
Symbol	dbcntm	pl_en	-	-	-	-	-	-
Reset	1	0	0	0	0	0	0	0
Access	R/W	R/W	R/W	R/W	R/W	R/W	R/W	R/W

Table 68. PL_CFG register (address 0x11) bit descriptions

Field	Description
dbcntm	Debounce counter mode selection. 0 – Decrements debounce whenever condition of interest is no longer valid. 1 – Clears counter whenever condition of interest is no longer valid
pl_en	Portrait/landscape detection enable. 0 – Portrait/landscape detection is disabled. 1 – Portrait/landscape detection is enabled

14.8.3 PL_COUNT register (address 0x12)

This register sets the debounce count for the orientation state transition. The minimum debounce latency is determined by the system ODR value and the value of the PL_COUNT register. Any change to the system ODR or a transition from active-to-standby (or vice-versa) resets the internal landscape/portrait internal debounce counters. When the device is operated in hybrid mode, the effective ODR will be half of what is selected by the user, which will also affect the debounce time. For example, if an ODR of 400 Hz is selected and the part is also in hybrid mode, the effective ODR is 200 Hz, and the effective debounce time step is 5 ms instead of 2.5 ms.

Table 69. PL_COUNT register (address 0x12) bit allocation

Bit	7	6	5	4	3	2	1	0
Symbol	dbnce[7:0]							
Reset	0	0	0	0	0	0	0	0
Access	R/W	R/W	R/W	R/W	R/W	R/W	R/W	R/W

Table 70. PL_Count Relationship with the ODR

ODR (Hz)	Max time range (s)				Time step (ms)			
	Normal	LPLN	High resolution	Low power	Normal	LPLN	High resolution	Low power
800	0.319	0.319	0.319	0.319	1.25	1.25	1.25	1.25
400	0.638	0.638	0.638	0.638	2.5	2.5	2.5	2.5
200	1.28	1.28	0.638	1.28	5	5	2.5	5
100	2.55	2.55	0.638	2.55	10	10	2.5	10
50	5.1	5.1	0.638	5.1	20	20	2.5	20
12.5	5.1	20.4	0.638	20.4	20	80	2.5	80
6.25	5.1	20.4	0.638	40.8	20	80	2.5	160
1.56	5.1	20.4	0.638	40.8	20	80	2.5	160

14.8.4 PL_BF_ZCOMP register (address 0x13)

Back/front and Z-tilt angle compensation register.

Table 71. PL_BF_ZCOMP register (address 0x13) bit allocation

Bit	7	6	5	4	3	2	1	0
Symbol	bkfr[1:0]		-	-	-	zlock[2:0]		
Reset	1	0	0	0	0	1	0	0
Access	R/W	R/W	R/W	R/W	R/W	R/W	R/W	R/W

Table 72. PL_BF_ZCOMP register (address 0x13) bit descriptions

Field	Description
zlock[2:0]	Z-lock angle threshold. range is from approximately 13° to 44°. Step size is approximately 4°. See Table 73 for more information. Default value: 0x04 → -28° Maximum value: 0x07 → -44°
bkfr[1:0]	Back/front trip angle threshold. See Table 74 for more information. Default: 0b10 → ±70° . Step size is 5°. Range: ±(65° to 80°)

Table 73. Z-lockout angle definitions

zlock	Resultant angle (min) for positions between landscape and portrait	Resultant angle (max) for ideal landscape or portrait
0b000	13.6°	14.5°
0b001	17.1°	18.2°
0b010	20.7°	22.0°
0b011	24.4°	25.9°
0b100	28.1°	30.0°
0b101	32.0°	34.2°
0b110	36.1°	38.7°
0b111	40.4°	43.4°

Table 74. Back/front orientation definitions

bkfr	Back → front transition	Front → back transition
0b00	Z < 80° or Z > 280°	Z > 100° and Z < 260°
0b01	Z < 75° or Z > 285°	Z > 105° and Z < 255°
0b10	Z < 70° or Z > 290°	Z > 110° and Z < 250°
0b11	Z < 65° or Z > 295°	Z > 115° and Z < 245°

14.8.5 PL_THS_REG register (address 0x14)

Portrait to landscape trip threshold registers.

Table 75. PL_THS_REG register (address 0x14) bit allocation

Bit	7	6	5	4	3	2	1	0
Symbol	pl_ths[4:0]				hys[2:0]			
Reset	0	1	0	0	0	1	0	0
Access	R/W	R/W	R/W	R/W	R/W	R/W	R/W	R/W

Table 76. Threshold angle lookup table

pl_ths[4:0] value	Threshold angle (approx.)
0x07	15°
0x09	20°
0x0C	30°
0x0D	35°
0x0F	40°
0x10	45°
0x13	55°
0x14	60°
0x17	70°
0x19	75°

Table 77. Trip angles versus hysteresis settings

hys[2:0] value	Landscape to portrait trip angle	Portrait to landscape trip angle
0b000	45°	45°
0b001	49°	41°
0b010	52°	38°
0b011	56°	34°
0b100	59°	31°
0b101	62°	28°
0b110	66°	24°
0b111	69°	21°

Table 78. Portrait/landscape ideal orientation definitions

Position	Description
PU	y ~ -1 g, x ~ 0
PD	y ~ +1 g, x ~ 0
LR	y ~ 0, x ~ +1 g
LL	y ~ 0, x ~ -1 g

14.9 Freefall and motion detection registers

The freefall/motion detection block can be configured to detect low-g (freefall) or high-g (motion) events utilizing the A_FFMT_CFG[a_ffmt_oae] bit.

In low-g detect mode (A_FFMT_CFG[a_ffmt_oae] = 0) a low-g condition will need to occur on all enabled axes (ex. X, Y and Z) for the A_FFMT_SRC[a_ffmt_ea] bit to be affected. And, in high-g detect mode (A_FFMT_CFG[a_ffmt_oae] = 1) a high-g condition occurring in any of the enabled axes (ex. X, Y or Z) will suffice to affect the A_FFMT_SRC[a_ffmt_ea] bit.

The detection threshold(s) are programed in register 0x17 (A_FFMT_THS) for common threshold operation, and 0x73-0x78 (A_FFMT_THS_X/Y/Z) for individual axis threshold operation.

A_FFMT_CFG[a_ffmt_ele] bit determines the behavior of A_FFMT_SRC[a_ffmt_ea] bit in response to the desired acceleration event (low-g/high-g). When A_FFMT_CFG[a_ffmt_ele] = 1, the freefall or motion event is latched and the A_FFMT_SRC[a_ffmt_ea] flag can only be cleared by reading the A_FFMT_SRC register. When A_FFMT_CFG[a_ffmt_ele] = 0, freefall or motion events are not latched, and the A_FFMT_SRC[a_ffmt_ea] bit reflects the real-time status of the event detection.

A_FFMT_THS[a_ffmt_dbcntm] bit determines the debounce filtering behavior of the logic which sets the A_FFMT_SRC[a_ffmt_ea] bit. See [Table 17](#) for details.

It is possible to enable/disable each axis used in the freefall/motion detection function by configuring bits A_FFMT_CFG[a_ffmt_xefe], A_FFMT_CFG[a_ffmt_yefe], and A_FFMT_CFG[a_ffmt_zefe].

The freefall/motion detection function has the option to use a common 7-bit unsigned threshold for each of the X, Y, and Z axes, or individual unsigned 13-bit thresholds for each axis. When A_FFMT_THS_X_MSB[a_ffmt_ths_xyz_en] = 0, the 7-bit threshold value stored in register 0x17 is used as a common 7-bit threshold for the X, Y, and Z axes. When a_ffmt_ths_xyz_en = 1, each axis may be programmed with an individual 13-bit threshold (stored in the A_FFMT_X/Y/Z MSB and LSB registers).

14.9.1 A_FFMT_CFG register (address 0x15)

Freefall/motion configuration register.

Table 79. A_FFMT_CFG register (address 0x15) bit allocation

Bit	7	6	5	4	3	2	1	0
Symbol	a_ffmt_ele	a_ffmt_oae	a_ffmt_zefe	a_ffmt_yefe	a_ffmt_xefe	-	-	-
Reset	0	0	0	0	0	0	0	0
Access	R/W	R/W	R/W	R/W	R/W	R/W	R/W	R/W

Table 80. A_FFMT_CFG register (address 0x15) bit descriptions

Field	Description
a_ffmt_ele	a_ffmt_ele denotes whether the enabled event flag will be latched in the A_FFMT_SRC register or the event flag status in the A_FFMT_SRC will indicate the real-time status of the event. If a_ffmt_ele bit is set to a logic '1', then the event flags are frozen when the a_ffmt_ea bit gets set, and are cleared by reading the A_FFMT_SRC source register. 0 – Event flag latch disabled 1 – Event flag latch enabled
a_ffmt_oae	a_ffmt_oae bit allows the selection between motion (logical OR combination of high-g X, Y, and Z-axis event flags) and freefall (logical AND combination of low-g X, Y, and Z-axis event flags) detection. Motion detect/freefall detect logic selection. 0 – Freefall flag (logical AND combination of low-g X, Y, and Z-axis event flags) 1 – Motion flag (logical OR combination of high-g X, Y, and Z-axis event flags)
a_ffmt_zeffe	a_ffmt_zeffe enables the detection of a high- or low-g event when the measured acceleration data on Z-axis is above/below the threshold set in the A_FFMT_THS register. If the a_ffmt_ele bit is set to logic '1' in the A_FFMT_CFG register, new event flags are blocked from updating the A_FFMT_SRC register. 0 – Event detection disabled 1 – Raise event flag on measured Z-axis acceleration above/below threshold.
a_ffmt_yefe	a_ffmt_yefe enables the detection of a high- or low-g event when the measured acceleration data on Y-axis is above/below the threshold set in the A_FFMT_THS register. If the a_ffmt_ele bit is set to logic '1' in the A_FFMT_CFG register, new event flags are blocked from updating the A_FFMT_SRC register. 0 – Event detection disabled 1 – Raise event flag on measured Y-axis acceleration above/below threshold.
a_ffmt_xefe	a_ffmt_xefe enables the detection of a high- or low-g event when the measured acceleration data on X-axis is above/below the threshold set in the A_FFMT_THS register. If the a_ffmt_ele bit is set to logic '1' in the A_FFMT_CFG register, new event flags are blocked from updating the A_FFMT_SRC register. 0 – Event detection disabled 1 – Raise event flag on measured X-axis acceleration above/below threshold.

14.9.2 A_FFMT_SRC register (address 0x16)

Freefall/motion source register. Read-only register.

This register keeps track of the acceleration event which is triggering (or has triggered, in case of A_FFMT_CFG[a_ffmt_ele] = 1) the event flag. In particular A_FFMT_SRC[a_ffmt_ea] is set to a logic '1' when the logical combination of acceleration event flags specified in A_FFMT_CFG register is true. This bit is used in combination with the values in CTRL_REG4[int_en_ffmt] and CTRL_REG5[int_cfg_ffmt] register bits to generate the freefall/motion interrupts.

Table 81. A_FFMT_SRC register (address 0x16) bit allocation

Bit	7	6	5	4	3	2	1	0
Symbol	a_ffmt_ea	-	a_ffmt_zhe	a_ffmt_zhp	a_ffmt_yhe	a_ffmt_yhp	a_ffmt_xhe	a_ffmt_xhp
Reset	0	0	0	0	0	0	0	0
Access	R/W	R/W	R/W	R/W	R/W	R/W	R/W	R/W

Table 82. A_FFMT_SRC register (address 0x16) bit descriptions

Field	Description
a_ffmt_ea	Event active flag. 0 – No event flag has been asserted 1 – One or more event flag has been asserted. See Table 80 for the description of the A_FFMT_CFG[a_ffmt_oe] bit to determine the effect of the 3-axis event flags on the a_ffmt_ea bit.
a_ffmt_zhe	Z-high event flag. 0 – Event detected 1 – Z-high event has been detected This bit always reads zero if the a_ffmt_zefe control bit is set to zero
a_ffmt_zhp	Z-high event polarity flag. 0 – Z event was positive <i>g</i> 1 – Z event was negative <i>g</i> This bit read always zero if the a_ffmt_zefe control bit is set to zero
a_ffmt_yhe	Y-high event flag. 0 – No event detected 1 – Y-high event has been detected This bit read always zero if the a_ffmt_yefe control bit is set to zero
a_ffmt_yhp	Y-high event polarity flag. 0 – Y event detected was positive <i>g</i> 1 – Y event was negative <i>g</i> This bit always reads zero if the a_ffmt_yefe control bit is set to zero
a_ffmt_xhe	X-high event flag. 0 – No event detected 1 – X-high event has been detected This bit always reads zero if the a_ffmt_xefe control bit is set to zero
a_ffmt_xhp	X-high event polarity flag. 0 – X event was positive <i>g</i> 1 – X event was negative <i>g</i> This bit always reads zero if the a_ffmt_xefe control bit is set to zero

14.9.3 A_FFMT_THS register (address 0x17)

Freefall/motion detection threshold registers.

Table 83. A_FFMT_THS register (address 0x17) bit allocation

Bit	7	6	5	4	3	2	1	0
Symbol	a_ffmt_dbcntm				ths[6:0]			
Reset	0	0	0	0	0	0	0	0
Access	R/W	R/W	R/W	R/W	R/W	R/W	R/W	R/W

Table 84. A_FFMT_THS register (address 0x17) bit descriptions

Field	Description
a_ffmt_dbcntm	<p>The ASIC uses a_ffmt_dbcntm to set the acceleration FFMT debounce counter clear mode independent of the value of the a_ffmt_ths_xyz_en.</p> <p>a_ffmt_dbcntm bit configures the way in which the debounce counter is reset when the inertial event of interest is momentarily not true.</p> <p>When a_ffmt_dbcntm bit is a logic '1', the debounce counter is cleared to 0 whenever the inertial event of interest is no longer true (part b, Table 17) while if the a_ffmt_dbcntm bit is set to logic '0' the debounce counter is decremented by 1 whenever the inertial event of interest is longer true (part c, Table 17) until the debounce counter reaches 0 or the inertial event of interest become active.</p> <p>The decrementing of the debounce counter acts to filter out irregular spurious events which might impede the correct detection of inertial events.</p>
ths[6:0]	Freefall/motion detection threshold: default value: 0b000_0000. Resolution is fixed at 63 mg/LSB.

14.9.4 A_FFMT_THS_X_MSB, A_FFMT_THS_X_LSB, A_FFMT_THS_Y_MSB, A_FFMT_THS_Y_LSB, A_FFMT_THS_Z_MSB, A_FFMT_THS_Z_LSB registers (addresses 0x73 to 0x78)

Table 85. A_FFMT_THS_X_MSB register (address 0x73) bit allocation

Bit	7	6	5	4	3	2	1	0
Symbol	a_ffmt_ths_xyz_en	a_ffmt_ths_x[12:6]						
Reset	0	0	0	0	0	0	0	0
Access	R/W	R/W	R/W	R/W	R/W	R/W	R/W	R/W

Table 86. A_FFMT_THS_X_MSB register (address 0x73) bit descriptions

Field	Description
a_ffmt_ths_xyz_en	<p>For a_ffmt_ths_xyz_en = 0 the ASIC uses the ffmt_ths[6:0] value located in register 0x17[6:0] as a common threshold for the X, Y, and Z-axis acceleration detection. The common unsigned 7-bit acceleration threshold has a fixed resolution of 63 mg/LSB, with a range of 0 to 127 counts.</p> <p>For a_ffmt_ths_xyz_en = 1 the ASIC ignores the common 7-bit G_FFMT_THS value located in register 0x17 when executing the FFMT function, and the following independent threshold values are used for each axis:</p> <p>A_FFMT_THS_X_MSB and A_FFMT_THS_X_LSB are used for the X-axis acceleration threshold, A_FFMT_THS_Y_MSB and A_FFMT_THS_Y_LSB for the Y-axis acceleration threshold, and A_FFMT_THS_Z_MSB and A_FFMT_THS_Z_LSB for the Z-axis acceleration threshold.</p> <p>The A_FFMT_THS_X/Y/Z thresholds are 13-bit unsigned values that has a fixed resolution of about 63 mg/LSB. The a_ffmt_ths_xyz_en and a_ffmt_trans_ths_en bits must not be enabled simultaneously.</p>
a_ffmt_ths_x[12:6]	7-bit MSB of X-axis acceleration threshold.

Table 87. A_FFMT_THS_X_LSB register (address 0x74) bit allocation

Bit	7	6	5	4	3	2	1	0
Symbol	a_ffmt_ths_x[5:0]						-	-
Reset	0	0	0	0	0	0	0	0
Access	R/W	R/W	R/W	R/W	R/W	R/W	R/W	R/W

Table 88. A_FFMT_THS_Y_MSB register (address 0x75) bit allocation

Bit	7	6	5	4	3	2	1	0
Symbol	a_ffmt_trans_ths_en	a_ffmt_ths_y[12:6]						
Reset	0	0	0	0	0	0	0	0
Access	R/W	R/W	R/W	R/W	R/W	R/W	R/W	R/W

Table 89. A_FFMT_THS_Y_LSB register (address 0x76) bit allocation

Bit	7	6	5	4	3	2	1	0
Symbol	a_ffmt_ths_y[5:0]						-	-
Reset	0	0	0	0	0	0	0	0
Access	R/W	R/W	R/W	R/W	R/W	R/W	R/W	R/W

Table 90. A_FFMT_THS_Z_MSB register (address 0x77) bit allocation

Bit	7	6	5	4	3	2	1	0
Symbol	-	a_ffmt_ths_z[12:6]						
Reset	0	0	0	0	0	0	0	0
Access	R/W	R/W	R/W	R/W	R/W	R/W	R/W	R/W

Table 91. A_FFMT_THS_Z_LSB register (address 0x78) bit allocation

Bit	7	6	5	4	3	2	1	0
Symbol	a_ffmt_ths_zy[5:0]						-	-
Reset	0	0	0	0	0	0	0	0
Access	R/W	R/W	R/W	R/W	R/W	R/W	R/W	R/W

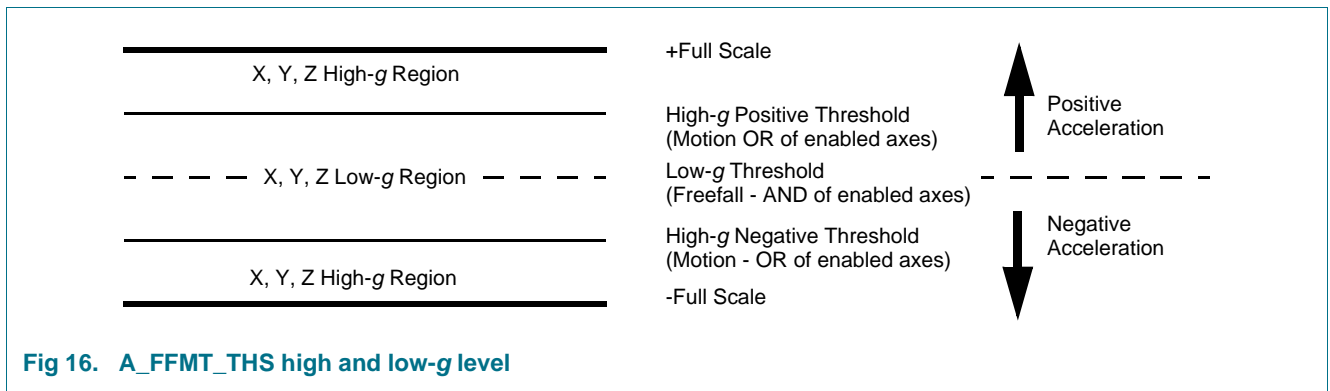

Fig 16. A_FFMT_THS high and low-g level

A_FFMT_THS contains the unsigned 7-bit threshold value used by the freefall/motion detection functional block and is used to detect either low-g (freefall) or high-g (motion) events depending on the setting of G_FFMT_CFG[f_ffmt_oe]. If g_ffmt_oe = 0, the event is detected when the absolute value of all the enabled axes are below the threshold value. When g_ffmt_oe = 1, the event is detected when the absolute value of any of the enabled axes is above the threshold value (see [Figure 16](#) for an illustration of the freefall/motion event detection thresholds). If A_FFMT_THS_X_MSB[a_ffmt_ths_xyz_en] = 1, the behavior is identical, except that each axis may be programmed with an individual 13-bit threshold (stored in the A_FFMT_X/Y/Z MSB and LSB registers).

14.9.5 A_FFMT_COUNT register (address 0x18)

Debounce count register for freefall/motion detection events

This register sets the number of debounce counts for acceleration sample data matching the user-programmed conditions for either a freefall or motion detection event required before the interrupt is triggered.

Table 92. A_FFMT_COUNT register (address 0x18) bit allocation

Bit	7	6	5	4	3	2	1	0
Symbol	a_ffmt_count[7:0]							
Reset	0	0	0	0	0	0	0	0
Access	R/W	R/W	R/W	R/W	R/W	R/W	R/W	R/W

Table 93. A_FFMT_COUNT register (address 0x18) bit description

Field	Description
a_ffmt_count[7:0]	a_ffmt_count defines the minimum number of debounce sample counts required for the detection of a freefall or motion event. A_FFMT_THS[ffmt_dbcntm] determines the behavior of the counter when the condition of interest is momentarily not true.

When the internal debounce counter reaches the A_FFMT_COUNT value a freefall/motion event flag is set. The debounce counter will never increase beyond the A_FFMT_COUNT value. The time step used for the debounce sample count depends on the ODR chosen (see Table 94). When the device is operated in hybrid mode, the effective ODR is half of what is selected in CTRL_REG1. This has the effect of doubling the time-step values shown in Table 94.

Table 94. A_FFMT_COUNT relationship with the ODR

ODR (Hz)	Max time range (s)				Time step (ms)			
	Normal	LPLN	High resolution	Low power	Normal	LPLN	High resolution	LP
800	0.319	0.319	0.319	0.319	1.25	1.25	1.25	1.25
400	0.638	0.638	0.638	0.638	2.5	2.5	2.5	2.5
200	1.28	1.28	0.638	1.28	5	5	2.5	5
100	2.55	2.55	0.638	2.55	10	10	2.5	10
50	5.1	5.1	0.638	5.1	20	20	2.5	20
12.5	5.1	20.4	0.638	20.4	20	80	2.5	80
6.25	5.1	20.4	0.638	40.8	20	80	2.5	160
1.56	5.1	20.4	0.638	40.8	20	80	2.5	160

For example, an ODR of 100 Hz and a A_FFMT_COUNT value of 15 would result in minimum debounce response time of 150 ms. If the device is operated in hybrid mode, the effective debounce response time will be 300 ms for the same settings.

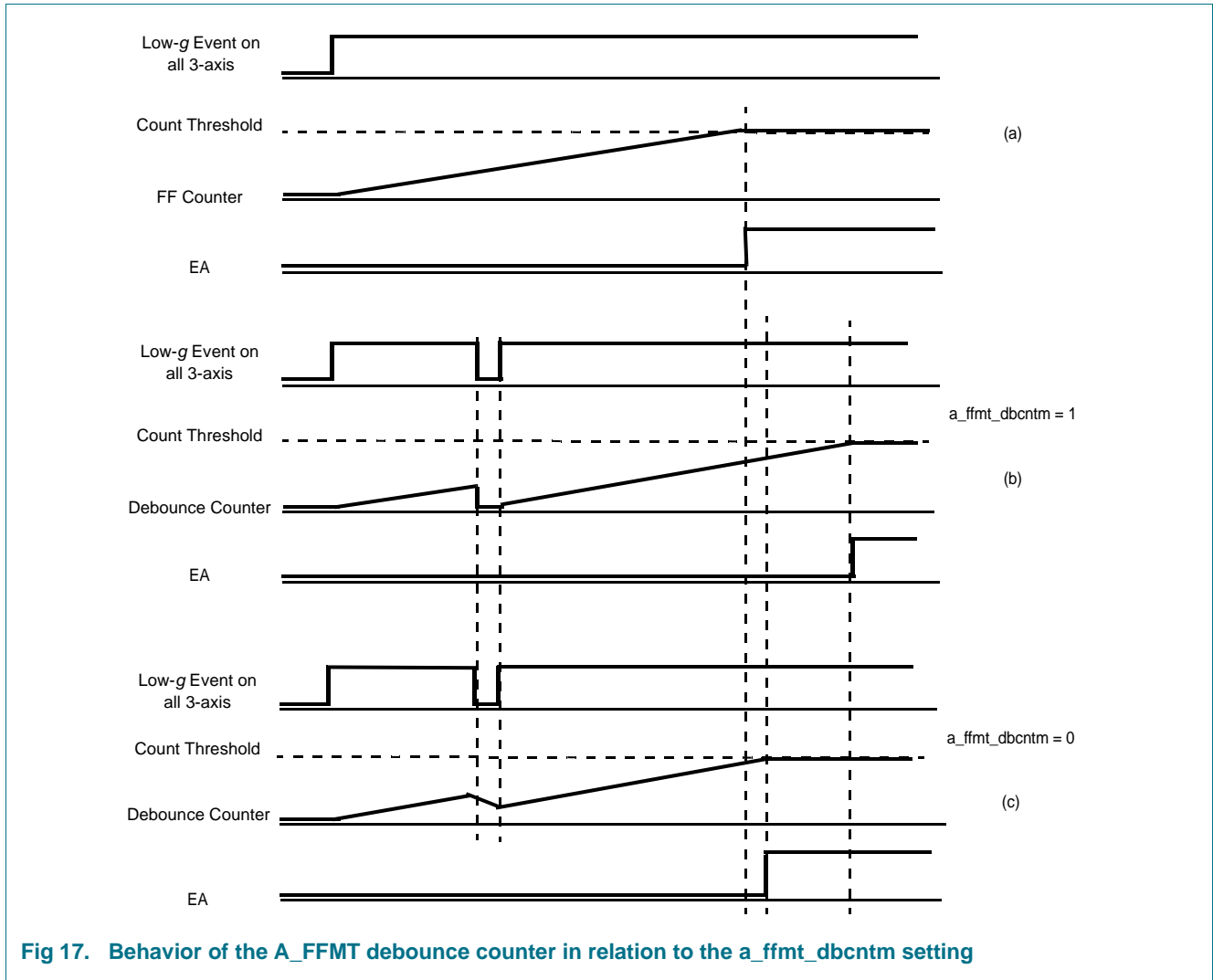

Fig 17. Behavior of the A_FFMT debounce counter in relation to the a_ffmt_dbcntm setting

14.10 Accelerometer vector-magnitude function register

The accelerometer vector-magnitude function is an inertial event detection function available to assist host software algorithms in detecting motion events.

If $\sqrt{(a_{x_out} - a_{x_ref})^2 + (a_{y_out} - a_{y_ref})^2 + (a_{z_out} - a_{z_ref})^2} > A_VECM_THS$ for a time period greater than the value stored in `A_VECM_CNT`, the vector-magnitude change event flag is triggered.

`a_x_out`, `a_y_out`, and `a_z_out` are the current accelerometer output values, and `a_x_ref`, `a_y_ref`, and `a_z_ref` are the reference values stored internally in the ASIC for each axis or in `A_VECM_INIT_X/Y/Z` registers if `A_VECM_CFG[a_vecm_initm]` is set.

Please note that the `x_ref`, `y_ref`, and `z_ref` values are not directly visible to the host application through the register interface. Please refer to NXP application note AN4458.

14.10.1 A_VECM_CFG register (address 0x5F)

Table 95. A_VECM_CFG register (address 0x5F) bit allocation

Bit	7	6	5	4	3	2	1	0
Symbol	-	a_vecm_ele	a_vecm_initm	a_vecm_updm	a_vecm_en	-	-	-
Reset	0	0	0	0	0	0	0	0
Access	R/W	R/W	R/W	R/W	R/W	R/W	R/W	R/W

Table 96. A_VECM_CFG register (address 0x5F) bit descriptions

Field	Description
a_vecm_ele	Control bit a_vecm_ele defines the event latch enable mode. Event latching is disabled for a_vecm_ele = 0. In this case, the vector-magnitude interrupt flag is in updated real-time and is cleared when the condition for triggering the interrupt is no longer true. The setting and clearing of the event flag is controlled by the A_VECM_CNT register's programmed debounce time. For a_vecm_ele = 1, the interrupt flag is latched in and held until the host application reads the INT_SOURCE register (0x0C).
a_vecm_initm	Control bit a_vecm_initm defines how the initial reference values (x_ref, y_ref, and z_ref) are chosen. For a_vecm_initm = 0 the function uses the current X, Y, and Z accelerometer output data at the time when the vector-magnitude function is enabled. For a_vecm_initm = 1 the function uses the data from A_VECM_INIT_X/Y/Z registers as the initial reference values.
a_vecm_updm	Control bit a_vecm_updm defines how the reference values are updated once the vector-magnitude function has been triggered. For a_vecm_updm = 0, the function updates the reference value with the current X, Y, and Z accelerometer output data values. For a_vecm_updm = 1, the function does not update the reference values when the interrupt is triggered. Instead the function continues to use the reference values that were loaded when the function was enabled. If both a_vecm_initm and a_vecm_updm are set to logic '1', the host software can manually update the reference values in real time by writing to the A_VECM_INIT_X/Y/Z registers.
a_vecm_en	The accelerometer vector-magnitude function is enabled by setting a_vecm_en = 1, and disabled by clearing this bit (default). The reference values are loaded with either the current X, Y, and Z acceleration values or the values stored in the A_VECM_INIT_X/Y/Z registers, depending on the state of the a_vecm_initm bit. Note: The vector-magnitude function will only perform correctly up to a maximum ODR of 400 Hz.

14.10.2 A_VECM_THS_MSB (address 0x60) register

Table 97. A_VECM_THS_MSB register (address 0x60) bit allocation

Bit	7	6	5	4	3	2	1	0
Symbol	a_vecm_dbcntm	-	-	a_vecm_ths[12:8]				
Reset	0	0	0	0	0	0	0	0
Access	R/W	R/W	R/W	R/W	R/W	R/W	R/W	R/W

Table 98. A_VECM_THS_MSB register (address 0x60) bit descriptions

Field	Description
a_vecm_dbcntm	Control bit a_vecm_dbcntm defines how the debounce timer is reset when the condition for triggering the interrupt is no longer true. When a_vecm_dbcntm = 0 the debounce counter is decremented by 1 when the vector-magnitude result is below the programmed threshold value. When a_vecm_dbcntm = 1 the debounce counter is cleared when the vector-magnitude result is below the programmed threshold value.
a_vecm_ths[12:8]	Five MSBs of the 13-bit unsigned A_VECM_THS value. The resolution is equal to the selected accelerometer resolution set in XYZ_DATA_CFG[fs]

14.10.3 A_VECM_THS_LSB register (address 0x61)

Table 99. A_VECM_THS_LSB register (address 0x61) bit allocation

Bit	7	6	5	4	3	2	1	0
Symbol	a_vecm_ths[7:0]							
Reset	0	0	0	0	0	0	0	0
Access	R/W	R/W	R/W	R/W	R/W	R/W	R/W	R/W

14.10.4 A_VECM_CNT register (address 0x62)

Table 100. A_VECM_CNT register (address 0x62) bit allocation

Bit	7	6	5	4	3	2	1	0
Symbol	a_vecm_cnt[7:0]							
Reset	0	0	0	0	0	0	0	0
Access	R/W	R/W	R/W	R/W	R/W	R/W	R/W	R/W

Table 101. A_VECM_CNT register (address 0x62) bit description

Field	Description
a_vecm_cnt[7:0]	Vector-magnitude function debounce count value.

The debounce timer period is determined by the ODR selected in CTRL_REG1; it is equal to the number indicated in A_VECM_CNT register times 1/ODR. For example, a value of 16 in A_VECM_CNT with an ODR setting of 400 Hz will result in a debounce period of 40 ms. Note that ODR is halved when in hybrid mode.

14.10.5 A_VECM_INITX_MSB register (address 0x63)

Table 102. A_VECM_INITX_MSB register (address 0x63) bit allocation

Bit	7	6	5	4	3	2	1	0
Symbol	-	-	a_vecm_initx [13:8]					
Reset	0	0	0	0	0	0	0	0
Access	R/W	R/W	R/W	R/W	R/W	R/W	R/W	R/W

Table 103. A_VECM_INITX_MSB register (address 0x63) bit description

Field	Description
a_vecm_initx[13:8]	Most significant 6 bits of the signed 14-bit initial X-axis value to be used as ref_x when A_VECM_CFG[a_vecm_initm] = 1. The resolution is determined by the settings made in XYZ_DATA_CFG[fs], and is equal to the accelerometer resolution.

14.10.6 A_VECM_INITX_LSB register (address 0x64)

Table 104. A_VECM_INITX_LSB register (address 0x64)

Bit	7	6	5	4	3	2	1	0
Symbol	a_vecm_initx[7:0]							
Reset	0	0	0	0	0	0	0	0
Access	R/W	R/W	R/W	R/W	R/W	R/W	R/W	R/W

Table 105. A_VECM_INITX_LSB register (address 0x64) bit description

Field	Description
a_vecm_initx[7:0]	LSB of the signed 14-bit initial X-axis value to be used as ref_x when A_VECM_CFG[a_vecm_initm] = 1. The resolution is determined by the settings made in XYZ_DATA_CFG[fs], and is equal to the accelerometer resolution.

14.10.7 A_VECM_INITY_MSB register (address 0x65)

Table 106. A_VECM_INITY_MSB register (address 0x65) bit allocation

Bit	7	6	5	4	3	2	1	0
Symbol	-	-	a_vecm_inity					
Reset	0	0	0	0	0	0	0	0
Access	R/W	R/W	R/W	R/W	R/W	R/W	R/W	R/W

Table 107. A_VECM_INITY_MSB register (address 0x65) bit description

Field	Description
a_vecm_inity[13:8]	Most significant 6 bits of the signed 14-bit initial Y-axis value to be used as ref_y when A_VECM_CFG[a_vecm_initm] = 1. The resolution is determined by the settings made in XYZ_DATA_CFG[fs], and is equal to the accelerometer resolution.

14.10.8 A_VECM_INITY_LSB register (address 0x66)

Table 108. A_VECM_INITY_LSB register (address 0x66) bit allocation

Bit	7	6	5	4	3	2	1	0
Symbol	a_vecm_inity[7:0]							
Reset	0	0	0	0	0	0	0	0
Access	R/W	R/W	R/W	R/W	R/W	R/W	R/W	R/W

Table 109. A_VECM_INITY_LSB register (address 0x66) bit description

Field	Description
a_vecm_inity[7:0]	LSB of the signed 14-bit initial Y-axis value to be used as ref_y when A_VECM_CFG[a_vecm_initm] = 1. The resolution is determined by the settings made in XYZ_DATA_CFG[fs], and is equal to the accelerometer resolution.

14.10.9 A_VECM_INITZ_MSB register (address 0x67)

Table 110. A_VECM_INITZ_MSB register (address 0x67) bit allocation

Bit	7	6	5	4	3	2	1	0
Symbol	-	-	a_vecm_initz[13:8]					
Reset	0	0	0	0	0	0	0	0
Access	R/W	R/W	R/W	R/W	R/W	R/W	R/W	R/W

Table 111. A_VECM_INITZ_MSB register (address 0x67) bit description

Field	Description
a_vecm_initz[13:8]	Most significant 6 bits of the signed 14-bit initial Z-axis value to be used as ref_z when A_VECM_CFG[a_vecm_initm] = 1. The resolution is determined by the settings made in XYZ_DATA_CFG[fs], and is equal to the accelerometer resolution.

14.10.10 A_VECM_INITZ_LSB register (address 0x68)

Table 112. A_VECM_INITZ_LSB register (address 0x68) bit allocation

Bit	7	6	5	4	3	2	1	0
Symbol	a_vecm_initz[7:0]							
Reset	0	0	0	0	0	0	0	0
Access	R/W	R/W	R/W	R/W	R/W	R/W	R/W	R/W

Table 113. A_VECM_INITZ_LSB register (address 0x68) bit description

Field	Description
a_vecm_initz[7:0]	LSB of the signed 14-bit initial Z-axis value to be used as ref_z when A_VECM_CFG[a_vecm_initm] = 1. The resolution is determined by the settings made in XYZ_DATA_CFG[fs], and is equal to the accelerometer resolution.

14.11 Transient (AC) acceleration detection registers

The transient detection function is similar to the freefall/motion detection function with the exception that a high-pass filter can be used to eliminate the DC offset from the acceleration data. There is an option to disable the high-pass filter, which causes the transient detection function to work in a similar manner to the motion detection function.

The transient detection function can be configured to signal an interrupt when the high-pass filtered acceleration delta values for any of the enabled axes exceeds the threshold programmed in TRANSIENT_THS for the debounce time programmed in TRANSIENT_COUNT. For more information on how to use and configure the transient detection function, refer to NXP application note AN4461.

14.11.1 TRANSIENT_CFG register (address 0x1D)

Table 114. TRANSIENT_CFG register (address 0x1D) bit allocation

Bit	7	6	5	4	3	2	1	0
Symbol	-	-	-	tran_ele	tran_zefe	tran_yefe	tran_xefe	tran_hpf_byp
Reset	0	0	0	0	0	0	0	0
Access	R/W	R/W	R/W	R/W	R/W	R/W	R/W	R/W

Table 115. TRANSIENT_CFG register (address 0x1D) bit descriptions

Field	Description
tran_ele	Transient event flag latch enable. 0 – Event flag latch disabled: the transient interrupt flag reflects the real-time status of the function. 1 – Event flag latch enabled: the transient interrupt event flag is latched and a read of the TRANSIENT_SRC register is required to clear the event flag.
tran_zefe	Z-axis transient event flag enable. 0 – Z-axis event detection disabled 1 – Z-axis event detection enabled. Raise event flag on Z-axis acceleration value greater than threshold.
tran_yefe	Y-axis transient event flag enable. 0 – Y-axis event detection disabled 1 – Y-axis event detection enabled. Raise event flag on Y-axis acceleration value greater than threshold.
tran_xefe	X-axis transient event flag enable. 0 – X-axis event detection disabled 1 – X-axis event detection enabled. Raise event flag on X-axis acceleration value greater than threshold.
tran_hpf_byp	Transient function high-pass filter bypass. 0 – High-pass filter is applied to accelerometer data input to the transient function. 1 – High-pass filter is not applied to accelerometer data input to the transient function.

14.11.2 TRANSIENT_SRC register (address 0x1E)

Transient event flag source register. This register provides the event status of the enabled axes and polarity (directional) information.

Table 116. TRANSIENT_SRC register (address 0x1E) bit allocation

Bit	7	6	5	4	3	2	1	0
Symbol	-	tran_ea	tran_zef	tran_zpol	tran_yef	tran_ypol	tran_xef	trans_xpol
Reset	0	0	0	0	0	0	0	0
Access	R	R	R	R	R	R	R	R

Table 117. TRANSIENT_SRC register (address 0x1E) bit descriptions

Field	Description
tran_ea	Transient event active flag. 0 – No transient event active flag has been asserted. 1 – One or more transient event active flags has been asserted.
tran_zef	Z-axis transient event active flag. 0 – Z-axis event flag is not active. 1 – Z-axis event flag is active; Z-axis acceleration has exceeded the programmed threshold for the debounce time specified in TRANS_COUNT.
tran_zpol	Z-axis event flag polarity. 0 – Z-axis event was above positive threshold value. 1 – Z-axis event was below negative threshold value.
tran_yef	Y-axis transient event active flag. 0 – Y-axis event flag is not active. 1 – Y-axis event flag is active; Y-axis acceleration has exceeded the programmed threshold for the debounce time specified in TRANS_COUNT.
tran_ypol	Y-axis event flag polarity. 0 – Y-axis event was above positive threshold value. 1 – Y-axis event was below negative threshold value.
tran_xef	X-axis transient event active flag. 0 – X-axis event flag is not active. 1 – X-axis event flag is active; X-axis acceleration has exceeded the programmed threshold for the debounce time specified in TRANS_COUNT.
tran_xpol	X-axis event flag polarity. 0 – X-axis event was above positive threshold value. 1 – X-axis event was below negative threshold value.

When TRANSIENT_CFG[tran_ele] = 1, the TRANSIENT_SRC event flag(s) and polarity bits are latched when the interrupt event is triggered, allowing the host application to determine which event flag(s) originally triggered the interrupt. When TRANSIENT_CFG[tran_ele] = 0, events which occur after the event that originally triggered the interrupt will update the flag and polarity bits, but once set, the flags can only be cleared by reading the TRANSIENT_SRC register.

14.11.3 TRANSIENT_THS register (address 0x1F)

The TRANSIENT_THS register determines the debounce counter behavior and also sets the transient event detection threshold. It is possible to use A_FFMT_THS_X/Y/Z MSB and LSB registers to set transient acceleration thresholds for individual axes using the a_ffmt_trans_ths_en bit in A_FFMT_THS_Y_MSB register. For a_ffmt_trans_ths_en = 1, register 0x1F[6:0] is used as the 7-bit, X-axis transient threshold, registers 0x75[0] and 0x76[7:2] as the 7-bit, Y-axis threshold and registers 0x77[0] and 0x78[7:2] as the 7-bit, Z-axis threshold.

Table 118. TRANSIENT_THS register (address 0x1F) bit allocation

Bit	7	6	5	4	3	2	1	0
Symbol	tr_dbcntm	tr_ths[6:0]						
Reset	0	0	0	0	0	0	0	0
Access	R/W	R/W	R/W	R/W	R/W	R/W	R/W	R/W

Table 119. TRANSIENT_THS register (address 0x1F) descriptions

Field	Description
tr_dbcntm	Debounce counter mode selection. 0 – Decrements debounce counter when the transient event condition is not true during the current ODR period. 1 – Clears debounce counter when the transient event condition is not true during the current ODR period.
tr_ths[6:0]	Transient event threshold. This register has a resolution of 63 mg/LSB regardless of the full-scale range setting made in XYZ_DATA_CFG[fs]. If CTRL_REG1[noise] = 1, the maximum acceleration measurement range is ±4 g.

The tr_ths[6:0] value is a 7-bit unsigned number, with a fixed resolution of 63 mg/LSB corresponding to a ±8 g measurement range. The resolution does not change with the full-scale range setting made in XYZ_DATA_CFG[fs]. If CTRL_REG1[noise] = 1, the measurement range is fixed at ±4 g, regardless of the settings made in XYZ_DATA_CFG.

14.11.4 TRANSIENT_COUNT register (address 0x20)

The TRANSIENT_COUNT register sets the minimum number of debounce counts needed to trigger the transient event interrupt flag when the measured acceleration value exceeds the threshold set in TRANSIENT_THS for any of the enabled axes.

Table 120. TRANSIENT_COUNT register (address 0x20) bit allocation

Bit	7	6	5	4	3	2	1	0
Symbol	tr_count[7:0]							
Reset	0	0	0	0	0	0	0	0
Access	R/W	R/W	R/W	R/W	R/W	R/W	R/W	R/W

Table 121. TRANSIENT_COUNT register (address 0x20) bit description

Field	Description
tr_count[7:0]	Transient function debounce count value.

The time step for the transient detection debounce counter is set by the value of the system ODR and power mode as shown in [Table 122](#). When the device is operated in hybrid mode, the effective ODR is half of what is selected in CTRL_REG1, which also doubles the time-step values shown in [Table 122](#).

Table 122. TRANSIENT_COUNT relationship with the ODR

ODR (Hz)	Max time range (s)				Time step (ms)			
	Normal	LPLN	High resolution	Low power	Normal	LPLN	High resolution	LP
800	0.319	0.319	0.319	0.319	1.25	1.25	1.25	1.25
400	0.638	0.638	0.638	0.638	2.5	2.5	2.5	2.5
200	1.28	1.28	0.638	1.28	5	5	2.5	5

Table 122. TRANSIENT_COUNT relationship with the ODR - *continued*

ODR (Hz)	Max time range (s)				Time step (ms)			
	Normal	LPLN	High resolution	Low power	Normal	LPLN	High resolution	LP
100	2.55	2.55	0.638	2.55	10	10	2.5	10
50	5.1	5.1	0.638	5.1	20	20	2.5	20
12.5	5.1	20.4	0.638	20.4	20	80	2.5	80
6.25	5.1	20.4	0.638	40.8	20	80	2.5	160
1.56	5.1	20.4	0.638	40.8	20	80	2.5	160

An ODR of 100 Hz and a TRANSIENT_COUNT value of 15, when accelerometer OSR is set to normal using CTRL_REG2, would result in minimum debounce response time of 150 ms. When the device is operated in hybrid mode, these settings would result in an effective debounce time of 300 ms.

14.12 Pulse detection registers

14.12.1 PULSE_CFG register (address 0x21)

This register configures the pulse event detection function.

Table 123. PULSE_CFG register (address 0x21) bit allocation

Bit	7	6	5	4	3	2	1	0
Symbol	pls_dpa	pls_ele	pls_zdpufe	pls_zspufe	pls_ydpufe	pls_yspufe	pls_xdpufe	pls_xspufe
Reset	0	0	0	0	0	0	0	0
Access	R/W	R/W	R/W	R/W	R/W	R/W	R/W	R/W

Table 124. PULSE_CFG register (address 0x21) bit descriptions

Field	Description
pls_dpa	Double-pulse abort. 0 – Double-pulse detection is not aborted if the start of a pulse is detected during the time period specified by the PULSE_LTCY register. 1 – Setting the pls_dpa bit momentarily suspends the double-tap detection if the start of a pulse is detected during the time period specified by the PULSE_LTCY register and the pulse ends before the end of the time period specified by the PULSE_LTCY register.
pls_ele	Pulse event flag latch enable. When enabled, a read of the PULSE_SRC register is needed to clear the event flag. 0 – Event flag latch disabled 1 – Event flag latch enabled
pls_zdpufe	Event flag enable on double-pulse event on Z-axis. 0 – Event detection disabled 1 – Raise event flag on detection of double-pulse event on Z-axis
pls_zspufe	Event flag enable on single-pulse event on Z-axis. 0 – Event detection disabled 1 – Raise event flag on detection of single-pulse event on Z-axis
pls_ydpufe	Event flag enable on double-pulse event on Y-axis. 0 – Event detection disabled 1 – Raise event flag on detection of double-pulse event on Y-axis

Table 124. PULSE_CFG register (address 0x21) bit descriptions - *continued*

Field	Description
pls_yspefe	Event flag enable on single-pulse event on Y-axis. 0 – Event detection disabled 1 – Raise event flag on detection of single-pulse event on Z-axis.
pls_xdpefe	Event flag enable on double-pulse event on X-axis. 0 – Event detection disabled 1 – Raise event flag on detection of double-pulse event on X-axis.
pls_xspefe	Event flag enable on single-pulse event on X-axis. 0 – Event detection disabled 1 – Raise event flag on detection of single-pulse event on X-axis.

14.12.2 PULSE_SRC register (address 0x22)

This register indicates the status bits for the pulse detection function.

Table 125. PULSE_SRC register (address 0x22) bit allocation

Bit	7	6	5	4	3	2	1	0
Symbol	pls_src_ea	pls_src_axz	pls_src_axy	pls_src_axx	pls_src_dpe	pls_src_polz	pls_src_poly	pls_src_polx
Reset	0	0	0	0	0	0	0	0
Access	R	R	R	R	R	R	R	R

Table 126. PULSE_SRC register (address 0x22) bit descriptions

Field	Description
pls_src_ea	Event active flag. 0 – No interrupt has been generated 1 – One or more interrupt events have been generated
pls_src_axz	Z-axis event flag. 0 – No interrupt 1 – Z-axis event has occurred
pls_src_axy	Y-axis event flag. 0 – No interrupt 1 – Y-axis event has occurred
pls_src_axx	X-axis event flag. 0 – No interrupt 1 – X-axis event has occurred.
pls_src_dpe	Double pulse on first event. 0 – Single-pulse event triggered interrupt 1 – Double-pulse event triggered interrupt

Table 126. PULSE_SRC register (address 0x22) bit descriptions - *continued*

Field	Description
pls_src_polz	Pulse polarity of Z-axis event. 0 – Pulse event that triggered interrupt was positive. 1 – Pulse event that triggered interrupt was negative.
pls_src_poly	Pulse polarity of Y-axis event. 0 – Pulse event that triggered interrupt was positive. 1 – Pulse event that triggered interrupt was negative.
pls_src_polx	Pulse polarity of X-axis event. 0 – Pulse event that triggered interrupt was positive. 1 – Pulse event that triggered interrupt was negative.

14.12.3 PULSE_THSX register (address 0x23)

Table 127. PULSE_THSX register (address 0x23) bit allocation

Bit	7	6	5	4	3	2	1	0
Symbol	-	pls_thsx[6:0]						
Reset	0	0	0	0	0	0	0	0
Access	R/W	R/W	R/W	R/W	R/W	R/W	R/W	R/W

Table 128. PULSE_THSX register (address 0x23) bit description

Field	Description
pls_thsx[6:0]	Pulse threshold for X-axis.

The PULSE_THSX, PULSE_THSY and PULSE_THSZ registers define the thresholds used by the system to start the pulse-event detection procedure. Threshold values for each axis are unsigned 7-bit numbers with a fixed resolution of 0.063 g/LSB, corresponding to an 8 g acceleration full-scale range. The full-scale range is fixed at 8 g for the pulse detection function, regardless of the settings made in XYZ_DATA_CFG[fs].

14.12.4 PULSE_THSY register (address 0x24)

Table 129. PULSE_THSY register (address 0x24) bit allocation

Bit	7	6	5	4	3	2	1	0
Symbol	-	pls_thsy[6:0]						
Reset	0	0	0	0	0	0	0	0
Access	R/W	R/W	R/W	R/W	R/W	R/W	R/W	R/W

Table 130. PULSE_THSY register (address 0x24) bit description

Field	Description
pls_thsy[6:0]	Pulse threshold for Y-axis.

14.12.5 PULSE_THSZ register (address 0x25)

Table 131. PULSE_THSZ register (address 0x25) bit allocation

Bit	7	6	5	4	3	2	1	0
Symbol	-	pls_thsz[6:0]						
Reset	0	0	0	0	0	0	0	0
Access	R/W	R/W	R/W	R/W	R/W	R/W	R/W	R/W

Table 132. PULSE_THSZ register (address 0x24) bit description

Field	Description
pls_thsz[6:0]	Pulse threshold for Z-axis.

14.12.6 PULSE_TMLT register (address 0x26)

Table 133. PULSE_TMLT register (address 0x26) bit allocation

Bit	7	6	5	4	3	2	1	0
Symbol	pls_tmlt[7:0]							
Reset	0	0	0	0	0	0	0	0
Access	R/W	R/W	R/W	R/W	R/W	R/W	R/W	R/W

Table 134. PULSE_TMLT register (address 0x26) bit description

Field	Description
pls_tmlt[7:0]	pls_tmlt[7:0] defines the maximum time interval that can elapse between the start of the acceleration on the selected channel exceeding the specified threshold and the end when the channel acceleration goes back below the specified threshold.

Minimum time step for the pulse-time limit is defined in [Table 135](#) and [Table 136](#).
 Maximum time for a given ODR is “Minimum time step x 255”.

Table 135. Time step for PULSE_TMLT with HP_FILTER_CUTOFF[pls_hpf_en] = 1

ODR (Hz)	Max time range (s)				Time step (ms)			
	Normal	LPLN	High resolution	Low power	Normal	LPLN	High resolution	LP
800	0.319	0.319	0.319	0.319	1.25	1.25	1.25	1.25
400	0.638	0.638	0.638	0.638	2.5	2.5	2.5	2.5
200	1.28	1.28	0.638	1.28	5	5	2.5	5
100	2.55	2.55	0.638	2.55	10	10	2.5	10
50	5.1	5.1	0.638	5.1	20	20	2.5	20
12.5	5.1	20.4	0.638	20.4	20	80	2.5	80
6.25	5.1	20.4	0.638	40.8	20	80	2.5	160
1.56	5.1	20.4	0.638	40.8	20	80	2.5	160

Table 136. Time step for PULSE_TMLT with HP_FILTER_CUTOFF[pls_hpf_en] = 0

ODR (Hz)	Max time range (s)				Time step (ms)			
	Normal	LPLN	High resolution	Low power	Normal	LPLN	High resolution	LP
800	0.159	0.159	0.159	0.159	0.625	0.625	0.625	0.625
400	0.159	0.159	0.159	0.319	0.625	0.625	0.625	1.25
200	0.319	0.319	0.159	0.638	1.25	1.25	0.625	2.5
100	0.638	0.638	0.159	1.28	2.5	2.5	0.625	5
50	1.28	1.28	0.159	2.55	5	5	0.625	10
12.5	1.28	5.1	0.159	10.2	5	20	0.625	40
6.25	1.28	5.1	0.159	10.2	5	20	0.625	40
1.56	1.28	5.1	0.159	10.2	5	20	0.625	40

Therefore an ODR setting of 400 Hz, when accelerometer OSR is set to normal using CTRL_REG2, would result in a maximum pulse-time limit of $(0.625 \text{ ms} * 255) = 159 \text{ ms}$.

14.12.7 PULSE_LTCY register (address 0x27)

Table 137. PULSE_LTCY register (address 0x27) bit allocation

Bit	7	6	5	4	3	2	1	0
Symbol	pls_ltcy[7:0]							
Reset	0	0	0	0	0	0	0	0
Access	R/W	R/W	R/W	R/W	R/W	R/W	R/W	R/W

Table 138. PULSE_LTCY register (address 0x27) bit description

Field	Description
pls_ltcy[7:0]	pls_ltcy[7:0] defines the time interval that starts after the first pulse detection where the pulse-detection function ignores the start of a new pulse.

Minimum time step for the pulse latency is defined in [Table 139](#) and [Table 140](#). Maximum time is (time step @ ODR and power mode) x 255.

Table 139. Time step for PULSE_LTCY with HP_FILTER_CUTOFF[pls_hpf_en] = 1

ODR (Hz)	Max time range (s)				Time step (ms)			
	Normal	LPLN	High resolution	Low power	Normal	LPLN	High resolution	LP
800	0.638	0.638	0.638	0.638	2.5	2.5	2.5	2.5
400	1.276	1.276	1.276	1.276	5	5	5	5
200	2.56	2.56	1.276	2.56	10	10	5	10
100	5.1	5.1	1.276	5.1	20	20	5	20
50	10.2	10.2	1.276	10.2	40	40	5	40
12.5	10.2	40.8	1.276	40.8	40	160	5	160
6.25	10.2	40.8	1.276	81.6	40	160	5	320
1.56	10.2	40.8	1.276	81.6	40	160	5	320

Table 140. Time step for PULSE_LTCY with HP_FILTER_CUTOFF[pls_hpf_en] = 0

ODR (Hz)	Max time range (s)				Time step (ms)			
	Normal	LPLN	High resolution	Low power	Normal	LPLN	High resolution	LP
800	0.318	0.318	0.318	0.318	1.25	1.25	1.25	1.25
400	0.318	0.318	0.318	0.638	1.25	1.25	1.25	2.5
200	0.638	0.638	0.318	1.276	2.5	2.5	1.25	5
100	1.276	1.276	0.318	2.56	5	5	1.25	10
50	2.56	2.56	0.318	5.1	10	10	1.25	20
12.5	2.56	10.2	0.318	20.4	10	40	1.25	80
6.25	2.56	10.2	0.318	20.4	10	40	1.25	80
1.56	2.56	10.2	0.318	20.4	10	40	1.25	80

14.12.8 PULSE_WIND register (address 0x28)

Table 141. PULSE_WIND register (address 0x28) bit allocation

Bit	7	6	5	4	3	2	1	0
Symbol	pls_wind[7:0]							
Reset	0	0	0	0	0	0	0	0
Access	R/W	R/W	R/W	R/W	R/W	R/W	R/W	R/W

Table 142. PULSE_WIND register (address 0x28) bit description

Field	Description
pls_wind[7:0]	pls_wind[7:0] defines the maximum interval of time that can elapse after the end of the latency interval in which the start of the second pulse event must be detected provided the device has been configured for double pulse detection. The detected second pulse width must be shorter than the time limit constraint specified by the PULSE_TMLT register, but the end of the double pulse need not finish within the time specified by the PULSE_WIND register.

The time step for the pulse-window counter varies with the selected ODR and power modes as defined in [Table 143](#) and [Table 144](#). The maximum time value is equal to (time step @ ODR and power mode) * 255. Please note that when the device is operated in hybrid mode, the effective ODR is half of what is selected in CTRL_REG1, which will double the time-step value from what is shown in [Table 143](#) and [Table 144](#).

Table 143. Time step for PULSE_WIND with HP_FILTER_CUTOFF[pls_hpf_en] = 1

ODR (Hz)	Max time range (s)				Time step (ms)			
	Normal	LPLN	High resolution	Low power	Normal	LPLN	High resolution	LP
800	0.638	0.638	0.638	0.638	2.5	2.5	2.5	2.5
400	1.276	1.276	1.276	1.276	5	5	5	5
200	2.56	2.56	1.276	2.56	10	10	5	10
100	5.1	5.1	1.276	5.1	20	20	5	20
50	10.2	10.2	1.276	10.2	40	40	5	40
12.5	10.2	40.8	1.276	40.8	40	160	5	160
6.25	10.2	40.8	1.276	81.6	40	160	5	320
1.56	10.2	40.8	1.276	81.6	40	160	5	320

Table 144. Time step for PULSE_WIND with HP_FILTER_CUTOFF[pls_hpf_en] = 0

ODR (Hz)	Max time range (s)				Time step (ms)			
	Normal	LPLN	High resolution	Low power	Normal	LPLN	High resolution	LP
800	0.318	0.318	0.318	0.318	1.25	1.25	1.25	1.25
400	0.318	0.318	0.318	0.638	1.25	1.25	1.25	2.5
200	0.638	0.638	0.318	1.276	2.5	2.5	1.25	5
100	1.276	1.276	0.318	2.56	5	5	1.25	10
50	2.56	2.56	0.318	5.1	10	10	1.25	20
12.5	2.56	10.2	0.318	20.4	10	40	1.25	80
6.25	2.56	10.2	0.318	20.4	10	40	1.25	80
1.56	2.56	10.2	0.318	20.4	10	40	1.25	80

14.13 Accelerometer offset correction registers

The 8-bit 2's complement offset correction registers are used to remove the sensor zero-g offset on the X, Y, and Z axes after device board mount. The resolution of the offset registers is 2 mg per LSB, with an effective offset adjustment range of -256 mg to +254 mg for each axis. The acceleration vectors represented in these registers will be added to the acceleration vectors acquired by the ASIC from the transducer prior to being written to the output data registers (registers 0x01 through 0x06). For example, to correct for an offset of 60 mg, a value representing -60 mg ($= -60 \text{ mg} / 2 \text{ mg/LSB} = -30 \text{ LSB}$), which is 0xE2 in 8-bit 2's complement representation, should be written to the offset register.

For more information on how to calibrate the zero-g offset, please refer to NXP application note AN4069.

NOTE

Accelerometer offset registers can only be modified when the device is in standby mode (See ["M_CTRL_REG1 register \(address 0x5B\)"](#) on [page 97.](#))

14.13.1 OFF_X register (address 0x2F)

Table 145. OFF_X register (address 0x2F) bit allocation

Bit	7	6	5	4	3	2	1	0
Symbol	off_x[7:0]							
Reset	0	0	0	0	0	0	0	0
Access	R/W	R/W	R/W	R/W	R/W	R/W	R/W	R/W

Table 146. OFF_X register (address 0x2F) bit description

Field	Description
off_x[7:0]	X-axis offset correction value expressed as an 8-bit 2's complement number.

14.13.2 OFF_Y register (address 0x30)

Table 147. OFF_Y register (address 0x30) bit allocation

Bit	7	6	5	4	3	2	1	0
Symbol	off_y[7:0]							
Reset	0	0	0	0	0	0	0	0
Access	R/W	R/W	R/W	R/W	R/W	R/W	R/W	R/W

Table 148. OFF_Y register (address 0x30) bit description

Field	Description
off_y[7:0]	Y-axis offset correction value expressed as an 8-bit 2's complement number.

14.13.3 OFF_Z register (address 0x31)

Table 149. OFF_Z register (address 0x31) bit allocation

Bit	7	6	5	4	3	2	1	0
Symbol	off_z[7:0]							
Reset	0	0	0	0	0	0	0	0
Access	R/W	R/W	R/W	R/W	R/W	R/W	R/W	R/W

Table 150. OFF_Z register (address 0x31) bit description

Field	Description
off_z[7:0]	Z-axis offset correction value expressed as an 8-bit 2's complement number.

14.14 Magnetometer data registers

14.14.1 M_DR_STATUS register (address 0x32)

Magnetic data-ready status register.

This register indicates the real-time status information of the X, Y, and Z magnetic sample data.

Table 151. M_DR_STATUS register (address 0x32) bit allocation

Bit	7	6	5	4	3	2	1	0
Symbol	xyzow	zow	yow	xow	xyzdr	zdr	ydr	xdr
Reset	0	0	0	0	0	0	0	0
Access	R	R	R	R	R	R	R	R

Table 152. M_DR_STATUS register (address 0x32) bit descriptions

Field	Description
zyxow	zyxow is set to one whenever new magnetic data is acquired before completing the retrieval of the previous data set. This event occurs when the content of at least one magnetometer output data register (that is, M_OUT_X/Y/Z) has been overwritten. zyxow is cleared when the most significant bytes of the magnetometer data (M_OUT_X_MSB, M_OUT_Y_MSB, and M_OUT_Z_MSB) are read. X, Y, and Z-axis data overwrite: 0 – No data overwrite has occurred 1 – Previous X, Y, and Z-magnetic data was overwritten by new X, Y, and Z data before it was completely read
zow	zow is set to 1 whenever a new Z-axis acquisition is completed before the retrieval of the previous data. When this occurs the previous data is overwritten. zow is cleared anytime the M_OUT_Z_MSB register is read. Z-axis data overwrite: 0 – No data overwrite has occurred 1 – Previous Z-axis magnetic data was overwritten by new Z-axis data before it was read
yow	yow is set to 1 whenever a new Y-axis acquisition is completed before the retrieval of the previous data. When this occurs the previous data is overwritten. yow is cleared anytime M_OUT_Y_MSB register is read. Y-axis data overwrite: 0 – No data overwrite has occurred 1 – Previous Y-axis magnetic data was overwritten by new Y-axis data before it was read
xow	xow is set to 1 whenever a new X-axis acquisition is completed before the retrieval of the previous data. When this occurs the previous data is overwritten. xow is cleared anytime the M_OUT_X_MSB register is read. X-axis data overwrite: 0 – No data overwrite has occurred 1 – Previous X-axis magnetic data was overwritten by new X-axis data before it was read
zyxdr	zyxdr signals that a new acquisition for the X, Y, and Z axes magnetic data is available. zyxdr is cleared when the most significant bytes of the magnetometer data (M_OUT_X_MSB, M_OUT_Y_MSB, and M_OUT_Z_MSB) are read. X, Y, and Z new data available: 0 – No new set of X, Y, and Z magnetic data is available 1 – A new set of X, Y, and Z magnetic data is available
zdr	zdr is set to 1 whenever a new Z-axis data acquisition is completed. zdr is cleared anytime the M_OUT_Z_MSB register is read. Z-axis new data available: 0 – No new Z-axis magnetic data is available 1 – New Z-axis magnetic data is available
ydr	ydr is set to 1 whenever a new Y-axis data acquisition is completed. ydr is cleared anytime the M_OUT_Y_MSB register is read. Y-axis new data available: 0 – No new Y-axis magnetic data is available 1 – New Y-axis magnetic data is available
xdr	xdr is set to 1 whenever a new X-axis data acquisition is completed. xdr is cleared anytime the M_OUT_X_MSB register is read. X-axis new data available: 0 – No new X-axis magnetic data is available. 1 – New X-axis magnetic data is available

14.14.2 M_OUT_X_MSB, M_OUT_X_LSB, M_OUT_Y_MSB, M_OUT_Y_LSB, M_OUT_Z_MSB, M_OUT_Z_LSB registers (addresses 0x33 to 0x38)

X-axis, Y-axis, and Z-axis 16-bit magnetic output data expressed as 2's complement numbers, with a resolution of 0.1 μ T/LSB.

Table 153. M_OUT_X_MSB register (address 0x33) bit allocation

Bit	7	6	5	4	3	2	1	0
Symbol	m_out_x[15:8]							
Reset	0	0	0	0	0	0	0	0
Access	R	R	R	R	R	R	R	R

Table 154. M_OUT_X_LSB register (address 0x34) bit allocation

Bit	7	6	5	4	3	2	1	0
Symbol	m_out_x[7:0]							
Reset	0	0	0	0	0	0	0	0
Access	R	R	R	R	R	R	R	R

Table 155. M_OUT_Y_MSB register (address 0x35) bit allocation

Bit	7	6	5	4	3	2	1	0
Symbol	m_out_y[15:8]							
Reset	0	0	0	0	0	0	0	0
Access	R	R	R	R	R	R	R	R

Table 156. M_OUT_Y_LSB register (address 0x36) bit allocation

Bit	7	6	5	4	3	2	1	0
Symbol	m_out_y[7:0]							
Reset	0	0	0	0	0	0	0	0
Access	R	R	R	R	R	R	R	R

Table 157. M_OUT_Z_MSB register (address 0x37) bit allocation

Bit	7	6	5	4	3	2	1	0
Symbol	m_out_z[15:8]							
Reset	0	0	0	0	0	0	0	0
Access	R	R	R	R	R	R	R	R

Table 158. M_OUT_Z_LSB register (address 0x38) bit allocation

Bit	7	6	5	4	3	2	1	0
Symbol	m_out_z[7:0]							
Reset	0	0	0	0	0	0	0	0
Access	R	R	R	R	R	R	R	R

14.14.3 CMP_X_MSB (address 0x39), CMP_X_LSB, CMP_Y_MSB, CMP_Y_LSB, CMP_Z_MSB, CMP_Z_LSB (addresses 0x3A to 0x3E) registers

These registers contain the 2’s complement 14-bit decimated acceleration values, and are time aligned with the magnetometer sample data. The decimation is controlled by the ODR (CTRL_REG1 dr[2:0]) and the magnetometer OSR (M_CTRL_REG1 m_os[2:0]) settings. These registers allow the host application to acquire a complete set of time-aligned magnetic and acceleration data with the same oversampling ratio applied to each axis. Note that unlike the acceleration data available in the OUT_X/Y/Z registers located at addresses 0x1 through 0x6, the data in the CMP_X/Y/Z registers is right justified.

Table 159. CMP_X_MSB register (address 0x39) bit allocation

Bit	7	6	5	4	3	2	1	0
Symbol	-	-	cmp_x[13:8]					
Reset	0	0	0	0	0	0	0	0
Access	R	R	R	R	R	R	R	R

Table 160. CMP_X_LSB register (address 0x3A) bit allocation

Bit	7	6	5	4	3	2	1	0
Symbol	cmp_x[7:0]							
Reset	0	0	0	0	0	0	0	0
Access	R	R	R	R	R	R	R	R

Table 161. CMP_Y_MSB register (address 0x3B) bit allocation

Bit	7	6	5	4	3	2	1	0
Symbol	-	-	cmp_y[13:8]					
Reset	0	0	0	0	0	0	0	0
Access	R	R	R	R	R	R	R	R

Table 162. CMP_Y_LSB register (address 0x3C) bit allocation

Bit	7	6	5	4	3	2	1	0
Symbol	cmp_y[7:0]							
Reset	0	0	0	0	0	0	0	0
Access	R	R	R	R	R	R	R	R

Table 163. CMP_Z_MSB register (address 0x3D) bit allocation

Bit	7	6	5	4	3	2	1	0
Symbol	-	-	cmp_z[13:8]					
Reset	0	0	0	0	0	0	0	0
Access	R	R	R	R	R	R	R	R

Table 164. CMP_Z_LSB register (address 0x3E) bit allocation

Bit	7	6	5	4	3	2	1	0
Symbol	cmp_z[7:0]							
Reset	0	0	0	0	0	0	0	0
Access	R	R	R	R	R	R	R	R

14.14.4 MAX_X_MSB, MAX_X_LSB, MAX_Y_MSB, MAX_Y_LSB, MAX_Z_MSB (addresses 0x45 to 0x49), MAX_Z_LSB (address 0x4A) registers

The magnetometer MAX_X/Y/Z registers are 16-bit 2's complement format with a resolution of 0.1 μ T/LSB. The registers are read/write and along with the MIN_X/Y/Z registers are used to calculate the magnetic offset for each axis using the equation $(MAX_X/Y/Z + MIN_X/Y/Z) / 2$ when M_CTRL_REG2[maxmin_dis] = 0 (default).

When M_CTRL_REG1[m_acal] = 1 (default 0), the MAG_OFF_X/Y/Z registers are automatically updated with the calculated offset values at the end of every measurement cycle (ODR period).

On a POR, or after setting M_CTRL_REG2[maxmin_rst] = 1, the MAX_X/Y/Z registers are loaded with the hex value 0x8000 (negative full scale).

The host application may write to the MAX_X/Y/Z registers to change the currently used maximum values for each axis, however, when M_CTRL_REG1[maxmin_dis] = 0 (default), the system will overwrite these values when it updates the MAX_X/Y/Z registers at the end of the next measurement cycle (ODR period).

Table 165. MAX_X_MSB register (address 0x45) bit allocation

Bit	7	6	5	4	3	2	1	0
Symbol	max_x[15:8]							
Reset	0	0	0	0	0	0	0	0
Access	R	R	R	R	R	R	R	R

Table 166. MAX_X_LSB register (address 0x46) bit allocation

Bit	7	6	5	4	3	2	1	0
Symbol	max_x[7:0]							
Reset	0	0	0	0	0	0	0	0
Access	R	R	R	R	R	R	R	R

Table 167. MAX_Y_MSB register (address 0x47) bit allocation

Bit	7	6	5	4	3	2	1	0
Symbol	max_y[15:8]							
Reset	0	0	0	0	0	0	0	0
Access	R	R	R	R	R	R	R	R

Table 168. MAX_Y_LSB register (address 0x48) bit allocation

Bit	7	6	5	4	3	2	1	0
Symbol	max_y[7:0]							
Reset	0	0	0	0	0	0	0	0
Access	R	R	R	R	R	R	R	R

Table 169. MAX_Z_MSB register (address 0x49) bit allocation

Bit	7	6	5	4	3	2	1	0
Symbol	max_z[15:8]							
Reset	0	0	0	0	0	0	0	0
Access	R	R	R	R	R	R	R	R

Table 170. MAX_Z_LSB register (address 0x4A) bit allocation

Bit	7	6	5	4	3	2	1	0
Symbol	max_z[7:0]							
Reset	0	0	0	0	0	0	0	0
Access	R	R	R	R	R	R	R	R

14.14.5 MIN_X_MSB, MIN_X_LSB, MIN_Y_MSB, MIN_Y_LSB, MIN_Z_MSB (addresses 0x4B to 0x4F), MIN_Z_LSB (address 0x50) registers

The magnetometer MIN_X/Y/Z registers are 16-bit, 2's complement format with a resolution of 0.1 μ T/LSB. The registers are read/write and along with the MAX_X/Y/Z registers are used to calculate the magnetic offset for each axis using the equation $(MAX_X/Y/Z + MIN_X/Y/Z) / 2$ when M_CTRL_REG2[maxmin_dis] = 0 (default).

When M_CTRL_REG1[m_acal] = 1 (default 0), the MAG_OFF_X/Y/Z registers are automatically updated with the calculated offset values at the end of every measurement cycle (ODR period).

On a POR, or after setting M_CTRL_REG2[maxmin_rst] = 1, the MIN_X/Y/Z registers are loaded with the hex value 0x7FFF (positive full scale). The host application may write to the MIN_X/Y/Z registers to change the currently used minimum values for each axis, however, when M_CTRL_REG1[maxmin_dis] = 0 (default), the system will overwrite these values when it updates the MIN_X/Y/Z registers at the end of the next measurement cycle (ODR period).

Table 171. MIN_X_MSB register (address 0x4B) bit allocation

Bit	7	6	5	4	3	2	1	0
Symbol	min_x[15:8]							
Reset	0	0	0	0	0	0	0	0
Access	R	R	R	R	R	R	R	R

Table 172. MIN_X_LSB register (address 0x4C) bit allocation

Bit	7	6	5	4	3	2	1	0
Symbol	min_x[7:0]							
Reset	0	0	0	0	0	0	0	0
Access	R	R	R	R	R	R	R	R

Table 173. MIN_Y_MSB register (address 0x4D) bit allocation

Bit	7	6	5	4	3	2	1	0
Symbol	min_y[15:8]							
Reset	0	0	0	0	0	0	0	0
Access	R	R	R	R	R	R	R	R

Table 174. MIN_Y_LSB register (address 0x4E) bit allocation

Bit	7	6	5	4	3	2	1	0
Symbol	min_y[7:0]							
Reset	0	0	0	0	0	0	0	0
Access	R	R	R	R	R	R	R	R

Table 175. MIN_Z_MSB register (address 0x4F) bit allocation

Bit	7	6	5	4	3	2	1	0
Symbol	min_z[15:8]							
Reset	0	0	0	0	0	0	0	0
Access	R	R	R	R	R	R	R	R

Table 176. MIN_Z_LSB register (address 0x50) bit allocation

Bit	7	6	5	4	3	2	1	0
Symbol	min_z[7:0]							
Reset	0	0	0	0	0	0	0	0
Access	R	R	R	R	R	R	R	R

14.15 Magnetometer offset correction registers

14.15.1 M_OFF_X_MSB (address 0x3F), M_OFF_X_LSB, M_OFF_Y_MSB, M_OFF_Y_LSB, M_OFF_Z_MSB, M_OFF_Z_LSB (addresses 0x40 to 0x44) registers

The zero-field output for each axis can be adjusted by writing to these registers. The user must set M_CTRL_REG3[m_raw] = 0 (default) for the values in these registers to have any effect on the magnetic output data.

Desired offset should to be written into the 15 most-significant bits in each register pair using 2's complement representation. The offset registers have a sensitivity of 0.1 μ T/LSB and with an effective offset adjustment range of -1638.4μ T to $+1638.3 \mu$ T.

The magnetic field vectors represented in these registers will be subtracted from the magnetic field vectors acquired by the ASIC from the transducer prior to being written to the output data registers (registers 0x33 through 0x38). For example, to correct for an offset of 60 μ T, a value representing 60 μ T (= 60 μ T / 0.1 μ T/LSB = 600 LSB), which is 0x0258 in 15-bit two's complement representation, should be written to the offset registers following a left-shift for proper alignment (0x0258<<1 = 0x04b0).

Table 177. M_OFF_X_MSB register (address 0x3F) bit allocation

Bit	7	6	5	4	3	2	1	0
Symbol	m_off_x[14:7]							
Reset	0	0	0	0	0	0	0	0
Access	R/W	R/W	R/W	R/W	R/W	R/W	R/W	R/W

Table 178. M_OFF_X_LSB register (address 0x40) bit allocation

Bit	7	6	5	4	3	2	1	0
Symbol	m_off_x[6:0]							-
Reset	0	0	0	0	0	0	0	0
Access	R/W	R/W	R/W	R/W	R/W	R/W	R/W	R/W

Table 179. M_OFF_Y_MSB register (address 0x41) bit allocation

Bit	7	6	5	4	3	2	1	0
Symbol	m_off_y[14:7]							
Reset	0	0	0	0	0	0	0	0
Access	R/W	R/W	R/W	R/W	R/W	R/W	R/W	R/W

Table 180. M_OFF_Y_LSB register (address 0x42) bit allocation

Bit	7	6	5	4	3	2	1	0
Symbol	m_off_y[6:0]							-
Reset	0	0	0	0	0	0	0	0
Access	R/W	R/W	R/W	R/W	R/W	R/W	R/W	R/W

Table 181. M_OFF_Z_MSB register (address 0x43) bit allocation

Bit	7	6	5	4	3	2	1	0
Symbol	m_off_z[14:7]							
Reset	0	0	0	0	0	0	0	0
Access	R/W	R/W	R/W	R/W	R/W	R/W	R/W	R/W

Table 182. M_OFF_Z_LSB register (address 0x44) bit allocation

Bit	7	6	5	4	3	2	1	0
Symbol	m_off_z[6:0]							-
Reset	0	0	0	0	0	0	0	0
Access	R/W	R/W	R/W	R/W	R/W	R/W	R/W	R/W

14.16 Magnetometer threshold function registers

The magnetometer threshold function works in a similar manner to the freefall/motion detection module but uses magnetic data for the event detection instead of acceleration data. The m_ths_oae bit setting determines the logic used to evaluate the threshold detection function for the enabled axes. With m_ths_oae = 0, the magnetic sample data for each enabled axis must be below the threshold values specified in the MAG_THS_X/Y/Z registers for the time period specified in MAG_THS_COUNT before the event flag is triggered. For m_ths_oae = 1, any of the enabled axes must be above the threshold values specified in the MAG_THS_X/Y/Z registers for the time period specified in MAG_THS_COUNT before the event flag is triggered.

14.16.1 M_THS_CFG register (address 0x52)

Magnetic-field threshold detection configuration register.

Table 183. M_THS_CFG register (address 0x52) bit allocation

Bit	7	6	5	4	3	2	1	0
Symbol	m_ths_ele	m_ths_oae	m_ths_zefe	m_ths_yefe	m_ths_xefe	m_ths_wake_en	m_ths_int_en	m_ths_int_cfg
Reset	0	0	0	0	0	0	0	0
Access	R/W	R/W	R/W	R/W	R/W	R/W	R/W	R/W

Table 184. M_THS_CFG register (address 0x52) bit descriptions

Field	Description
m_ths_ele	Magnetic-threshold event latch enable. 0 – Event flag latch disabled. Magnetic-threshold events are not latched, and the event flag will change state with the real-time status of the event detection logic. 1 – Event flag latch enabled. Magnetic-threshold events are latched and the event flag can only be cleared by reading the M_THS_SRC register.
m_ths_oae	Magnetic-threshold event logic selection. 0 – Logical “AND” of enabled axes X, Y, and Z below threshold flags is used to detect the event. 1 – Logical “OR” of enabled axes X, Y, and Z above threshold flags is used to detect the event.
m_ths_zefe	Event-flag enable on Z-axis. 0 – Z-axis event detection disabled 1 – Raise event flag on measured magnetic field value above/below preset threshold for Z-axis
m_ths_yefe	Event-flag enable on Y-axis. 0 – Y-axis event detection disabled 1 – Raise event flag on measured magnetic field value above/below preset threshold for Y-axis
m_ths_xefe	Event-flag enable on X-axis. 0 – X-axis event detection disabled 1 – Raise event flag on measured magnetic field value above/below preset threshold for X-axis
m_ths_wake_en	0 – The system excludes the magnetic-threshold event flag when evaluating the auto-sleep/wake function. 1 – The system includes the magnetic-threshold event flag when evaluating the auto-sleep/wake function.
m_ths_int_en	0 – Magnetic-threshold interrupt is disabled. 1 – Magnetic-threshold interrupt is enabled.
m_ths_int_cfg	0 – Magnetic-threshold event flag is output on INT2 pin (logically OR'd with other INT2 interrupt events) 1 – Magnetic-threshold event flag is output on INT1 pin (logically OR'd with other INT1 interrupt events)

The unsigned 15-bit M_THS_X/Y/Z registers hold the threshold used for magnetic-event detection. With M_THS_CFG [m_ths_oae] = 0, the event is detected when all of the enabled axes are below or equal to their respective threshold values (AND condition). With M_THS_CFG [m_ths_oae] = 1, the event is detected when any of the enabled axes is above or equal to their respective threshold value (OR condition).

NOTE

The thresholds for each axis are applied on the magnetic data before it is corrected for the offset values stored in the M_OFF_X/Y/Z registers (when M_CTRL_REG3[m_raw] = 0). To apply thresholds on the user offset corrected data, it has to be implemented manually in the application software running on the MCU.

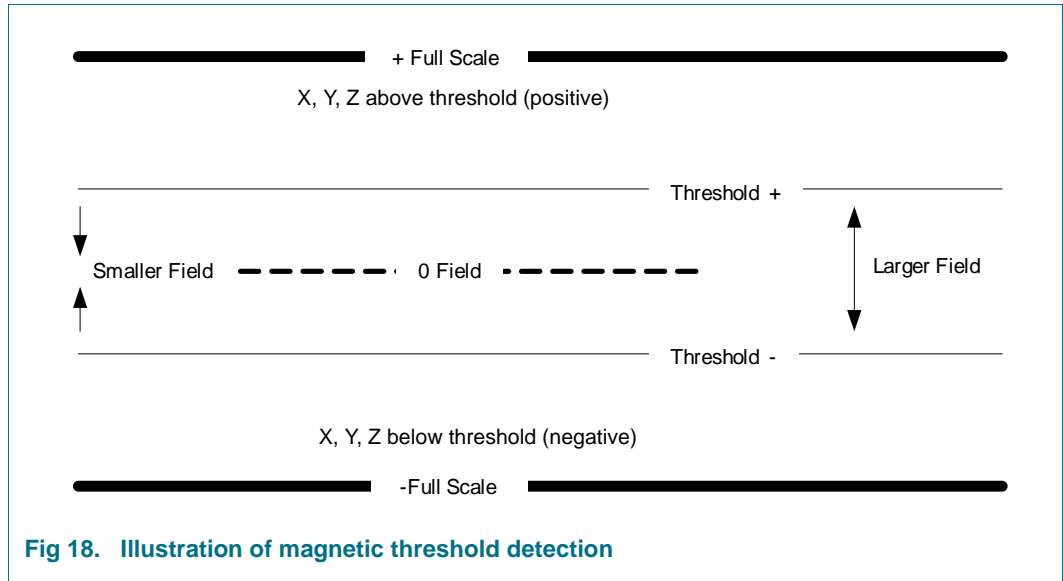

Fig 18. Illustration of magnetic threshold detection

14.16.2 M_THS_SRC register (address 0x53)

Magnetic-threshold interrupt source register.

This register keeps track of the magnetic threshold event which is triggering (or has triggered, when M_THS_CFG[m_ths_ele] = 1) the event flag. In particular, if M_THS_SRC[m_ths_ea] is set to a logic '1' then the logical combination of magnetic-event flags specified in M_THS_CFG is true.

Table 185. M_THS_SRC register (address 0x53) bit allocation

Bit	7	6	5	4	3	2	1	0
Symbol	m_ths_ea	-	m_ths_zhe	m_ths_zhp	m_ths_yhe	m_ths_yhp	m_ths_xhe	m_ths_xhp
Reset	0	0	0	0	0	0	0	0
Access	R	R	R	R	R	R	R	R

Table 186. M_THS_SRC register (address 0x53) bit descriptions

Field	Description
m_ths_ea	Event-active flag. 0 – No event flag has been asserted 1 – One or more event flag(s) has been asserted.
m_ths_zhe	Z-high event flag. 0 – No event detected 1 – Z-high event has been detected This bit always reads zero if the m_ths_zefe control bit is set to zero
m_ths_zhp	Z-high event polarity flag. 0 – Z event detected was positive polarity 1 – Z event detected was negative polarity This bit always reads zero if the m_ths_zefe control bit is set to zero

Table 186. M_THS_SRC register (address 0x53) bit descriptions - ¶continued

Field	Description
m_ths_yhe	Y-high event flag. 0 – No event detected 1 – Y-high event has been detected This bit always reads zero if the m_ths_yefe control bit is set to zero
m_ths_yhp	Y-high event polarity flag. 0 – Y event detected was positive polarity 1 – Y event detected was negative polarity This bit always reads zero if the m_ths_yefe control bit is set to zero
m_ths_xhe	X-high event flag. 0 – No event detected 1 – X-high event has been detected This bit always reads zero if the m_ths_xefe control bit is set to zero
m_ths_xhp	X-high event polarity flag. 0 – X event detected was positive polarity 1 – X event detected was negative polarity. This bit always reads zero if the m_ths_xefe control bit is set to zero

14.16.3 M_THS_X_MSB, M_THS_X_LSB, M_THS_Y_MSB, M_THS_Y_LSB, M_THS_Z_MSB, M_THS_Z_LSB (addresses 0x54 to 0x59) registers

The M_THS_X/Y/Z registers contain the unsigned 15-bit magnetic thresholds used by the magnetic-threshold function. Each register has a resolution of 0.1 μT/LSB. The thresholds for each axis are applied on the magnetic data before it is adjusted by the offset values stored in the M_OFF_X/Y/Z registers (when M_CTRL_REG3[m_raw] = 0). To apply thresholds on the user offset corrected data, it has to be implemented manually in the application

Table 187. M_THS_X_MSB register (address 0x54) bit allocation

Bit	7	6	5	4	3	2	1	0
Symbol	m_ths_dbcntm	m_ths_x[14:8]						
Reset	0	0	0	0	0	0	0	0
Access	R/W	R/W	R/W	R/W	R/W	R/W	R/W	R/W

Table 188. M_THS_X_MSB register (address 0x54) bit descriptions

Field	Description
m_ths_dbcntm	The m_ths_dbcntm bit configures the way in which the debounce counter is reset when the magnetic event of interest is momentarily not true. When m_ths_dbcntm = 1, the debounce counter is cleared to 0 whenever the magnetic event of interest is no longer true. When m_ths_dbcntm = 0, the debounce counter is decremented by 1 whenever the magnetic event of interest is no longer true.
m_ths_x[14:8]	Upper 7 bits of the 15-bit unsigned X-axis magnetic threshold.

Table 189. M_THS_X_LSB register (address 0x55) bit allocation

Bit	7	6	5	4	3	2	1	0
Symbol	m_ths_x[7:0]							
Reset	0	0	0	0	0	0	0	0
Access	R/W	R/W	R/W	R/W	R/W	R/W	R/W	R/W

Table 190. M_THS_Y_MSB register (address 0x56) bit allocation

Bit	7	6	5	4	3	2	1	0
Symbol	-	m_ths_y[14:8]						
Reset	0	0	0	0	0	0	0	0
Access	R/W	R/W	R/W	R/W	R/W	R/W	R/W	R/W

Table 191. M_THS_Y_LSB register (address 0x57) bit allocation

Bit	7	6	5	4	3	2	1	0
Symbol	m_ths_y[7:0]							
Reset	0	0	0	0	0	0	0	0
Access	R/W	R/W	R/W	R/W	R/W	R/W	R/W	R/W

Table 192. M_THS_Z_MSB register (address 0x58) bit allocation

Bit	7	6	5	4	3	2	1	0
Symbol	-	m_ths_z[14:8]						
Reset	0	0	0	0	0	0	0	0
Access	R/W	R/W	R/W	R/W	R/W	R/W	R/W	R/W

Table 193. M_THS_Z_LSB register (address 0x59) bit allocation

Bit	7	6	5	4	3	2	1	0
Symbol	m_ths_z[7:0]							
Reset	0	0	0	0	0	0	0	0
Access	R/W	R/W	R/W	R/W	R/W	R/W	R/W	R/W

14.16.4 M_THS_COUNT register (address 0x5A)

This register sets the number of debounce sample counts required before a magnetic threshold event is triggered. The behavior of the debounce counter is controlled by M_THS_X_MSB [m_ths_dbcntm].

Table 194. M_THS_COUNT register (address 0x5A) bit allocation

Bit	7	6	5	4	3	2	1	0
Symbol	m_ths_cnt[7:0]							
Reset	0	0	0	0	0	0	0	0
Access	R/W	R/W	R/W	R/W	R/W	R/W	R/W	R/W

Table 195. M_THS_COUNT register (address 0x5A) bit description

Field	Description
m_ths_cnt[7:0]	Magnetic threshold debounce count value.

When the internal debounce counter reaches the M_THS_COUNT value a magnetic event flag is set. The debounce counter will never increase beyond the M_THS_COUNT value. The time step used for the debounce sample count depends on the chosen ODR. When hybrid mode is enabled, the effective ODR is reduced by a factor of two, which increases the debounce counter time step by a factor of two from what is shown in [Table 196](#).

Table 196. M_THS_COUNT relationship with the ODR

ODR (Hz)	Time step (ms)	
	M_CTRL_REG1[m_hms] = 0b01	M_CTRL_REG1[m_hms] = 0b11
800	N/A	N/A
400	2.5	5
200	5	10
100	10	20
50	20	40
12.5	80	160
6.25	160	320
1.56	641	1282

For example, an ODR of 100 Hz and a M_THS_COUNT value of 15 would result in a debounce response time of 150 ms. In hybrid mode, the same settings would result in a debounce response time of 300 ms.

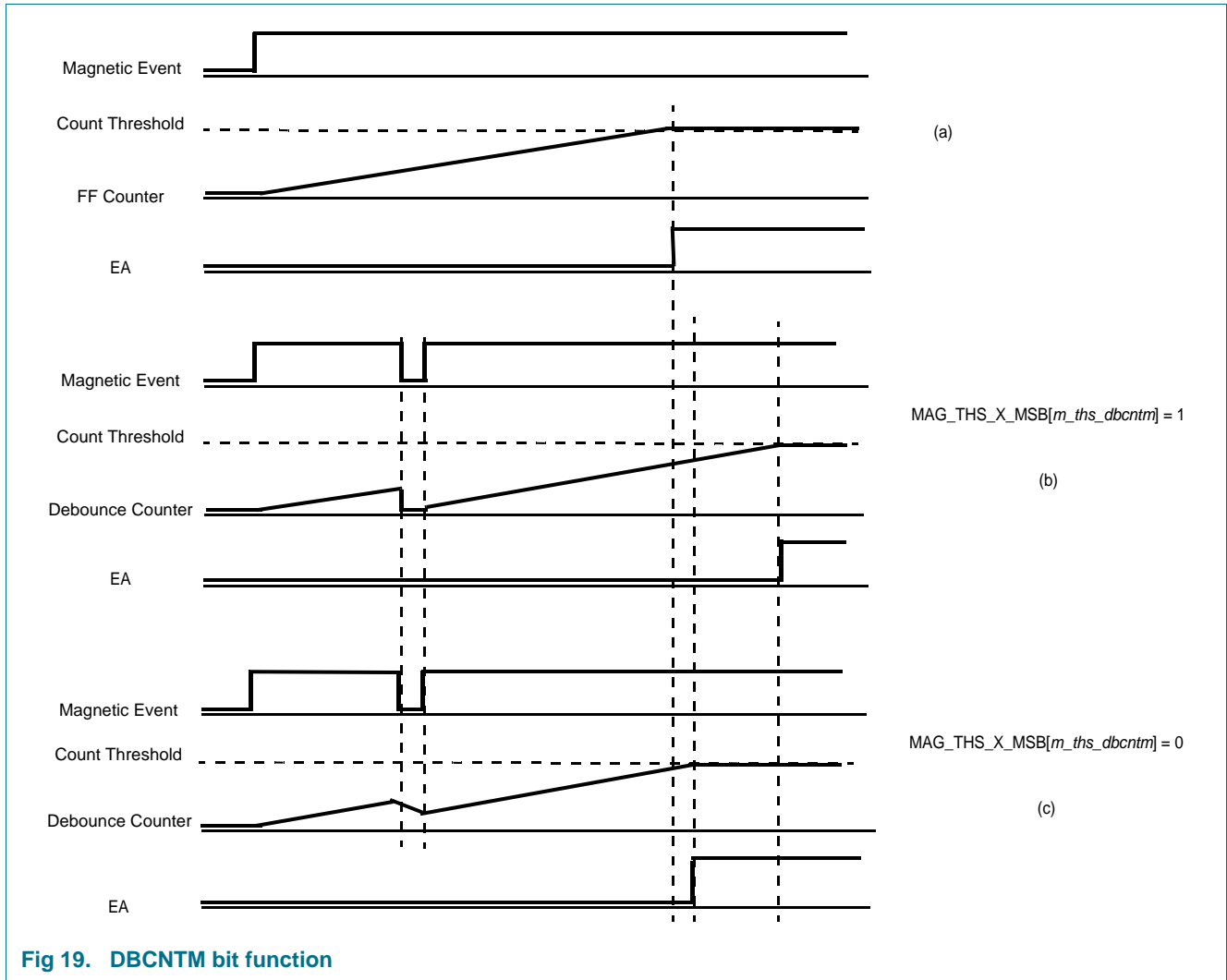

Fig 19. DBCNTM bit function

14.17 Magnetometer control registers

14.17.1 M_CTRL_REG1 register (address 0x5B)

Table 197. M_CTRL_REG1 register (address 0x5B) bit allocation

Bit	7	6	5	4	3	2	1	0
Symbol	m_acal	m_rst	m_ost	m_os[2:0]		m_hms[1:0]		
Reset	0	0	0	0	0	0	0	0
Access	R/W	R/W	R/W	R/W	R/W	R/W	R/W	R/W

Table 198. M_CTRL_REG1 register (address 0x5B) bit descriptions

Field	Description
m_acal	Magnetic hard-iron offset auto-calibration enable: 0 – Auto-calibration feature disabled 1 – Auto-calibration feature is enabled; the ASIC uses the maximum and minimum magnetic data to determine the hard iron offset value. The M_OFF_X/Y/Z registers are automatically loaded with (MAX_X/Y/Z + MIN_X/Y/Z)/2 for each axis at the end of every ODR cycle.
m_rst	One-shot magnetic reset degauss control bit: 0 – No magnetic sensor reset is active 1 – One-shot magnetic reset is enabled, hardware cleared when complete.
m_ost	One-shot triggered magnetic measurement mode: 0 – No action taken, or one-shot measurement complete. 1 – If device is in active mode no action is taken. If device is in standby mode, take one set of magnetic measurements, clear this bit, and return to standby mode.
m_os[2:0]	Oversample ratio (OSR) for magnetometer data (see Table 203).
m_hms[1:0]	0b00 – Only accelerometer sensor is active 0b01 – Only magnetometer sensor is active 0b11 – Hybrid mode, both accelerometer and magnetometer sensors are active ^[1]

[1] When operating in hybrid mode, the effective ODR for each sensor is half of the frequency selected in the CTRL_REG1[dr] and CTRL_REG1[asp_rate] bit fields.

The m_os[2:0] OSR setting along with the system ODR value set in CTRL_REG1 determines the magnetic output data update rate.

When m_hms[1:0] = 2'b11, magnetic output data is available in registers M_OUT_X_MSB (0x33), M_OUT_X_LSB (0x34), M_OUT_Y_MSB (0x35), M_OUT_Y_LSB (0x36), M_OUT_Z_MSB (0x37), and M_OUT_Z_LSB (0x38) along with the time synchronized accelerometer data in CMP_X_MSB (0x39), CMP_X_LSB (0x3A), CMP_Y_MSB (0x3B), CMP_Y_LSB (0x3C), CMP_Z_MSB (0x3D), and CMP_Z_LSB (0x3E).

NOTE

Switching time from hybrid- or magnetometer-only mode (in active mode), to standby mode (after configuring it to standby mode) varies from 0 to 300 sec.

To eliminate a fixed amount of wait time for the device to go into standby mode:

- Configure the device into standby mode.
- Continuously poll the SYSMOD (0x0B) register to check whether the device has gone to standby mode.

14.17.2 M_CTRL_REG2 register (address 0x5C)

Table 199. M_CTRL_REG2 register (address 0x5C) bit allocation

Bit	7	6	5	4	3	2	1	0
Symbol	-	-	hyb_autoinc_mode	m_maxmin_dis	m_maxmin_dis_ths	m_maxmin_rst	m_rst_cnt[1:0]	
Reset	0	0	0	0	0	0	0	0
Access	R/W	R/W	R/W	R/W	R/W	R/W	R/W	R/W

Table 200. M_CTRL_REG2 register (address 0x5C) bit descriptions

Field	Description
hyb_autoinc_mode	With hyb_autoinc_mode = 1 and fast-read mode is disabled (CTRL_REG1 [f_read] = 0), the register address will automatically advance to register 0x33 (M_OUT_X_MSB) after reading register 0x06 (OUT_Z_LSB) in burst-read mode. For hyb_autoinc_mode = 1 and fast-read mode enabled (CTRL_REG1[f_read] = 1) the register address will automatically advance to register 0x33 (M_OUT_X_MSB) after reading register 0x05 (OUT_Z_MSB) during a burst-read mode. Refer to the register map auto-increment address column for further information.
m_maxmin_dis	Magnetic measurement max/min detection function disable: 0 – Magnetic min/max detection function is enabled (default). 1 – Magnetic min/max detection function is disabled. When enabled, the magnetic min/max detection function will update the MAX_X/Y/Z and MIN_X/Y/Z registers at the end of each ODR cycle with the maximum and minimum magnetic measurements from each axis. This is used along with the auto-cal feature (M_CTRL_REG1[m_acal] = 1) as a hardware based hard-iron offset compensation function.
m_maxmin_dis_ths	Magnetic measurement min/max detection function disable using the magnetic threshold event trigger: 0 – No impact to magnetic min/max detection function on a magnetic threshold event 1 – Magnetic min/max detection function is disabled when magnetic threshold event is triggered
m_maxmin_rst	Magnetic measurement min/max detection function reset: 0 – No reset sequence is active 1 – Setting this bit resets the MIN_X/Y/Z and MAX_X/Y/Z registers to 0x7FFF and 0x8000, respectively (positive and negative full-scale values). This bit is automatically cleared after the reset is completed.
m_rst_cnt[1:0]	Magnetic sensor reset (degaussing) frequency: 0b00 – Automatic magnetic reset at the beginning of each ODR cycle (default). 0b01 – Automatic magnetic reset every 16 ODR cycles. 0b10 – Automatic magnetic reset every 512 ODR cycles. 0b11 – Automatic magnetic reset is disabled. Magnetic reset only occurs automatically on a transition from standby to active mode, or can be triggered manually by setting M_CTRL_REG1[m_rst] = 1

14.17.3 M_CTRL_REG3 register (address 0x5D)

Table 201. M_CTRL_REG3 register (address 0x5D) bit allocation

Bit	7	6	5	4	3	2	1	0
Symbol	m_raw	m_aslp_os[2:0]			m_ths_xyz_update	Reserved[2:0]		
Reset	0	0	0	0	0	0	0	0
Access	R/W	R/W	R/W	R/W	R/W	R/W	R/W	R/W

Table 202. M_CTRL_REG3 register (address 0x5D) bit descriptions

Field	Description
m_raw	Magnetic measurement RAW mode enable: 0 – Values stored in the M_OFF_X/Y/Z registers are applied to the magnetic sample data. This bit must be cleared in order for the automatic hard-iron compensation function to have any effect. 1 – Values stored in M_OFF_X/Y/Z are not applied to the magnetic sample data; automatic hard-iron compensation function does not have any effect on the output data.
m_aslp_os[2:0]	Defines magnetometer OSR in auto-sleep mode. See Table 203 .
m_ths_xyz_update	This control bit defines which reference values are updated when the magnetic threshold event detection function triggers. 0 – X, Y and Z reference values are all updated when the function triggers on any of the X, Y, or Z axes. 1 – Only the reference value for the axis that triggered the detection event is updated.

Table 203. M-cell OSR versus ODR

ODR (Hz)	OSR = 0	OSR = 1	OSR = 2	OSR = 3	OSR = 4	OSR = 5	OSR = 6	OSR = 7
1.56	16	16	32	64	128	256	512	1024
6.25	4	4	8	16	32	64	128	256
12.5	2	2	4	8	16	32	64	128
50	2	2	2	2	4	8	16	32
100	2	2	2	2	2	4	8	16
200	2	2	2	2	2	2	4	8
400	2	2	2	2	2	2	2	4
800	2	2	2	2	2	2	2	2

14.17.4 M_INT_SRC register (address 0x5E)

Table 204. M_INT_SRC register (address 0x5E) bit allocation

Bit	7	6	5	4	3	2	1	0
Symbol	-	-	-	-	-	src_m_ths	src_m_vecm	src_m_drdy
Reset	0	0	0	0	0	0	0	0
Access	R	R	R	R	R	R	R	R

Table 205. M_INT_SRC register (address 0x5E) bit description

Field	Description
src_m_ths	Magnetic threshold interrupt flag: 0 – Magnetic threshold event has not been detected. 1 – Magnetic threshold event has been detected.
src_m_vecm	Magnetic vector-magnitude interrupt flag: 0 – Magnetic vector-magnitude change event has not been detected. 1 – Magnetic vector-magnitude change event has been detected.
src_m_drdy	Magnetic data-ready interrupt flag: 0 – No new magnetic data is available. 1 – New magnetic data is available.

14.18 Magnetometer vector-magnitude function registers

The magnetometer vector-magnitude function will generate an interrupt when

$\sqrt{(m_x_out - m_x_ref)^2 + (m_y_out - m_y_ref)^2 + (m_z_out - m_z_ref)^2} > M_VECM_THS$ value and $t > M_VECM_CNT$ value. Where m_x_out , m_y_out , and m_z_out are the current decimated magnetometer output values, and m_x_ref , m_y_ref , and m_z_ref are the internally latched reference values. The user may program the M_VECM_THS and M_VECM_CNT registers to establish the conditions needed to detect a magnetic vector-magnitude change event. Depending on the values chosen for the reference values, this function may be configured to detect a magnetic field magnitude that is above a preset threshold (with reference values = 0), or a change in magnitude between two magnetic vectors greater than the preset threshold (with reference values non-zero). Please note x_ref , y_ref , z_ref are stored internally and are not observable by the user through the register interface. Refer to NXP application note AN4458.

14.18.1 M_VECM_CFG register (address 0x69)

Table 206. M_VECM_CFG register (address 0x69) bit allocation

Bit	7	6	5	4	3	2	1	0
Symbol	m_vecm_ele	m_vecm_initm	m_vecm_updm	m_vecm_en	m_vecm_wake_en	m_vecm_init_en	m_vecm_init_cfg	m_vecm_ele
Reset	0	0	0	0	0	0	0	0
Access	R/W	R/W	R/W	R/W	R/W	R/W	R/W	R/W

Table 207. M_VECM_CFG register (address 0x69) bit descriptions

Field	Description
m_vecm_ele	Magnetic vector-magnitude event latch enable: 0 – Event latch disabled 1 – Event latch enabled With event latching enabled, the src_m_vecm interrupt flag may only be cleared by reading the M_INT_SRC register. With event latching disabled, the src_m_vecm interrupt flag is updated in real time and may be cleared by the ASIC prior to the user reading the flag.
m_vecm_initm	Magnetic vector-magnitude initialization mode: 0 – The ASIC uses the current magnetic output data as the initial reference values at the time the m_vecm_en bit is set. 1 – The ASIC uses the data stored in the M_VECM_X/Y/Z_INIT registers as the initial reference values at the time the m_vecm_en bit is set.
m_vecm_updm	Magnetic vector-magnitude reference value update mode: 0 – The function updates the reference values with the current X, Y, and Z magnetic data when the event is triggered. 1 – The function does not update the reference values when the event is triggered. Setting m_vecm_initm = 1 and m_vecm_updm = 1 allows the user to manually update the reference values using the M_VECM_INIT_X/Y/Z registers in real time when the function is enabled.

Table 207. M_VECM_CFG register (address 0x69) bit descriptions - *continued*

Field	Description
m_vecm_en	<p>Magnetic vector-magnitude function enable:</p> <p>0 – Function is disabled.</p> <p>1 – Function is enabled, the ASIC will update the internal m_x/y/z_ref registers with either the current magnetic output data or the values stored in the M_VECM_INIT_X/Y/Z registers depending on the state of m_vecm_initm.</p> <p>Note: The magnetic vector-magnitude function will only function correctly up to a maximum ODR of 400 Hz.</p>
m_vecm_wake_en	<p>Magnetic vector-magnitude wake enable:</p> <p>0 – The system excludes the src_m_vecm event flag when evaluating the auto-sleep function.</p> <p>1 – The system includes the src_m_vecm event flag when evaluating the auto-sleep function.</p>
m_vecm_int_en	<p>Magnetic vector-magnitude interrupt enable:</p> <p>0 – Magnetic vector-magnitude interrupt is disabled.</p> <p>1 – Magnetic vector-magnitude interrupt is enabled.</p>
m_vecm_init_cfg	<p>Magnetic vector-magnitude interrupt configuration:</p> <p>0 – Magnetic vector-magnitude interrupt is output on INT2 pin.</p> <p>1 – Magnetic vector-magnitude interrupt is output on INT1 pin.</p>

14.18.2 M_VECM_THS_MSB register (address 0x6A)

Table 208. M_VECM_THS_MSB register (address 0x6A) bit allocation

Bit	7	6	5	4	3	2	1	0
Symbol	m_vecm_dbcntm	m_vecm_ths[14:8]						
Reset	0	0	0	0	0	0	0	0
Access	R/W	R/W	R/W	R/W	R/W	R/W	R/W	R/W

Table 209. M_VECM_THS_MSB register (address 0x6A) bit descriptions

Field	Description
m_vecm_dbcntm	<p>Magnetic vector-magnitude debounce counter mode selection:</p> <p>0 – The debounce counter is decremented by 1 whenever the current vector-magnitude result is below the threshold set in M_VECM_THS.</p> <p>1 – The debounce counter is cleared whenever the current vector-magnitude result is below the threshold set in M_VECM_THS.</p>
m_vecm_ths[14:8]	<p>Seven most significant bits of 15-bit unsigned magnetic vector-magnitude threshold. Resolution is 0.1 μT/LSB.</p>

14.18.3 M_VECM_THS_LSB register (address 0x6B)

Table 210. M_VECM_THS_LSB register (address 0x6B) bit allocation

Bit	7	6	5	4	3	2	1	0
Symbol	m_vecm_ths[7:0]							
Reset	0	0	0	0	0	0	0	0
Access	R/W	R/W	R/W	R/W	R/W	R/W	R/W	R/W

14.18.4 M_VECM_CNT register (address 0x6C)

Table 211. M_VECM_CNT register (address 0x6C) bit allocation

Bit	7	6	5	4	3	2	1	0
Symbol	m_vecm_cnt[7:0]							
Reset	0	0	0	0	0	0	0	0
Access	R/W	R/W	R/W	R/W	R/W	R/W	R/W	R/W

Table 212. M_VECM_CNT register (address 0x6C) bit description

Field	Description
m_vecm_cnt[7:0]	Vector-magnitude debounce count value.

The debounce timer period is determined by the ODR selected in CTRL_REG1; it is equal to the number indicated in M_VECM_CNT register times 1/ODR. For example, a value of 16 in M_VECM_CNT with an ODR setting of 400 Hz will result in a debounce period of 40 ms. Note that ODR is halved when in hybrid mode.

14.18.5 M_VECM_INITX_MSB register (address 0x6D)

Table 213. M_VECM_INITX_MSB register (address 0x6D) bit allocation

Bit	7	6	5	4	3	2	1	0
Symbol	m_vecm_initx[15:8]							
Reset	0	0	0	0	0	0	0	0
Access	R/W	R/W	R/W	R/W	R/W	R/W	R/W	R/W

Table 214. M_VECM_INITX_MSB register (address 0x6D) bit description

Field	Description
m_vecm_initx[15:8]	MSB of signed 16-bit initial X-axis value used by the magnetic vector-magnitude function when M_VECM_CFG[m_vecm_initm] = 1.

14.18.6 M_VECM_INITX_LSB register (address 0x6E)

Table 215. M_VECM_INITX_LSB register (address 0x6E) bit allocation

Bit	7	6	5	4	3	2	1	0
Symbol	m_vecm_initx[7:0]							
Reset	0	0	0	0	0	0	0	0
Access	R/W	R/W	R/W	R/W	R/W	R/W	R/W	R/W

Table 216. M_VECM_INITX_LSB register (address 0x6E) bit description

Field	Description
m_vecm_initx[7:0]	LSB of signed 16-bit initial X-axis value used by the magnetic vector-magnitude function when M_VECM_CFG[m_vecm_initm] = 1.

14.18.7 M_VECM_INITY_MSB register (address 0x6F)

Table 217. M_VECM_INITY_MSB register (address 0x6F) bit allocation

Bit	7	6	5	4	3	2	1	0
Symbol	m_vecm_inity[15:8]							
Reset	0	0	0	0	0	0	0	0
Access	R/W	R/W	R/W	R/W	R/W	R/W	R/W	R/W

Table 218. M_VECM_INITY_MSB register (address 0x6F) bit description

Field	Description
m_vecm_inity[15:8]	MSB of signed 16-bit initial Y-axis value used by the magnetic vector-magnitude function when M_VECM_CFG[m_vecm_initm] = 1.

14.18.8 M_VECM_INITY_LSB register (address 0x70)

Table 219. M_VECM_INITY_LSB register (address 0x70) bit allocation

Bit	7	6	5	4	3	2	1	0
Symbol	m_vecm_inity[7:0]							
Reset	0	0	0	0	0	0	0	0
Access	R/W	R/W	R/W	R/W	R/W	R/W	R/W	R/W

Table 220. M_VECM_INITY_LSB register (address 0x70) bit description

Field	Description
m_vecm_inity[7:0]	LSB of signed 16-bit initial Y-axis value used by the magnetic vector-magnitude function when M_VECM_CFG[m_vecm_initm] = 1.

14.18.9 M_VECM_INITZ_MSB register (address 0x71)

Table 221. M_VECM_INITZ_MSB register (address 0x71) bit allocation

Bit	7	6	5	4	3	2	1	0
Symbol	m_vecm_initz[15:8]							
Reset	0	0	0	0	0	0	0	0
Access	R/W	R/W	R/W	R/W	R/W	R/W	R/W	R/W

Table 222. M_VECM_INITZ_MSB register (address 0x71) bit description

Field	Description
m_vecm_initz[15:8]	MSB of signed 16-bit initial Z-axis value used by the magnetic vector-magnitude function when M_VECM_CFG[m_vecm_initm] = 1.

14.18.10 M_VECM_INITZ_LSB register (address 0x72)

Table 223. M_VECM_INITZ_LSB register (address 0x72) bit allocation

Bit	7	6	5	4	3	2	1	0
Symbol	m_vecm_initz[15:8]							
Reset	0	0	0	0	0	0	0	0
Access	R/W	R/W	R/W	R/W	R/W	R/W	R/W	R/W

Table 224. M_VECM_INITZ_LSB register (address 0x72) bit description

Field	Description
m_vecm_initz[7:0]	LSB of signed 16-bit initial Z-axis value used by the magnetic vector-magnitude function when M_VECM_CFG[m_vecm_initm] = 1.

15. Package outline

This drawing is located at http://cache.nxp.com/files/shared/doc/package_info/98ASA00318D.pdf.

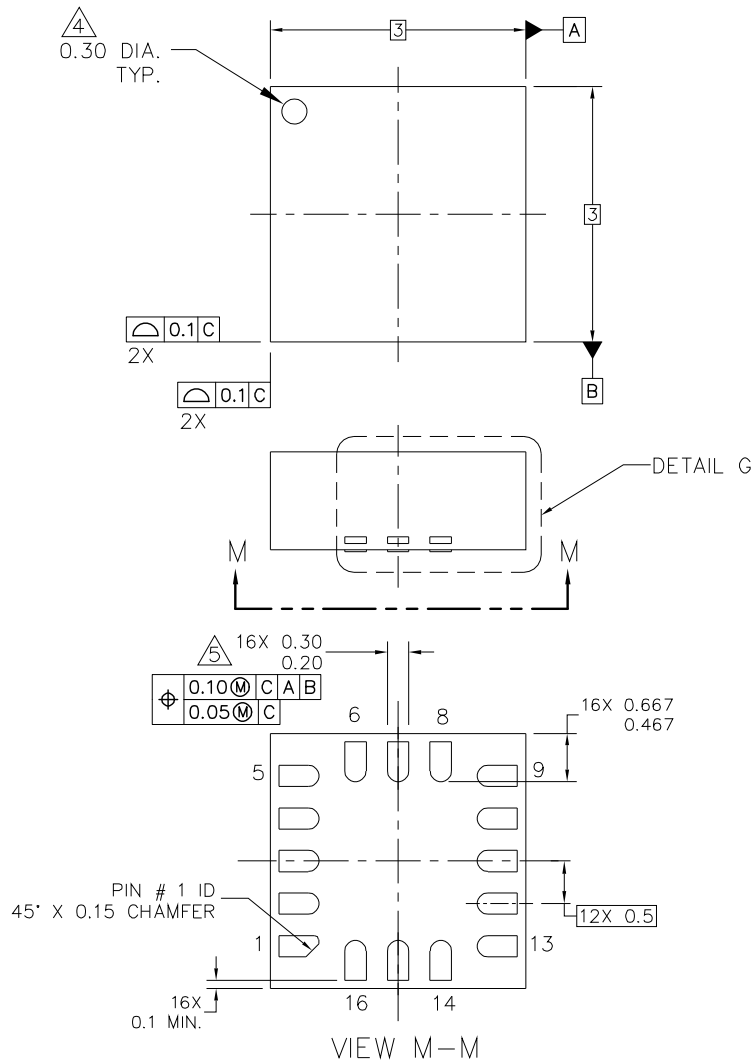

© FREESCALE SEMICONDUCTOR, INC. ALL RIGHTS RESERVED.	MECHANICAL OUTLINE	PRINT VERSION NOT TO SCALE	
TITLE: QFN-COL, 3 X 3 X 1.2, 0.5 PITCH, 16 TERMINAL	DOCUMENT NO: 98ASA00318D	REV: A	
	CASE NUMBER: 2188-02	20 NOV 2012	
	STANDARD: NON JEDEC		

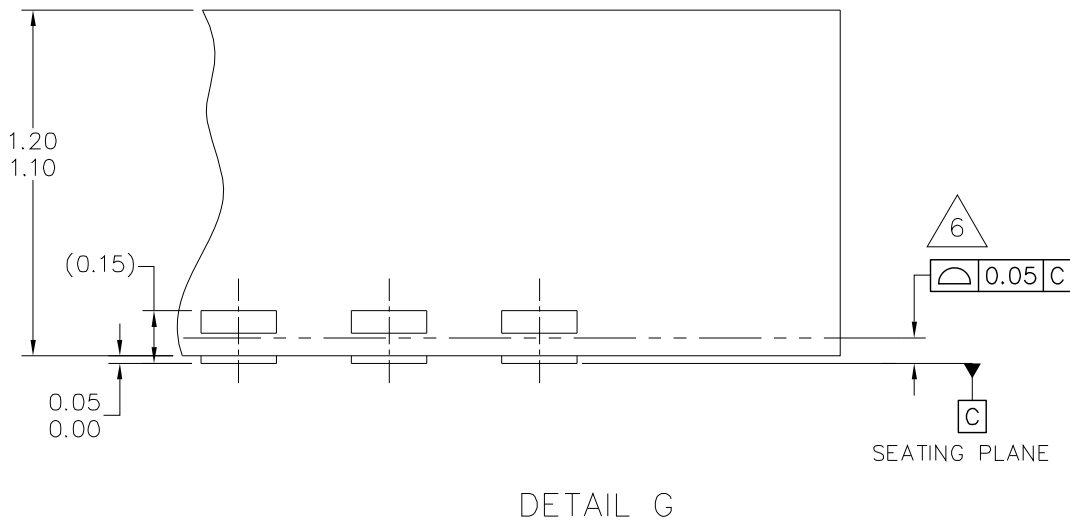

Fig 20. Package outline 16-lead QFN, 3 mm x 3 mm x 1.2 mm



© FREESCALE SEMICONDUCTOR, INC. ALL RIGHTS RESERVED.	MECHANICAL OUTLINE	PRINT VERSION NOT TO SCALE	
TITLE: QFN-COL, 3 X 3 X 1.2, 0.5 PITCH, 16 TERMINAL	DOCUMENT NO: 98ASA00318D	REV: A	
	CASE NUMBER: 2188-02	20 NOV 2012	
	STANDARD: NON JEDEC		

Fig 21. Package outline 16-lead QFN, 3 mm x 3 mm x 1.2 mm

NOTES:

1. ALL DIMENSIONS ARE IN MILLIMETERS.
2. INTERPRET DIMENSIONS AND TOLERANCES PER ASME Y14.5M-1994.
3. THIS IS NON JEDEC REGISTERED PACKAGE.
4.  PIN #1 ID ON TOP WILL BE LASER MARKED.
5.  THIS DIMENSION APPLIES TO METALLIZED TERMINAL AND IS MEASURED BETWEEN 0.15 AND 0.30mm FROM TERMINAL TIP. IF THE TERMINAL HAS THE OPTIONAL RADIUS ON THE OTHER END OF THE TERMINAL, THIS DIMENSION SHOULD NOT BE MEASURED IN THAT RADIUS AREA.
6.  COPLANARITY APPLIES TO LEADS AND ALL OTHER BOTTOM SURFACE METALLIZATION.
7. MIN. METAL GAP SHOULD BE 0.2MM.

© FREESCALE SEMICONDUCTOR, INC. ALL RIGHTS RESERVED.	MECHANICAL OUTLINE	PRINT VERSION NOT TO SCALE	
TITLE: QFN-COL, 3 X 3 X 1.2, 0.5 PITCH, 16 TERMINAL		DOCUMENT NO: 98ASA00318D	REV: A
		CASE NUMBER: 2188-02	20 NOV 2012
		STANDARD: NON JEDEC	

Fig 22. Package outline 16-lead QFN, 3 mm x 3 mm x 1.2 mm

16. Packing information

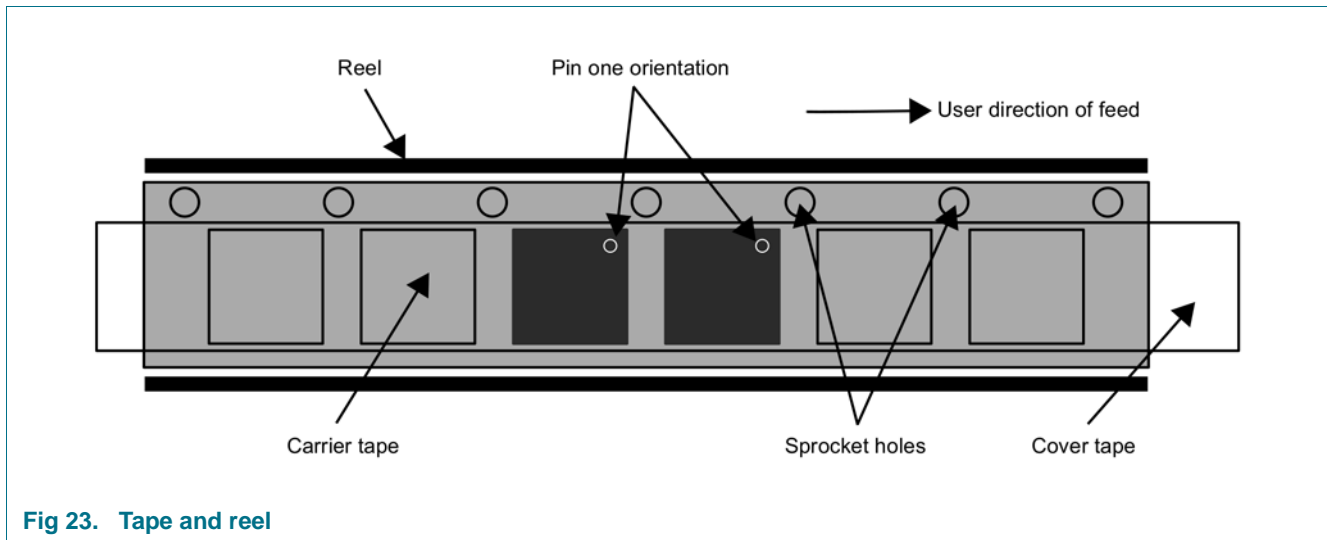

Fig 23. Tape and reel

17. Mounting guidelines for the quad flat no-lead (QFN) package

17.1 Soldering information

The QFN package is compliant with the RoHS standards. Refer to NXP application note AN4077 for more information.

Printed circuit board (PCB) layout is a critical portion of the total design. The footprint for the surface mount packages must be the correct size to ensure proper solder connection interface between the PCB and the package. With the correct footprint, the packages will self-align when subjected to a solder reflow process.

These guidelines are for soldering and mounting the quad flat no-lead (QFN) package inertial sensors to PCBs. The purpose is to minimize the stress on the package after board mounting. The FXOS8700CQ uses the QFN package platform. This section describes suggested methods of soldering these devices to the PCB for consumer applications.

Refer to NXP application note AN4247, "Layout Recommendation for PCBs Using a Magnetometer Sensor" for a technical discussion on hard and soft-iron magnetic interference and general guidelines on layout and component selection applicable to any PCB using a magnetometer sensor.

NXP application note AN1902, "Quad Flat Pack No-Lead (QFN) Micro Dual Flat Pack No-Lead (DFN)" discusses the QFN package used by the FXOS8700CQ, PCB design guidelines for using QFN packages and temperature profiles for reflow soldering.

17.2 Overview of soldering considerations

Information provided here is based on experiments executed on QFN devices. As they cannot represent exact conditions present at a customer site, the information provided herein should be used for guidance only and further process and design optimizations are

recommended to develop an application specific solution. It should be noted that with the proper PCB footprint and solder stencil designs, the package will self-align during the solder reflow process.

The QFN package is compliant with the RoHS standards. Please refer to NXP application note AN4077 for more information.

17.3 Halogen content

This package is designed to be Halogen free, exceeding most industry and customer standards. Halogen free means that no homogeneous material within the assembled package will contain chlorine (Cl) in excess of 700 ppm or 0.07% weight/weight or bromine (Br) in excess of 900 ppm or 0.09% weight/weight.

17.4 PCB mounting recommendations

- The PCB land should be designed with non-solder mask defined (NSMD) as shown in [Figure 24](#) and [Figure 25](#).
- No additional via pattern underneath package.
- PCB land pad is 0.8 mm by 0.3 mm as shown in [Figure 24](#) and [Figure 25](#).
- Solder mask opening = PCB land pad edge + 0.113 mm larger all around.
- Stencil opening = PCB land pad –0.015 mm smaller all around = 0.77 mm by 0.27 mm.
- Stencil thickness is 100 or 125 μm .
- Do not place any components or vias at a distance less than 2 mm from the package land area. This may cause additional package stress if it is too close to the package land area.
- Signal traces connected to pads should be as symmetric as possible. Put dummy traces on the NC pads in order to have same length of exposed trace for all pads.
- Use a standard pick and place process and equipment. Do not use a hand soldering process.
- Do not use a screw down or stacking to fix the PCB into an enclosure as this could bend the PCB, putting stress on the package.
- The PCB should be rated for the multiple lead-free reflow condition with max 260 °C temperature.
- No copper traces on top layer of PCB under the package. This will cause planarity issues with board mount. NXP QFN sensors are compliant with Restrictions on Hazardous Substances (RoHS), having halide-free molding compound (green) and lead-free terminations. These terminations are compatible with tin-lead (Sn-Pb) as well as tin-silver-copper (Sn-Ag-Cu) solder paste soldering processes. Reflow profiles applicable to those processes can be used successfully for soldering the devices.

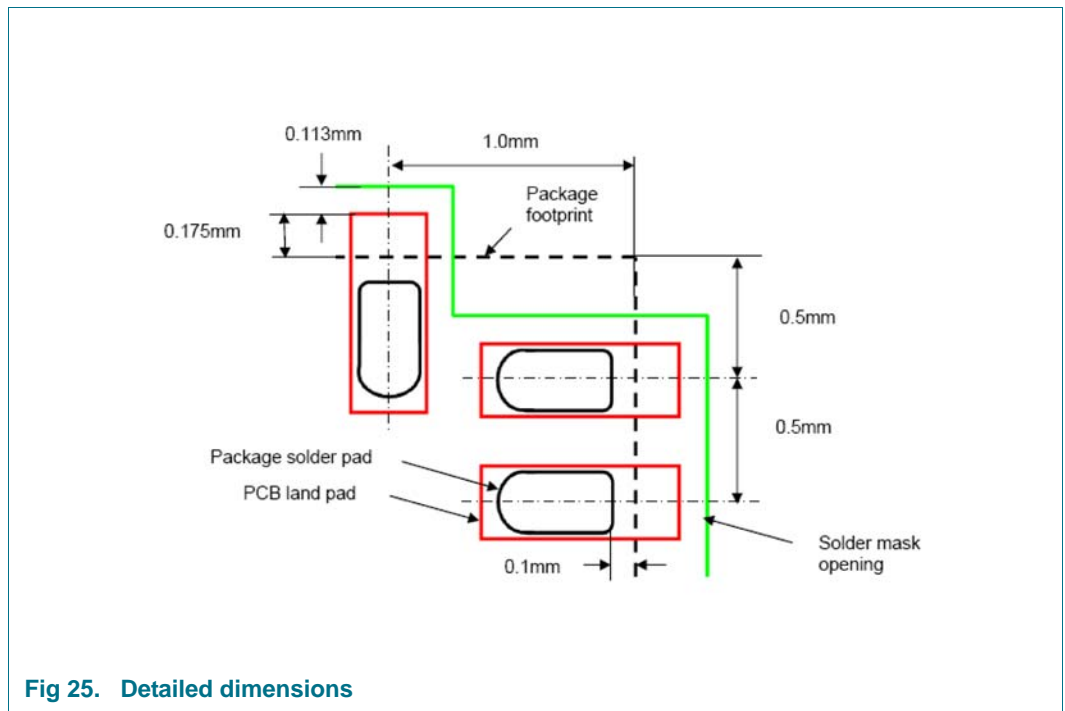
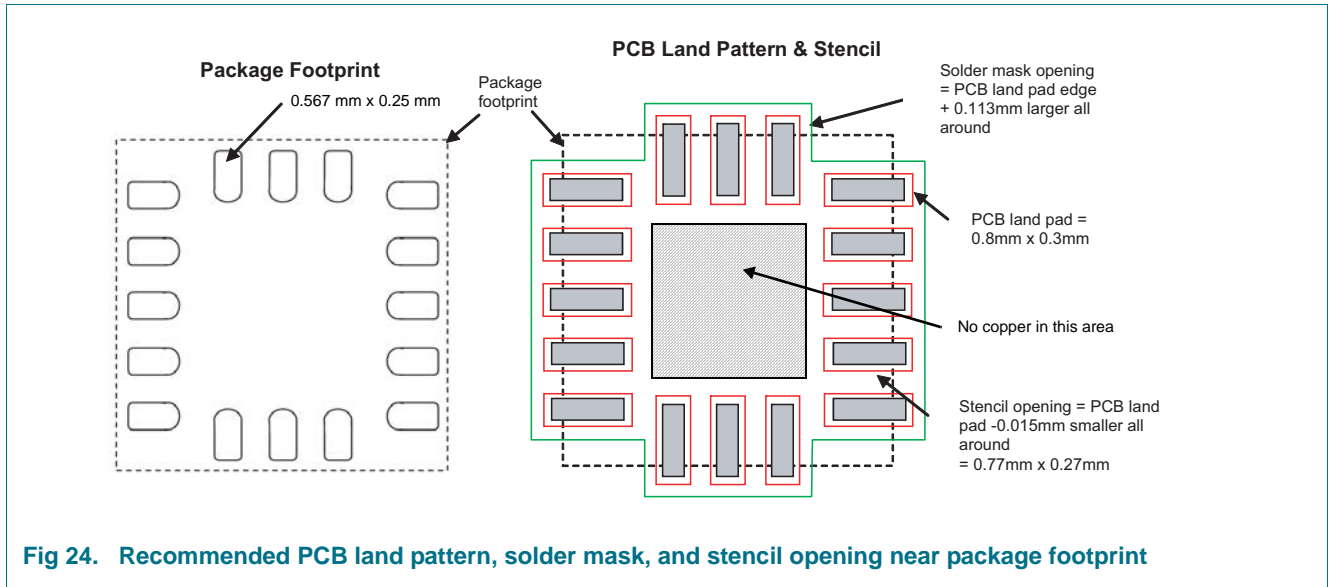

18. Package thermal characteristics

Table 225. Thermal resistance data

Rating	Description	Symbol	Value	Unit
Junction-to-ambient, natural convection ^{[1][2]}	Single-layer board	$R_{\theta JA}$	163	°C/W
Junction-to-ambient, natural convection ^{[1][3]}	Four-layer board (two signals, two planes)		70	
Junction-to-board ^[4]	-	$R_{\theta JB}$	33	°C/W
Junction-to-case (top) ^[5]	-	$R_{\theta JCTop}$	84	°C/W
Junction-to-package (top) ^[6]	Natural convection	Ψ_{JT}	6	°C/W

- [1] Junction temperature is a function of die size, on-chip power dissipation, package thermal resistance, mounting site (board) temperature, ambient temperature, air flow, power dissipation of other components on the board, and board thermal resistance.
- [2] Per JEDEC JESD51-2 with the single-layer board (JESD51-3) horizontal.
- [3] Per JEDEC JESD51-6 with the board (JESD51-7) horizontal.
- [4] Thermal resistance between the die and the printed circuit board per JEDEC JESD51-8. Board temperature is measured on the top surface of the board near the package.
- [5] Thermal resistance between the die and the case top surface as measured by the cold plate method (MIL SPEC-883 Method 1012.1).
- [6] Thermal characterization parameter indicating the temperature difference between package top and the junction temperature per JEDEC JESD51-2. When Greek letters are not available, the thermal characterization parameter is written as Psi-JT.

19. Revision history

Table 226. Revision history

Document ID	Release date	Data sheet status	Change notice	Supersedes
FXOS8700CQ1 v.7.0	20160315	Product data sheet	-	FXOS8700CQ v.6
Modifications:	<ul style="list-style-type: none"> • Global update: Removed instances of self-test for the magnetometer. Including update to last bullet on first page. Removed self-test input on magnetometer on Figure 1, updated Section 8.3, removed self-test output change row on Table 3 and removed magnetic self-test function bits on Table 201 and Table 202. • Updated bullets in Section 2, features and benefits and Section 3, applications. • Section 9.5: Table 8, updated value on maximum exposed magnetic field without perming row; was 10,000 to 3000. • Section 14: Table 16, added and deleted footnote references. • Section 14.1.5: Table 28, corrected description for sysmod[1:0] was “0b01: Sleep mode” to “0b10: Sleep mode”. • Section 14.1.9: Table 37, updated description for rst, changing parts of paragraphs to a “Note”. • Section 14.9.4: Table 86, corrected description for a_ffmt_ths_xyz_en • Section 14.17.1: Updated NOTE following Table 198. • Added Section 16, Packing information. 			
FXOS8700CQ v.6.0	20150918	Product data sheet	-	FXOS8700CQ v.5.0
FXOS8700CQ v.5.0	20150527	Product data sheet	-	FXOS8700CQ v.4.1
FXOS8700CQ v.4.1	20150113	Product data sheet	-	FXOS8700CQ v.4.0
FXOS8700CQ v.4.0	20140305	Product data sheet	-	FXOS8700CQ v.3
FXOS8700CQ v.3	20130719	Product data sheet	-	FXOS8700CQ v.2
FXOS8700CQ v.2	20130511	Product data sheet	-	FXOS8700CQ v.1
FXOS8700CQ v.1	20120616	Advance information	-	-

20. Legal information

20.1 Data sheet status

Document status ^[1]	Product status ^[2]	Definition
Product preview	Development	This document contains certain information on a product under development. Freescale reserves the right to change or discontinue this product without notice.
Advance information	Qualification	This document contains information on a new product. Specifications and information herein are subject to change without notice.
Technical data	Production	NXP Semiconductors reserves the right to change the detail specifications as may be required to permit improvements in the design of its products.

[1] Please consult the most recently issued document before initiating or completing a design.

[2] The product status of device(s) described in this document may have changed since this document was published and may differ in case of multiple devices. The latest product status information is available on the Internet at URL <http://www.nxp.com>.

21. Contents

1	General description	1	12.10	Acceleration vector-magnitude detection	23
2	Features and benefits	1	12.11	Magnetic vector-magnitude detection	24
3	Applications	2	12.12	Magnetic threshold detection	24
4	Ordering information	2	12.13	Magnetic min/max detection (autonomous calibration)	24
5	Block diagram	3	13	Example FXOS8700CQ driver code	25
6	Pinning information	4	13.1	Introduction	25
6.1	Pinning	4	13.2	FXOS8700CQ addresses	25
6.2	Pin description	5	13.3	Sensor data structure	26
7	Electrical connections	5	13.4	FXOS8700CQ configuration function	26
7.1	Orientation	7	13.5	Data read function	28
8	Terminology	7	14	Register descriptions	30
8.1	Sensitivity	7	14.1	Device configuration registers	38
8.2	Zero-g and zero-flux offset	7	14.1.1	STATUS register (address 0x00)	38
8.3	Self-test	8	14.1.2	DR_STATUS register (address 0x00)	38
9	Device characteristics	8	14.1.3	F_STATUS register (address 0x00)	40
9.1	Accelerometer mechanical characteristics	8	14.1.4	TRIG_CFG register (address 0x0A)	40
9.2	Magnetometer magnetic characteristics	9	14.1.5	SYSMOD register (address 0x0B)	41
9.3	Hybrid characteristics	10	14.1.6	INT_SOURCE register (address 0x0C)	41
9.4	Electrical characteristics	10	14.1.7	WHO_AM_I register (address 0x0D)	43
9.5	Absolute maximum ratings	12	14.1.8	CTRL_REG1 register (address 0x0A)	43
10	Digital interfaces	13	14.1.9	CTRL_REG2 register (address 0x2B)	45
10.1	I ² C interface characteristics	13	14.1.10	CTRL_REG3 - interrupt control register (address 0x2C)	47
10.1.1	General I ² C operation	14	14.1.11	CTRL_REG4 - interrupt enable register (address 0x2D)	48
10.1.2	I ² C read/write operations	15	14.1.12	CTRL_REG5 - interrupt routing configuration register (address 0x2E)	49
10.2	SPI interface characteristics	16	14.2	Auto-sleep trigger register	51
10.2.1	General SPI operation	17	14.2.1	ASLP_COUNT register (address 0x29)	51
10.2.2	SPI read/write operations	18	14.3	Temperature register	53
10.2.3	I ² C/SPI auto detection	19	14.3.1	TEMP register (address 0x51)	53
10.2.4	Power supply sequencing and I ² C/SPI mode auto-detection	19	14.4	Accelerometer output data registers	53
11	Modes of operation	19	14.4.1	OUT_X_MSB, OUT_X_LSB, OUT_Y_MSB, OUT_Y_LSB, OUT_Z_MSB, OUT_Z_LSB (addresses 0x01 to 0x06) registers	53
12	Embedded functionality	20	14.5	Accelerometer FIFO register	55
12.1	Factory calibration	20	14.5.1	F_SETUP register (address 0x09)	55
12.2	8-bit or 14-bit accelerometer data	21	14.6	Accelerometer sensor data configuration register	56
12.3	Accelerometer low-power modes versus high-resolution modes	21	14.6.1	XYZ_DATA_CFG register (address 0x0E)	56
12.4	Auto-wake/sleep mode	21	14.7	Accelerometer high-pass filter register	57
12.5	Hybrid mode	22	14.7.1	HP_FILTER_CUTOFF register (address 0x0F)	57
12.6	Accelerometer freefall and motion event detection	22	14.8	Portrait/landscape detection registers	58
12.6.1	Freefall detection	22	14.8.1	PL_STATUS register (address 0x10)	59
12.6.2	Motion detection	22	14.8.2	PL_CFG register (address 0x11)	60
12.7	Transient detection	22	14.8.3	PL_COUNT register (address 0x12)	60
12.8	Pulse detection	23			
12.9	Orientation detection	23			

continued >>

14.8.4	PL_BF_ZCOMP register (address 0x13)	61	14.14.3	CMP_X_MSB (address 0x39), CMP_X_LSB, CMP_Y_MSB, CMP_Y_LSB, CMP_Z_MSB, CMP_Z_LSB (addresses 0x3A to 0x3E) registers	87
14.8.5	PL_THS_REG register (address 0x14)	62	14.14.4	MAX_X_MSB, MAX_X_LSB, MAX_Y_MSB, MAX_Y_LSB, MAX_Z_MSB (addresses 0x45 to 0x49), MAX_Z_LSB (address 0x4A) registers	88
14.9	Freefall and motion detection registers.	63	14.14.5	MIN_X_MSB, MIN_X_LSB, MIN_Y_MSB, MIN_Y_LSB, MIN_Z_MSB (addresses 0x4B to 0x4F), MIN_Z_LSB (address 0x50) registers	89
14.9.1	A_FFMT_CFG register (address 0x15)	63	14.15	Magnetometer offset correction registers. . . .	90
14.9.2	A_FFMT_SRC register (address 0x16)	64	14.15.1	M_OFF_X_MSB (address 0x3F), M_OFF_X_LSB, M_OFF_Y_MSB, M_OFF_Y_LSB, M_OFF_Z_MSB, M_OFF_Z_LSB (addresses 0x40 to 0x44) registers	90
14.9.3	A_FFMT_THS register (address 0x17).	65	14.16	Magnetometer threshold function registers . .	91
14.9.4	A_FFMT_THS_X_MSB, A_FFMT_THS_X_LSB, A_FFMT_THS_Y_MSB, A_FFMT_THS_Y_LSB, A_FFMT_THS_Z_MSB, A_FFMT_THS_Z_LSB registers (addresses 0x73 to 0x78)	66	14.16.1	M_THS_CFG register (address 0x52)	91
14.9.5	A_FFMT_COUNT register (address 0x18). . .	68	14.16.2	M_THS_SRC register (address 0x53)	93
14.10	Accelerometer vector-magnitude function register	69	14.16.3	M_THS_X_MSB, M_THS_X_LSB, M_THS_Y_MSB, M_THS_Y_LSB, M_THS_Z_MSB, M_THS_Z_LSB (addresses 0x54 to 0x59) registers	94
14.10.1	A_VECM_CFG register (address 0x5F)	70	14.16.4	M_THS_COUNT register (address 0x5A) . . .	95
14.10.2	A_VECM_THS_MSB (address 0x60) register	70	14.17	Magnetometer control registers	97
14.10.3	A_VECM_THS_LSB register (address 0x61). .	71	14.17.1	M_CTRL_REG1 register (address 0x5B) . . .	97
14.10.4	A_VECM_CNT register (address 0x62)	71	14.17.2	M_CTRL_REG2 register (address 0x5C) . . .	98
14.10.5	A_VECM_INITX_MSB register (address 0x63)	71	14.17.3	M_CTRL_REG3 register (address 0x5D) . . .	99
14.10.6	A_VECM_INITX_LSB register (address 0x64)	72	14.17.4	M_INT_SRC register (address 0x5E)	100
14.10.7	A_VECM_INITY_MSB register (address 0x65)	72	14.18	Magnetometer vector-magnitude function registers	101
14.10.8	A_VECM_INITY_LSB register (address 0x66)	72	14.18.1	M_VECM_CFG register (address 0x69) . . .	101
14.10.9	A_VECM_INITZ_MSB register (address 0x67)	72	14.18.2	M_VECM_THS_MSB register (address 0x6A)	102
14.10.10	A_VECM_INITZ_LSB register (address 0x68)	73	14.18.3	M_VECM_THS_LSB register (address 0x6B)	102
14.11	Transient (AC) acceleration detection registers	73	14.18.4	M_VECM_CNT register (address 0x6C) . . .	103
14.11.1	TRANSIENT_CFG register (address 0x1D) . .	74	14.18.5	M_VECM_INITX_MSB register (address 0x6D)	103
14.11.2	TRANSIENT_SRC register (address 0x1E) . .	74	14.18.6	M_VECM_INITX_LSB register (address 0x6E)	103
14.11.3	TRANSIENT_THS register (address 0x1F) . .	75	14.18.7	M_VECM_INITY_MSB register (address 0x6F)	104
14.11.4	TRANSIENT_COUNT register (address 0x20)	76	14.18.8	M_VECM_INITY_LSB register (address 0x70)	104
14.12	Pulse detection registers	77	14.18.9	M_VECM_INITZ_MSB register (address 0x71)	104
14.12.1	PULSE_CFG register (address 0x21)	77	14.18.10	M_VECM_INITZ_LSB register (address 0x72)	104
14.12.2	PULSE_SRC register (address 0x22)	78	15	Package outline	105
14.12.3	PULSE_THSX register (address 0x23)	79	16	Packing information	108
14.12.4	PULSE_THSY register (address 0x24)	79			
14.12.5	PULSE_THSZ register (address 0x25).	80			
14.12.6	PULSE_TMLT register (address 0x26).	80			
14.12.7	PULSE_LTCY register (address 0x27).	81			
14.12.8	PULSE_WIND register (address 0x28)	82			
14.13	Accelerometer offset correction registers . . .	83			
14.13.1	OFF_X register (address 0x2F)	83			
14.13.2	OFF_Y register (address 0x30)	84			
14.13.3	OFF_Z register (address 0x31)	84			
14.14	Magnetometer data registers	84			
14.14.1	M_DR_STATUS register (address 0x32)	84			
14.14.2	M_OUT_X_MSB, M_OUT_X_LSB, M_OUT_Y_MSB, M_OUT_Y_LSB, M_OUT_Z_MSB, M_OUT_Z_LSB registers (addresses 0x33 to 0x38)	86			

[continued >>](#)

17 Mounting guidelines for the quad flat no-lead (QFN) package 108

17.1 Soldering information 108

17.2 Overview of soldering considerations 108

17.3 Halogen content 109

17.4 PCB mounting recommendations 109

18 Package thermal characteristics 111

19 Revision history 112

20 Legal information 113

Please be aware that important notices concerning this document and the product(s) described herein, have been included in section 'Legal information'.

© NXP B.V. 2016.

All rights reserved.

For more information, please visit: <http://www.nxp.com>

For sales office addresses, please send an email to: salesaddresses@nxp.com

Date of release: 21 March 2016

Document identifier: FXOS8700CQ



How to Reach Us:

Home Page:

[NXP.com](http://www.nxp.com)

Web Support:

<http://www.nxp.com/support>

Information in this document is provided solely to enable system and software implementers to use NXP products. There are no expressed or implied copyright licenses granted hereunder to design or fabricate any integrated circuits based on the information in this document. NXP reserves the right to make changes without further notice to any products herein.

NXP makes no warranty, representation, or guarantee regarding the suitability of its products for any particular purpose, nor does NXP assume any liability arising out of the application or use of any product or circuit, and specifically disclaims any and all liability, including without limitation, consequential or incidental damages. "Typical" parameters that may be provided in NXP data sheets and/or specifications can and do vary in different applications, and actual performance may vary over time. All operating parameters, including "typicals," must be validated for each customer application by the customer's technical experts. NXP does not convey any license under its patent rights nor the rights of others. NXP sells products pursuant to standard terms and conditions of sale, which can be found at the following address:

<http://www.nxp.com/terms-of-use.html>.

NXP, the NXP logo, Freescale, and the Freescale logo, are trademarks of NXP B.V. All other product or service names are the property of their respective owners. All rights reserved.

© 2016 NXP B.V.

Document Number: FXOS8700CQ

Rev. 7.0

3/2016

