

APPROVAL SHEET

WLPM706630 Series SMD Molded Power Inductor



*Contents in this sheet are subject to change without prior notice.

Features

1. Shielded construction.
2. Ultra low buzz noise.
3. Low DCR/ μ H.
4. Handles high transient current spikes without saturation.
5. Encapsulated body offers improved environmental protection and moisture resistance.
6. Higher dielectric withstanding voltage.
7. Corrosion resistant package.
8. RoHS Compliance.

Applications

1. PDA/Notebook/Desktop/Server applications high current and low profile power supplier
2. High current POL converters.
3. Battery powered devices.

Shape and Dimension

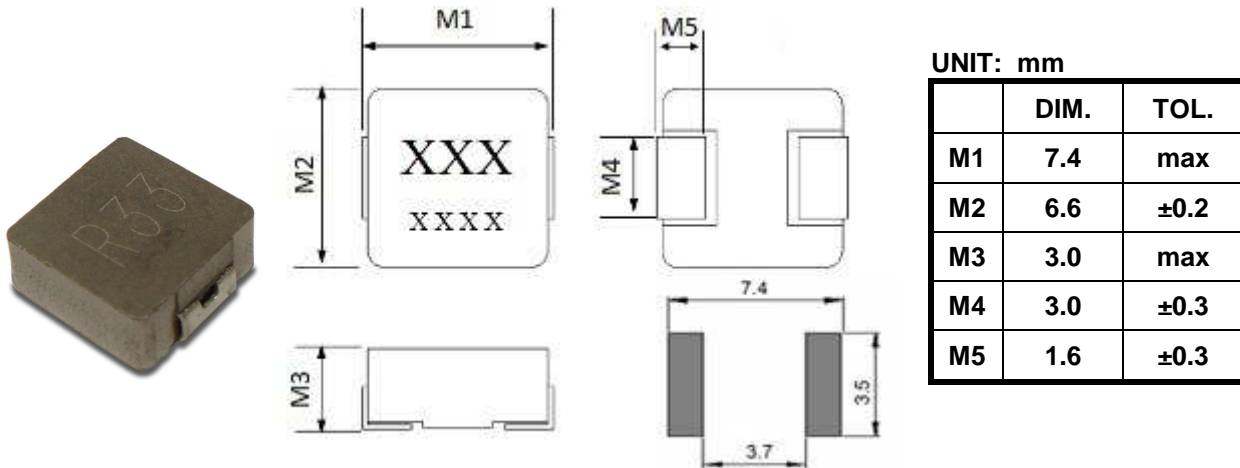

MARKING AND DATE CODE

Marking ex:1.0uH \rightarrow 1R0

Date code

XX XX \rightarrow year and weekly ex:1033

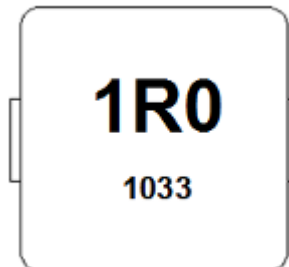

Ordering Information

| WL | PM | 7066 | 30 | M | R22 | L | C |
|--|--|----------------------------------|---------------------------|------------------------------|---|--|----------------------|
| Product Code WL: Inductor | Series SMD Molded power inductor. | Dimensions 7.0 * 6.6mm | Thickness 2.8mm | Tolerance M: ± 20% | Value R22=0.22uH 1R0=1.0uH 100=10uH | Packing Code L=13" Reeled (Embossed tape) | Internal code |

Electrical Characteristics

WLPM706630 series

| Walsin Part Number | L(uH) | Tolerance | Test Frequency | RDC Maximum (mΩ) | | Rated Current Typical (A) | I sat Typical (A) |
|--------------------|-------|-----------|----------------|------------------|------|---------------------------|-------------------|
| | | | | TYP. | MAX. | | |
| WLPM706630MR15LC | 0.15 | M | 100 | 2 | 2.5 | 27 | 45 |
| WLPM706630MR22LC | 0.22 | M | 100 | 2.5 | 2.8 | 23 | 40 |
| WLPM706630MR33LC | 0.33 | M | 100 | 3.5 | 3.9 | 20 | 30 |
| WLPM706630MR47LC | 0.47 | M | 100 | 4 | 4.2 | 17.5 | 26 |
| WLPM706630MR56LC | 0.56 | M | 100 | 4.7 | 5 | 16.5 | 25.5 |
| WLPM706630MR68LC | 0.68 | M | 100 | 5 | 5.5 | 15.5 | 25 |
| WLPM706630MR82LC | 0.82 | M | 100 | 6.7 | 8 | 13 | 20 |
| WLPM706630M1R0LC | 1.0 | M | 100 | 9 | 10 | 11 | 20 |
| WLPM706630M1R5LC | 1.5 | M | 100 | 14 | 15 | 9 | 16 |
| WLPM706630M2R2LC | 2.2 | M | 100 | 17 | 20 | 8 | 12 |
| WLPM706630M3R3LC | 3.3 | M | 100 | 28 | 30 | 6 | 10 |
| WLPM706630M4R7LC | 4.7 | M | 100 | 37 | 40 | 5.5 | 7 |
| WLPM706630M5R6LC | 5.6 | M | 100 | 40 | 44 | 5.5 | 6 |
| WLPM706630M6R8LC | 6.8 | M | 100 | 54 | 60 | 4.5 | 6.5 |
| WLPM706630M8R2LC | 8.2 | M | 100 | 54 | 60 | 4.5 | 6 |
| WLPM706630M100LC | 10 | M | 100 | 62 | 68 | 4 | 5.5 |

TEST INSTRUMENT: CHROMA 16502、Zentech1320+Zentech3305

- (1). Test Freq : 100KHz , 1.0V
- (2). All test data is referenced to 25°C ambient.
- (3). Operating Temperature Range -55°C to +125°C .
- (4). Rated Current: DC current(A)that will cause an approximateΔT of 40°C .
- (5). I sat: DC current(A)that will cause Lo to drop approximately 30%.
- (6). The part temperature(ambient +temp rise)should not exceed 125°C under worst case operating conditions. Circuit design, component placement, PWB trace size and thickness, airflow and other cooling provisions all affect the part temperature Part temperature should be verified

Electrical Curve

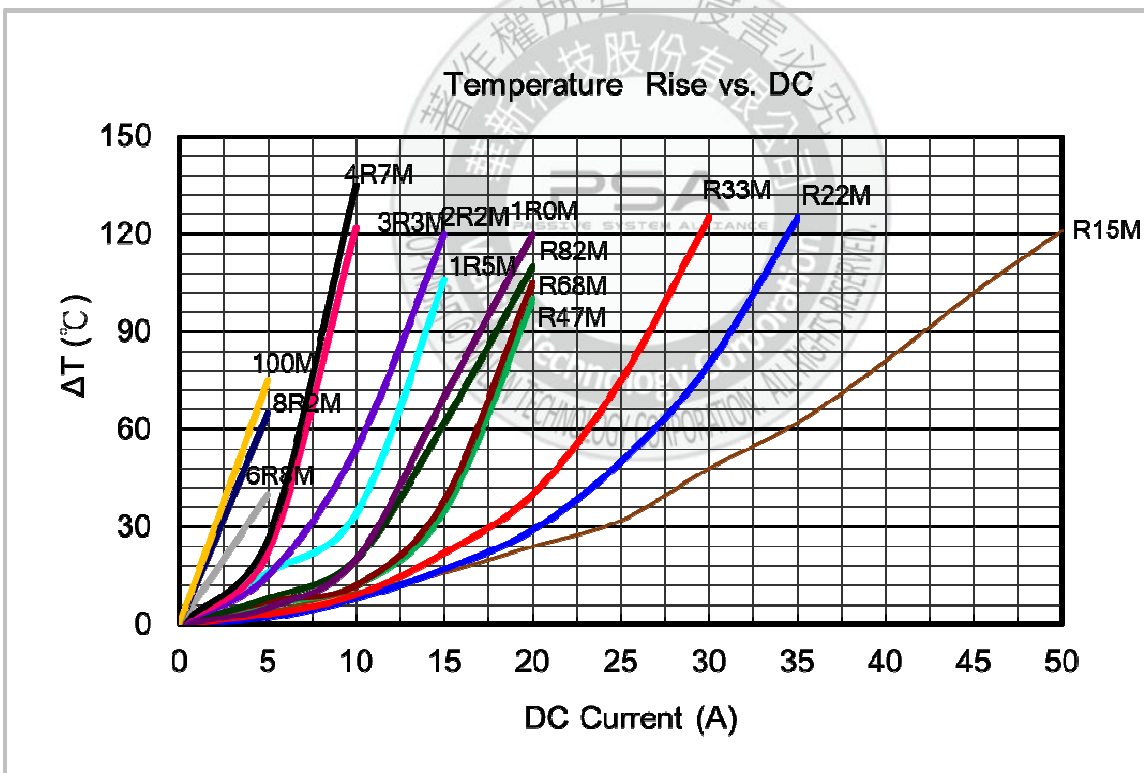
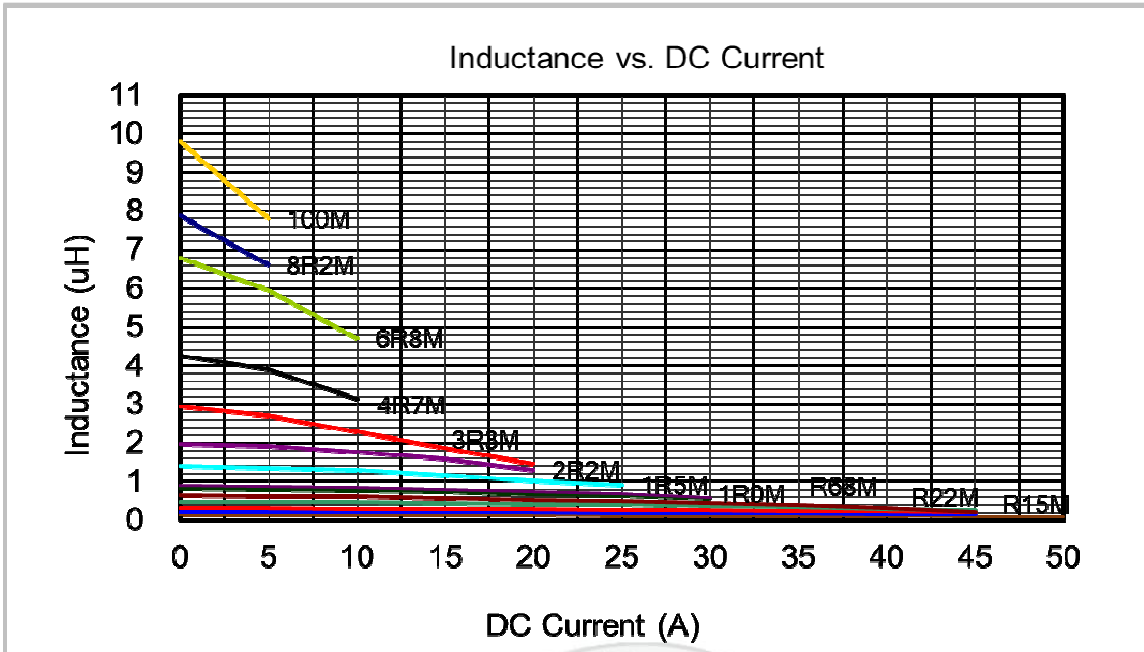

RELIABILITY PERFORMANCE

Reliability Experiment For Electrical

| Test Item | Test Condition | Standard Source |
|-----------------------|--|---|
| Humidity Test | +40°C ± 2°C, humidity of 90% ± 5% (total 96 hours). | MIL-STD-202G Method 103B Test Condition B |
| High Temperature Test | 1. Temperature: +125°C ± 2°C 2. Test time: 48 ± 2hrs | IEC 68-2 Test Condition B |
| Low Temperature Test | 1. Temperature: -40°C ± 2°C 2. Test time: 48 ± 2hrs | IEC 68-2 Test Condition A |
| Thermal Shock | +125°C ± 5°C (30 minutes) ~ -40 ± 5°C (30 minutes), temperature switch time: 5 minutes (total 50 cycles). | MIL-STD-202G Method 107G Test Condition B-2 |
| Life Test | +70°C ± 5°C (250Hours) | MIL-STD-202G Method 108A Test Condition B |

Reliability Experiment For Physical

| Test Item | Test Condition | Standard Source |
|-----------------------------|--|--|
| Vibration Test | 10-55-10HZ, amplitude: 1.5mm, direction: X, Y, Z axes, each axis 2 hours (total 6 hours). | MIL-STD-202G Method 201A |
| Solder Heat Resistance Test | IR/convection reflow: Peak Temp 250 ± 5°C for 5Sec in air, Through 2 Cycle. Temperature Ramp: +1 ~ 4°C/sec; Above 183°C, must keep 90 s - 120 s | MIL-STD-202G Method 210F Test Condition (Reflow) |
| Solder Ability Test | Soak in 245 °C solder pot of 3Sec, PAD must have 95% above coverage. | J-STD-003B |

TYPICAL RoHS REFLOW PROFILE

Typical RoHS Reflow Profile

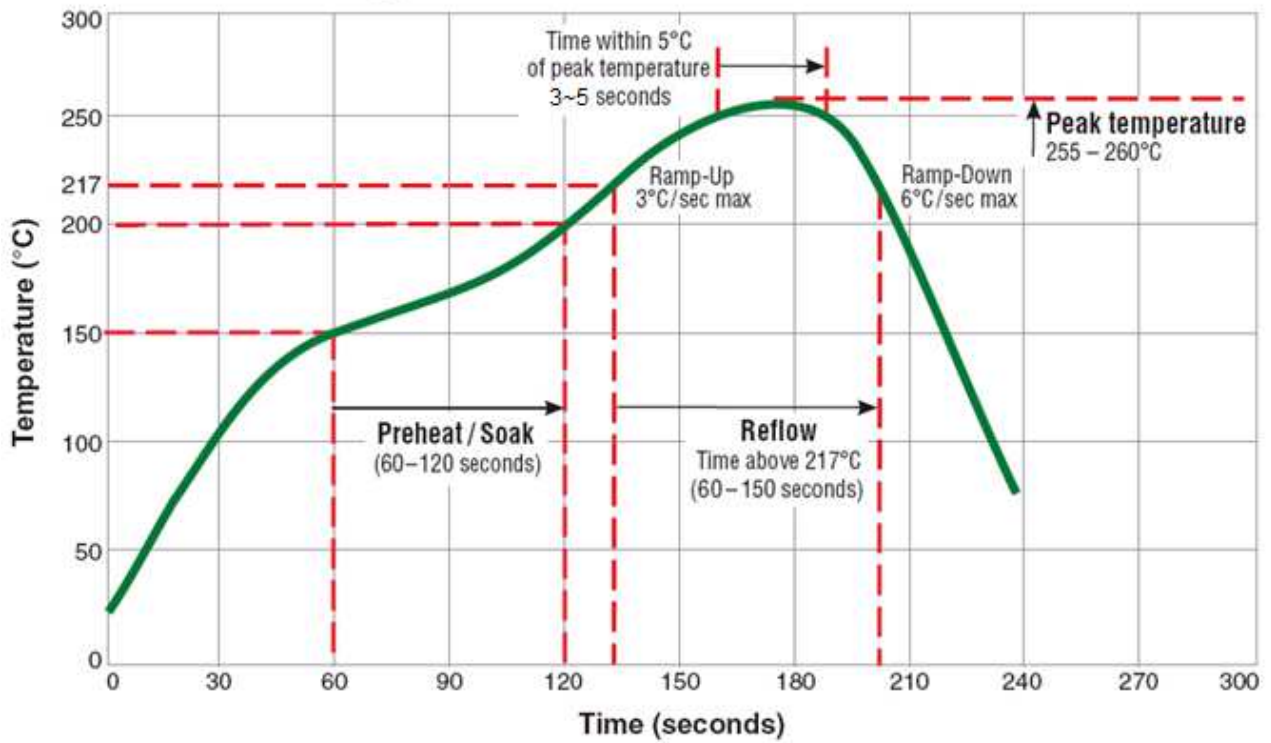

Packaging

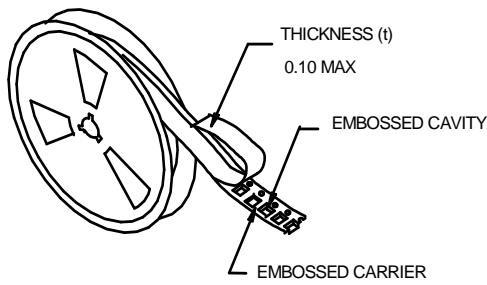

THE FORCE FOR TEARING OFF 130 GRAMS IN THE ARROW

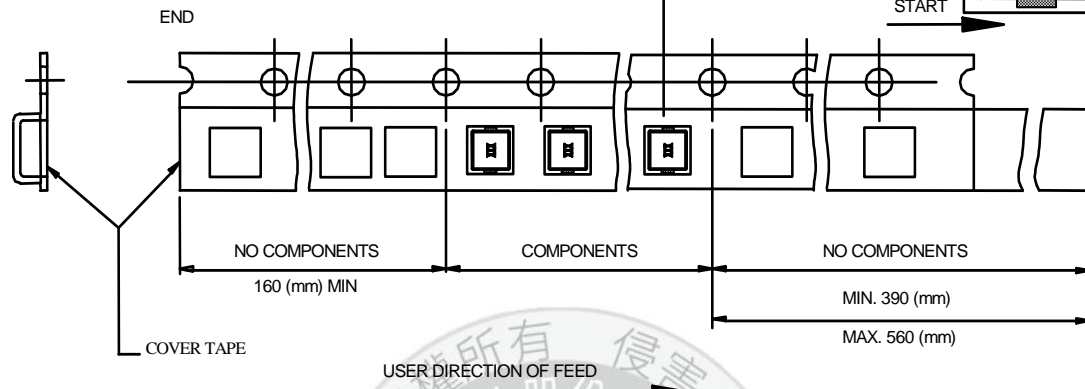
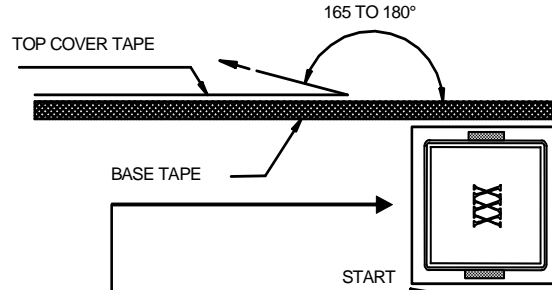

■ CARRIER TAPE REELS (mm)

MATERIAL: PLASTIC

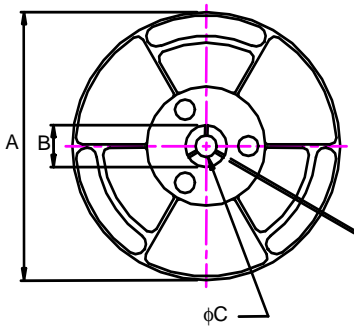

■ DIMENSIONS OF CARRIER TAPE (mm)

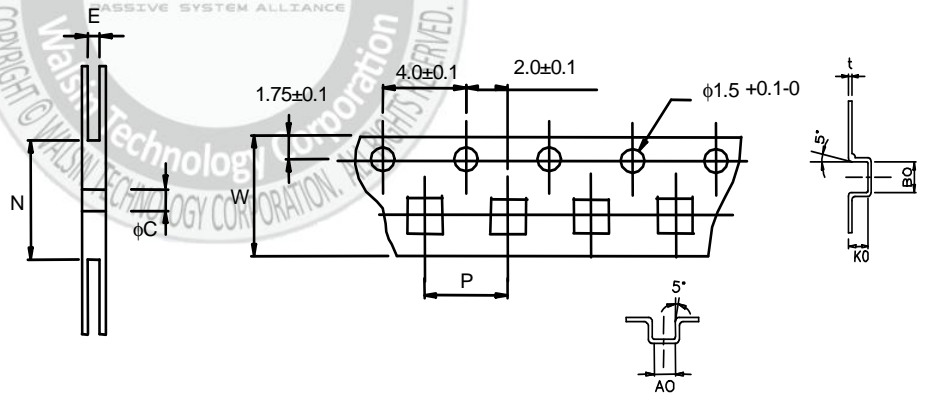

※ 10 sprocket hole pitch cumulative tolerance ± 0.20

UNIT : mm

| | A | B | C | E | N | P | W | t | A0 | B0 | K0 |
|------|-----------|-----------|-----------|-----------|-----|-----------|-----------|------------|-----------|-----------|-----------|
| DIM. | 330 | 25.0 | 13.0 | 16.6 | 100 | 12.0 | 16.0 | 0.4 | 6.9 | 7.6 | 3.4 |
| TOL. | ± 0.2 | ± 0.5 | ± 0.5 | ± 0.5 | MIN | ± 0.1 | ± 0.3 | ± 0.05 | ± 0.1 | ± 0.1 | ± 0.1 |

Quantity per reel : 1K pcs