

HiPerFET™ Power MOSFETs Q-Class

IXFH 30N60Q
IXFT 30N60Q

V_{DSS} = 600 V
I_{D25} = 30 A
R_{DS(on)} = 0.23 Ω

N-Channel Enhancement Mode
Avalanche Rated, High dv/dt, Low Q_g

Preliminary Data Sheet

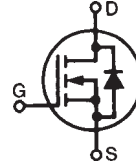

t_{rr} ≤ 250 ns

Symbol	Test Conditions	Maximum Ratings	
V _{DSS}	T _J = 25°C to 150°C	600	V
V _{DGR}	T _J = 25°C to 150°C; R _{GS} = 1 MΩ	600	V
V _{GS}	Continuous	±20	V
V _{GSM}	Transient	±30	V
I _{D25}	T _C = 25°C	30	A
I _{DM}	T _C = 25°C, pulse width limited by T _{JM}	120	A
I _{AR}	T _C = 25°C	30	A
E _{AR}	T _C = 25°C	45	mJ
E _{AS}	T _C = 25°C	1.5	J
dv/dt	I _S ≤ I _{DM} , di/dt ≤ 100 A/μs, V _{DD} ≤ V _{DSS} , T _J ≤ 150°C, R _G = 2 Ω	10	V/ns
P _D	T _C = 25°C	500	W
T _J		-55 ... +150	°C
T _{JM}		150	°C
T _{stg}		-55 ... +150	°C
T _L	1.6 mm (0.063 in) from case for 10 s	300	°C
M _d	Mounting torque	TO-247	1.13/10 Nm/lb.in.
Weight		TO-247	6 g
		TO-268	4 g

TO-247 AD (IXFH)

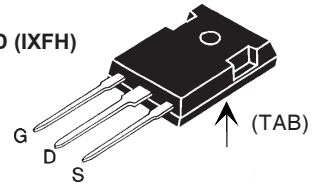

TO-268 (D3) (IXFT)

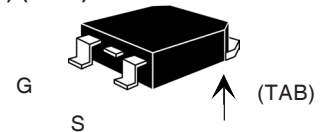

G = Gate
S = Source

D = Drain
TAB = Drain

Features

- Low gate charge
- International standard packages
- Epoxy meet UL 94 V-0, flammability classification
- Low R_{DS(on)} HDMOS™ process
- Rugged polysilicon gate cell structure
- Avalanche energy and current rated
- Fast intrinsic Rectifier

Advantages

- Easy to mount
- Space savings
- High power density

Symbol	Test Conditions	Characteristic Values (T _J = 25°C, unless otherwise specified)		
		min.	typ.	max.
V _{DSS}	V _{GS} = 0 V, I _D = 250μA Temperature Coefficient	600	0.095	V %/K
V _{GS(th)}	V _{DS} = V _{GS} , I _D = 4 mA Temperature Coefficient	2.5	- 0.24	V %/K
I _{GSS}	V _{GS} = ±20 V _{DC} , V _{DS} = 0			±200 nA
I _{DSS}	V _{DS} = V _{DSS} , T _J = 25°C V _{GS} = 0 V, T _J = 125°C			25 μA 1 mA
R _{DS(on)}	V _{GS} = 10 V, I _D = 0.5 • I _{D25} Pulse test, t ≤ 300 μs, duty cycle d ≤ 2 %			0.23 Ω

Symbol	Test Conditions	Characteristic Values ($T_J = 25^\circ\text{C}$, unless otherwise specified)		
		min.	typ.	max.
g_{fs}	$V_{DS} = 10\text{ V}; I_D = 0.5 \cdot I_{D25}$, pulse test	14	22	S
C_{iss}	$V_{GS} = 0\text{ V}, V_{DS} = 25\text{ V}, f = 1\text{ MHz}$		4700	pF
C_{oss}			580	pF
C_{rss}			230	pF
$t_{d(on)}$	$V_{GS} = 10\text{ V}, V_{DS} = 0.5 \cdot V_{DSS}, I_D = 0.5 \cdot I_{D25}$ $R_G = 2.0\ \Omega$ (External),		30	ns
t_r			32	ns
$t_{d(off)}$			80	ns
t_f			16	ns
$Q_{g(on)}$	$V_{GS} = 10\text{ V}, V_{DS} = 0.5 \cdot V_{DSS}, I_D = 0.5 \cdot I_{D25}$		125	nC
Q_{gs}			28	nC
Q_{gd}			76	nC
R_{thJC}	TO-247			0.25 K/W
R_{thCK}			0.25	K/W

TO-247 AD (IXFH) Outline

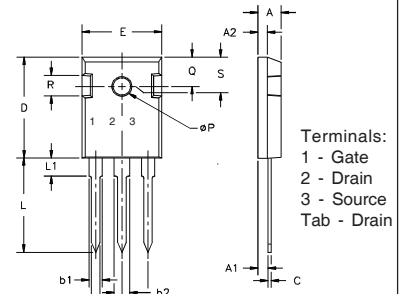

Terminals:
1 - Gate
2 - Drain
3 - Source
Tab - Drain

Dim.	Millimeter		Inches	
	Min.	Max.	Min.	Max.
A	4.7	5.3	.185	.209
A ₁	2.2	2.54	.087	.102
A ₂	2.2	2.6	.059	.098
b	1.0	1.4	.040	.055
b ₁	1.65	2.13	.065	.084
b ₂	2.87	3.12	.113	.123
C	.4	.8	.016	.031
D	20.80	21.46	.819	.845
E	15.75	16.26	.610	.640
e	5.20	5.72	0.205	0.225
L	19.81	20.32	.780	.800
L ₁		4.50		.177
∅P	3.55	3.65	.140	.144
Q	5.89	6.40	0.232	0.252
R	4.32	5.49	.170	.216
S	6.15	BSC	242	BSC

Source-Drain Diode

Symbol	Test Conditions	Characteristic Values ($T_J = 25^\circ\text{C}$, unless otherwise specified)		
		min.	typ.	max.
I_S	$V_{GS} = 0\text{ V}$			26 A
I_{SM}	Repetitive; pulse width limited by T_{JM}			104 A
V_{SD}	$I_F = I_S, V_{GS} = 0\text{ V}$, Pulse test, $t \leq 300\ \mu\text{s}$, duty cycle $d \leq 2\%$			1.5 V
t_{rr}	$I_F = I_S - di/dt = 100\text{ A}/\mu\text{s}, V_R = 100\text{ V}$		1	250 ns
Q_{RM}			10	μC
I_{RM}				A

TO-268 Outline

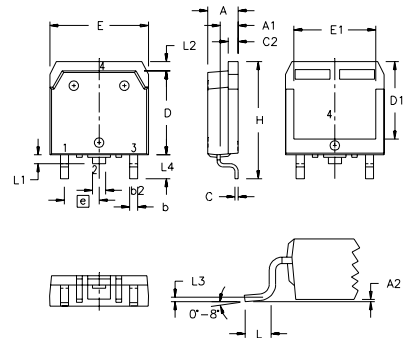

Terminals:
1 - Gate
2 - Drain
3 - Source
Tab - Drain

SYM	INCHES		MILLIMETERS	
	MIN	MAX	MIN	MAX
A	.193	.201	4.90	5.10
A ₁	.106	.114	2.70	2.90
A ₂	.001	.010	0.02	0.25
b	.045	.057	1.15	1.45
b ₂	.075	.083	1.90	2.10
C	.016	.026	0.40	0.65
C ₂	.057	.063	1.45	1.60
D	.543	.551	13.80	14.00
D ₁	.488	.500	12.40	12.70
E	.624	.632	15.85	16.05
E ₁	.524	.535	13.30	13.60
e	.215	BSC	5.45	BSC
H	.736	.752	18.70	19.10
L	.094	.106	2.40	2.70
L ₁	.047	.055	1.20	1.40
L ₂	.039	.045	1.00	1.15
L ₃	.010	BSC	0.25	BSC
L ₄	.150	.161	3.80	4.10

IXYS reserves the right to change limits, test conditions, and dimensions.

Fig. 1. Output Characteristics
@ 25 Deg. C

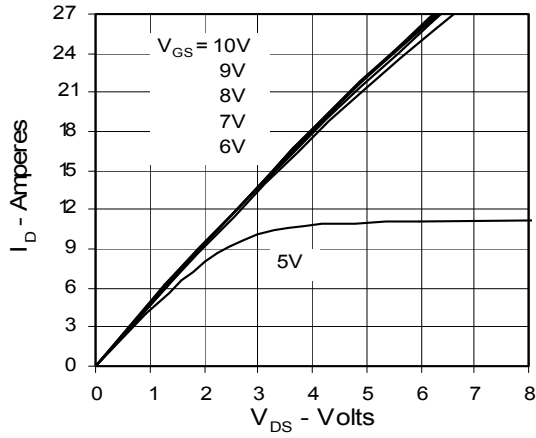

Fig. 2. Extended Output Characteristics
@ 25 deg. C

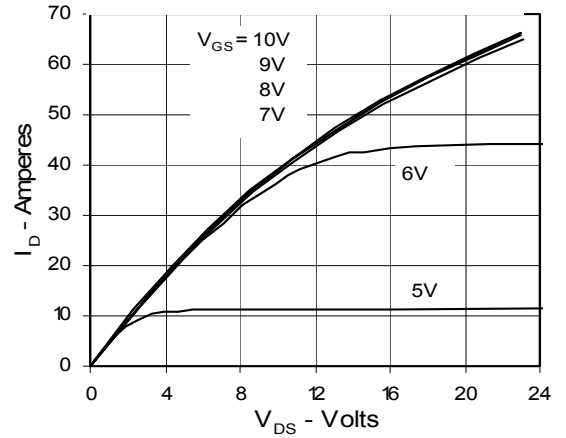

Fig. 3. Output Characteristics
@ 125 Deg. C

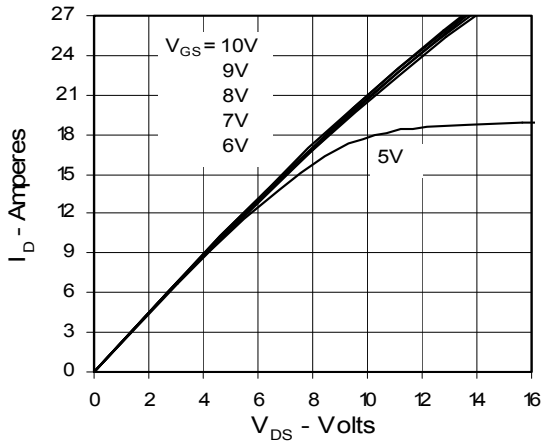

Fig. 4. $R_{DS(on)}$ Normalized to I_{D25} Value vs. Junction Temperature

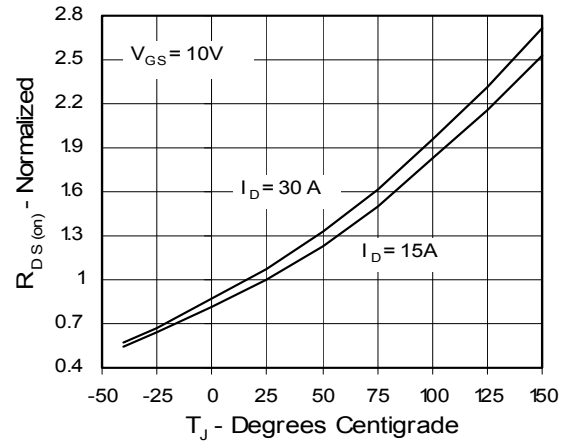

Fig. 5. $R_{DS(on)}$ Normalized to I_{D25} Value vs. I_D

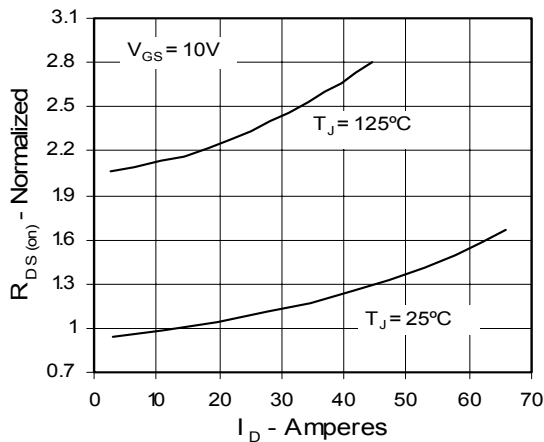

Fig. 6. Drain Current vs. Case Temperature

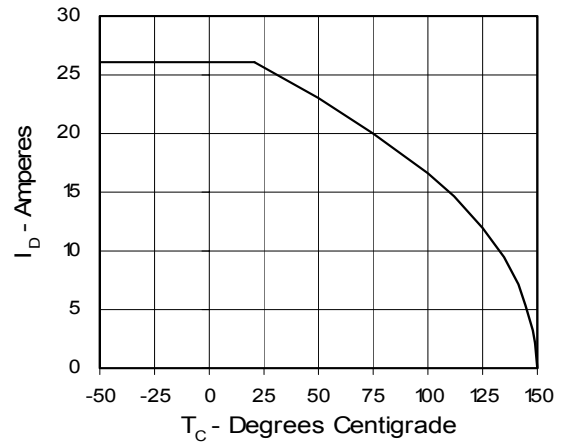

Fig. 7. Input Admittance

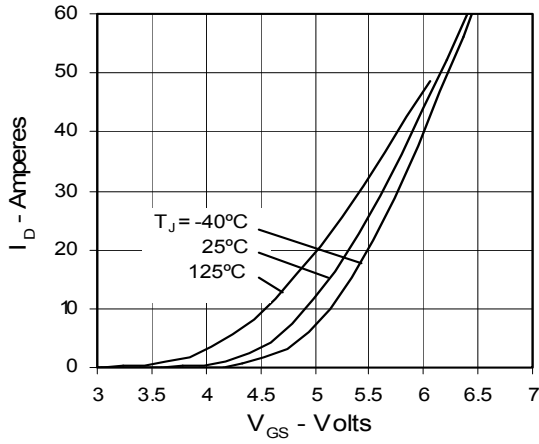

Fig. 8. Transconductance

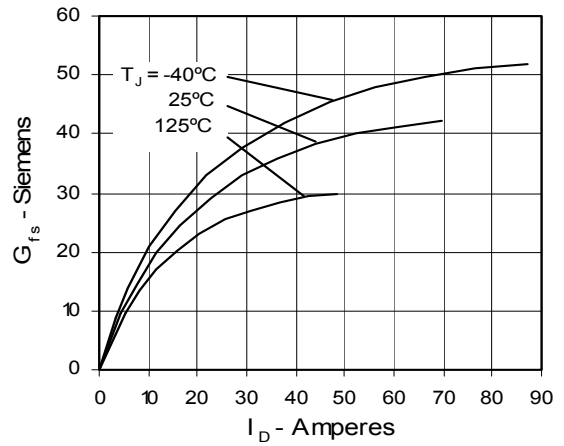

Fig. 9. Source Current vs. Source-To-Drain Voltage

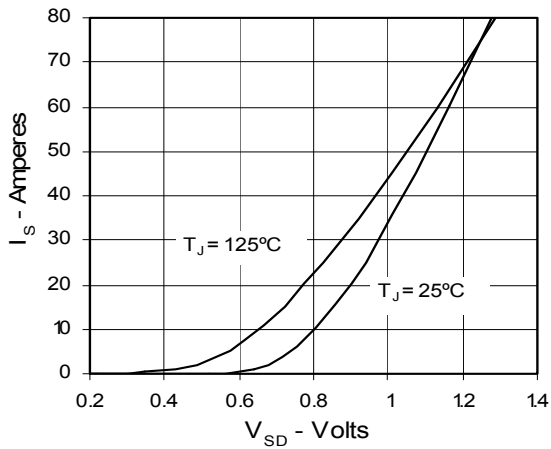

Fig. 10. Gate Charge

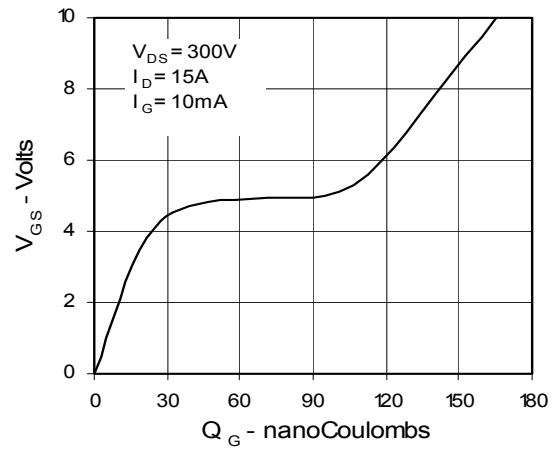

Fig. 11. Capacitance

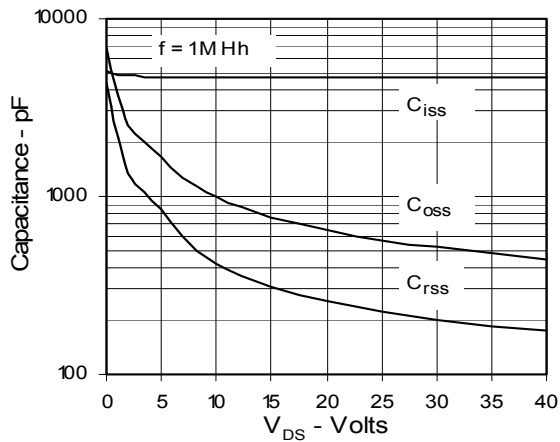
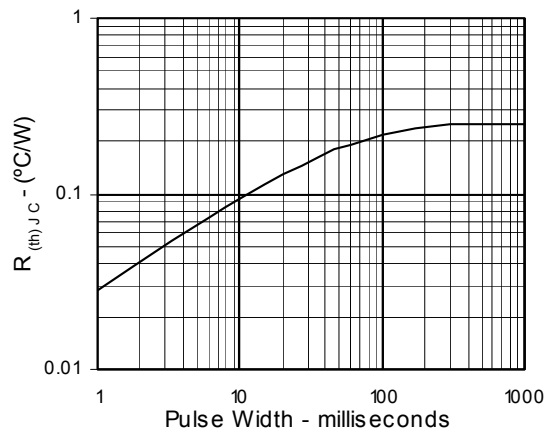

Fig. 12. Maximum Transient Thermal Resistance



IXYS reserves the right to change limits, test conditions, and dimensions.

IXYS MOSFETs and IGBTs are covered by one or more of the following U.S. patents:

4,835,592 4,881,106 5,017,508 5,049,961 5,187,117 5,486,715 6,306,728B1 6,259,123B1 6,306,728B1
4,850,072 4,931,844 5,034,796 5,063,307 5,237,481 5,381,025 6,404,065B1 6,162,665 6,534,343