



## GaAs MMIC SUB-HARMONIC UPCONVERTER, 17.7 - 23.6 GHz

### Typical Applications

The HMC711LC5 is ideal for:

- Point-to-Point & Point-to-Multi-Point Radio
- Military Radar, EW & ELINT
- Satellite Communications

### Features

- Conversion Gain: 15 dB
- 2 LO to RF Isolation: 10 dB
- High Output IP3: 28 dBm
- High Output P1dB: 17 dBm
- 32 Lead Ceramic 5x5mm SMT Package: 25mm<sup>2</sup>

### Functional Diagram

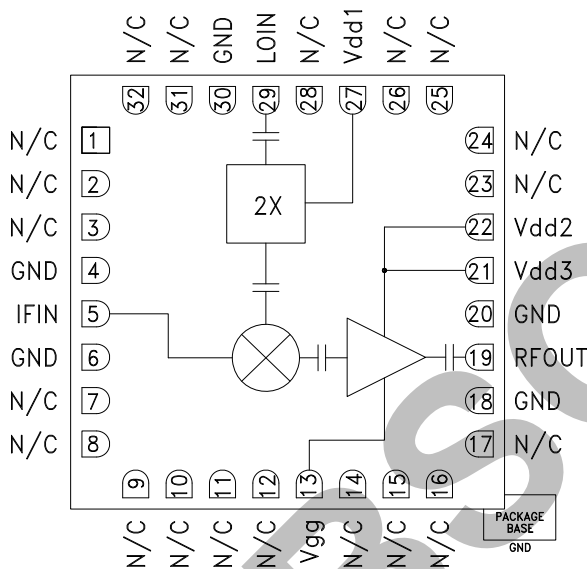

### General Description

The HMC711LC5 is a GaAs MMIC sub-harmonic upconverter in a leadless RoHS compliant QFN SMT ceramic package. This compact upconverter provides a small signal conversion gain of 15 dB and wide IF bandwidth of DC - 3.5 GHz. The HMC711LC5 utilizes a mixer which is driven by an active x2 multiplier and followed by a high linearity amplifier. The HMC711LC5 is a much smaller alternative to hybrid style subharmonic upconverter assemblies and it eliminates the need for wire bonding by allowing the use of surface mount manufacturing techniques.

### Electrical Specifications, IF = 1900 MHz, LO = +4 dBm, Vdd1, Vdd2, Vdd3 = +5V [1][2]

Parameter	Min.	Typ.	Max.	Units
Frequency Range, RF		17.7 - 23.6		GHz
Frequency Range, LO		9.5 - 13.6		GHz
Frequency Range, IF		DC - 3.5		GHz
Conversion Gain	10	15		dB
1 dB Compression (Output)		17		dBm
2 LO to RF Isolation		10		dB
2 LO to IF Isolation		25		dB
IP3 (Output)		28		dBm
Supply Current Idd1		80		mA
Supply Current (Idd2 + Idd3) [2]		240		mA

[1] Unless otherwise noted all measurements performed with high side LO, IF = 1900 MHz.

[2] Adjust Vgg between -2 to 0V to achieve Idd = 240mA typical.



**GaAs MMIC SUB-HARMONIC UPCONVERTER, 17.7 - 23.6 GHz**

**Data Taken as an Upconverter, IF = 1900 MHz**

**Conversion Gain, LSB vs. Temperature**

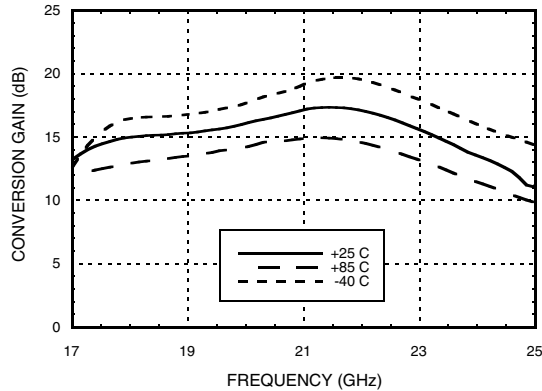

**Conversion Gain, LSB vs. LO Drive**

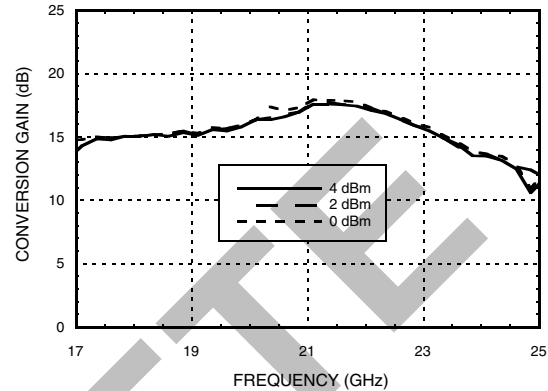

**Conversion Gain, LSB vs. Vdd**

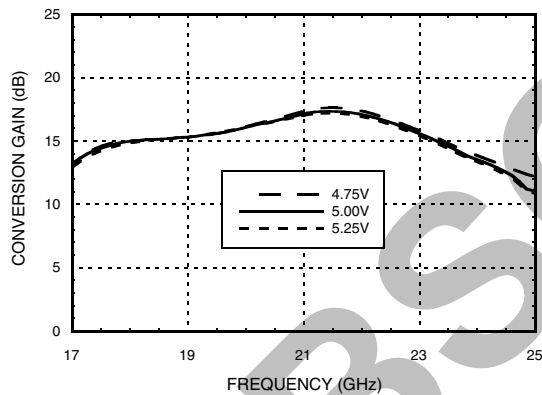

**RF Return Loss vs. Temperature**

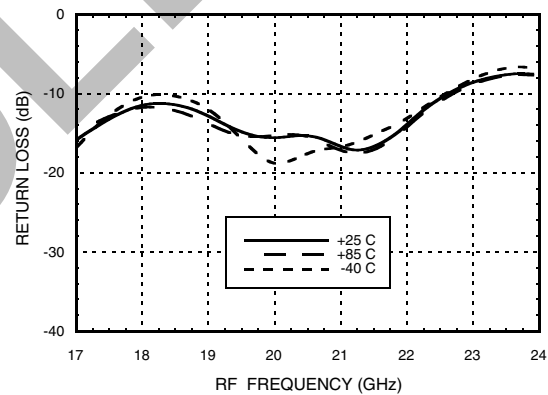

**LO Return Loss vs. Temperature**

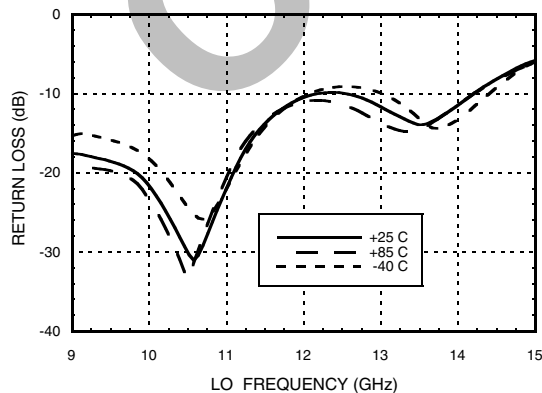

**IF Return Loss**

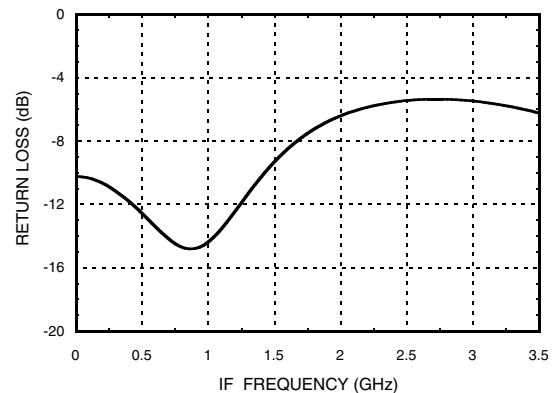



**GaAs MMIC SUB-HARMONIC UPCONVERTER, 17.7 - 23.6 GHz**

*Data Taken as an Upconverter, IF = 1900 MHz*

**Input P1dB, LSB vs. Temperature**

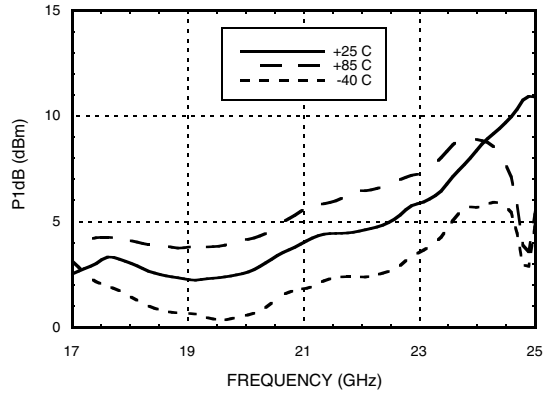

**Output P1dB, LSB vs. Temperature**

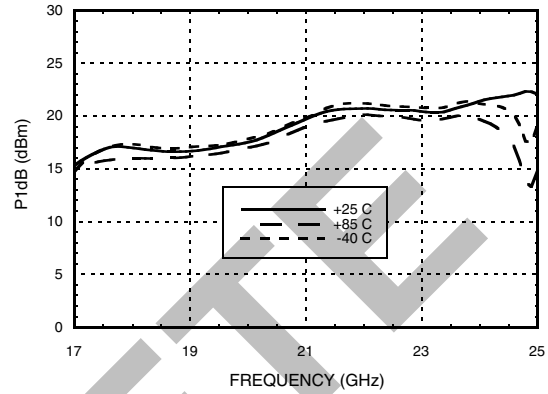

**Input IP3, LSB vs. Temperature**

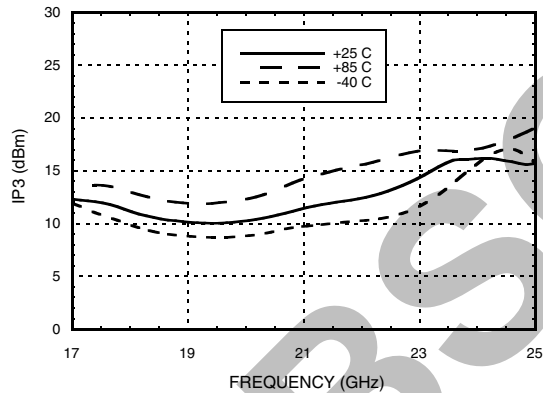

**Output IP3, LSB vs. Temperature**

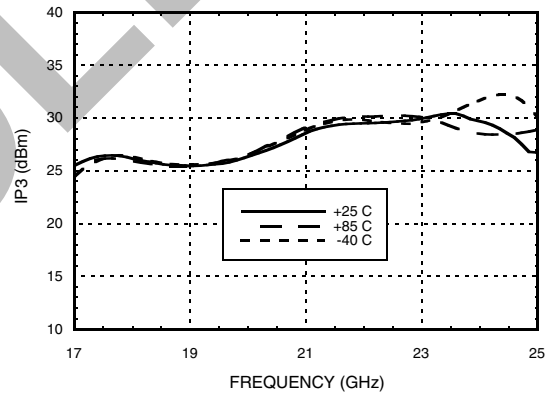

**Input IP3, LSB vs. LO Drive**

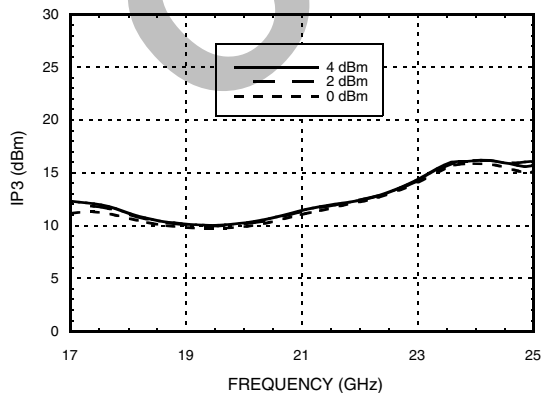

**Output IP3, LSB vs. LO Drive**

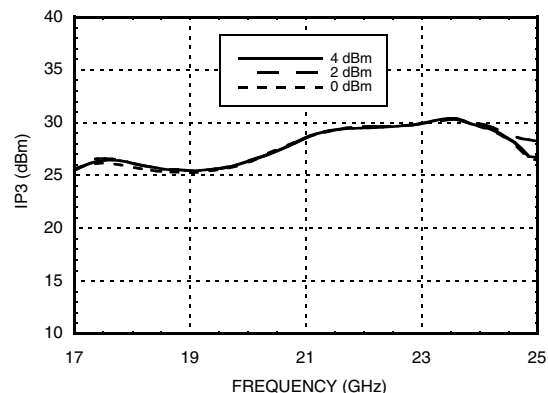

Information furnished by Analog Devices is believed to be accurate and reliable. However, no responsibility is assumed by Analog Devices for its use, nor for any infringements of patents or other rights of third parties that may result from its use. Specifications subject to change without notice. No license is granted by implication or otherwise under any patent or patent rights of Analog Devices. Trademarks and registered trademarks are the property of their respective owners.

For price, delivery, and to place orders: Analog Devices, Inc., One Technology Way, P.O. Box 9106, Norwood, MA 02062-9106 Phone: 781-329-4700 • Order online at [www.analog.com](http://www.analog.com) Application Support: Phone: 1-800-ANALOG-D



**GaAs MMIC SUB-HARMONIC  
UPCONVERTER, 17.7 - 23.6 GHz**

**Data Taken as an Upconverter, IF = 1900 MHz**

**Input IP3, LSB vs. Vdd**

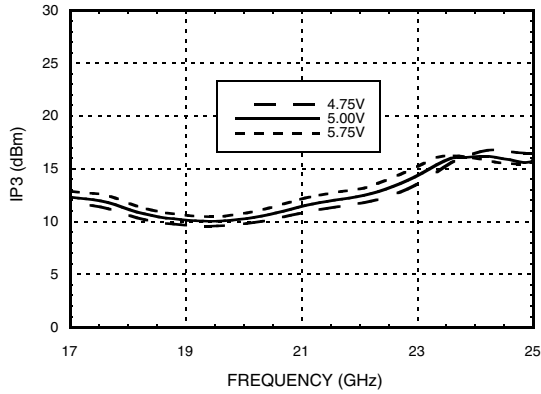

**Output IP3, LSB vs. Vdd**

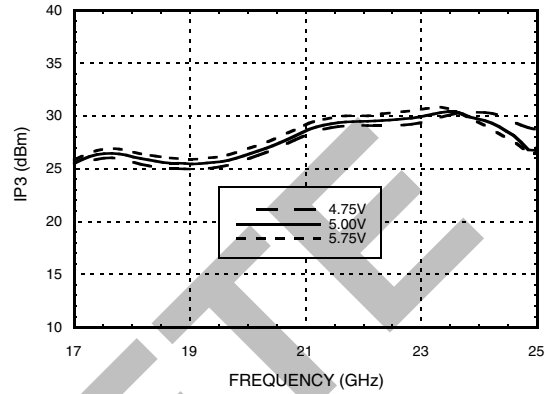

**Isolations with 2LO**

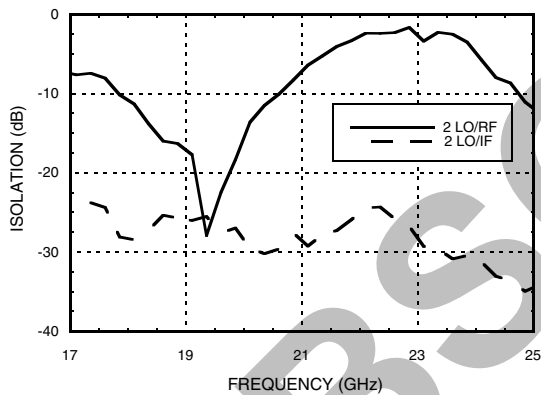

**Isolations with LO**

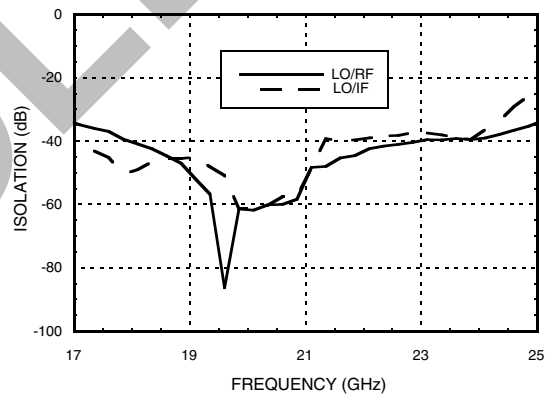



**GaAs MMIC SUB-HARMONIC UPCONVERTER, 17.7 - 23.6 GHz**

**Data Taken as an Upconverter, IF = 2900 MHz**

**Conversion Gain, LSB vs. Temperature**

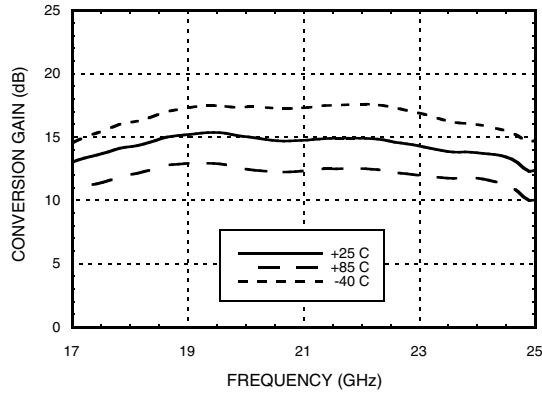

**Conversion Gain, LSB vs. LO Drive**

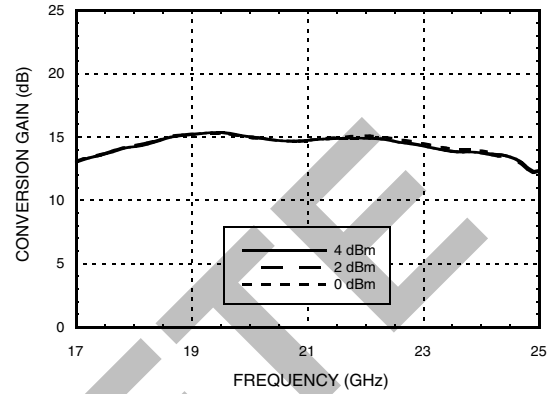

**Conversion Gain, LSB vs. Vdd**

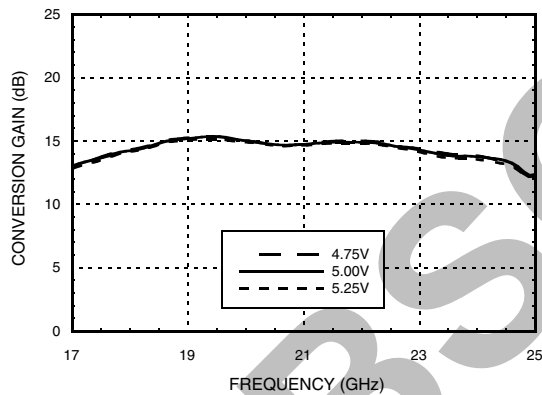

**Input IP3, LSB vs. Temperature**

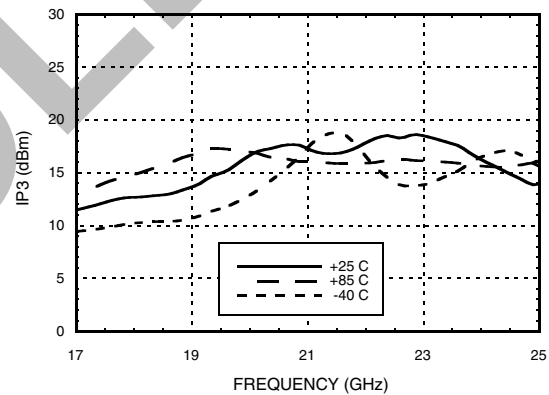

**Output IP3, LSB vs. Temperature**

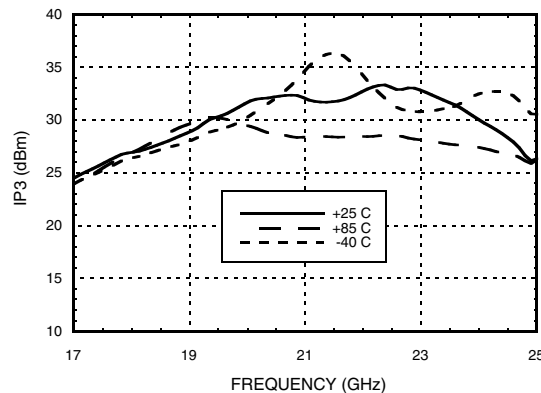

Information furnished by Analog Devices is believed to be accurate and reliable. However, no responsibility is assumed by Analog Devices for its use, nor for any infringements of patents or other rights of third parties that may result from its use. Specifications subject to change without notice. No license is granted by implication or otherwise under any patent or patent rights of Analog Devices. Trademarks and registered trademarks are the property of their respective owners.

For price, delivery, and to place orders: Analog Devices, Inc., One Technology Way, P.O. Box 9106, Norwood, MA 02062-9106 Phone: 781-329-4700 • Order online at [www.analog.com](http://www.analog.com) Application Support: Phone: 1-800-ANALOG-D



**GaAs MMIC SUB-HARMONIC UPCONVERTER, 17.7 - 23.6 GHz**

*Data Taken as an Upconverter, IF = 1900 MHz*

**Conversion Gain, USB vs. Temperature**

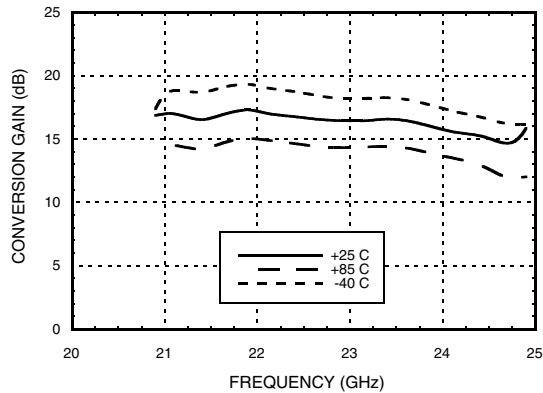

**Conversion Gain, USB vs. LO Drive**

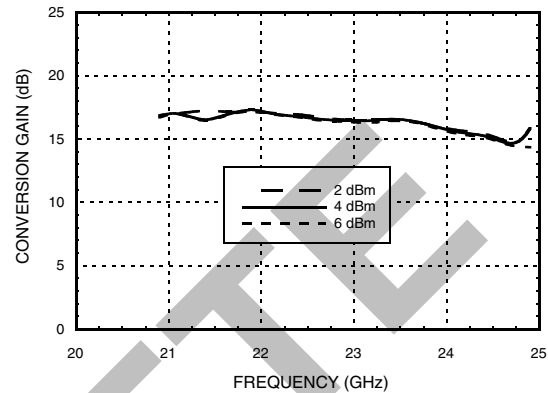

**Conversion Gain, USB vs. Vdd**

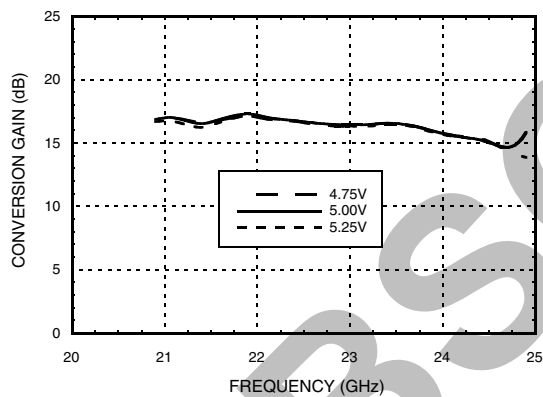

**Input P1dB, USB vs. Temperature**

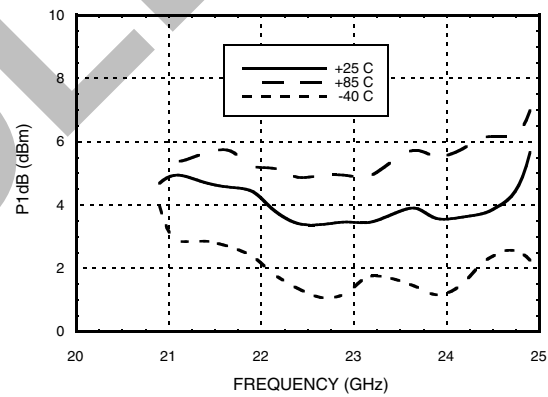

**Output P1dB, USB vs. Temperature**

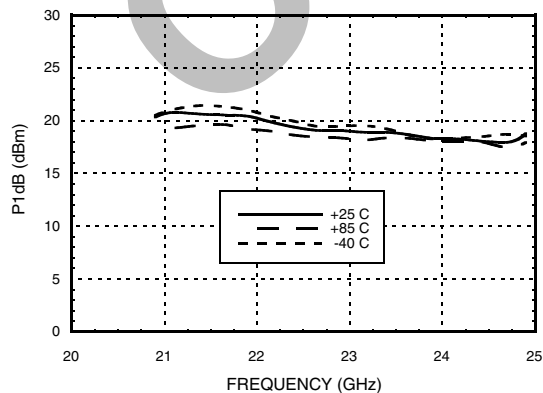

**Input IP3, USB vs. Temperature**

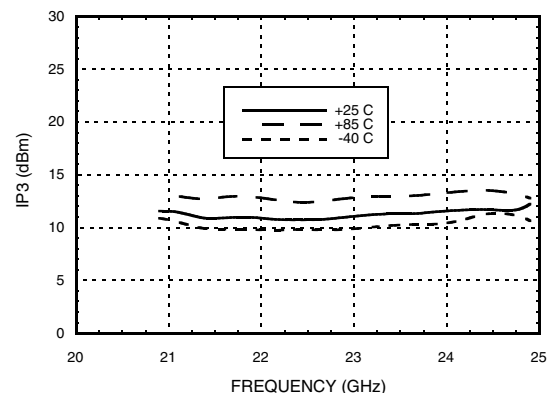

Information furnished by Analog Devices is believed to be accurate and reliable. However, no responsibility is assumed by Analog Devices for its use, nor for any infringements of patents or other rights of third parties that may result from its use. Specifications subject to change without notice. No license is granted by implication or otherwise under any patent or patent rights of Analog Devices. Trademarks and registered trademarks are the property of their respective owners.

For price, delivery, and to place orders: Analog Devices, Inc., One Technology Way, P.O. Box 9106, Norwood, MA 02062-9106 Phone: 781-329-4700 • Order online at [www.analog.com](http://www.analog.com) Application Support: Phone: 1-800-ANALOG-D



**GaAs MMIC SUB-HARMONIC  
UPCONVERTER, 17.7 - 23.6 GHz**

**Data Taken as an Upconverter, IF = 1900 GHz**

**Input IP3, USB vs. Temperature**

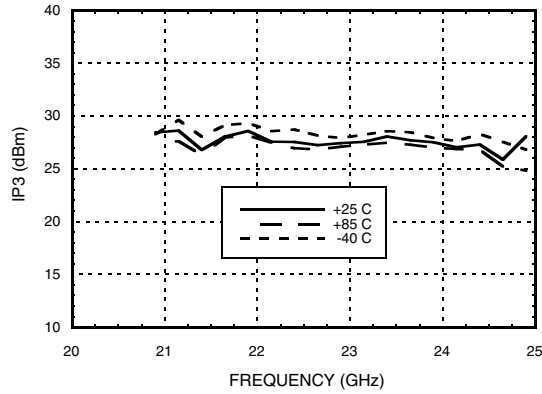

**Input IP3, USB vs. LO Drive**

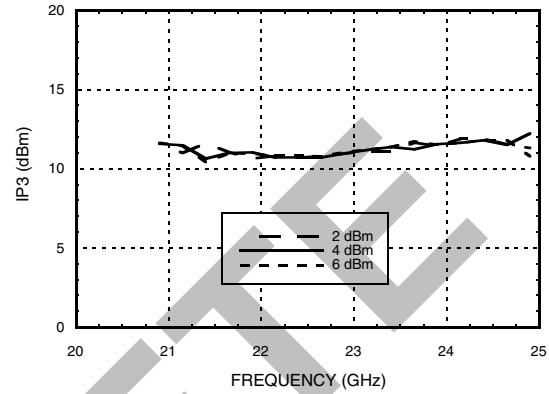

**Output IP3, USB vs. Temperature**

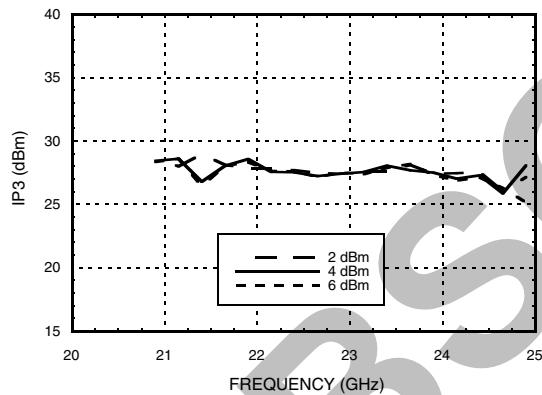

**Input IP3, USB vs. Vdd**

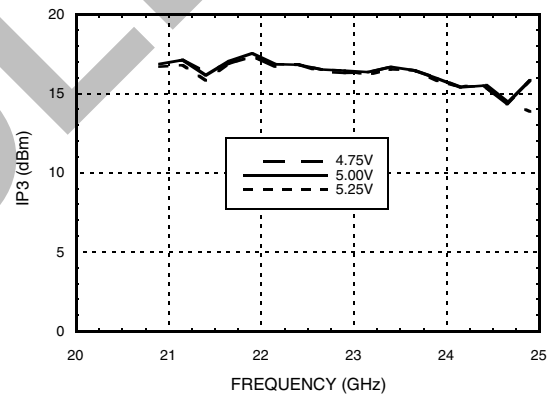

**Output IP3, USB vs. Vdd**

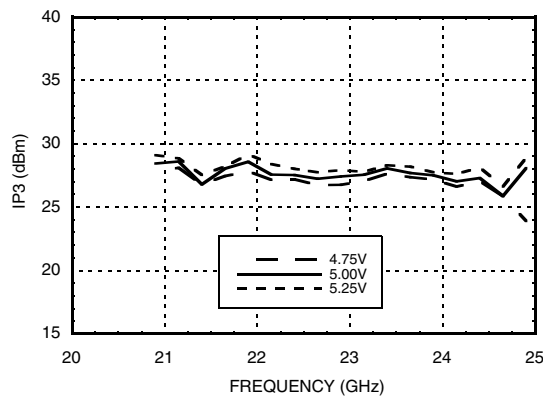



**GaAs MMIC SUB-HARMONIC UPCONVERTER, 17.7 - 23.6 GHz**

**Data Taken as an Upconverter, IF = 3350 MHz**

**Conversion Gain, USB vs. Temperature**

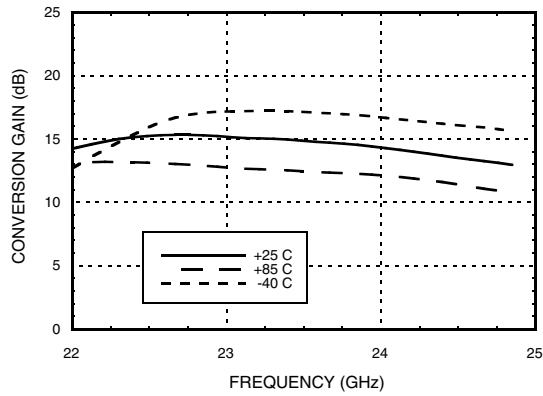

**Conversion Gain, USB vs. LO Drive**

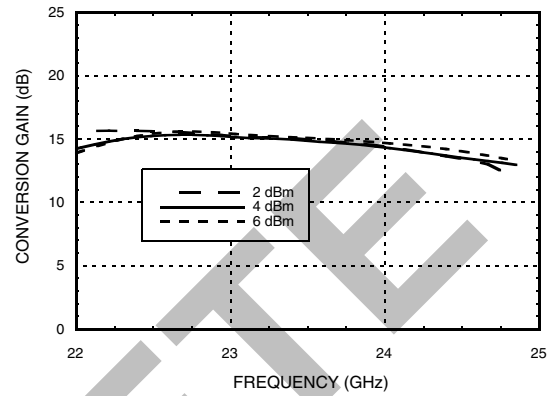

**Conversion Gain, USB vs. Vdd**

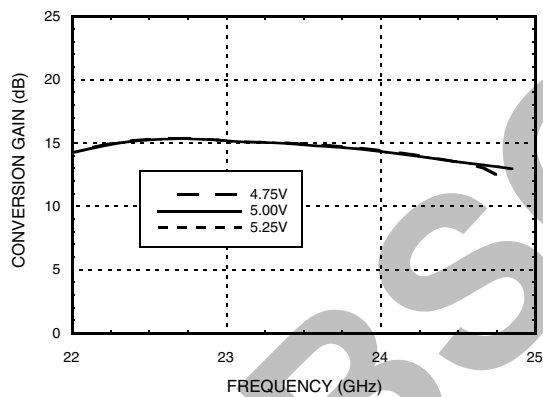

**Input IP3, USB vs. Temperature**

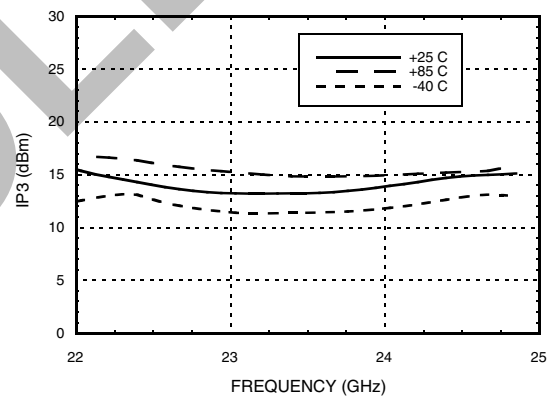

**Output IP3, USB vs. Temperature**

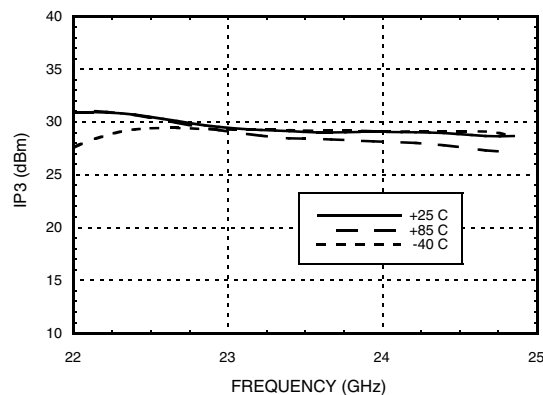

Information furnished by Analog Devices is believed to be accurate and reliable. However, no responsibility is assumed by Analog Devices for its use, nor for any infringements of patents or other rights of third parties that may result from its use. Specifications subject to change without notice. No license is granted by implication or otherwise under any patent or patent rights of Analog Devices. Trademarks and registered trademarks are the property of their respective owners.

For price, delivery, and to place orders: Analog Devices, Inc., One Technology Way, P.O. Box 9106, Norwood, MA 02062-9106 Phone: 781-329-4700 • Order online at [www.analog.com](http://www.analog.com) Application Support: Phone: 1-800-ANALOG-D





## GaAs MMIC SUB-HARMONIC UPCONVERTER, 17.7 - 23.6 GHz

### MxN Spurious Outputs [1]

mIF	nLO				
	0	1	2	3	4
0	x	-60.52	-8.80	-24.52	-45.52
+1	-65.52	-46.52	0.00	-44.52	-56.52
+2	-60.52	-55.52	-56.52	-72.52	-54.52
+3	-79.52	-50.52	-47.52	-48.52	-79.52
+4	-72.52	-2.53	-25.52	-50.52	-74.52

IF = 1.9 GHz @ -10 dBm  
LO = 9.5 GHz @ 4 dBm

### MxN Spurious Outputs [1]

mIF	nLO				
	0	1	2	3	4
0	x	-58	-10.3	-39	-47
+1	-64	-49	0	-62	-60
+2	-61	-60	-53	-80	-62
+3	-100	-80	-53	-99	-104
+4	-97	-90	-96	NM	-108

IF = 1.9 GHz @ -10 dBm  
LO = 10 GHz @ 4 dBm

### MxN Spurious Outputs [1]

mIF	nLO				
	0	1	2	3	4
0	x	-58.8	-13.8	-45.8	-50.8
+1	-69.8	-47.8	0	-75.8	-68.8
+2	-63.8	-68.8	-64.8	-84.8	-58.8
+3	-103.8	-91.8	-55.8	-106.8	NM
+4	-98.8	-92.8	-96.8	NM	NM

IF = 1.9 GHz @ -10 dBm  
LO = 10.5 GHz @ 4 dBm

### MxN Spurious Outputs [1]

mIF	nLO				
	0	1	2	3	4
0	x	-55.68	-26.68	-52.68	-48.68
+1	-86.68	-46.68	0	-101.68	-77.68
+2	-60.68	-72.68	-68.68	-84.68	-61.68
+3	-113.68	-85.68	-67.68	NM	NM
+4	-99.68	-93.68	-111.68	NM	xx

IF = 1.9 GHz @ -10 dBm  
LO = 11 GHz @ 4 dBm

### MxN Spurious Outputs [2]

mIF	nLO				
	0	1	2	3	4
0	x	-55.69	-9.29	-38.69	-47.69
-1	-65.69	-95.69	0	-49.69	-57.69
-2	-51.69	-91.69	-58.69	-51.69	-49.69
-3	-97.69	-113.69	-64.69	-79.69	-98.69
-4	-92.69	NM	-110.69	-95.69	-97.69

IF = 2.9 GHz @ -10 dBm  
LO = 10.25 GHz @ 4 dBm

### MxN Spurious Outputs [2]

mIF	nLO				
	0	1	2	3	4
0	x	-55.59	-16.59	-47.59	-46.59
-1	-73.59	-96.59	0	-53.59	-66.59
-2	-52.59	-91.59	-69.59	-62.59	-51.59
-3	-106.59	-115.59	-65.59	-75.59	-99.59
-4	-95.59	-122.59	-109.59	-96.59	-94.59

IF = 2.9 GHz @ -10 dBm  
LO = 10.75 GHz @ 4 dBm

[1] All values in dBc below RF power level (2LO + IF) USB

[2] All values in dBc below RF power level (2LO + IF) LSB



## GaAs MMIC SUB-HARMONIC UPCONVERTER, 17.7 - 23.6 GHz

### MxN Spurious Outputs [2]

mIF	nLO				
	0	1	2	3	4
0	x	-53.63	-22.63	-50.63	-47.63
-1	-84.63	-101.63	0	-63.63	-73.63
-2	-58.63	-90.63	-65.63	-86.63	-57.63
-3	-110.63	-120.63	-62.63	-73.63	-102.63
-4	-100.63	NM	NM	-91.63	NM

IF = 2.9 GHz @ -10 dBm  
LO = 11.25 GHz @ 4 dBm

### MxN Spurious Outputs [2]

mIF	nLO				
	0	1	2	3	4
0	x	-47.72	-10.22	-52.72	-49.72
-1	-73.72	-97.72	0	-68.72	-70.72
-2	-62.72	-87.72	-57.72	-94.72	-55.72
-3	-112.72	NM	-63.72	-91.72	-109.72
-4	-109.72	NM	-117.72	-94.72	-110.72

IF = 2.9 GHz @ -10 dBm  
LO = 11.75 GHz @ 4 dBm

### MxN Spurious Outputs [2]

mIF	nLO				
	0	1	2	3	4
0	x	-40.7	-4.6	-3.44	-64.9
-1	-68.9	-89.9	0	-72.9	-59.9
-2	-67.9	-85.9	-63.9	NM	-63.9
-3	NM	NM	-66.9	NM	NM
-4	NM	NM	NM	NM	NM

IF = 2.9 GHz @ -10 dBm  
LO = 12.25 GHz @ 4 dBm

### MxN Spurious Outputs [2]

mIF	nLO				
	0	1	2	3	4
0	x	-37.7	-1.8	-64.2	xx
-1	-68.2	-85.2	0	-76.2	-67.2
-2	-71.2	-86.2	-57.2	NM	-66.2
-3	NM	NM	-68.2	NM	NM
-4	NM	NM	NM	NM	NM

IF = 2.9 GHz @ -10 dBm  
LO = 12.75 GHz @ 4 dBm

### MxN Spurious Outputs [2]

mIF	nLO				
	0	1	2	3	4
0	x	-40.8	-3	-65.1	xx
-1	-79.1	-84.1	0	NM	xx
-2	-80.1	-91.1	-85.1	NM	-62.1
-3	NM	NM	-71.1	NM	NM
-4	NM	NM	NM	NM	NM

IF = 2.9 GHz @ -10 dBm  
LO = 13.25 GHz @ 4 dBm

[1] All values in dBc below RF power level (2LO + IF) USB

[2] All values in dBc below RF power level (2LO + IF) LSB



## GaAs MMIC SUB-HARMONIC UPCONVERTER, 17.7 - 23.6 GHz

### Absolute Maximum Ratings

Drain Bias Voltage (Vdd1, 2, 3)	5.5V
Gate Bias Voltage (Vgg)	-2.0V
IF Input Power	+17 dBm
LO Drive	+10 dBm
Channel Temperature	175 °C
Continuous Pdiss (T=85°C) (derate 19.7 mW/°C above 85°C)	1.78 W
Thermal Resistance (R <sub>TH</sub> ) (channel to package bottom)	50.7 °C/W
Storage Temperature	-65 to +150 °C
Operating Temperature	-40 to +85 °C



ELECTROSTATIC SENSITIVE DEVICE  
OBSERVE HANDLING PRECAUTIONS

### Outline Drawing

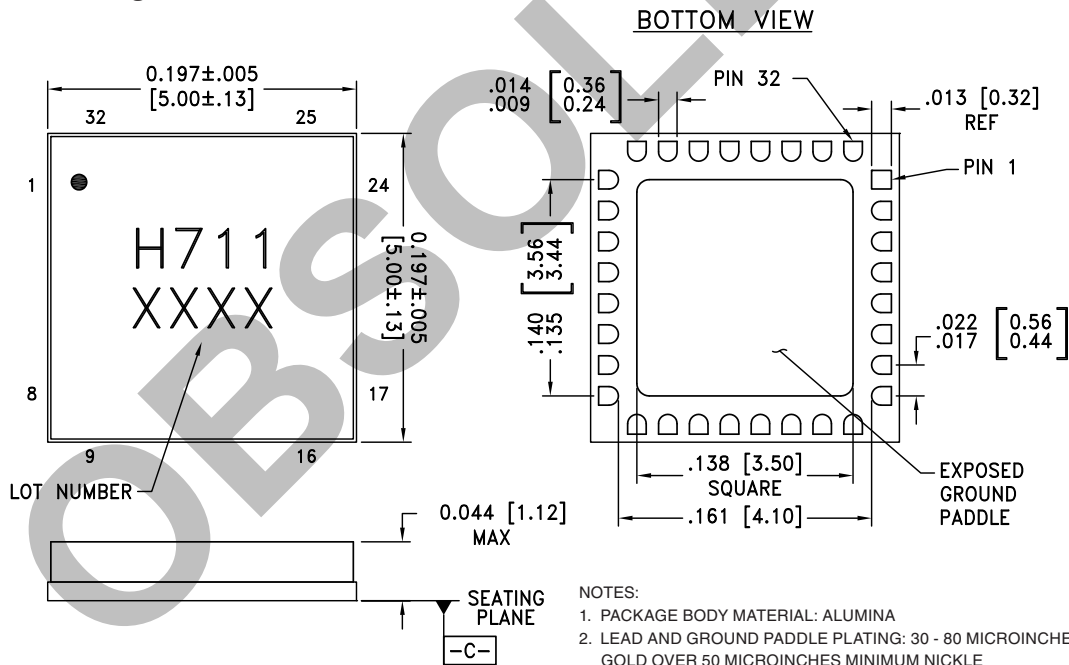

NOTES:

1. PACKAGE BODY MATERIAL: ALUMINA
2. LEAD AND GROUND PADDLE PLATING: 30 - 80 MICROINCHES GOLD OVER 50 MICROINCHES MINIMUM NICKLE
3. DIMENSIONS ARE IN INCHES [MILLIMETERS]
4. LEAD SPACING TOLERANCE IS NON-CUMULATIVE
5. PACKAGE WARP SHALL NOT EXCEED 0.05mm DATUM
6. ALL GROUND LEADS AND GROUND PADDLE MUST BE SOLDERED TO PCB RF GROUND

### Package Information

Part Number	Package Body Material	Lead Finish	MSL Rating	Package Marking <sup>[2]</sup>
HMC711LC5	Alumina, White	Gold over Nickel	MSL3 <sup>[1]</sup>	H711 XXXX

[1] Max peak reflow temperature of 260 °C

[2] 4-Digit lot number XXXX

## GaAs MMIC SUB-HARMONIC UPCONVERTER, 17.7 - 23.6 GHz

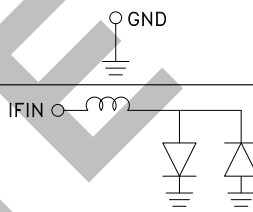
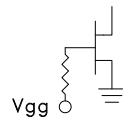
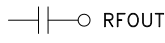
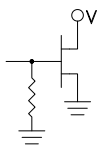
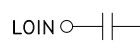
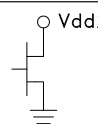

### Pin Descriptions

Pin Number	Function	Description	Interface Schematic
1 - 3, 7 - 12, 14 - 17, 23 - 26, 28, 31, 32	N/C	The pins are not connected internally; however, all data shown herein was measured with these pins connected to RF/DC ground externally.	
4, 6, 18, 20, 30	GND	These pins and the package bottom must be connected to RF/DC ground.	
5	IFIN	This pin is DC coupled. For applications not requiring operation to DC, this port should be DC blocked externally using a series capacitor whose value has been chosen to pass the necessary IF frequency range. For operation to DC, this pin must not source or sink more than 2 mA of current or part non-function and possible part failure will result.	
13	Vgg	Gate control for RF amplifier, please follow "MMIC Amplifier Biasing Procedure" application note. See application circuit for required external components	
19	RFOUT	This pin is AC coupled and matched to 50 Ohms.	
27	Vdd1	Power supply voltage for x2 multiplier. See application circuit for required external components.	
29	LOIN	This pin is AC coupled and matched to 50 Ohms.	
22, 21	Vdd2, Vdd3	Power supply voltage for RF amplifier. See application circuit for required external components.	

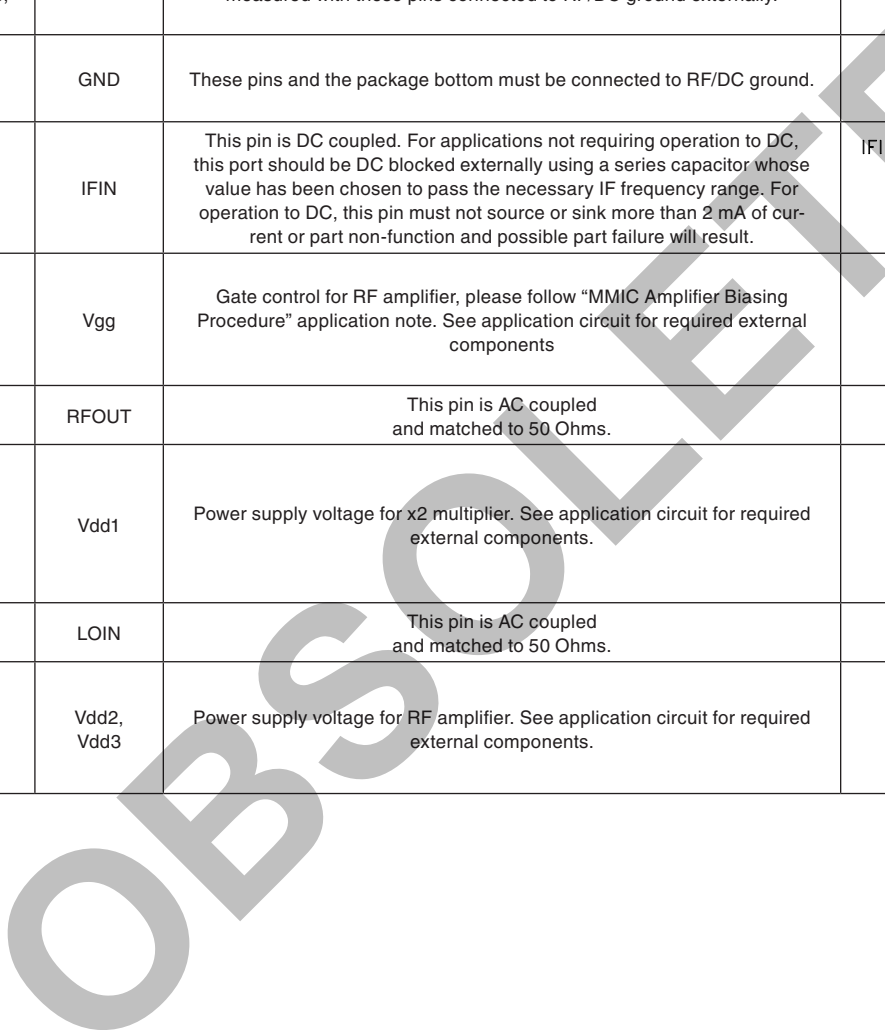



**GaAs MMIC SUB-HARMONIC  
UPCONVERTER, 17.7 - 23.6 GHz**

**Application Circuit**

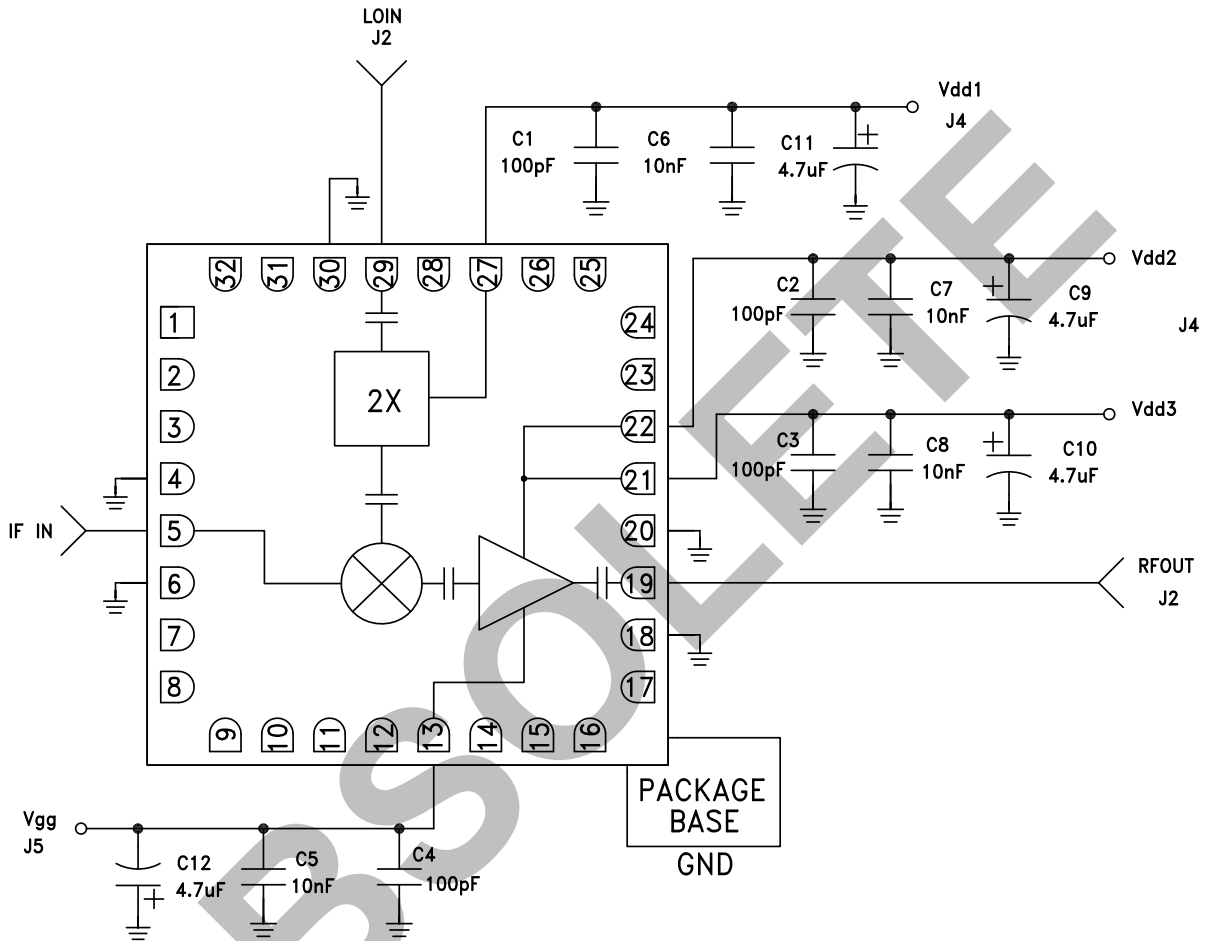



**GaAs MMIC SUB-HARMONIC UPCONVERTER, 17.7 - 23.6 GHz**

**Evaluation PCB**

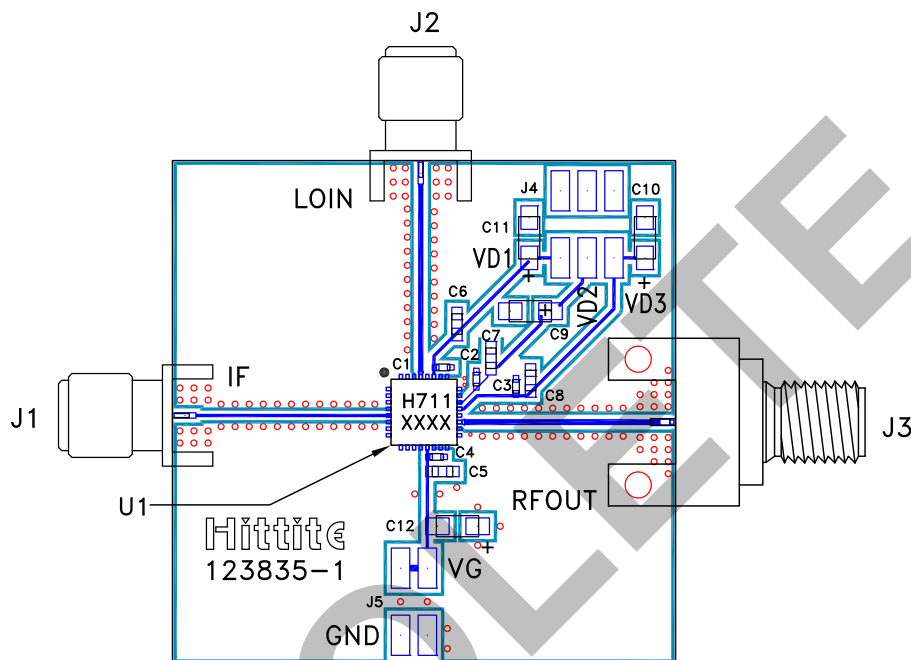

**List of Materials for Evaluation PCB 127912 [1]**

Item	Description
J1, J2	PCB Mount SMA Connector
J3	PCB Mount K Connector
J4, J5	2mm Molex DC Connector
C1 - C4	100 pF Capacitor, 0402 Pkg.
C5 - C8	10 nF Capacitor, 0603 Pkg.
C9 - C12	4.7 $\mu$ F Tantalum Capacitor Case A
U1	HMC711LC5 Upconverter
PCB [2]	123835 Evaluation Board

[1] Reference this number when ordering complete evaluation PCB

[2] Circuit Board Material: Rogers 4350 or Arlon 25FR

The circuit board used in the final application should use RF circuit design techniques. Signal lines should have 50 Ohm impedance while the package ground leads and exposed paddle should be connected directly to the ground plane similar to that shown. A sufficient number of via holes should be used to connect the top and bottom ground planes. The evaluation circuit board shown is available from Hittite upon request.