

GaAs MMIC 6-BIT DIGITAL PHASE SHIFTER, 2.9 - 3.9 GHz



Typical Applications

The HMC648LP6(E) is ideal for:

- EW Receivers
- Weather & Military Radar
- Satellite Communications
- Beamforming Modules
- Phase Cancellation

Features

- Low RMS Phase Error: 1.2°
- Low Insertion Loss: 5 dB
- High Linearity: +45 dBm
- Positive Control Logic
- 360° Coverage, LSB = 5.625°
- 28 Lead 6x6mm SMT Package: 36mm²

Functional Diagram

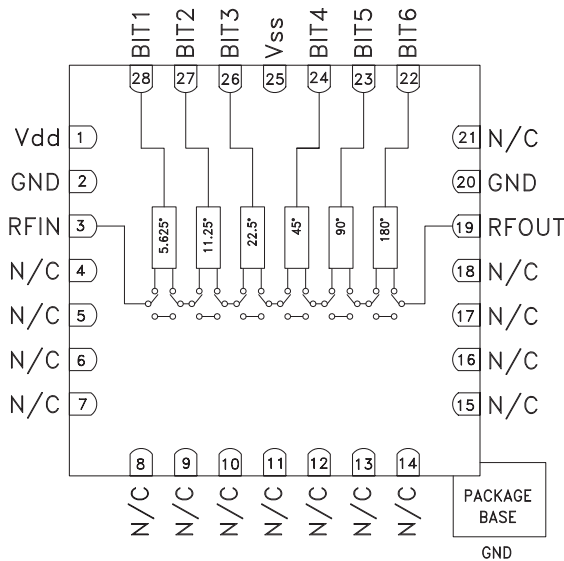

General Description

The HMC648LP6(E) is a 6-bit digital phase shifter which is rated from 2.9 - 3.9 GHz, providing 360 degrees of phase coverage, with a LSB of 5.625 degrees. The HMC648LP6(E) features very low RMS phase error of 1.2 degrees and extremely low insertion loss variation of ±0.5 dB across all phase states. This high accuracy phase shifter is controlled with positive control logic of 0/+5V. The HMC648LP6(E) is housed in a compact 6x6 mm plastic leadless SMT package and is internally matched to 50 Ohms with no external components.

Electrical Specifications

$T_A = +25^\circ\text{C}$, $V_{SS} = -5\text{V}$, $V_{DD} = +5\text{V}$, Control Voltage = 0/ +5V, 50 Ohm System

| Parameter | Min. | Typ. | Max. | Units |
|----------------------------------|------|------|-----------|-------|
| Frequency Range | 2.9 | | 3.9 | GHz |
| Insertion Loss* | | 5 | 8 | dB |
| Input Return Loss* | | 16 | | dB |
| Output Return Loss* | | 17 | | dB |
| Phase Error* | | ±5 | +10 / -15 | deg |
| RMS Phase Error | | 1.2 | | deg |
| Insertion Loss Variation* | | ±0.5 | | dB |
| Input Power for 1 dB Compression | | 31 | | dBm |
| Input Third Order Intercept | | 45 | | dBm |
| Control Voltage Current | | 35 | 250 | µA |
| Bias Control Current | | 5 | 15 | mA |

*Note: Major States Shown

Information furnished by Analog Devices is believed to be accurate and reliable. However, no responsibility is assumed by Analog Devices for its use, nor for any infringements of patents or other rights of third parties that may result from its use. Specifications subject to change without notice. No license is granted by implication or otherwise under any patent or patent rights of Analog Devices. Trademarks and registered trademarks are the property of their respective owners.

For price, delivery, and to place orders: Analog Devices, Inc., One Technology Way, P.O. Box 9106, Norwood, MA 02062-9106 Phone: 781-329-4700 • Order online at www.analog.com Application Support: Phone: 1-800-ANALOG-D



**GaAs MMIC 6-BIT DIGITAL
PHASE SHIFTER, 2.9 - 3.9 GHz**

Insertion Loss, Major States Only

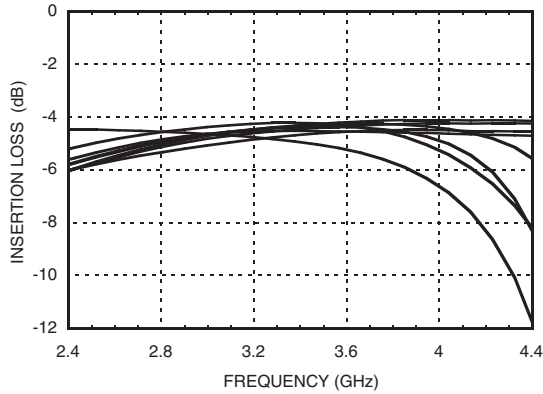

Normalized Loss, Major States Only

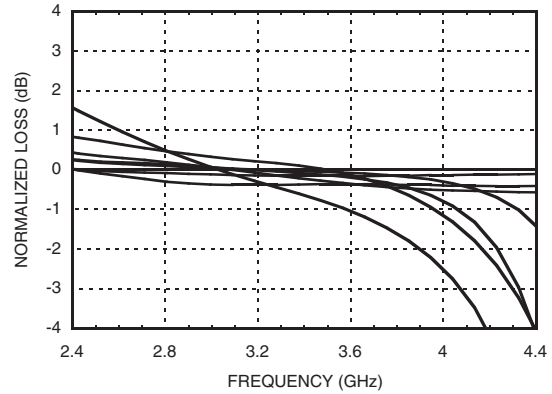

Input Return Loss, Major States Only

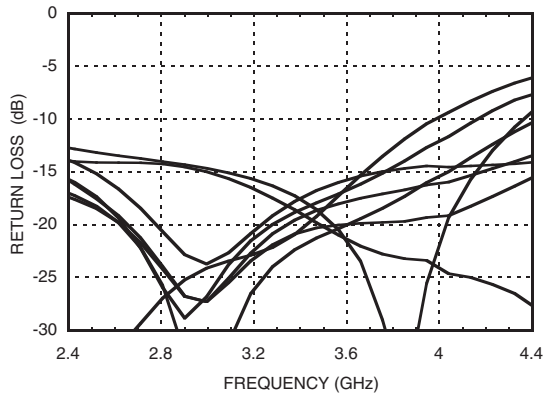

Phase Error, Major States Only

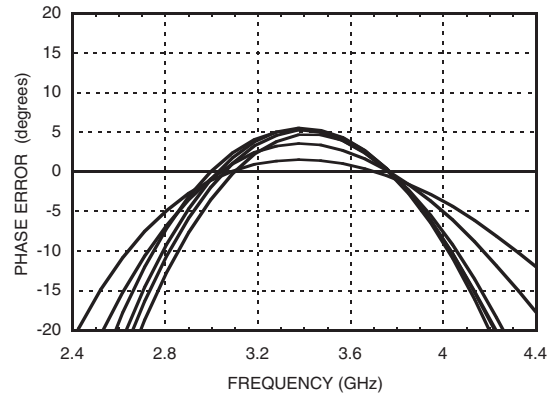

Output Return Loss, Major States Only

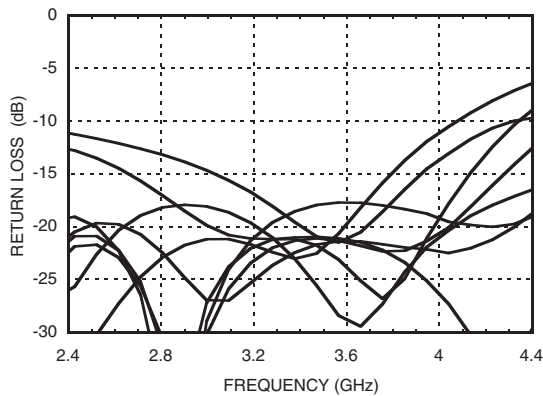

**Relative Phase Shift
Major States Including All Bits**

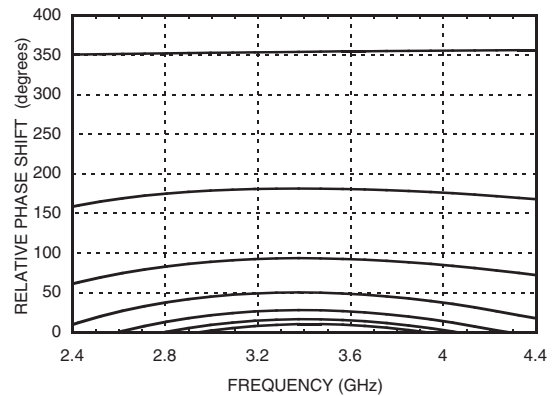

Information furnished by Analog Devices is believed to be accurate and reliable. However, no responsibility is assumed by Analog Devices for its use, nor for any infringements of patents or other rights of third parties that may result from its use. Specifications subject to change without notice. No license is granted by implication or otherwise under any patent or patent rights of Analog Devices. Trademarks and registered trademarks are the property of their respective owners.

For price, delivery, and to place orders: Analog Devices, Inc., One Technology Way, P.O. Box 9106, Norwood, MA 02062-9106 Phone: 781-329-4700 • Order online at www.analog.com Application Support: Phone: 1-800-ANALOG-D



**GaAs MMIC 6-BIT DIGITAL
PHASE SHIFTER, 2.9 - 3.9 GHz**

**Relative Phase Shift,
RMS, Average, Max, All States**

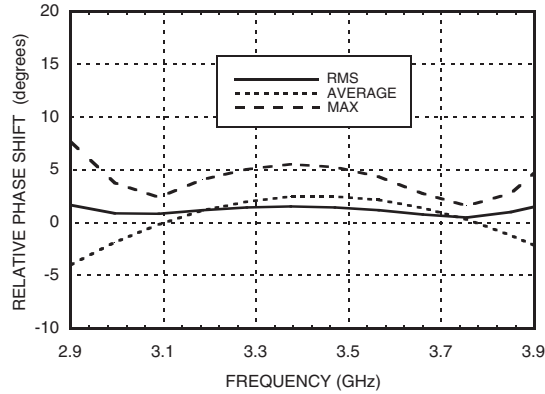

Input IP3, Major States Only

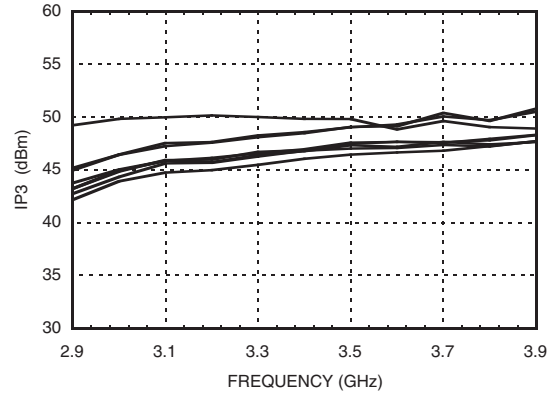

Input IP2, Major States Only

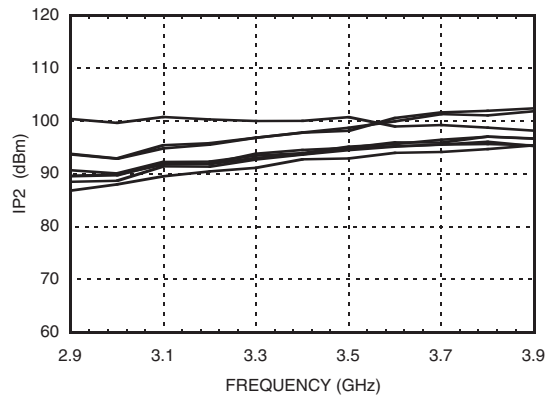

Input P1dB, Major States Only

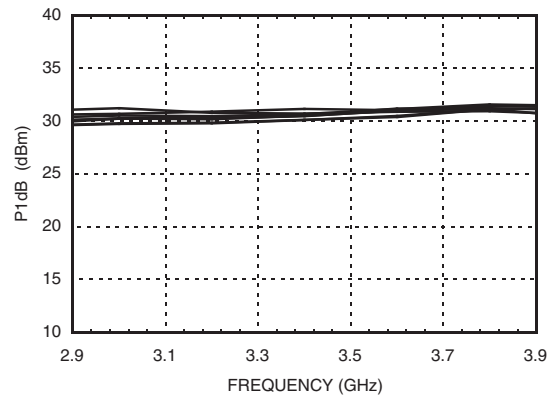

RMS Phase Error vs. Temperature

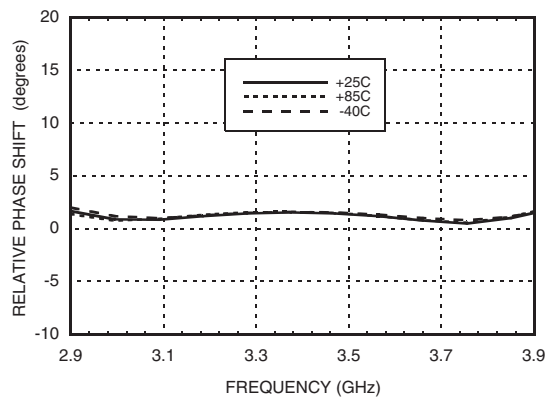

**Insertion Loss vs. Temperature,
Major States Only**

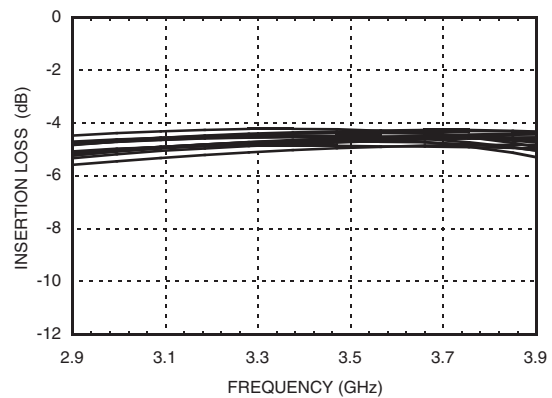

Information furnished by Analog Devices is believed to be accurate and reliable. However, no responsibility is assumed by Analog Devices for its use, nor for any infringements of patents or other rights of third parties that may result from its use. Specifications subject to change without notice. No license is granted by implication or otherwise under any patent or patent rights of Analog Devices. Trademarks and registered trademarks are the property of their respective owners.

For price, delivery, and to place orders: Analog Devices, Inc., One Technology Way, P.O. Box 9106, Norwood, MA 02062-9106 Phone: 781-329-4700 • Order online at www.analog.com Application Support: Phone: 1-800-ANALOG-D

10

PHASE SHIFTERS - DIGITAL - SMT



GaAs MMIC 6-BIT DIGITAL PHASE SHIFTER, 2.9 - 3.9 GHz

Phase Error vs. State

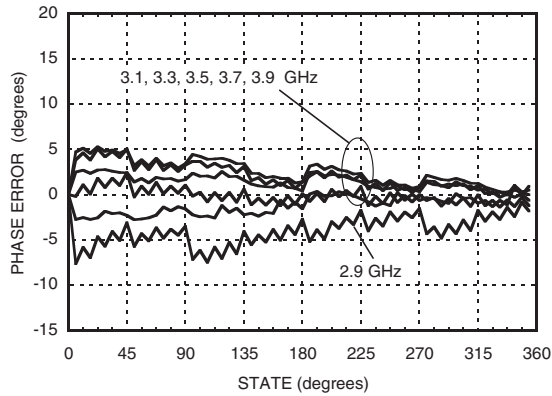

Absolute Maximum Ratings

| | |
|---|--------------------|
| Input Power (RFIN) | 33 dBm (T= +85 °C) |
| Bias Voltage Range (Vdd) | -0.2 to +12V |
| Bias Voltage Range (Vss) | +0.2 to -12V |
| Channel Temperature (Tc) | 150 °C |
| Thermal Resistance (channel to ground paddle) | 120 °C/W |
| Storage Temperature | -65 to +150 °C |
| Operating Temperature | -40 to +85 °C |

Bias Voltage & Current

| | |
|------|-------|
| Vdd | Idd |
| 5.0 | 5.2mA |
| Vss | Iss |
| -5.0 | 5.2mA |

Control Voltage

| State | Bias Condition |
|----------|---------------------------|
| Low (0) | 0 to 0.2 Vdc |
| High (1) | Vdd ±0.2 Vdc @ 35 µA Typ. |



**ELECTROSTATIC SENSITIVE DEVICE
OBSERVE HANDLING PRECAUTIONS**

Truth Table

| Control Voltage Input | | | | | | Phase Shift (Degrees) RFIN - RFOUT |
|-----------------------|-------|-------|-------|-------|-------|---------------------------------------|
| Bit 1 | Bit 2 | Bit 3 | Bit 4 | Bit 5 | Bit 6 | |
| 0 | 0 | 0 | 0 | 0 | 0 | Reference* |
| 1 | 0 | 0 | 0 | 0 | 0 | 5.625 |
| 0 | 1 | 0 | 0 | 0 | 0 | 11.25 |
| 0 | 0 | 1 | 0 | 0 | 0 | 22.5 |
| 0 | 0 | 0 | 1 | 0 | 0 | 45.0 |
| 0 | 0 | 0 | 0 | 1 | 0 | 90.0 |
| 0 | 0 | 0 | 0 | 0 | 1 | 180.0 |
| 1 | 1 | 1 | 1 | 1 | 1 | 354.375 |

Any combination of the above states will provide a phase shift approximately equal to the sum of the bits selected.

*Reference corresponds to monotonic setting

Information furnished by Analog Devices is believed to be accurate and reliable. However, no responsibility is assumed by Analog Devices for its use, nor for any infringements of patents or other rights of third parties that may result from its use. Specifications subject to change without notice. No license is granted by implication or otherwise under any patent or patent rights of Analog Devices. Trademarks and registered trademarks are the property of their respective owners.

For price, delivery, and to place orders: Analog Devices, Inc., One Technology Way, P.O. Box 9106, Norwood, MA 02062-9106
Phone: 781-329-4700 • Order online at www.analog.com
Application Support: Phone: 1-800-ANALOG-D



GaAs MMIC 6-BIT DIGITAL PHASE SHIFTER, 2.9 - 3.9 GHz

Outline Drawing

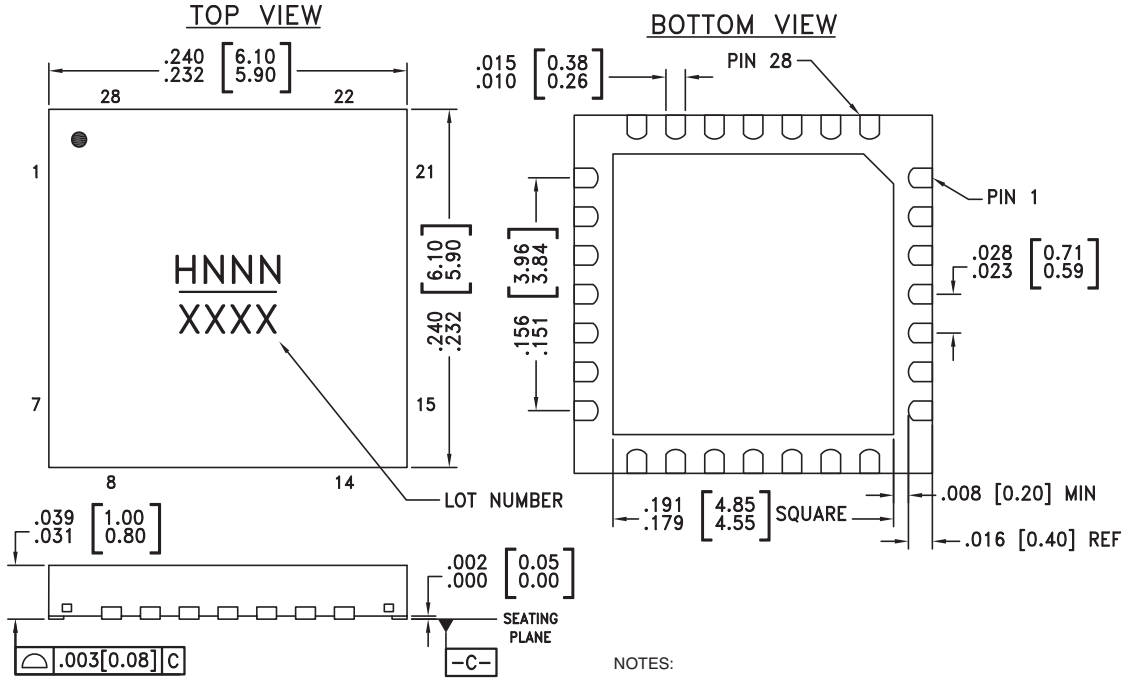



- NOTES:
1. LEADFRAME MATERIAL: COPPER ALLOY
 2. DIMENSIONS ARE IN INCHES [MILLIMETERS].
 3. DIMENSION DOES NOT INCLUDE MOLDFLASH OF 0.15mm PER SIDE.
 4. DIMENSION DOES NOT INCLUDE MOLDFLASH OF 0.25mm PER SIDE.
 5. ALL GROUND LEADS MUST BE SOLDERED TO PCB RF GROUND.
 6. CLASSIFIED AS MOISTURE SENSITIVITY LEVEL (MSL) 1.

Package Information

| Part Number | Package Body Material | Lead Finish | MSL Rating | Package Marking ^[3] |
|-------------|--|---------------|---------------------|--------------------------------|
| HMC648LP6 | Low Stress Injection Molded Plastic | Sn/Pb Solder | MSL1 ^[1] | H648 XXXX |
| HMC648LP6E | RoHS-compliant Low Stress Injection Molded Plastic | 100% matte Sn | MSL1 ^[2] | H648 XXXX |

[1] Max peak reflow temperature of 235 °C
 [2] Max peak reflow temperature of 260 °C
 [3] 4-Digit lot number XXXX

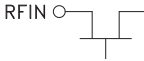
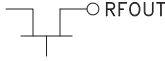
**GaAs MMIC 6-BIT DIGITAL
PHASE SHIFTER, 2.9 - 3.9 GHz**
Pin Descriptions

| Pin Number | Function | Description | Interface Schematic |
|---------------------|---------------------------------------|--|--|
| 1 | Vdd | Voltage supply. | |
| 2, 20 | GND | These pins and exposed ground paddle must be connected to RF/DC ground. |  |
| 3 | RFIN | This port is DC coupled and matched to 50 Ohms. |  |
| 4 - 18 | N/C | The pins are not connected internally; however, all data shown herein was measured with these pins connected to RF/DC ground externally. | |
| 19 | RFOUT | This port is DC coupled and matched to 50 Ohms. |  |
| 22 - 24, 26 - 28 | BIT6, BIT5, BIT4, BIT3, BIT2, BIT1 | Control Input. See truth table and control voltage tables. |  |
| 25 | Vss | Voltage supply. | |

10
PHASE SHIFTERS - DIGITAL - SMT

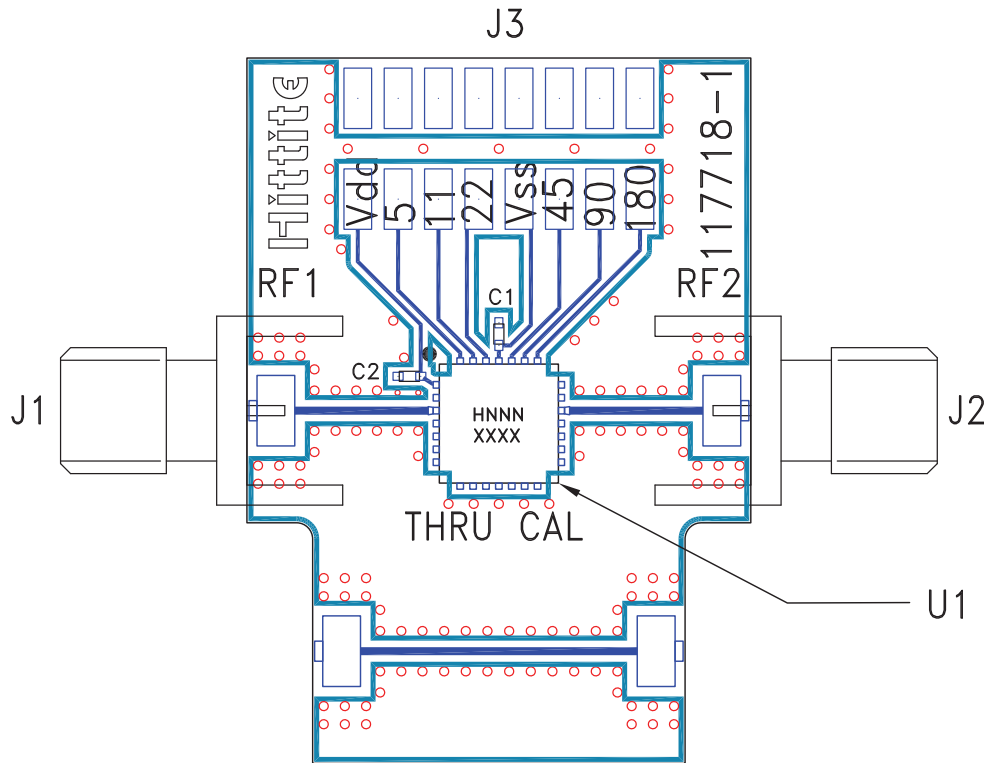
Evaluation PCB

List of Materials for Evaluation PCB 117720 [1][3]

| Item | Description |
|---------|--|
| J1 - J2 | PCB Mount SMA RF Connector |
| J3 | Header 2mm, 16 Pin |
| C1, C2 | 1000pF Capacitor, 0402 Pkg. |
| U1 | HMC648LP6(E) 6-Bit Digital Phase Shifter |
| PCB [2] | 117718 Evaluation PCB |

[1] Reference this number when ordering complete evaluation PCB

[2] Circuit Board Material: Rogers 4350

[3] Please refer to part's pin description and functional diagram for pin out assignments on evaluation board.

The circuit board used in the final application should use RF circuit design techniques. Signal lines should have 50 ohm impedance while the package ground leads and exposed paddle should be connected directly to the ground plane similar to that shown. A sufficient number of via holes should be used to connect the top and bottom ground planes. The evaluation board should be mounted to an appropriate heat sink. The evaluation circuit board shown is available from Hittite upon request.

**GaAs MMIC 6-BIT DIGITAL
PHASE SHIFTER, 2.9 - 3.9 GHz****Notes:**