

For NEW designs consider these replacement products:

• LUXEON HL1Z

LUXEON CSP HL1

High current density Chip Scale Package (CSP) LED

LUXEON CSP HL1 LEDs offer high flux density performance in a compact footprint, enabling elegant and superior luminaire designs. A wide range of CCTs in 80 and 90CRI options make them ideal for high performance indoor lighting applications, designed into tunable and white color mixing solutions. Best-in-class Color over Angle, and top emission only light output, provides designers with leading Quality of Light performance for dramatic lighting designs and small fixtures. The compact package size and high punch allows design flexibility, beam steering, and white tuning versus traditional LED light sources.



FEATURES AND BENEFITS

- Small package size (1.4 x 1.4 x 0.3mm) allows closely packed arrays for narrow beam spots
- Enables color mixing in CCT tunable applications
- High current densities for high lumen output and lm/\$ at high lm/W
- CSP 1mm² with 2 pads for direct attach enables ease of assembly
- Surface emission only for directional lighting without side light leakage
- High package densities

PRIMARY APPLICATIONS

- Panel / Soft Lights
- Wall Grazer
- Track Lights
- Linear
- Wall Wash
- Downlights

Table of Contents

General Product Information	2
Product Test Conditions	2
Part Number Nomenclature	2
Lumen Maintenance	2
Environmental Compliance	2
Performance Characteristics	3
Product Selection Guide	3
Optical Characteristics	3
Electrical and Thermal Characteristics	3
Absolute Maximum Ratings	4
Characteristic Curves	4
Spectral Power Distribution Characteristics	4
Light Output Characteristics	5
Forward Current Characteristics	6
Radiation Pattern Characteristics	7
Product Bin and Labeling Definitions	8
Decoding Product Bin Labeling	8
Luminous Flux Bins	8
Color Bin Definitions	9
Forward Voltage Bins	10
Mechanical Dimensions	10
Reflow Soldering Guidelines	11
JEDEC Moisture Sensitivity	11
Solder Pad Design	12
Packaging Information	13
Pocket Tape Dimensions	13
Reel Dimensions	14

General Product Information

Product Test Conditions

LUXEON CSP HL1 LEDs are tested and binned with a DC drive current of 350mA at a junction temperature, T_j , of 85°C.

Part Number Nomenclature

Part numbers for LUXEON CSP HL1 follow the convention below:

L **A** H L – **B B C C D D** 0 0 0 0 0 0 0

Where:

- A** – designates packaging option (0=bin sheet, 1=tape and reel)
- B B** – designates nominal ANSI CCT (27=2700K, 30=3000K, 35=3500K, 40=4000K, 50=5000K, 65=6500K)
- C C** – designates CRI (80=80CRI, 90=90CRI)
- D D** – designates die size of CSP (10=1mm²)

Therefore, the following part number is used for a LUXEON CSP HL1, 3000K 90CRI LED:

L **1** H L – **3 0 9 0 1 0** 0 0 0 0 0 0 0

Lumen Maintenance

Please contact your local Sales Representative or Lumileds Technical Solutions Manager for more information about the long-term performance of this product.

Environmental Compliance

Lumileds LLC is committed to providing environmentally friendly products to the solid-state lighting market. LUXEON CSP HL1 is compliant to the European Union directives on the restriction of hazardous substances in electronic equipment, namely the RoHS Directive 2011/65/EU and REACH Regulation (EC) 1907/2006. Lumileds LLC will not intentionally add the following restricted materials to its products: lead, mercury, cadmium, hexavalent chromium, polybrominated biphenyls (PBB) or polybrominated diphenyl ethers (PBDE).

Performance Characteristics

Product Selection Guide

Table 1. Product performance of LUXEON CSP HL1 at 350mA, $T_j=85^\circ\text{C}$.

NOMINAL CCT	CRI ^(1, 2)	LUMINOUS FLUX ⁽¹⁾ (lm)		PART NUMBER
		MINIMUM	TYPICAL	
2700	80	90	99	L1HL-2780100000000
3000	80	90	104	L1HL-3080100000000
3500	80	100	109	L1HL-3580100000000
4000	80	100	113	L1HL-4080100000000
5000	80	100	116	L1HL-5080100000000
6500	80	110	119	L1HL-6580100000000
2700	90	70	86	L1HL-2790100000000
3000	90	80	93	L1HL-3090100000000
3500	90	80	96	L1HL-3590100000000
4000	90	90	104	L1HL-4090100000000
5000	90	90	104	L1HL-5090100000000
6500	90	90	107	L1HL-6590100000000

Notes for Table 1:

- Lumileds maintains a tolerance of ± 2 on CRI and $\pm 6.5\%$ on luminous flux measurements.
- Typical CRI is approximately 2 points higher for those parts with minimum 70CRI specified, but this is not guaranteed. Minimum CRI is 68.5 for parts with 70CRI typical.

Optical Characteristics

Table 2. Optical characteristics for LUXEON CSP HL1 at 350mA, $T_j=85^\circ\text{C}$.

PART NUMBER	TYPICAL TOTAL INCLUDED ANGLE ⁽¹⁾	TYPICAL VIEWING ANGLE ⁽²⁾
L1HL-xxxx100000000	140°	120°

Notes for Table 2:

- Total angle at which 90% of total luminous flux is captured.
- Viewing angle is the off axis angle from the LED centerline where the luminous intensity is $\frac{1}{2}$ of the peak value.

Electrical and Thermal Characteristics

Table 3. Electrical and thermal characteristics for LUXEON CSP HL1 at 350mA, $T_j=85^\circ\text{C}$.

PART NUMBER	FORWARD VOLTAGE ⁽¹⁾ (V_f)			TYPICAL TEMPERATURE COEFFICIENT OF FORWARD VOLTAGE ⁽²⁾ (mV/°C)	TYPICAL THERMAL RESISTANCE—JUNCTION TO SOLDER PAD (°C/W)
	MINIMUM	TYPICAL	MAXIMUM		
L1HL-xxxx100000000	2.65	2.80	3.00	-2	4

Notes for Table 3:

- Lumileds maintains a tolerance of $\pm 0.06\text{V}$ on forward voltage measurements.
- Measured between 25°C and 85°C.

Absolute Maximum Ratings

Table 4. Absolute maximum ratings for LUXEON CSP HL1.

PARAMETER	MAXIMUM PERFORMANCE
DC Forward Current ^[1,2]	700mA
Peak Pulsed Forward Current ^[1,3]	850mA
LED Junction Temperature ^[1] (DC & Pulse)	135°C
ESD Sensitivity (ANSI/ESDA/JEDEC JS-001-2012)	250V
Operating Case Temperature ^[1]	-40°C to 135°C
LED Storage Temperature	-40°C to 125°C
Soldering Temperature	JEDEC 020D.1 260°C
Allowable Reflow Cycles	3
Autoclave Conditions	NA
Reverse Voltage ^[4] ($V_{reverse}$)	LUXEON LEDs are not designed to be driven in reverse bias

Notes for Table 4:

- Proper current derating must be observed to maintain the junction temperature below the maximum allowable junction temperature.
- Residual periodic variations due to power conversion from alternating current (AC) to direct current (DC), also called "ripple," with frequencies $\geq 100\text{Hz}$ and amplitude $\leq 850\text{mA}$ are acceptable, assuming the average current throughout each cycle does not exceed the maximum allowable DC forward current at the corresponding maximum junction temperature.
- Pulsed operation with a peak drive current equal to the stated peak pulsed forward current is acceptable if the pulse on-time is $\leq 5\text{ms}$ per cycle and the duty cycle is $\leq 50\%$.
- Transient reverse voltages and surge currents due to electrical switching or supply interruptions are acceptable if these events do not last for more than 10ms, the amplitude of the reverse voltage does not exceed 5V and the reverse current is less than 220uA.

Characteristic Curves

Spectral Power Distribution Characteristics

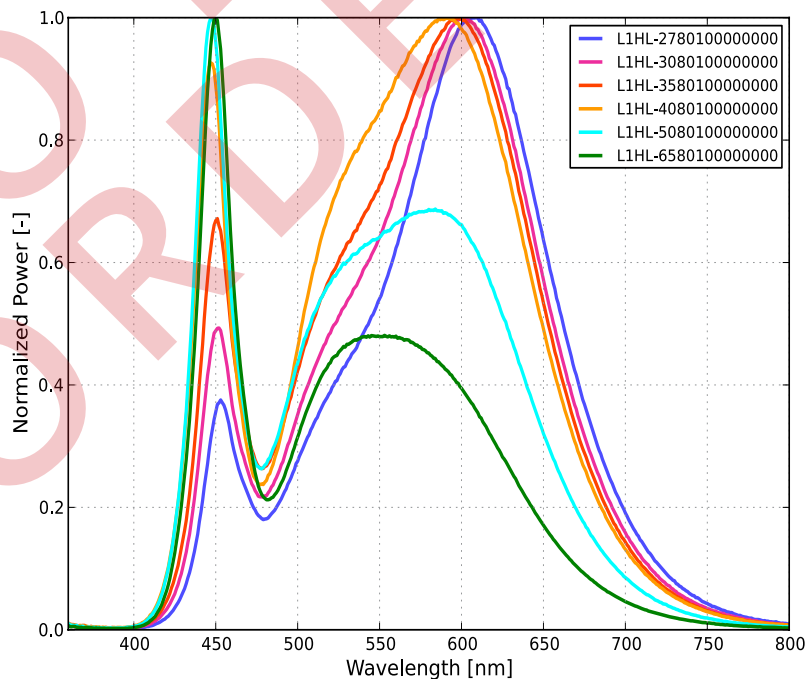

Figure 1. Typical normalized power vs. wavelength for L1HL-xx8010000000 at 350mA, $T_j=85^\circ\text{C}$.

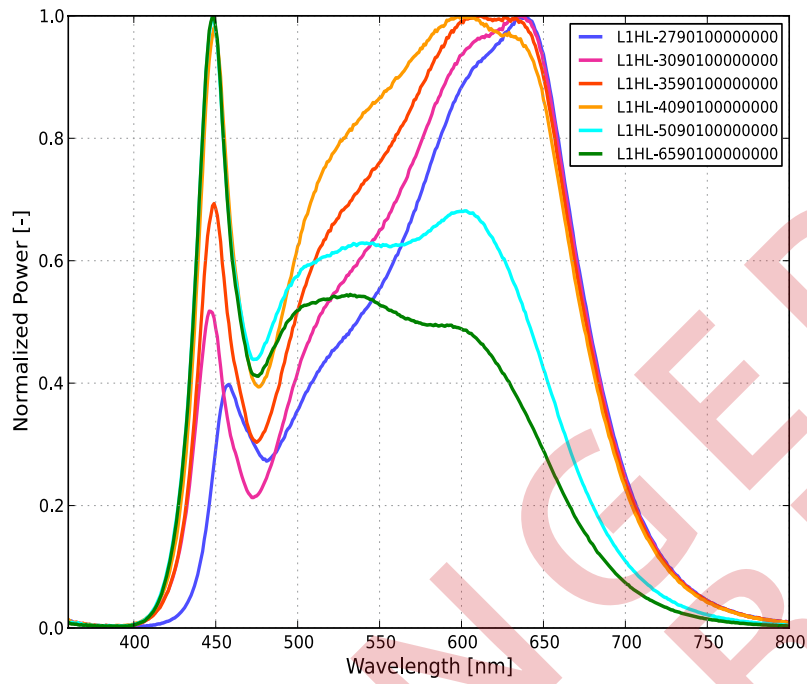

Figure 2. Typical normalized power vs. wavelength for L1HL-xx9010000000 at 350mA, $T_j=85^\circ\text{C}$.

Light Output Characteristics

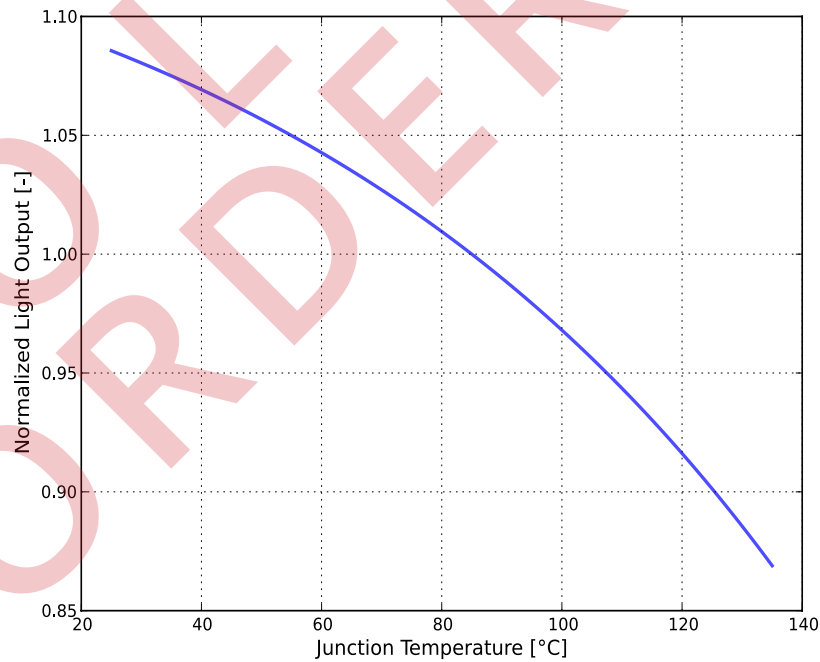

Figure 3. Typical normalized light output vs. junction temperature for LUXEON CSP HL1 at 350mA, $T_j=85^\circ\text{C}$.

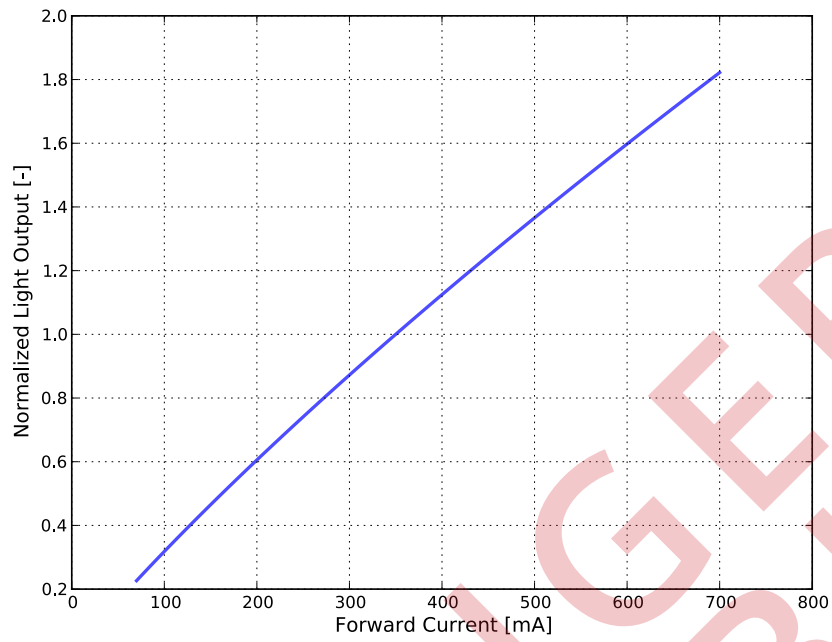

Figure 4. Typical normalized light output vs. forward current for LUXEON CSP HL1 at 350mA, $T_j=85^\circ\text{C}$.

Forward Current Characteristics

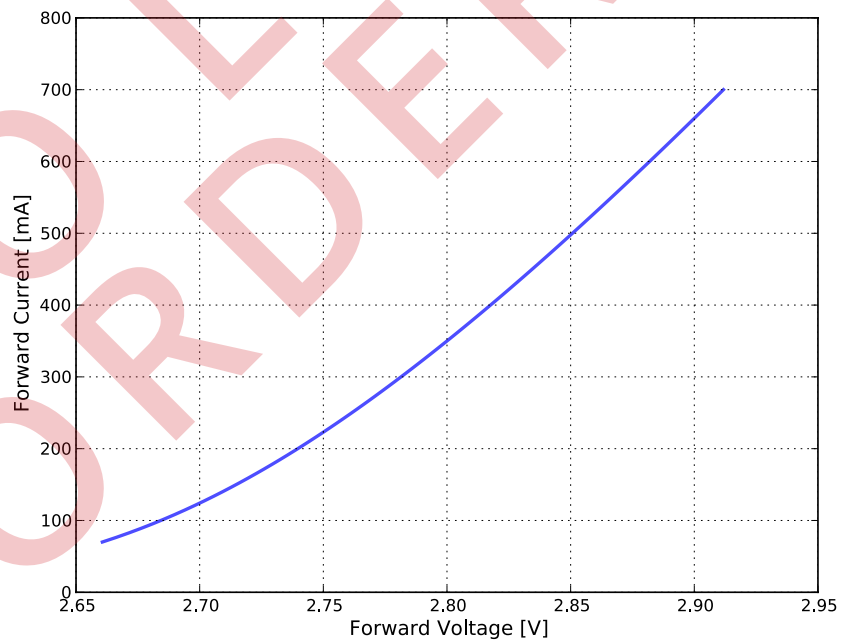

Figure 5. Typical forward current vs. forward voltage for LUXEON CSP HL1 at $T_j=85^\circ\text{C}$.

Radiation Pattern Characteristics

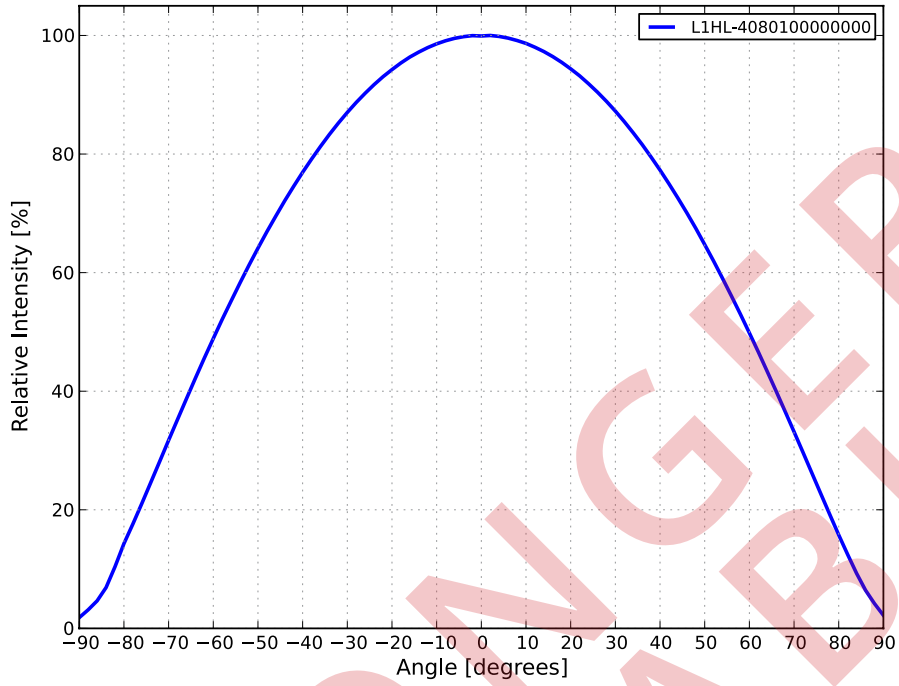

Figure 6. Typical radiation pattern for LUXEON CSP HL1 at 350mA, $T_j=85^{\circ}\text{C}$.

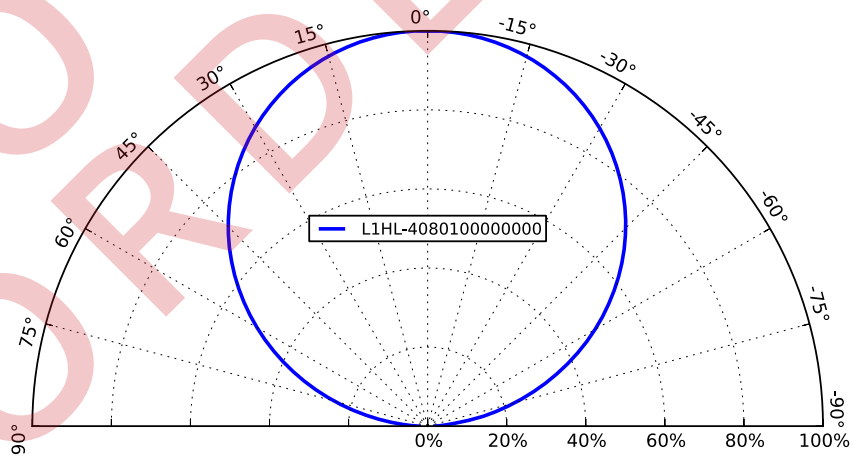

Figure 7. Typical polar radiation pattern for LUXEON CSP HL1 at 350mA, $T_j=85^{\circ}\text{C}$.

Product Bin and Labeling Definitions

Decoding Product Bin Labeling

In the manufacturing of semiconductor products, there are variations in performance around the average values given in the technical datasheet. For this reason, Lumileds bins LED components for luminous flux or radiometric power, color point, peak or dominant wavelength and forward voltage.

LUXEON CSP HL1 LEDs are labeled using a 4-digit alphanumeric CAT code following the format below:

A B C D

Where:

- A** – designates luminous flux bin (example: H=100 to 110 lm, K=120 to 130 lm)
- B** – designates color bin (example: 1=6500K, 3=5000K, 5=4000K, 6 = 3500K, 7=3000K, 8=2700K)
- C** – designates color space (example: 3, U, or L for 3-step MacAdam ellipse; A, B, C, or D for 5-step MacAdam ellipse)
- D** – designates forward voltage bin (example: X=2.65 to 2.80V, Y=2.80 to 3.00V)

Therefore, a LUXEON CSP HL1 with a lumen range of 100 to 110 lm, CCT of 5000K, 5-step MacAdam ellipse color bin C, and a forward voltage range of 2.80 to 3.00V has the following CAT code:

H 3 C Y

Luminous Flux Bins

Table 5 lists the standard luminous flux bins for LUXEON CSP HL1 emitters. Although several bins are outlined, product availability in a particular bin varies by production run and by product performance. Not all bins are available in all CCTs.

Table 5. Luminous flux bin definitions for LUXEON CSP HL1, T_j=85°C.

BIN	LUMINOUS FLUX ⁽¹⁾ (lm)	
	MINIMUM	MAXIMUM
A	30	40
B	40	50
C	50	60
D	60	70
E	70	80
F	80	90
G	90	100
H	100	110
J	110	120
K	120	130
L	130	140
M	140	150
N	150	160
P	160	170

Notes for Table 5:

1. Lumileds maintains a tolerance of ±6.5% on luminous flux measurements.

Color Bin Definitions

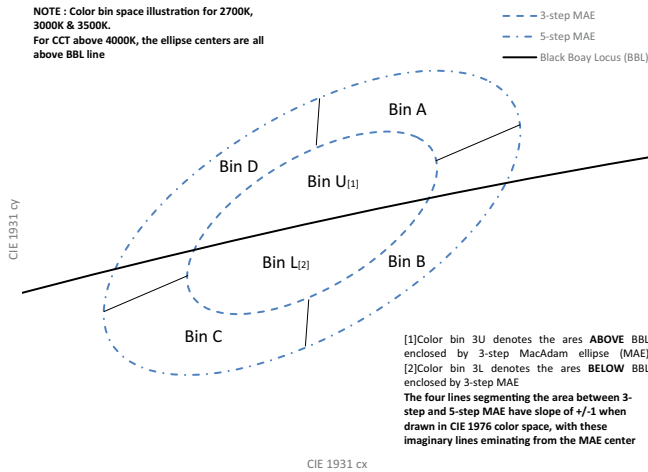

Figure 8. Color space definition for LUXEON CSP HL1.

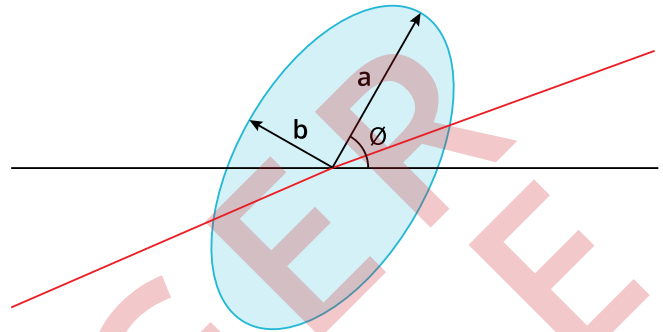

Figure 9. 3- and 5-step MacAdam ellipse illustration for Table 6.

Table 6. 3- and 5-step MacAdam ellipse color bin definitions for LUXEON CSP HL1.

NOMINAL CCT	COLOR SPACE	CENTER POINT ^[1] (cx, cy)	MAJOR AXIS, a	MINOR AXIS, b	ELLIPSE ROTATION ANGLE, θ
2700K	Single 3-step MacAdam ellipse	(0.4578, 0.4101)	0.008 100	0.004 200	53.70°
	Single 5-step MacAdam ellipse		0.013 500	0.007 000	
3000K	Single 3-step MacAdam ellipse	(0.4338, 0.4030)	0.008 340	0.004 080	53.22°
	Single 5-step MacAdam ellipse		0.013 900	0.006 800	
3500K	Single 3-step MacAdam ellipse	(0.4073, 0.3917)	0.009 270	0.004 140	54.00°
	Single 5-step MacAdam ellipse		0.015 450	0.006 900	
4000K	Single 3-step MacAdam ellipse	(0.3818, 0.3797)	0.009 390	0.004 020	53.72°
	Single 5-step MacAdam ellipse		0.015 650	0.006 700	
5000K	Single 3-step MacAdam ellipse	(0.3447, 0.3553)	0.008 220	0.003 540	59.62°
	Single 5-step MacAdam ellipse		0.013 700	0.005 900	
6500K	Single 3-step MacAdam ellipse	(0.3123, 0.3282)	0.006 690	0.002 850	58.57°
	Single 5-step MacAdam ellipse		0.011 150	0.004 750	

Notes for Table 6:

1. Lumileds maintains a tolerance of ±0.005 on x and y coordinates in the CIE 1931 color space.

Table 7. Correlated color temperature bin definitions for LUXEON CSP HL1.

BIN	CCT
1	6500K
3	5000K
5	4000K
6	3500K
7	3000K
8	2700K

Table 8. MacAdam ellipse color bin definitions for LUXEON CSP HL1.

BIN	SDCM
3	3-step MacAdam ellipse ($\geq 4000\text{K}$)
U	3-step MacAdam ellipse ($< 4000\text{K}$)
L	3-step MacAdam ellipse ($< 4000\text{K}$)
A	5-step MacAdam ellipse (all CCT-CRI)
B	5-step MacAdam ellipse (all CCT-CRI)
C	5-step MacAdam ellipse (all CCT-CRI)
D	5-step MacAdam ellipse (all CCT-CRI)

Forward Voltage Bins

Table 9. Forward voltage bin definitions for LUXEON CSP HL1.

BIN	FORWARD VOLTAGE ⁽¹⁾ (V _f)	
	MINIMUM	MAXIMUM
X	2.65	2.80
Y	2.80	3.00

Notes for Table 9:

1. Lumileds maintains a tolerance of $\pm 0.06\text{V}$ on forward voltage measurements.

Mechanical Dimensions

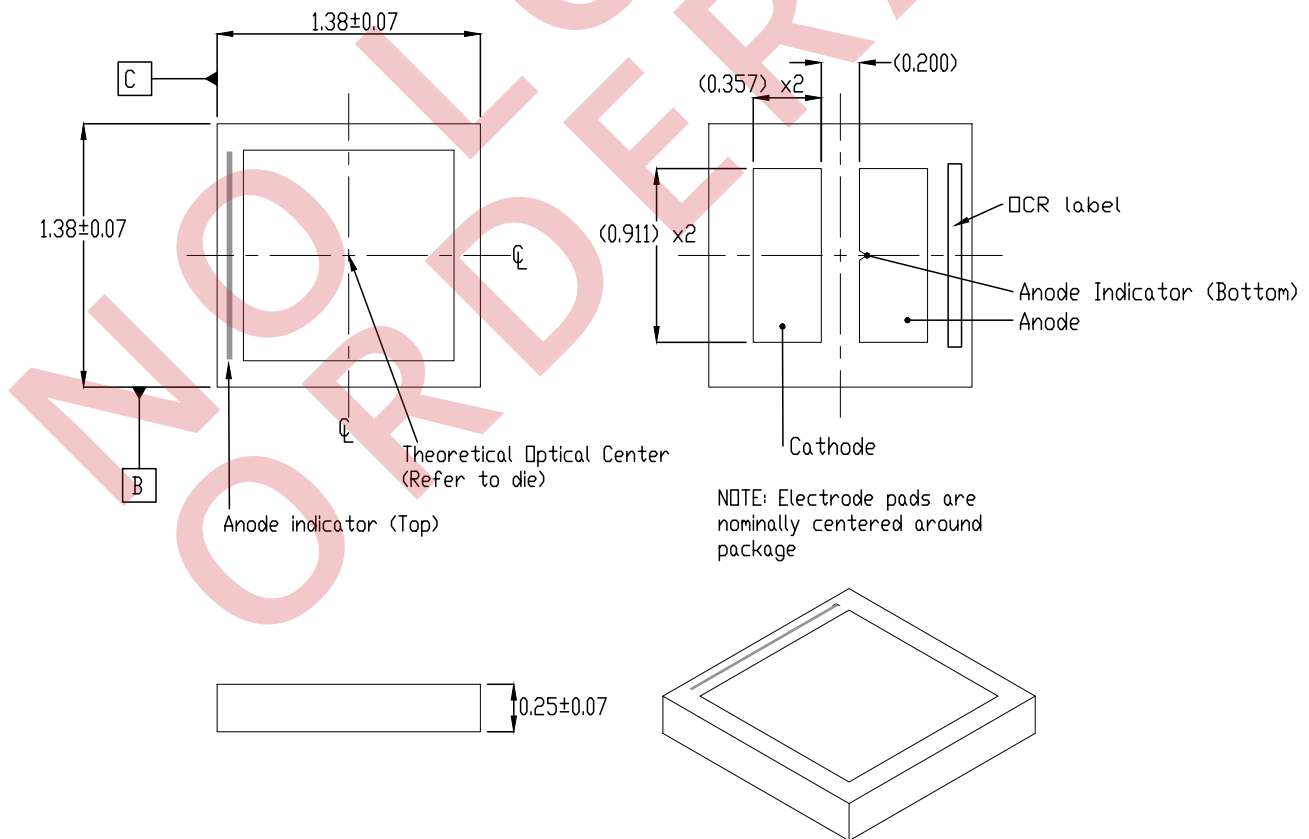

Figure 10. Mechanical dimensions for LUXEON CSP HL1.

Notes for Figure 10:

1. Drawings are not to scale.
2. All dimensions are in millimeters.

Reflow Soldering Guidelines

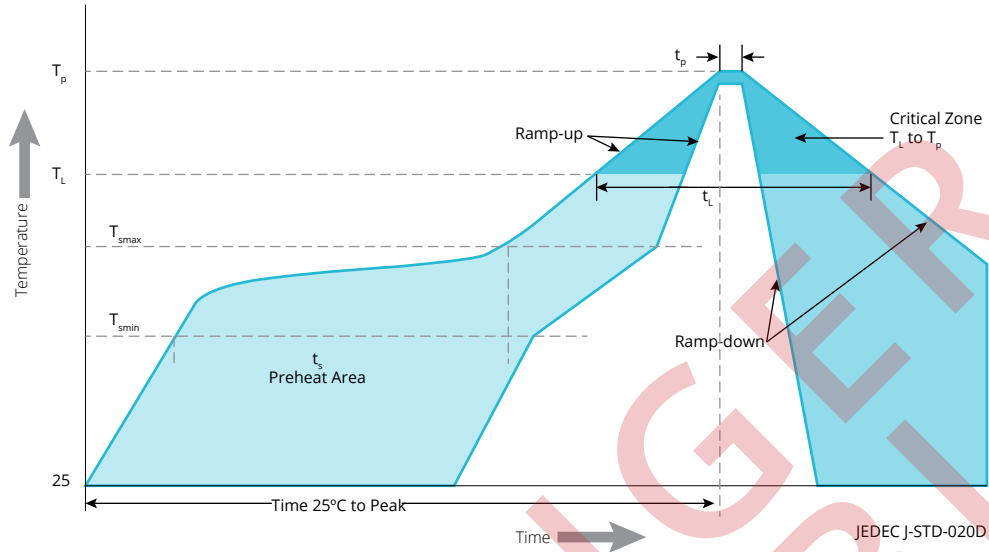

Figure 11. Visualization of the acceptable reflow temperature profile as specified in Table 10.

Table 10. Reflow profile characteristics for LUXEON CSP HL1.

PROFILE FEATURE	LEAD-FREE ASSEMBLY
Preheat Minimum Temperature (T_{smin})	150°C
Preheat Maximum Temperature (T_{smax})	200°C
Preheat Time (t_{smin} to t_{smax})	60 to 180 seconds
Ramp-Up Rate (T_L to T_p)	3°C / second maximum
Liquidous Temperature (T_L)	217°C
Time Maintained Above Temperature T_L (t_t)	60 to 150 seconds
Peak / Classification Temperature (T_p)	260°C
Time Within 5°C of Actual Peak Temperature (t_p)	20 to 40 seconds
Ramp-Down Rate (T_p to T_L)	6°C / second maximum
Time 25°C to Peak Temperature	8 minutes maximum

Notes for Table 10:

1. All temperatures refer to the application Printed Circuit Board (PCB), measured on the surface adjacent to the package body.

JEDEC Moisture Sensitivity

Table 11. Moisture sensitivity levels for LUXEON CSP HL1.

LEVEL	FLOOR LIFE		SOAK REQUIREMENTS STANDARD	
	TIME	CONDITIONS	TIME	CONDITIONS
1	Unlimited	≤30°C / 85% RH	168 Hours +5 / -0	85°C / 85% RH

Solder Pad Design

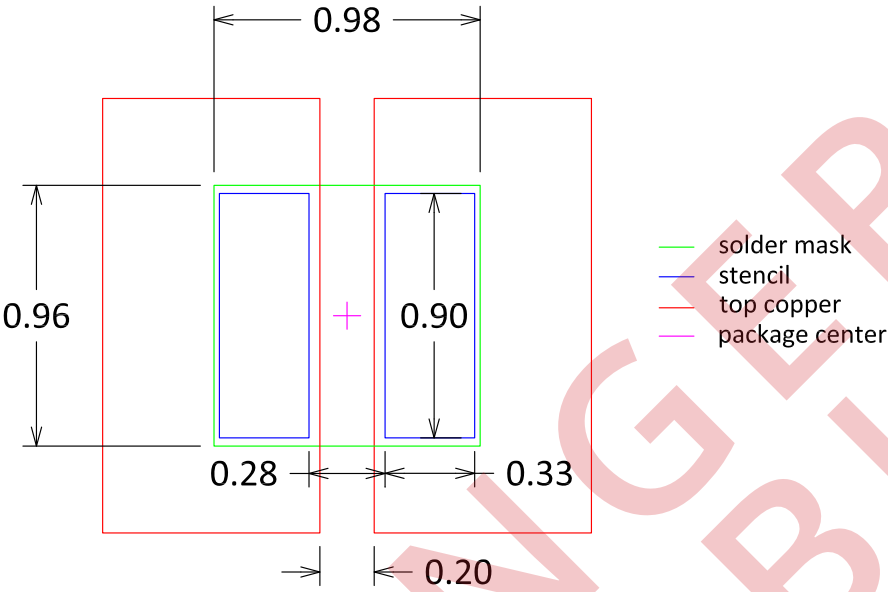

Figure 12. Recommended PCB solder pad layout for LUXEON CSP HL1.

- Notes for Figure 12:
- 1. Drawings are not to scale.
 - 2. All dimensions are in millimeters.

Packaging Information

Pocket Tape Dimensions

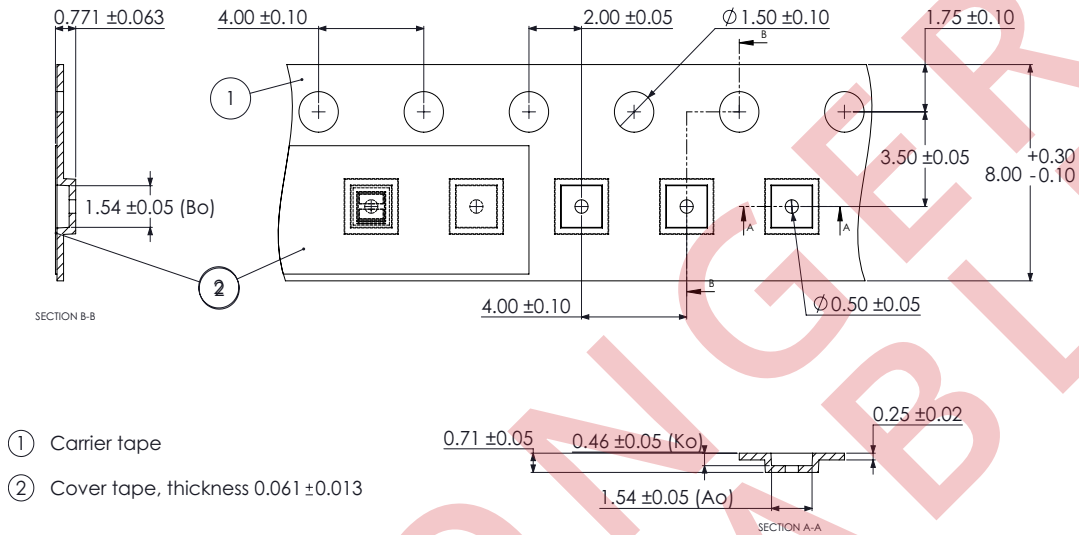

Figure 13. Pocket tape dimensions for LUXEON CSP HL1.

Notes for Figure 13:

1. Drawings are not to scale.
2. All dimensions are in millimeters.

Reel Dimensions

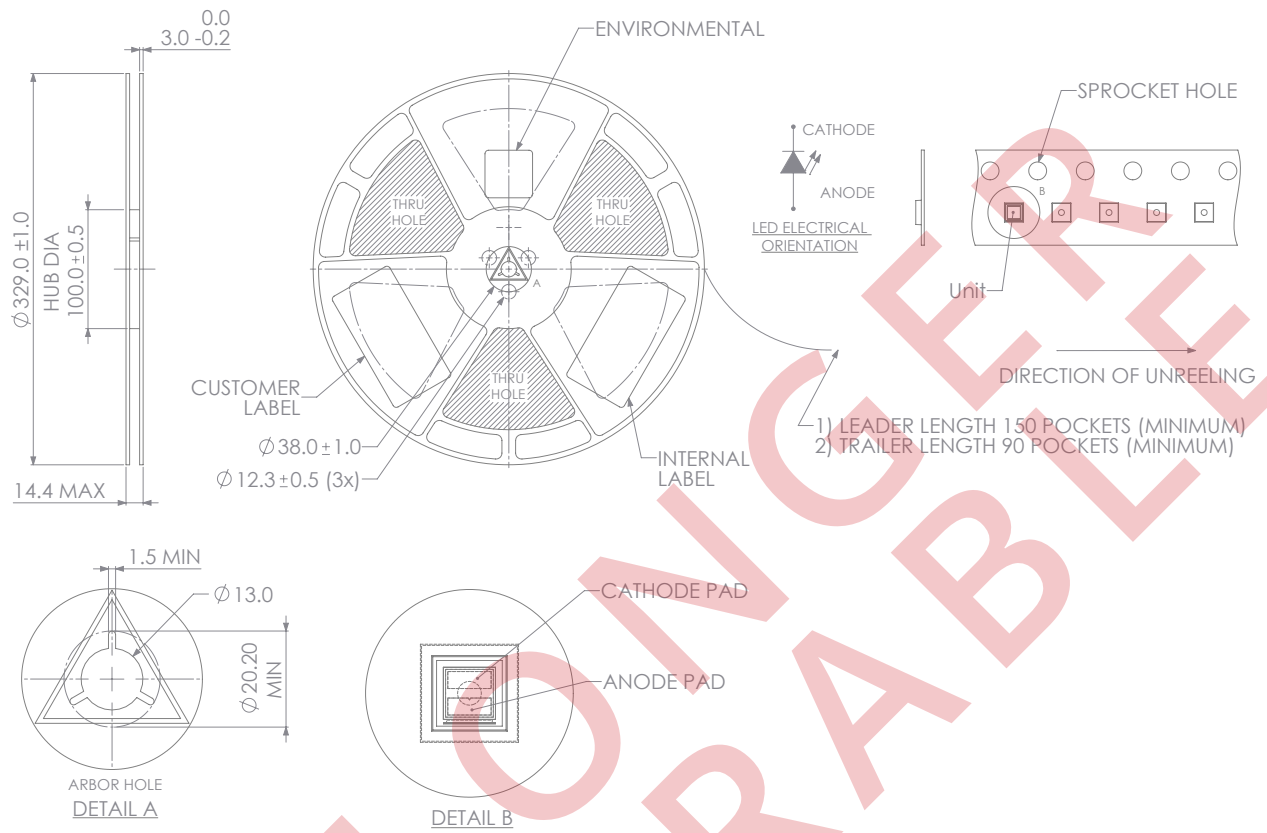

Figure 14. Reel dimensions for LUXEON CSP HL1.

Notes for Figure 14:

1. Drawings are not to scale.
2. All dimensions are in millimeters.

About Lumileds

Companies developing automotive, mobile, IoT and illumination lighting applications need a partner who can collaborate with them to push the boundaries of light. With over 100 years of inventions and industry firsts, Lumileds is a global lighting solutions company that helps customers around the world deliver differentiated solutions to gain and maintain a competitive edge. As the inventor of Xenon technology, a pioneer in halogen lighting and the leader in high performance LEDs, Lumileds builds innovation, quality and reliability into its technology, products and every customer engagement. Together with its customers, Lumileds is making the world better, safer, more beautiful—with light.

To learn more about our lighting solutions, visit lumileds.com.

NO LONGER AVAILABLE



©2022 Lumileds Holding B.V. All rights reserved. LUXEON is a registered trademark of the Lumileds Holding B.V. in the United States and other countries.

lumileds.com

Neither Lumileds Holding B.V. nor its affiliates shall be liable for any kind of loss of data or any other damages, direct, indirect or consequential, resulting from the use of the provided information and data. Although Lumileds Holding B.V. and/or its affiliates have attempted to provide the most accurate information and data, the materials and services information and data are provided "as is," and neither Lumileds Holding B.V. nor its affiliates warrants or guarantees the contents and correctness of the provided information and data. Lumileds Holding B.V. and its affiliates reserve the right to make changes without notice. You as user agree to this disclaimer and user agreement with the download or use of the provided materials, information and data. A listing of Lumileds product/patent coverage may be accessed at lumileds.com/patents.