

PIN Silicon Photodiode

OP913 Series



Features:

- TO-05 hermetically sealed package
- Linear response vs. irradiance
- Fast switching time
- Narrow receiving angle
- Enhanced temperature range



Description:

OP913SL and OP913WSL consist of a PIN silicon photodiode mounted in a two-leaded TO-05 hermetically sealed package.

OP913SL has a dome lens with an acceptance angle of 10° when measured from the optical axis to the half power point.

OP913WSL has a flat lens with an acceptance half angle of 30°. This large active area allows very low light level detection.

Please refer to Application Bulletins 208 and 210 for additional design information and reliability (degradation) data.

Applications:

- Non-contact reflective object sensor
- Assembly line automation
- Machine automation
- Machine safety
- End of travel sensor
- Door sensor

Ordering Information			
Part Number	Sensor	Viewing Angle	Lead Length
OP913SL	Photodiode	20°	0.50"
OP913WSL		80°	

OP913SL, OP913WSL

OP913SL, OP913WSL



Pin#	Sensor
1	Cathode
2	Anode

OP913WSL

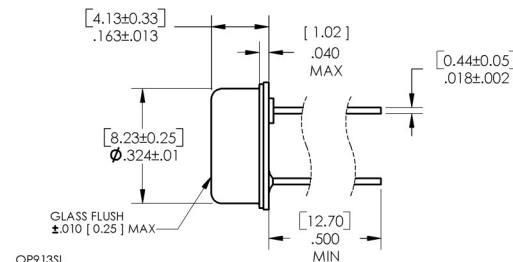

OP913SL

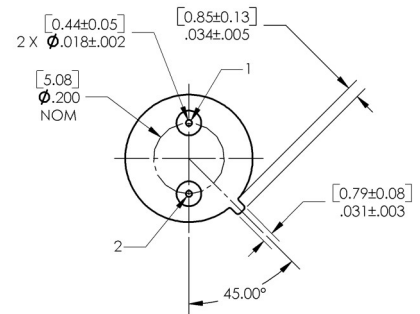
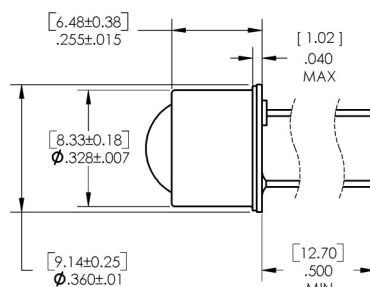

DIMENSIONS ARE IN: [MILLIMETERS] INCHES



RoHS

General Note

TT Electronics reserves the right to make changes in product specification without notice or liability. All information is subject to TT Electronics' own data and is considered accurate at time of going to print.

Electrical Specifications

Absolute Maximum Ratings ($T_A = 25^\circ\text{C}$ unless otherwise noted)	
Storage Temperature Range	-65° C to +150° C
Operating Temperature Range	-65° C to +125° C
Reverse Voltage	32 V
Lead Soldering Temperature [1/16 inch (1.6 mm) from the case for 5 seconds with soldering iron]	260° C ⁽¹⁾
Power Dissipation	150 mW ⁽²⁾

Electrical Characteristics ($T_A = 25^\circ\text{C}$ unless otherwise noted)						
SYMBOL	PARAMETER	MIN	TYP	MAX	UNITS	TEST CONDITIONS
I_L	Reverse Light Current: OP913SL OP913WSL	120 40	- -	- -	μA	$V_R = 5\text{ V}, E_E = 5\text{ mW/cm}^2$ ⁽³⁾⁽⁴⁾
I_D	Reverse Dark Current	-	-	25	nA	$V_R = 10\text{ V}, E_E = 0$ ⁽³⁾
V_{CC}	Open Circuit Voltage: OP913SL OP913WSL	- -	400 300	- -	mW	$E_E = 5\text{ mW/cm}^2$ ⁽⁴⁾
I_{SC}	Short Circuit Current: OP913SL OP913WSL	120 40	- -	- -	V	$E_E = 5\text{ mW/cm}^2$ ⁽⁴⁾
V_{BR}	Reverse Breakdown Voltage	32	-	-	V	$E_E = 100\ \mu\text{A}$
C_T	Total Capacitance	-	-	150	pF	$V_R = 0, E_E = 0, f = 1\text{ MHz}$
t_{ON}, t_{OFF}	Turn On / Turn Off Time	-	50	-	ns	$V_R = 10\text{ V}, R_L = 1\text{ k}\Omega$

Notes:

- (1) RMA flux is recommended. Duration can be extended to a maximum of 10 seconds when flow soldering.
- (2) Derate linearly 1.5 mW/° C above 25° C.
- (3) Junction temperature for all devices in this data sheet is maintained at 25° C.
- (4) Light source is an unfiltered tungsten bulb operating at $T_C = 2870\text{ K}$ or equivalent infrared source.
- (5) At any particular wavelength the flux responsivity, R_θ is related to quantum efficiency by: $R_\theta = \eta q (\lambda/1240)$, where ηq is the quantum efficiency in electrons per photon and λ is the wavelength in nanometers; thus at 900 nm, 0.60 A/W corresponds to a quantum efficiency of 83%.
- (6) NEP is the radiant flux at a specified wavelength, required for unity signal-to-noise ratio normalized for bandwidth. NEP calculation is made using responsivity at peak sensitivity wavelength, with spot noise measurement at 1000 Hz in a noise bandwidth of 6 Hz. $(\lambda, f, \Delta f) = (\lambda_p, 1000\text{ Hz}, 6\text{ Hz})$.

General Note

TT Electronics reserves the right to make changes in product specification without notice or liability. All information is subject to TT Electronics' own data and is considered accurate at time of going to print.

Performance

OP913SL, OP913WSL

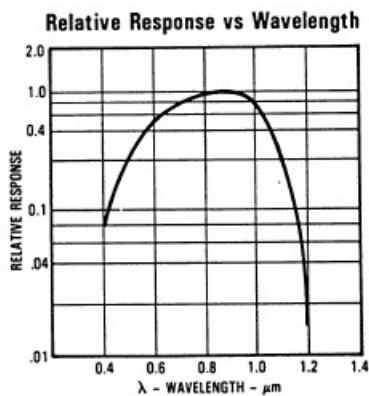
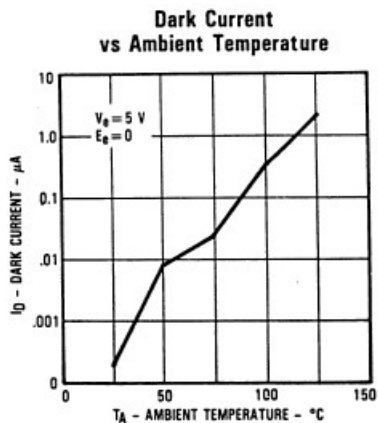
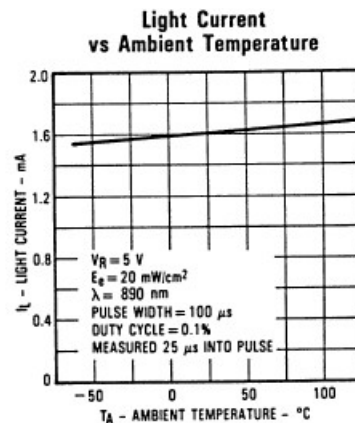
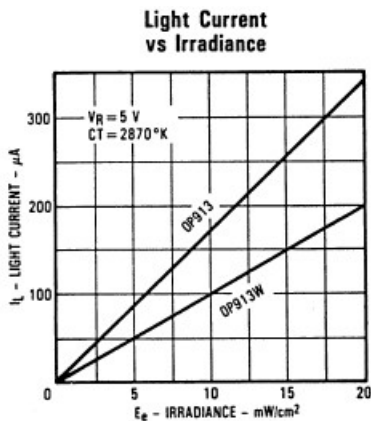
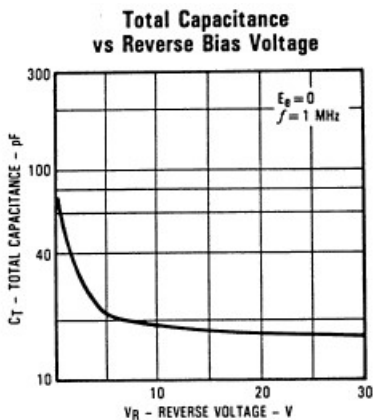

General Note

TT Electronics reserves the right to make changes in product specification without notice or liability. All information is subject to TT Electronics' own data and is considered accurate at time of going to print.