

DAKOTA MICRO

User Manual

AHD Wireless Waterproof Receiver and Transmitter Kits

Dakota Micro Part Numbers(s):

AHD Wireless Waterproof Receiver Kit – DM-HRX

AHD Wireless Waterproof Transmitter Kit – DM-HTX

AGCO Part Number(s):

AHD Wireless Waterproof Receiver Kit – AG-HRX

AHD Wireless Waterproof Transmitter Kit – AG-HTX

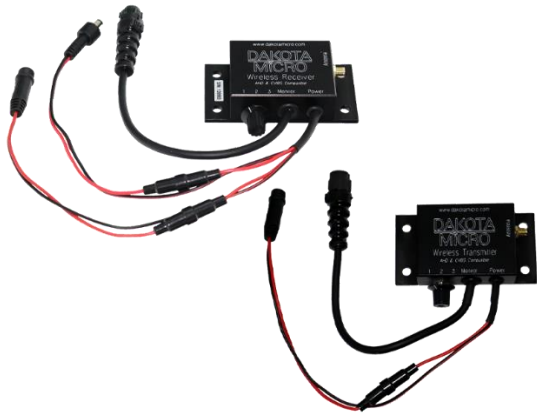

**SEE
WHAT
YOU'VE
BEEN
MISSING**

Table of Contents

I. <u>Before you Install</u>	3
II. <u>Available Kits</u>	3
III. <u>Included Wireless Components</u>	3
IV. <u>Standard Features</u>	4
V. <u>Parts of an AHD Wireless System</u>	4
VI. <u>External Antennas</u>	6
VII. <u>Installation</u>	7
A. <u>Installation Tips</u>	7
B. <u>Transmitter Installation</u>	7
C. <u>Receiver Installation</u>	7
VIII. <u>Emissions Notifications</u>	8
IX. <u>Specifications</u>	9
X. <u>Warnings</u>	9
XI. <u>Product Warranty/Repair Process</u>	11
XII. <u>Consumer Limited Warranty</u>	12
XIII. <u>Disclaimer</u>	12
XIV. <u>Contact Us</u>	12

*Always read the manual prior to operating this equipment. Also, please follow all safety signs and precautions.
See the Dakota Micro, Inc. website for installation training videos at www.dakotamicro.com*

THIS PAGE
INTENTIONALLY
LEFT BLANK

I. BEFORE YOU INSTALL

- Always read the manuals prior to operating this equipment, & please follow all safety signs and precautions. See DM website for installation training videos at www.dakotamicro.com.
- In order to better understand your new wireless equipment, we recommend that you power both your transmitter and receiver in an indoor, controlled location (i.e. from one side of a room to another) to better get acquainted with the equipment before installing it in its permanent location.

II. AVAILABLE KITS





PN: **DM-HXPAIR** Kit Includes PN's:
DM-HRX (AHD wireless waterproof receiver)
DM-HTX (AHD wireless waterproof transmitter)





NOTE: Each transmitter may only transmit signal from one camera, however you may receive that signal on multiple receivers.

III. INCLUDED WIRELESS COMPONENTS

PER PN: DM(AG)-HTX

PER PN: DM(AG)-HRX

Description	Picture
AHD Waterproof Transmitter Assembly (x HTX)	
12 Volt Power Adapter (DM-12V)	
12 Volt Hardwire Power Adapter (DM-HDWRE)	
3 AMP A/C Power Adapter Locking (DM-PA3)	
Wireless 3dBi Antenna (DM-RH3A)	

Description	Picture
AHD Waterproof Receiver Assembly (x HRX)	
12 Volt Power Adapter (DM-12V)	
12 Volt Hardwire Power Adapter (DM-HDWRE)	
3 AMP A/C Power Adapter Locking (DM-PA3)	
Wireless 3dBi Antenna (DM-RH3A)	

IV. STANDARD FEATURES

- Allows for easy wireless upgrade for your Dakota Micro camera system
- Your AgCam or EnduraCam monitor is conveniently powered by your receiver for mobile applications
- Wireless waterproof receiver supports up to three (3) wireless cameras/channels.
- Transmitters and Receivers are available for purchase individually
- Waterproof transmitters and receivers can be mounted outside in hot, cold, or wet conditions
- Transmits on powerful and reliable 2.4GHz bandwidth
- Optional antennas allow you to view cameras up to 1 mile away (with line of sight)
- Channel selection switch on receiver allows for easy access to multiple cameras.
- Capable of transmitting and receiving both AHD and CVBS (Analog) video signals

V. PARTS OF AN AHD WIRELESS SYSTEM

Waterproof Transmitter (PN: DM(AG)-HTX)

1. Power Input (DC Power IN 3000mA) to power the Transmitter
2. Power out to camera. Video signal in from camera.
3. AV channel select (3 channels)– rotate dial to select channel, set transmitter and receiver to same channel.
4. Antenna Input (Reverse SMA)

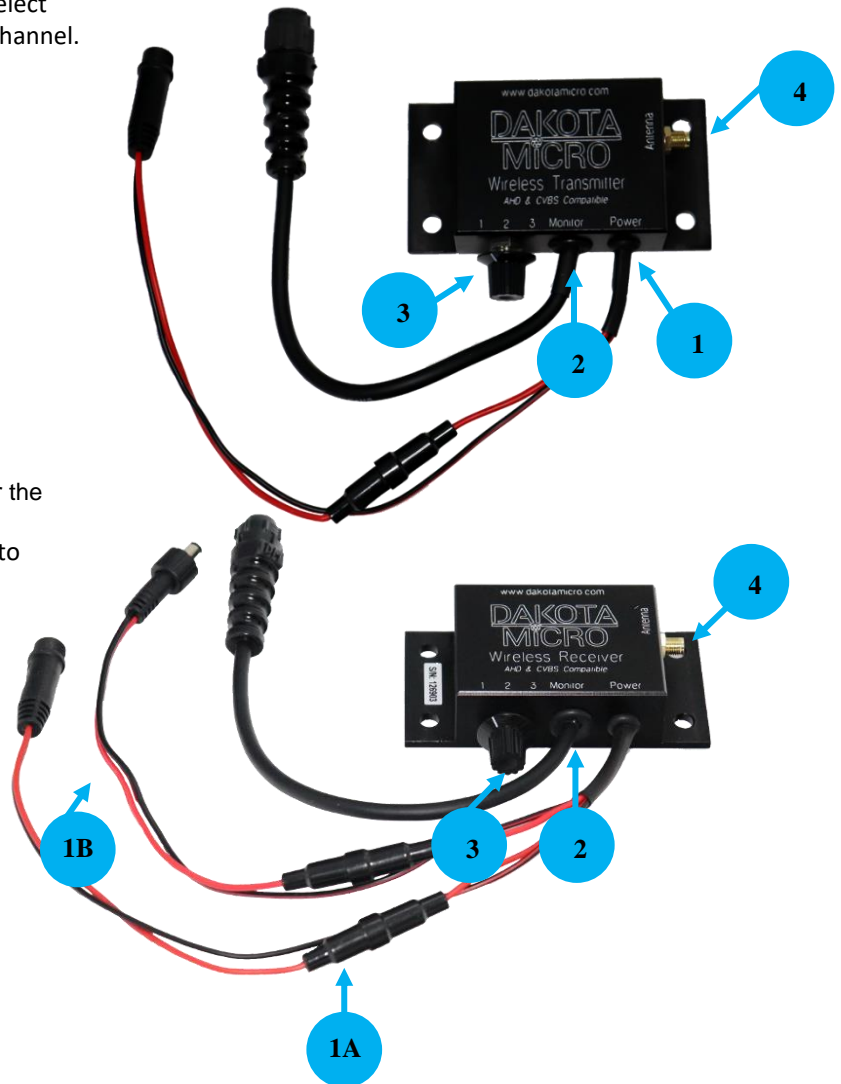

Waterproof Receiver (PN: DM(AG)-HRX)

1. A. Power Input (DC Power IN 3000mA) to power the Receiver
B. Power Output (DC Power OUTPUT 3000mA) to power the Monitor (optional)
2. Video signal out to monitor.
3. AV Channel Select (3 channels)– Rotate dial to select channel, set transmitter and receiver to same channel
4. Antenna Input (Reverse SMA)

VI. EXTERNAL ANTENNAS

Included Accessory – Wireless 3dBi Antenna (included accessory) *Maximum Distance - 2,000' (feet)*

BENEFITS

- Small
- No extra cost

TIPS

- Short transmitter and receiver distance
- No add-on extension cable



Available Accessory - Magnet Mount Mobile 5dBi Antenna w/ 6' cable (PN: DMAC-MA5) *Maximum Distance 2,600' (feet)*

BENEFITS

- Magnet Mount is great for mobile applications
- Low Cost

TIPS

- Extra metal plate needed for plastic cabs
- No add-on extension cable

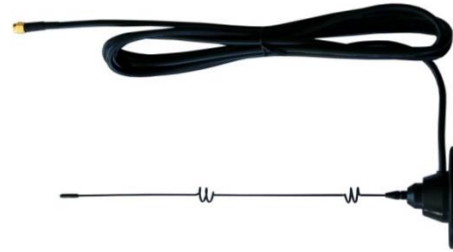

Available Accessory – Permanent Mount Mobile 7dBi Antenna w/ 6' cable (PN: DMAC-MA7-PM) *Maximum Distance 2,600' (feet)*

BENEFITS

- Permanent Mount
- Low Cost

TIPS

- No metal plate needed for plastic cabs
- No add-on extension cable



Available Accessory - 8dBi Omni-Directional Antenna w/ 20' cable (PN: DMAC-WA8) *Maximum Distance 1 mile*

BENEFITS

- Sturdy construction
- Additional extension cables available

TIPS

- Omni-directional signal operates like a “fan” so that the signal will not be received/transmitted directly below or above



Available Accessory - 8dBi Directional Antenna w/ 20' cable (PN: DMAC-WA8P) *Maximum Distance 1 mile*

BENEFITS

- Full transmission aimed in one direction
- Can be mounted on side of buildings

TIPS

- Transmits and/or receives in one direction only



Antenna Notes: Line of sight is important with this wireless equipment. Use of wireless equipment in enclosed spaces drastically reduces signal strength. For best results, it is recommended to mount an antenna on the exterior of the structure. Dakota Micro does not support or recommend the use of third-party antennas. It is recommended to use antennas of the same strength on both the transmitter and receiver.

THIS PAGE
INTENTIONALLY
LEFT BLANK

VII. INSTALLATION

A. Installation Tips

- Always test equipment before installing, to ensure proper signal strength and picture quality
- Line of sight means there are no obstructions such as buildings and tree belts. The fewer obstructions, the less interference to cause picture quality issues.
- There are several environmental conditions that may affect the range and quality of transmission. These may include electrical lines, Wi-Fi, wireless device signals like handheld radios, government agencies and radio stations. Therefore, Dakota Micro cannot guarantee any specific ranges.
- You may use AgCam® cables to mount camera up to 120 feet from transmitter.

B. Transmitter Installation

When being used with an AgCam® or EnduraCam®:

- 1) Attach supplied 3dBi antenna (1) or optional larger accessory antenna (details on page 5 of manual).
- 2) Connect the provided A/C power adaptor into the transmitter (2), then plug into outlet to power.
- 3) Plug the AgCam® or EnduraCam® camera directly into the wireless camera input (3).
- 4) Extension cables may be used to locate the camera away from the transmitter for up to 120 feet.

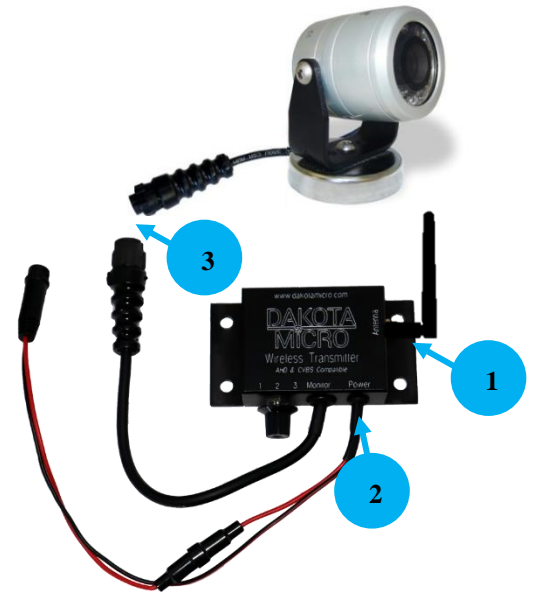

C. Receiver Installation

When being used with the Dakota Micro, Inc. H9Q monitor:

- 1) Attach supplied 3dBi antenna (1) or optional larger accessory antenna (details on page 5 of manual).
- 2) Plug the Dakota Micro receiver into the monitor wire harness.
- 3) Match the channel selector on the receiver to the camera you want to see.
- 4) To power the receiver, use either the hardware, 12v or AC adapter supplied.
- 5) To eliminate multiple power sources, you may use the available power output on the receiver to power the monitor.



IMPORTANT NOTE:

- **Use only the Dakota Micro provided power supplies.**

VIII. EMISSIONS NOTIFICATIONS

This equipment has been tested and found to comply with the limits for a Class B digital device, pursuant to Part 15 of the FCC Rules. These limits are designed to provide reasonable protection against harmful interference in a residential installation. This equipment generates uses and can radiate radio frequency energy and, if not installed and used in accordance with the instructions, may cause harmful interference to radio communications. However, there is no guarantee that interference will not occur in a particular installation. If this equipment does cause harmful interference to radio or television reception, which can be determined by turning the equipment off and on, the user is encouraged to try to correct the interference by one or more of the following measures:

- Reorient or relocate the receiving antenna.
- Increase the separation between the equipment and receiver.
- Connect the equipment into an outlet on a circuit different from that to which the receiver is connected.
- Consult the dealer or an experienced radio/TV technician for help.

In order to comply with FCC rules for protection against radio frequency exposure, this device must be installed in a manner to provide a minimum separation of 20cm (8") between the antenna and all persons.

Changes or modifications not expressly approved by Dakota Micro could void the user's authority to operate the equipment.

Canada

This device has been designed to operate with an antenna having a maximum gain of 15dBi. Antennas having a higher gain are strictly prohibited per regulations of Industry Canada. The required antenna impedance is 50 ohms.

Operation is subject to the following two conditions: (1) this device may not cause interference, and (2) this device must accept any interference, including interference that may cause undesired operation of the device.

To reduce potential radio interference to other users, the antenna type and its gain should be so chosen that the Equivalent Isotropically Radiated Power (EIRP) is not more than that required for successful communication.

The installer of this radio equipment must ensure that the antenna is located or pointed such that it does not emit RF field in excess of Health Canada limits for the general population; consult Safety Code 6, obtainable from Health Canada's website.

IX. SPECIFICATIONS

A. Transmitter	
Frequency	Ch1-2.411GHz / CH2-2.431GHz / CH3-2.451GHz
Channel	3 Selectable channels
Video Input Signal	AHD (Analog High Definition) or CVBS (analog) Video (NTSC or PAL)
Video Input Impedance	Video-75 ohms
A/V Connections	AgCam® / EnduraCam® camera connector
Antenna	Dipole Antenna (Detachable: Optional antennas available)
Operating Voltage	DC 9V-48V/3000mA power adaptor
Temp Limit	-45°F-150°F
B. Receiver	
Frequency	Ch1-2.411GHz / CH2-2.431GHz / CH3-2.451GHz
Channel	3 selectable channels
A/V Connections	AgCam® / EnduraCam® camera connector
Antenna	Dipole Antenna (Detachable: Optional antennas available)
Operating Voltage	DC 9V-48V/3000mA power adaptor

X. WARNINGS

- When selecting a camera system from Dakota Micro, be sure to utilize the appropriate system for your use. AgCam and EnduraCam cameras are designed for high impact, moisture, vibration and a variety of other rough conditions. OverView cameras and kit components are designed for light use, low vibration and low moisture. OverView equipment is not warranted when used in situations outside of the above mentioned parameters. We always request that customers keep in mind that our less expensive OverView product line is cheaper because it does not feature the reliability and durability of our AgCam and EnduraCam lines. The warranty available on these products reflects that durability.
- To avoid electrical shock and maintain optimal functionality, do not open the enclosures. High voltage may be present and there are no user serviceable parts inside. All warranties will be void should any enclosures be tampered with in any way.
- Do not use any harsh chemical solvents, cleaning agents or corrosive detergent to clean away dirt on the surface.
- Power to cameras is not interrupted by turning off monitor; 12v power source must be terminated when not in use to avoid battery drain.
- Do not use your Dakota Micro camera system for anything other than legal surveillance and observation uses. Dakota Micro, Inc. is not liable for any illegal or nefarious usage.

THIS PAGE
INTENTIONALLY
LEFT BLANK

XI. PRODUCT WARRANTY/REPAIR PROCESS

1. For Technical Support call 1 701-538-4403 OR email techsupport@dakotamicro.com
2. Technician will assist in troubleshooting product malfunction.
3. If product malfunction cannot be remedied and a repair is deemed necessary, Technician will issue a Repair Authorization (RA) number.

IMPORTANT NOTE:

The Technician will note on the RA form if the repair APPEARS to be a warranty or non-warranty issue based on customer description of the issues at hand. No final determination can be made until inspection and testing of the equipment is completed at the factory.

4. To ensure fast and effective repairs, customer is required to send:
 - Dakota Micro Product that Technician has requested/deemed necessary in the proper diagnosis and repair of malfunction. This may include some or all components of the kit.
 - Original/Copy of purchase receipt.
 - For serialized items ONLY: If a copy of the original purchase receipt cannot be provided, then DAKOTA MICRO will use the product manufacture date.
 - Customer information, including returns address & phone number. If the phone number is not included, the customer will be sent a letter requesting the needed information.
 - RA Number provided by Dakota Micro Technical Support
 - Shipping and associated costs to ship product to DM factory to be borne by the customer unless otherwise specified.
5. Customer should mail product to:

Dakota Micro, Inc.
RA # XXXXX
8659 148 ½ Ave. SE
Cayuga, ND 58013
6. Upon receipt and evaluation of product at Dakota Micro Factory, it will be established if the repair is warranty or non-warranty. If requested, customer will be called and notified of any applicable charges.
7. If the repairs are deemed non-warranty and require a service/repair fee of any kind, a credit card number will be requested by Order Processing after the repair is completed.
8. If customer is unable to be contacted over the course of 3 weeks regarding required non-warranty repairs, product will be returned, unrepared, to the customer.
9. Any product returned without proper documentation may be returned at customer's expense.
10. Product returned with unconfirmed problems will be assessed a \$60 evaluation fee per unit
11. Return shipping costs will be borne by the party at fault; in other words, if Dakota Micro determines that the defective product was covered under warranty, Dakota Micro pays the shipping charges. If Dakota Micro determines that it was the customers fault, the customer will pay shipping charges. If a particular circumstance cannot be determined than the cost of shipping charges will be decided on a discretionary basis depending on the situation at hand.

XII. CONSUMER LIMITED WARRANTY

Subject to the disclaimer, limitations and other directions stated hereafter, Dakota Micro, Inc. warrants that the Product will be free from defects in material and workmanship for periods as stated hereafter from the date of original purchase. **THIS WARRANTY IS EXPRESSLY MADE IN LIEU OF ANY AND ALL OTHER WARRANTIES, EXPRESS OR IMPLIED, INCLUDING THE IMPLIED WARRANTIES OF MERCHANTABILITY OR FITNESS. THE EXCLUSIVE REMEDY OF THE BUYER IS LIMITED TO REPAIR OR REPLACEMENT OF THE PRODUCT. EXCEPT AS STATED IN THIS WARRANTY, DAKOTA MICRO SHALL NOT BE LIABLE FOR ANY LOSS, INCONVENIENCE, OR DAMAGE, INCLUDING DIRECT, SPECIAL, INCIDENTAL, OR CONSEQUENTIAL DAMAGES, RESULTING FROM THE USE OR INABILITY TO USE THE PRODUCT, WHETHER RESULTING FROM BREACH OF WARRANTY, NEGLIGENCE, STRICT LIABILITY OF ANY OTHER LEGAL THEORY.** Any oral statements or representations made by anyone which are contrary to or at variance with the terms stated in this **LIMITED WARRANTY** are void.

Dakota Micro will, at its option, either repair the defect or replace the defective Product or part thereof with a new or remanufactured equivalent at no charge to the purchaser for parts or labor for the period of three (3) years for AgCam® /EnduraCam® and InnoPro® cameras; two (2) years for AgCam®/ EnduraCam® monitors, and Wireless components; Twelve Months (12) for all Overview Cameras & Monitors, cables and all other accessories.

The Dakota Micro limited warranty periods outlined above apply throughout the United States and Canada only. A one (1) year maximum limited warranty for all Products applies to all other geographic locations unless otherwise stated in writing by Dakota Micro.

This limited warranty does not apply to any issues connected with appearance that have no relation to the performance of the Product nor to any Product the exterior of which has been damaged or defaced, which has been subjected to improper voltage or other misuse, abnormal service or handling, or which has been altered or modified in design or construction.

In order to enforce the rights under this limited warranty, the purchaser should follow the steps set forth in the complete Dakota Micro “Warranty & Repair Policy” listed on page 11 - section XV , and provide proof of purchase to Dakota Micro.

Neither the sales personnel of Dakota Micro nor any dealer or any other person is authorized to make any warranties other than those described herein, or to extend the duration of any warranties beyond the time periods described herein.

The warranties described herein shall be the sole and exclusive warranties and remedies provided by Dakota Micro. Correction of defects, in the manner and for the period of time described herein, shall constitute complete fulfillment of all liabilities and responsibilities of Dakota Micro to the purchaser with respect to the Product, and shall constitute full satisfaction of all claims. In no event shall Dakota Micro be liable or in any way responsible for any damages or defects in the Product which were caused by repairs or attempted repairs performed by anyone other than Dakota Micro.

Some states do not allow the limitation or exclusion of incidental or consequential damages, so said limitation may not apply to you.

Any action at law, suit in equity, or other judicial proceeding for the enforcement of any right provided for herein or otherwise, or with respect to any claim that a purchaser may have against Dakota Micro shall be instituted only in the Courts of the State of North Dakota, either in the state district court located in Wahpeton, North Dakota or in Federal District Court location in Fargo, North Dakota. Without regard to conflicts of law principles, the laws of the state of North Dakota shall govern the interpretation and enforcement of the terms of this Limited Warranty and all aspects of the relationship between Dakota Micro and the purchaser.

This warranty gives you specific legal rights and you may also have other rights, which may vary from state to state.

XIII. DISCLAIMER

Dakota Micro Inc. products, specifications, pricing and programs are subject to change without prior notice. Dakota Micro Inc. reserves the right to make design changes at any time without obligation to retroactively install them on previously sold units.

XIV. CONTACT US



8659 148 ½ Ave. SE.

Cayuga, ND 58013

Management System Registered to ISO 9001

www.dakotamicro.com