



### Typical Applications

The HMC491LP3 / HMC491LP3E is ideal for:

- Wireless Local Loop (WLL)
- Fixed Wireless Access
- Microwave & VSAT Radios

### Features

- Gain: 16 dB
- Noise Figure: 2 dB
- Single Supply: +3V @ 9 mA
- Integrated Bypass Mode
- 50 Ohm Matched Input/Output
- 3 x 3 x 1 mm QFN SMT Package

### Functional Diagram

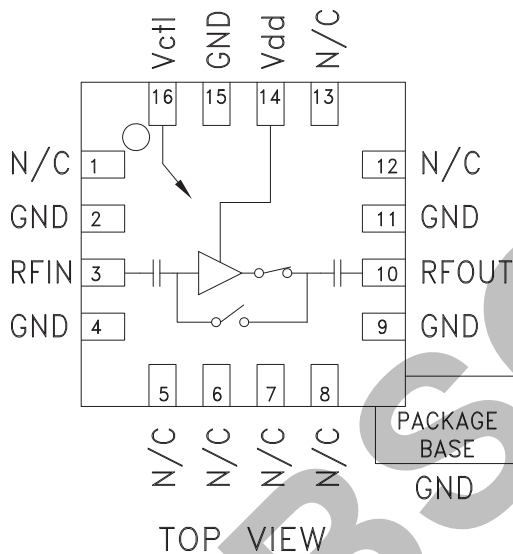

### General Description

The HMC491LP3 & HMC491LP3E are versatile, integrated, Low Noise Amplifiers (LNA) featuring a bypass mode intended for 3.4 to 3.8 GHz Fixed Wireless & WLL applications. The amplifier provides 16 dB of gain, 2 dB noise figure and +3 dBm input IP3 while requiring only 9 mA from a +3V supply. Using a single control line, the LNA can be switched into a low loss 2.2 dB bypass mode reducing the current consumption to 20  $\mu$ A. A low cost, leadless 3x3 mm QFN surface mount package (LP3) houses the amplifier. No external RF matching components are required.

### Electrical Specifications, $T_A = +25^\circ\text{C}$ , $V_{dd} = +3V$

Parameter	LNA Mode			LNA Mode			Bypass Mode			Units
	Min.	Typ.	Max.	Min.	Typ.	Max.	Min.	Typ.	Max.	
Frequency Range	3.4 - 3.6			3.6 - 3.8			3.4 - 3.8			GHz
Gain	14.5	17		13	15.5		-2.8	-2.3		dB
Gain Variation Over Temperature		0.012	0.02		0.012	0.02		0.004	0.008	dB / $^\circ\text{C}$
Noise Figure		2.2	2.7		2.0	2.5		--	--	dB
Input Return Loss		12			17			18		dB
Output Return Loss		9			7			11		dB
Reverse Isolation		34			33			--		dB
Input or Output Power for 1dB Compression (P1dB)*	3	6		4	7		25	28		dBm
Input Third Order Intercept (IP3) (-20 dBm Input Power per tone, 1 MHz tone spacing)		1			3			11		dBm
Supply Current (I <sub>dd</sub> )		9			9			0.03		mA

\* P1dB for LNA Mode is referenced to RFOUT while P1dB for Bypass Mode is referenced to RFIN.



**GaAs MMIC LOW NOISE AMPLIFIER  
w/ BYPASS MODE, 3.4 - 3.8 GHz**

**LNA Mode  
Broadband Gain & Return Loss**

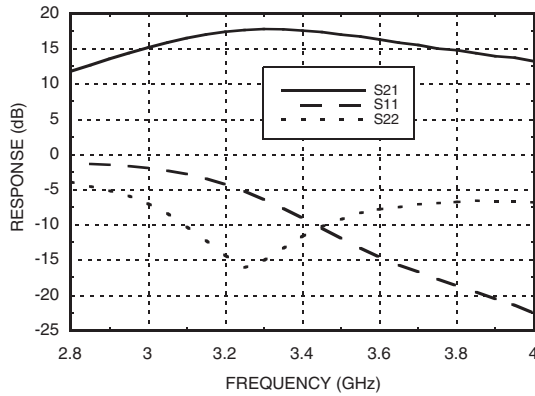

**LNA Mode  
Gain vs. Temperature**

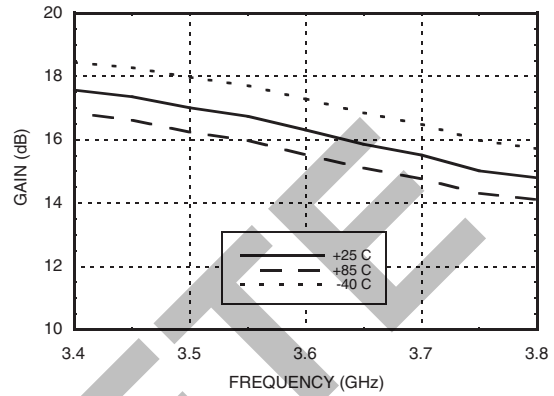

**LNA Mode  
Input Return Loss vs. Temperature**

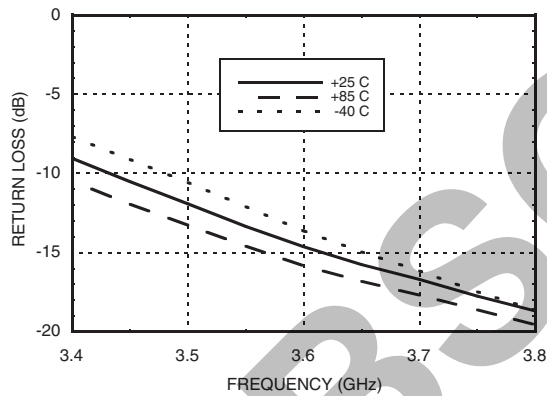

**LNA Mode  
Output Return Loss vs. Temperature**

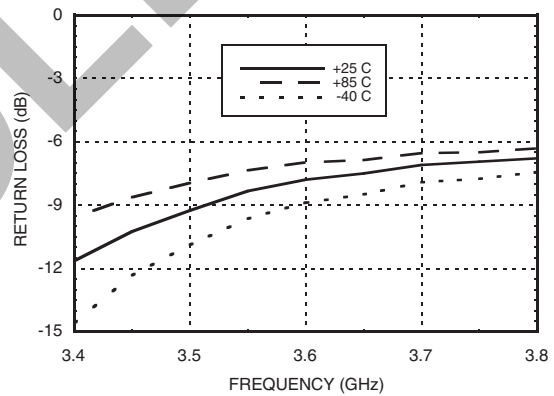

**LNA Mode  
Noise Figure vs. Temperature**

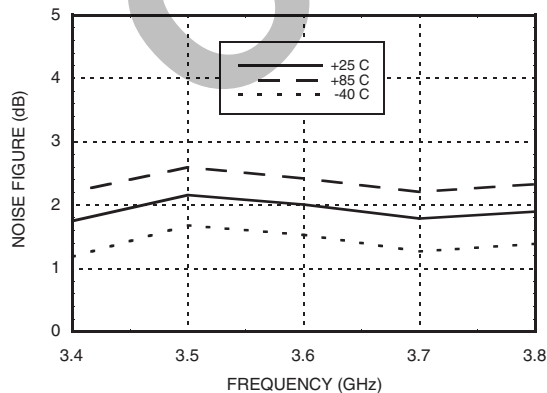

**LNA Mode  
Reverse Isolation vs. Temperature**

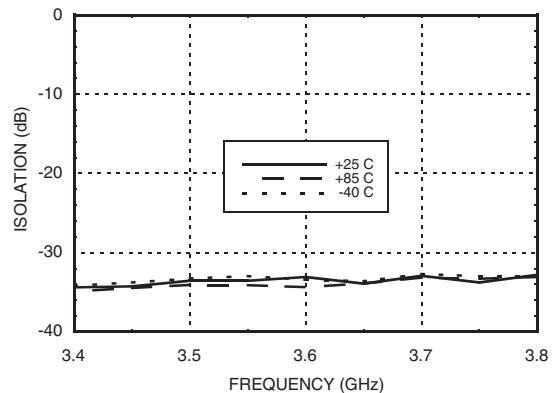

Information furnished by Analog Devices is believed to be accurate and reliable. However, no responsibility is assumed by Analog Devices for its use, nor for any infringements of patents or other rights of third parties that may result from its use. Specifications subject to change without notice. No license is granted by implication or otherwise under any patent or patent rights of Analog Devices. Trademarks and registered trademarks are the property of their respective owners.

For price, delivery, and to place orders: Analog Devices, Inc., One Technology Way, P.O. Box 9106, Norwood, MA 02062-9106 Phone: 781-329-4700 • Order online at [www.analog.com](http://www.analog.com) Application Support: Phone: 1-800-ANALOG-D



**GaAs MMIC LOW NOISE AMPLIFIER  
w/ BYPASS MODE, 3.4 - 3.8 GHz**

8

LOW NOISE AMPLIFIERS - SMT

**LNA Mode  
Output P1dB vs. Temperature**

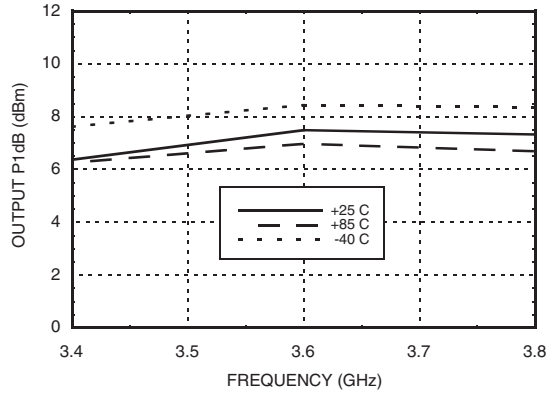

**LNA Mode  
Psat vs. Temperature**

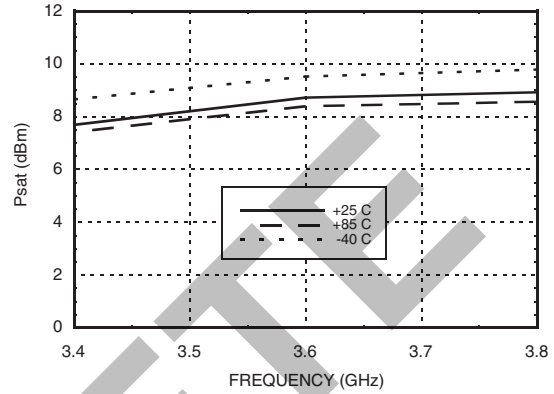

**LNA Mode  
Input IP3 vs. Temperature**

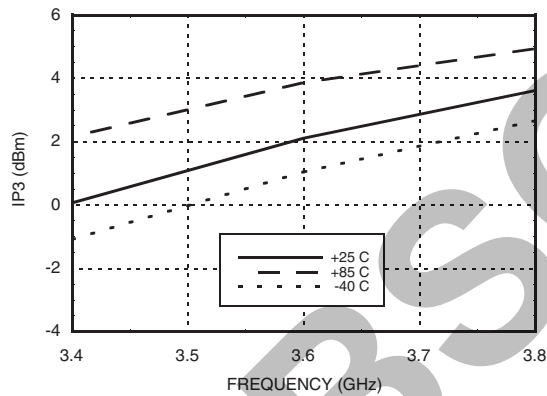

**LNA Mode Gain, Noise Figure & Supply Current vs. Supply Voltage @ 3.6 GHz**

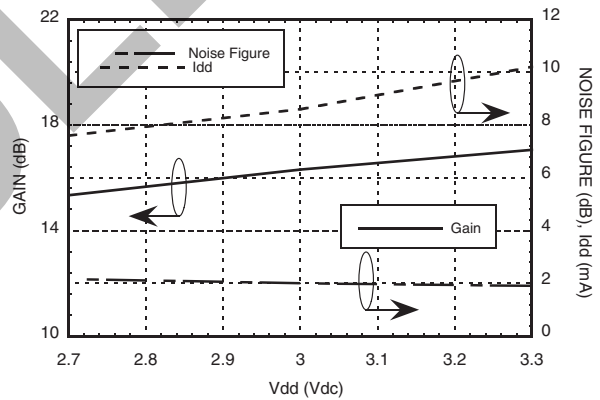

**Bypass Mode  
Broadband Insertion Loss & Return Loss**

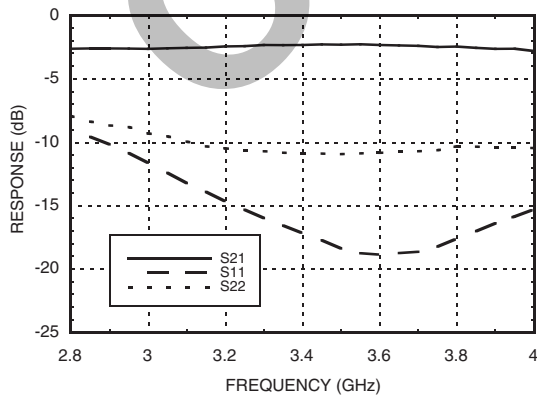

**Bypass Mode  
Insertion Loss vs. Temperature**

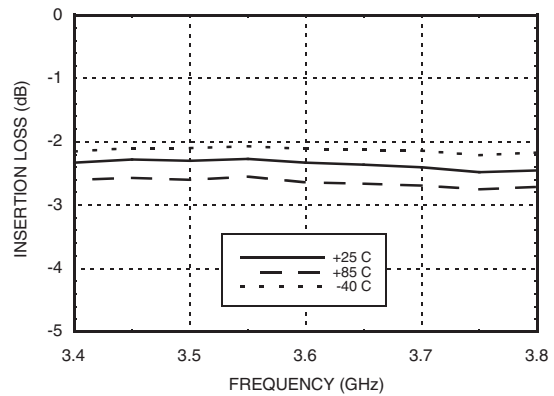

Information furnished by Analog Devices is believed to be accurate and reliable. However, no responsibility is assumed by Analog Devices for its use, nor for any infringements of patents or other rights of third parties that may result from its use. Specifications subject to change without notice. No license is granted by implication or otherwise under any patent or patent rights of Analog Devices. Trademarks and registered trademarks are the property of their respective owners.

For price, delivery, and to place orders: Analog Devices, Inc., One Technology Way, P.O. Box 9106, Norwood, MA 02062-9106 Phone: 781-329-4700 • Order online at [www.analog.com](http://www.analog.com) Application Support: Phone: 1-800-ANALOG-D



## GaAs MMIC LOW NOISE AMPLIFIER w/ BYPASS MODE, 3.4 - 3.8 GHz

**Bypass Mode**  
**Input Return Loss vs. Temperature**

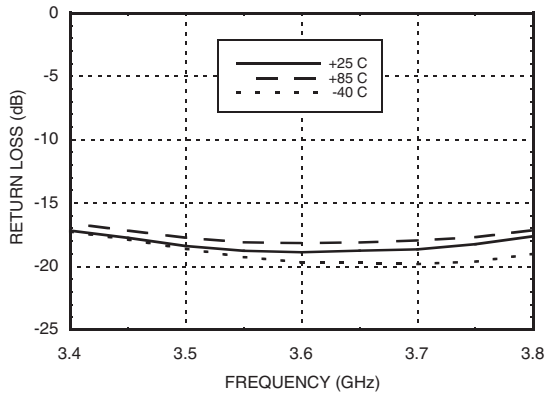

**Bypass Mode**  
**Output Return Loss vs. Temperature**

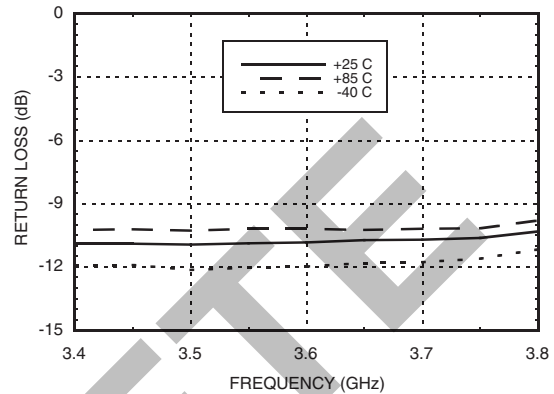

**Bypass Mode**  
**Input IP3 vs. Temperature**

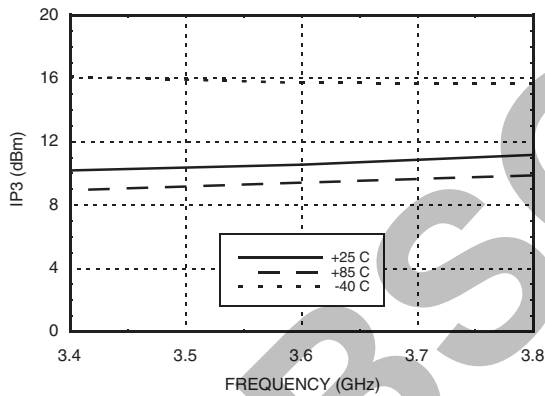

**Bypass Mode**  
**Input P1dB vs. Temperature**

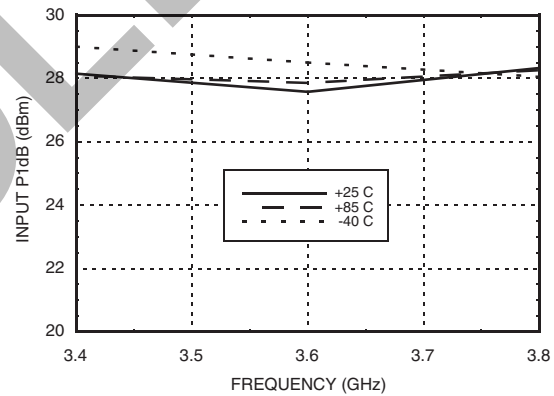

### Absolute Maximum Ratings

Drain Bias Voltage (Vdd)	+7.0 Vdc
RF Input Power (RFIN)	LNA Mode 0 dBm
(Vdd = +3.0 Vdc)	Bypass Mode +30 dBm
Channel Temperature	150 °C
Continuous Pdiss (T = 85 °C) (derate 1.8 mW/°C above 85 °C)	0.117 W
Thermal Resistance (channel to ground paddle)	556 °C/W
Storage Temperature	-65 to +150 °C
Operating Temperature	-40 to +85 °C

### Typical Supply Current vs. Vdd

Vdd (Vdc)	Idd (mA)
+2.7	7.6
+3.0	9.0
+3.3	10.2

### Truth Table

LNA Mode	Vctl= Vdd @ 1.6 mA
Bypass Mode	Vctl= 0Vdc @ -13 μA
Vdd= +3V ±10%	



**ELECTROSTATIC SENSITIVE DEVICE**  
**OBSERVE HANDLING PRECAUTIONS**

## GaAs MMIC LOW NOISE AMPLIFIER w/ BYPASS MODE, 3.4 - 3.8 GHz



### Outline Drawing

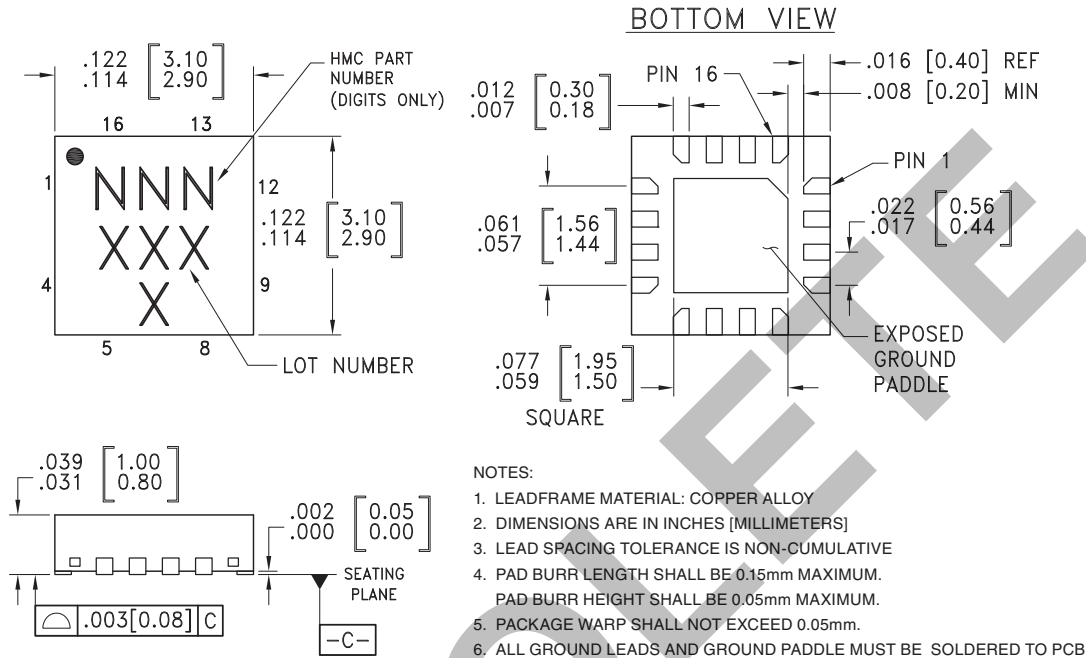

### Package Information

Part Number	Package Body Material	Lead Finish	MSL Rating	Package Marking <sup>[3]</sup>
HMC491LP3	Low Stress Injection Molded Plastic	Sn/Pb Solder	MSL1 <sup>[1]</sup>	491 XXXX
HMC491LP3E	RoHS-compliant Low Stress Injection Molded Plastic	100% matte Sn	MSL1 <sup>[2]</sup>	491 XXXX

[1] Max peak reflow temperature of 235 °C  
 [2] Max peak reflow temperature of 260 °C  
 [3] 4-Digit lot number XXXX

### Pin Descriptions

Pin Number	Function	Description	Interface Schematic
1, 5 - 8, 12, 13	N/C	No connection necessary. These pins may be connected to RF/DC ground.	
2, 4, 9, 11, 15	GND	These pins must be connected to RF/DC ground.	
3	RF IN	This pin is AC coupled and matched to 50 Ohms.	
10	RF OUT	This pin is AC coupled and matched to 50 Ohms.	
14	Vdd	Power supply voltage.	
16	Vctl	Control voltage. Vctl= Vdd for LNA mode. Vctl= 0V for bypass mode.	

Information furnished by Analog Devices is believed to be accurate and reliable. However, no responsibility is assumed by Analog Devices for its use, nor for any infringements of patents or other rights of third parties that may result from its use. Specifications subject to change without notice. No license is granted by implication or otherwise under any patent or patent rights of Analog Devices. Trademarks and registered trademarks are the property of their respective owners.

For price, delivery, and to place orders: Analog Devices, Inc., One Technology Way, P.O. Box 9106, Norwood, MA 02062-9106  
 Phone: 781-329-4700 • Order online at [www.analog.com](http://www.analog.com)  
 Application Support: Phone: 1-800-ANALOG-D



**Evaluation PCB**

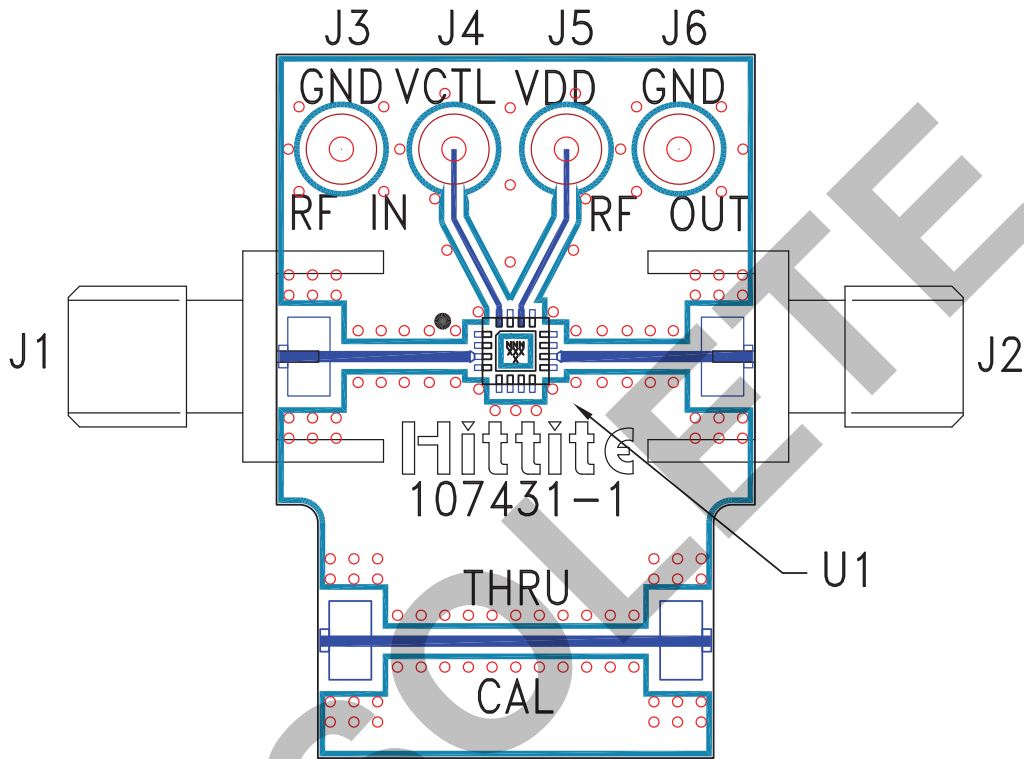

**List of Materials for Evaluation PCB 107174 [1]**

Item	Description
J1 - J2	PCB Mount SMA RF Connector
J3 - J6	DC Pin
U1	HMC491LP3 / HMC491LP3E Amplifier
PCB [2]	107431 Evaluation PCB

[1] Reference this number when ordering complete evaluation PCB

[2] Circuit Board Material: Rogers 4350

The circuit board used in the final application should use RF circuit design techniques. Signal lines should have 50 ohm impedance while the package ground leads and exposed paddle should be connected directly to the ground plane similar to that shown. A sufficient number of via holes should be used to connect the top and bottom ground planes. The evaluation circuit board shown is available from Hittite upon request.