

Low Dropout, Negative Output Voltage Regulator

Features

- Low Dropout Voltage
 - Typically 120mV @ 50mA; 380mV @ 100mA for -5.0V Output Part
- Tight Output Voltage Tolerance: $\pm 2\%$ Max
- Low Supply Current: 3.5 μ A, Typ
- Small Package: 3-Pin SOT-23A

Applications

- Cellular Phones
- Battery Operated Systems
- Palmtops
- Portable Cameras

Device Selection Table

Part Number	Output Voltage	Package	Temperature Range
TC593002ECB	3.0V	3-Pin SOT-23A	-40°C to +85°C
TC595002ECB	5.0V	3-Pin SOT-23A	-40°C to +85°C

Other output voltages are available. Please contact Microchip Technology Inc. for details.

Package Type

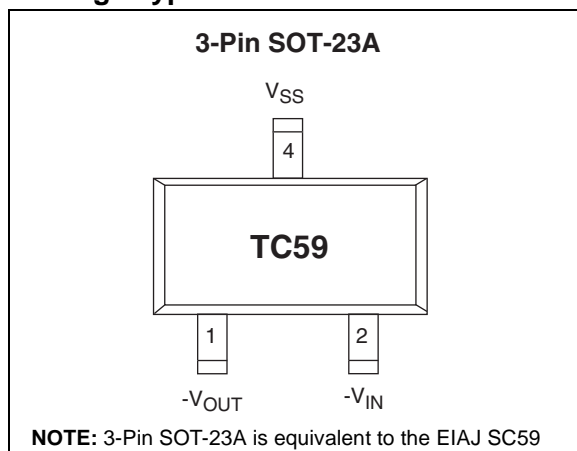

General Description

The TC59 is a low dropout, negative output voltage regulator designed specifically for battery-operated systems. Its full CMOS construction eliminates the wasted ground current typical of bipolar LDOs. This reduced supply current significantly extends battery life, particularly when the TC59 is operated in dropout.

Other TC59 key features include low supply current (typically 3.0 μ A) and low dropout operation (typically 120mV at 50mA). The TC59 is packaged in a small 3-Pin SOT-23A package.

Functional Block Diagram

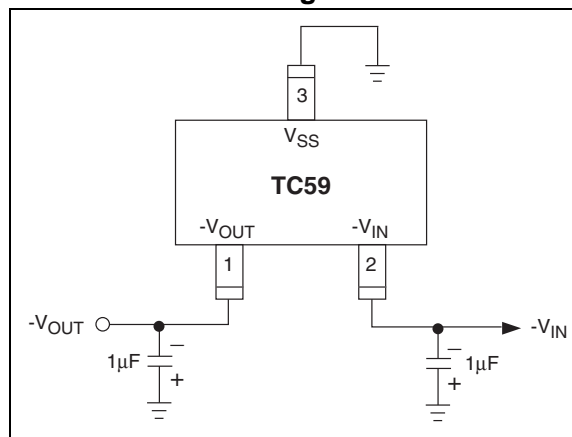

TC59

1.0 ELECTRICAL CHARACTERISTICS

Absolute Maximum Ratings*

Input Voltage	-12V
Output Current	200mA
Output Voltage.....	$-V_{DD} - 0.3V$ to $V_{IN} + 0.3V$
Power Dissipation.....	150mW
Operating Temperature Range.....	-40°C to +85°C
Storage Temperature Range	-40°C to +125°C

Stresses above those listed under "Absolute Maximum Ratings" may cause permanent damage to the device. These are stress ratings only and functional operation of the device at these or any other conditions above those indicated in the operation sections of the specifications is not implied. Exposure to Absolute Maximum Rating conditions for extended periods may affect device reliability.

TC59 ELECTRICAL SPECIFICATIONS

Electrical Characteristics: $V_{IN} = V_R - 1.0V$ (Note 1), $C_L = 10\mu F$, $T_A = 25^\circ C$ unless otherwise noted.						
Symbol	Parameter	Min	Typ	Max	Units	Test Conditions
V_{IN}	Input Voltage	—	—	-10	V	$I_{OUT} = 20mA$
I_{DD}	Supply Current	—	3	7	μA	
$I_{OUT(MAX)}$	Maximum Output Current	100 80 60	— — —	— — —	mA mA mA	$V_{IN} = -6.0V; V_R = -5.0V, V_{OUT} \leq -4.5V$ $V_{IN} = -5.0V; V_R = -4.0V, V_{OUT} \leq -3.6V$ $V_{IN} = -4.0V; V_R = -3.0V, V_{OUT} \leq -2.7V$
V_{OUT}	Output Voltage	$1.02 \times V_R$	—	$0.98 \times V_R$	V	$I_{OUT} = 20mA$
TC V_{OUT}	Output Voltage Temperature Coefficient	—	± 100	—	ppm/ $^\circ C$	$I_{OUT} = 20mA$
$\frac{\Delta V_{OUT}}{(\Delta V_{IN} \times V_{OUT})}$	Line Regulation	—	0.1	0.3	%/V	$I_{OUT} = 20mA; V_R = -5.0V; -6.0 < V_{IN} < -10.0V$ $V_R = -4.0V; -5.0 < V_{IN} < -10.0V$ $V_R = -3.0V; -4.0 < V_{IN} < -10.0V$
ΔV_{OUT}	Load Regulation	—	40	80	mV	$V_R = -5.0V; 1mA < I_{OUT} < 50mA$ $V_R = -4.0V; 1mA < I_{OUT} < 45mA$ $V_R = -3.0V; 1mA < I_{OUT} < 40mA$
$V_{IN} - V_{OUT}$	Dropout Voltage	— — — — — —	120 380 120 380 120 380	300 600 300 600 300 600	mV mV mV mV mV mV	$V_R = -5.0V; I_{OUT} = 50mA$ $I_{OUT} = 100mA$ $V_R = -4.0V; I_{OUT} = 45mA$ $I_{OUT} = 90mA$ $V_R = -3.0V; I_{OUT} = 40mA$ $I_{OUT} = 80mA$

Note 1: V_R is the regulator output voltage setting. For example: $V_R = -2.5V, -2.7V, -3.0V, -3.3V, -3.6V, -4.0V, -5.0V$.

2.0 PIN DESCRIPTIONS

The descriptions of the pins are listed in Table 2-1.

TABLE 2-1: PIN FUNCTION TABLE

Pin No. (3-Pin SOT-23A)	Symbol	Description
1	V_{OUT}	Regulated voltage output.
2	V_{IN}	Supply voltage input.
3	V_{SS}	Ground.

3.0 DETAILED DESCRIPTION

The TC59 is a low quiescent current, precision fixed negative output voltage LDO. Unlike bipolar linear regulators, the TC59 supply current does not increase proportionally with load current.

3.1 Output Capacitor

A minimum of 1 μ F tantalum output capacitor is required. The requirements for the output capacitor are an equivalent series resistance (esr) greater than 0.1 Ω and less than 5 Ω , with a self-resonant frequency greater than 1MHz. To improve supply noise rejection and transient response, larger output capacitors can be used. Care should be taken when increasing C_{OUT} , that the input impedance is not high enough to cause high input impedance oscillation.

3.2 Input Capacitor

A 1 μ F input capacitor is recommended for most applications when the input impedance is on the order of 10 Ω . When operating off of a battery input, or there is a large distance from the input source to the LDO, larger input capacitance may be required for stability. When large values of output capacitance are used, the input capacitance should be increased to prevent high source impedance oscillations.

4.0 THERMAL CONSIDERATIONS

4.1 Power Dissipation

The amount of power dissipated internal to the low drop out linear regulator is the sum of the power dissipation within the linear pass device (P-Channel MOSFET), and the quiescent current required to bias the internal reference and error amplifier. The internal linear pass device power dissipation is calculated multiplying the voltage across the linear device times the current through the device. The input and output voltages are negative for the TC59. The power dissipation is calculated using the absolute value of the voltage difference between the input and output voltage.

TABLE 4-1: MAXIMUM POWER DISSIPATION

Package Type	Maximum Power Dissipation
SOT-23-3	150mW

EQUATION 4-1:

$$P_D (\text{Pass Device}) = (V_{IN} - V_{OUT}) \times I_{OUT}$$

The internal power dissipation as a result of the bias current for the LDO internal reference and error amplifier is calculated by multiplying the ground or quiescent current times the input voltage.

EQUATION 4-2:

$$P_D (\text{Bias}) = V_{IN} \times I_{GND}$$

The total internal power dissipation is the sum of Equation 4-1 and Equation 4-2.

EQUATION 4-3:

$$P_{TOTAL} = P_D (\text{Pass Device}) + P_D (\text{Bias})$$

For the TC59, the internal quiescent bias current is so low (3μA typical), the P_D (Bias) term of the power dissipation equation can be ignored. The maximum power dissipation can be estimated by using the maximum input voltage and the minimum output voltage to obtain a maximum voltage differential between input and output and multiplying the maximum voltage differential by the maximum output current.

EQUATION 4-4:

$$P_{MAX} = (V_{IN (MAX)} - V_{OUT (MIN)}) \times I_{OUT (MAX)}$$

For example, given the following conditions:

$$V_{IN} = -7.0V \pm 5\%$$

$$V_{OUT} = -5.0V \pm 2\%$$

$$I_{OUT} = 1mA \text{ to } 40mA$$

$$T_{AMBIENT (MAX)} = 55^\circ C$$

$$P_{MAX} = (7V \times (1.05) - (5.0V \times 0.98)) \times 40mA$$

$$P_{MAX} = 98.0 \text{ milli-Watts}$$

To determine the junction temperature of the device, the thermal resistance from junction to air must be known. The SOT-23-3 $R_{\theta JA}$ is estimated to be approximately 359°C/W when mounted on a 4-layer board. The $R_{\theta JA}$ will vary with physical layout, airflow and other application specific conditions.

The device junction temperature is determined by calculating the junction temperature rise above ambient, then adding the rise to the ambient temperature.

EQUATION 4-5: JUNCTION TEMPERATURE (SOT-23 EXAMPLE)

$$T_{JUNCTION} = P_D (MAX) \times R_{\theta JA} + T_{AMBIENT}$$

$$T_{JUNCTION} = 98.0 \text{ milli-Watts} \times 359^\circ C/W + 55^\circ C$$

$$T_{JUNCTION} = 90.2^\circ C$$

5.0 TYPICAL CHARACTERISTICS

Note: The graphs and tables provided following this note are a statistical summary based on a limited number of samples and are provided for informational purposes only. The performance characteristics listed herein are not tested or guaranteed. In some graphs or tables, the data presented may be outside the specified operating range (e.g., outside specified power supply range) and therefore outside the warranted range.

1. OUTPUT VOLTAGE vs. OUTPUT CURRENT

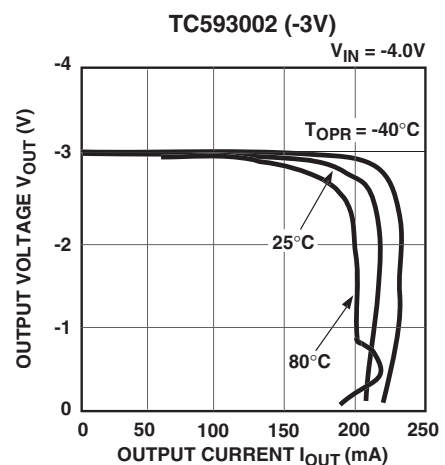
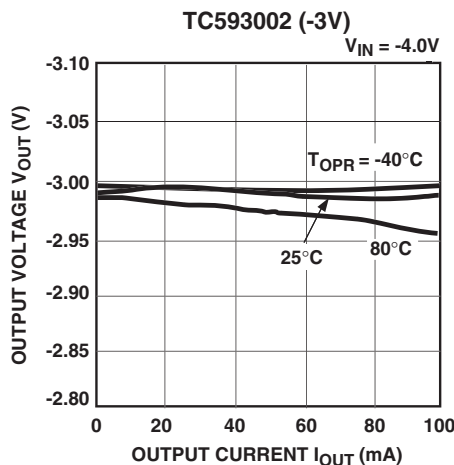
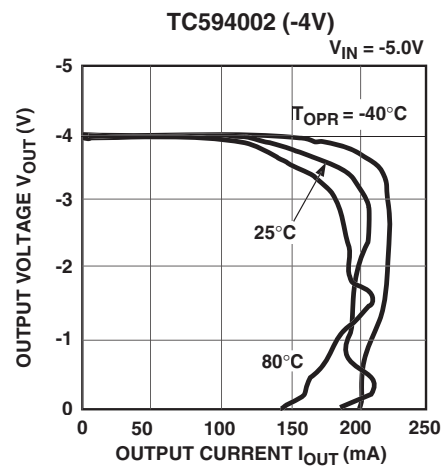
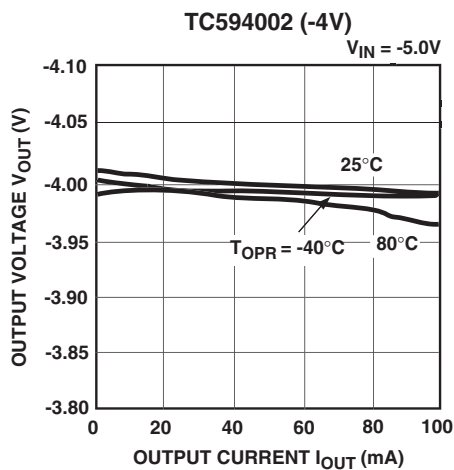
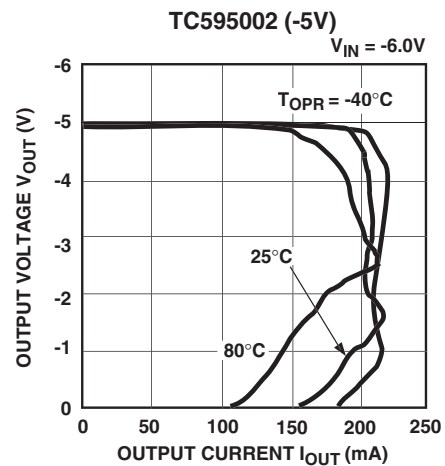
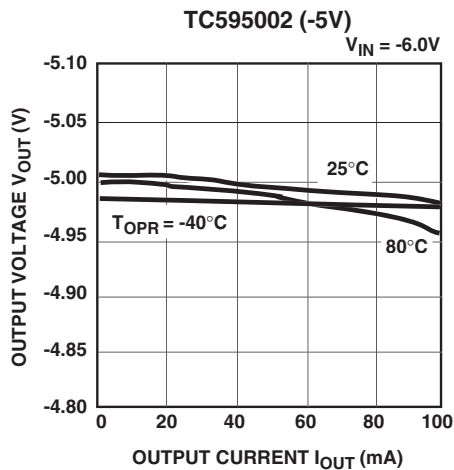

5.0 TYPICAL CHARACTERISTICS (CONTINUED)

2. OUTPUT VOLTAGE vs. INPUT VOLTAGE

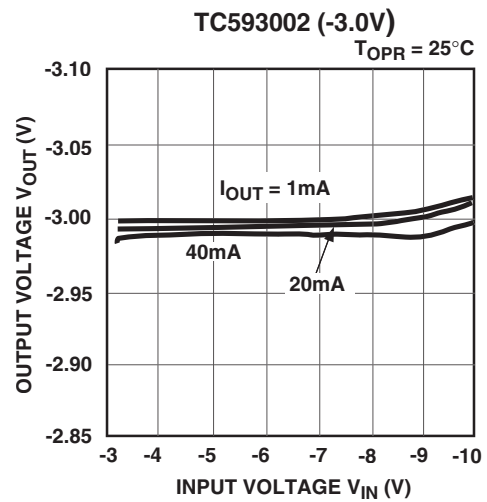
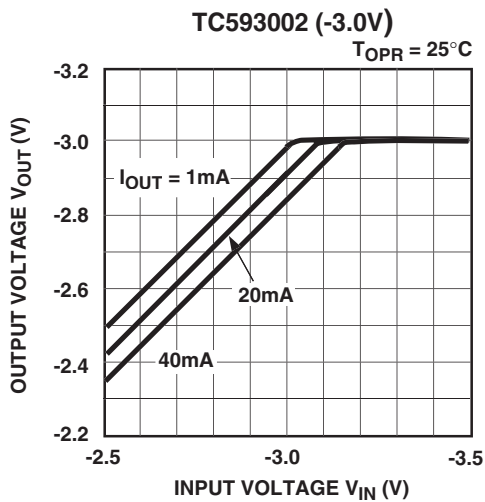
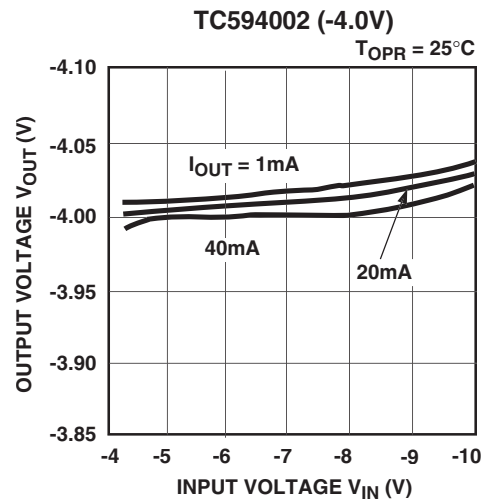
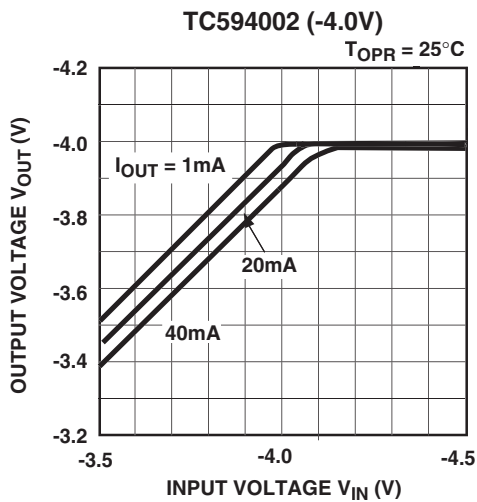
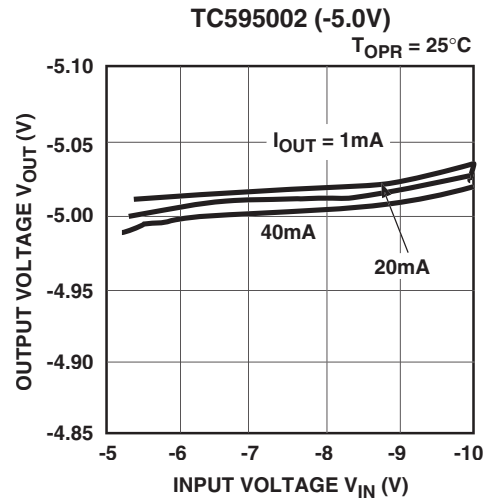
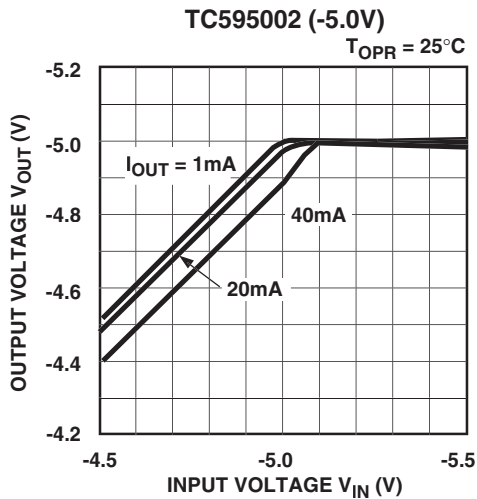

5.0 TYPICAL CHARACTERISTICS (CONTINUED)

3. INPUT/OUTPUT VOLTAGE DIFFERENTIAL vs. OUTPUT CURRENT

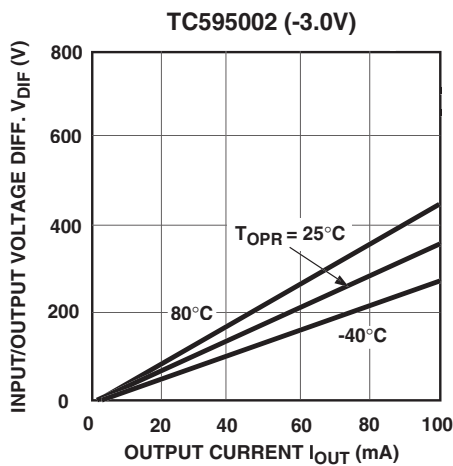
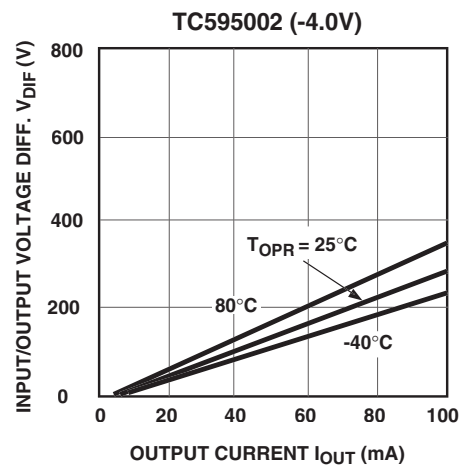
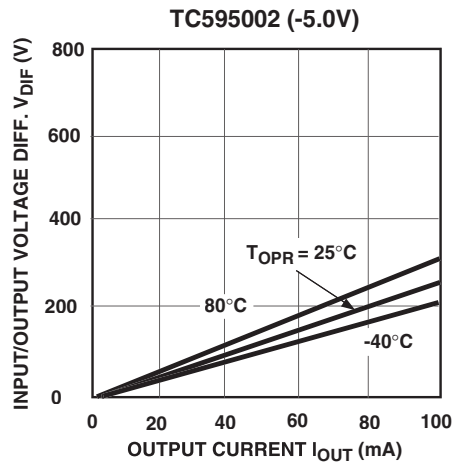

4. SUPPLY CURRENT vs. INPUT VOLTAGE

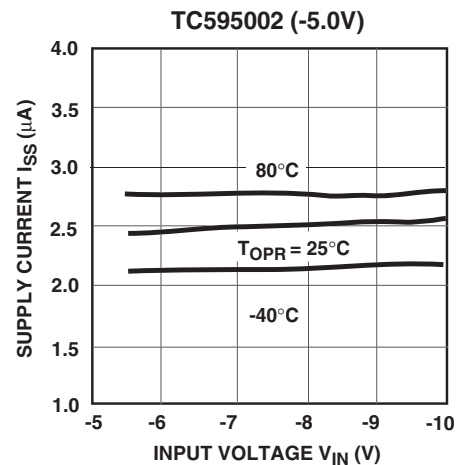
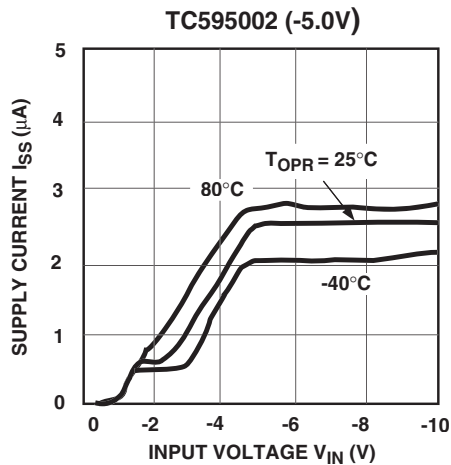

5.0 TYPICAL CHARACTERISTICS (CONTINUED)

4. SUPPLY CURRENT vs. INPUT VOLTAGE (CONTINUED)

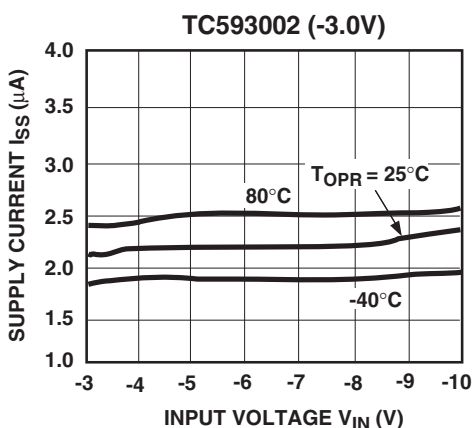
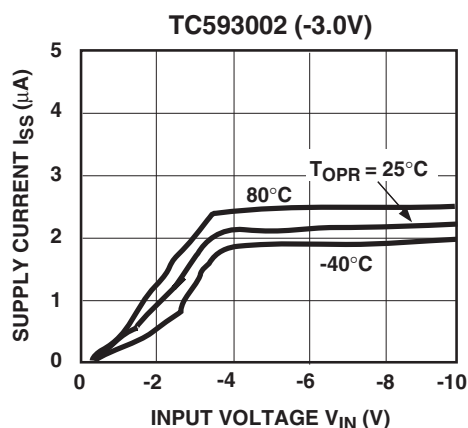
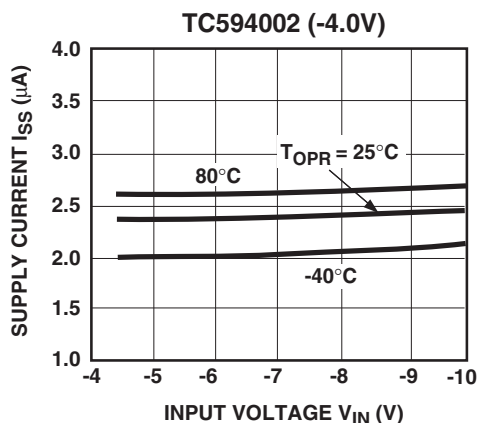
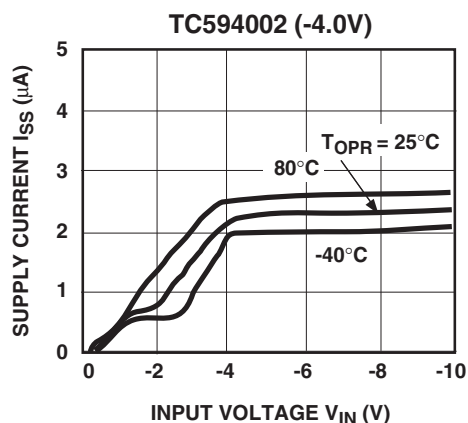

5. OUTPUT VOLTAGE vs. AMBIENT TEMPERATURE

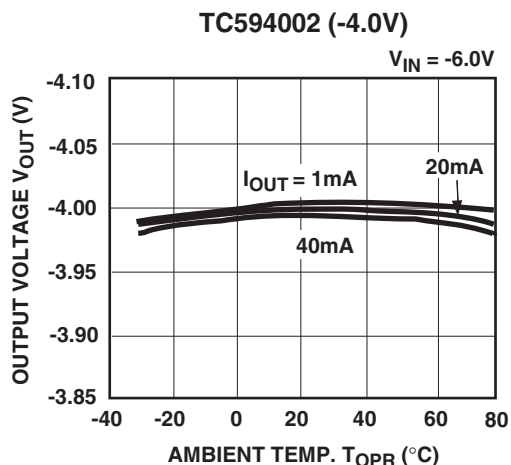
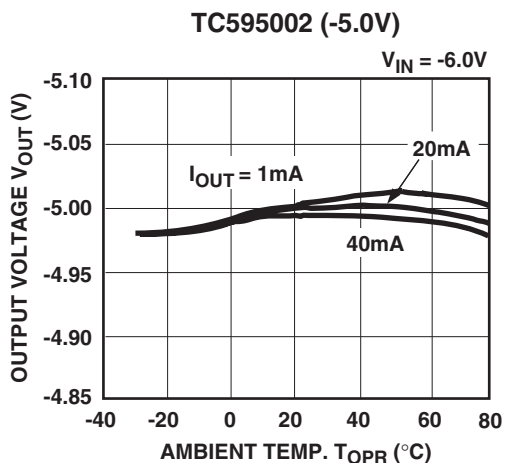

5.0 TYPICAL CHARACTERISTICS (CONTINUED)

5. OUTPUT VOLTAGE vs. AMBIENT TEMPERATURE (CONTINUED)

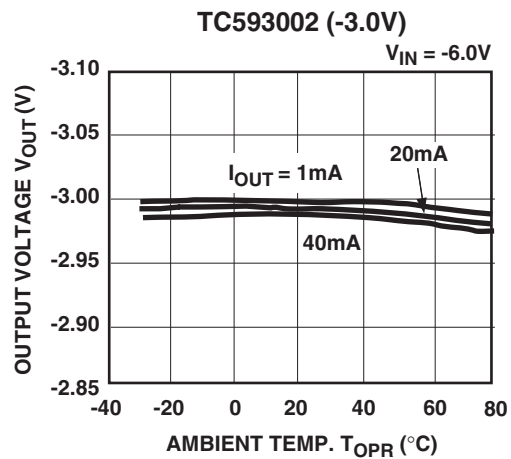

6. SUPPLY CURRENT vs. AMBIENT TEMPERATURE

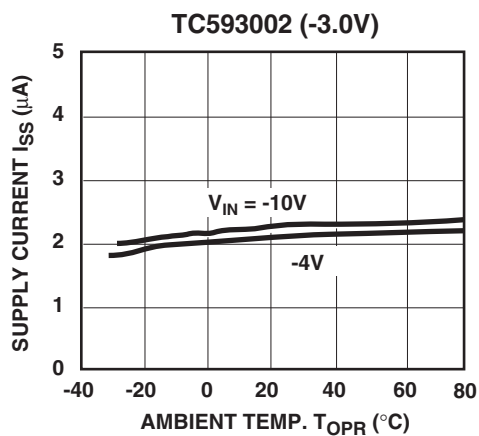
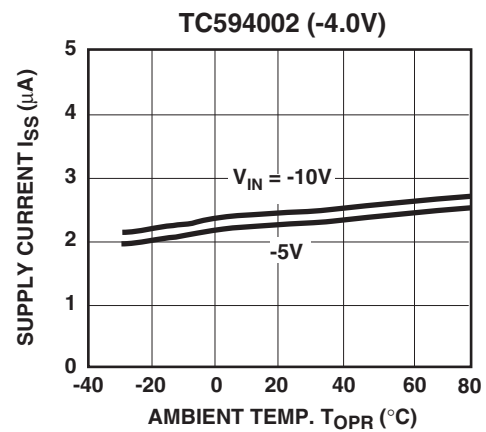
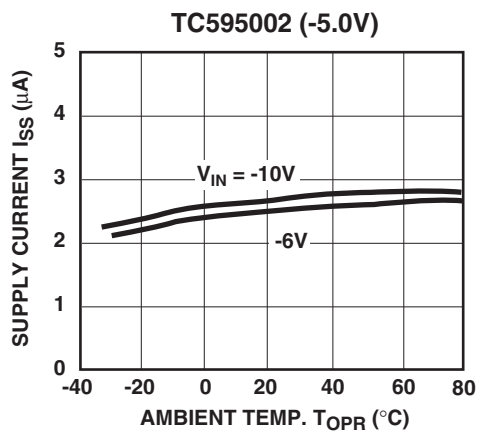

5.0 TYPICAL CHARACTERISTICS (CONTINUED)

7. INPUT TRANSIENT RESPONSE

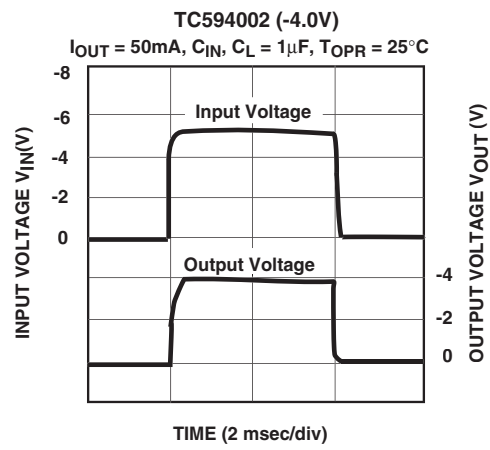
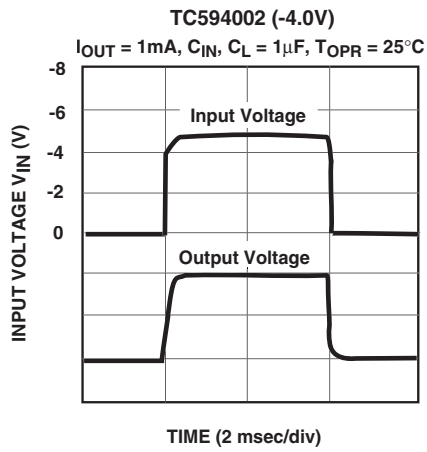
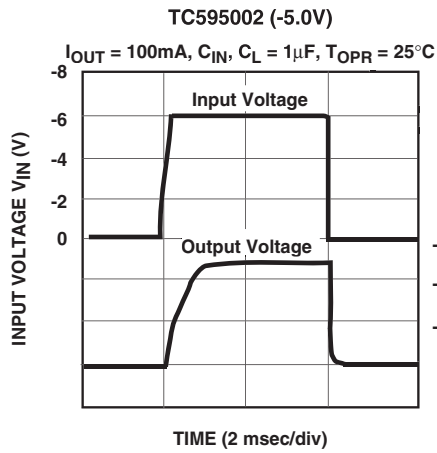
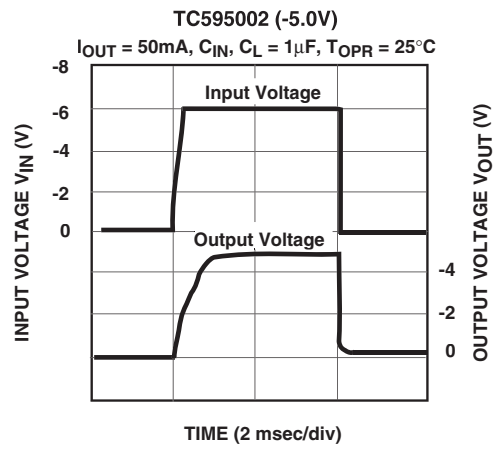
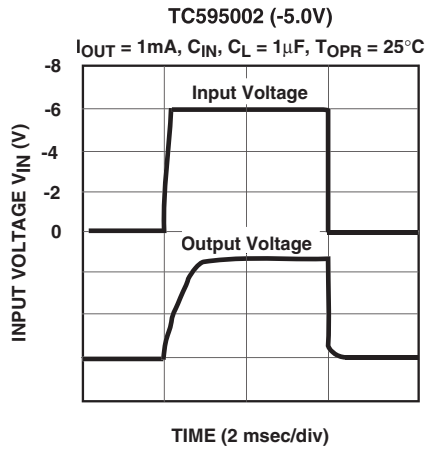

5.0 TYPICAL CHARACTERISTICS (CONTINUED)

7. INPUT TRANSIENT RESPONSE (CONT.)

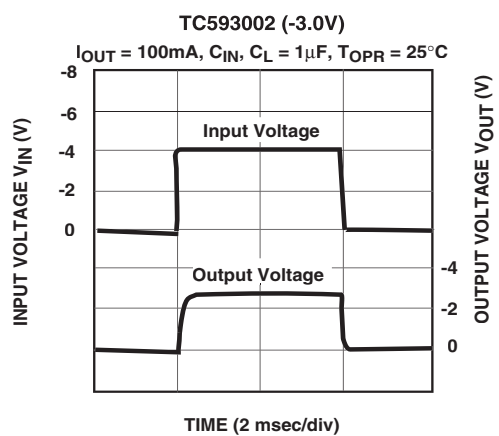
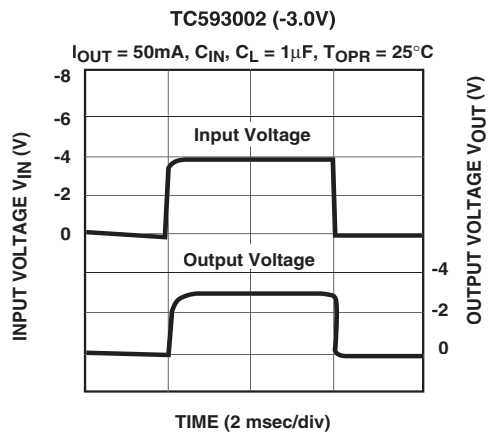
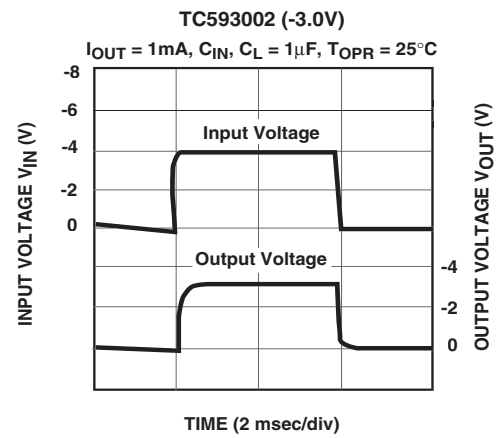
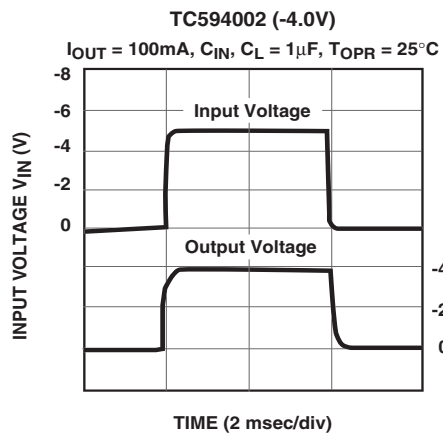

5.0 TYPICAL CHARACTERISTICS (CONTINUED)

8. LOAD TRANSIENT RESPONSE

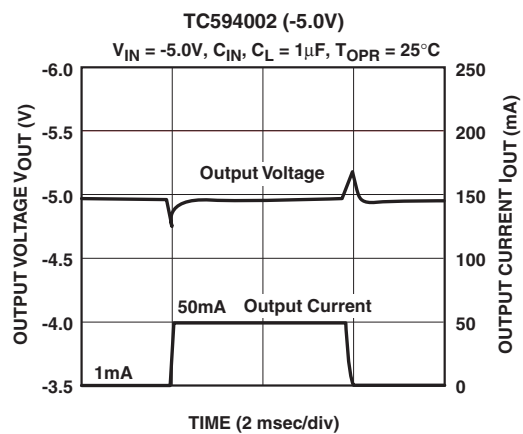
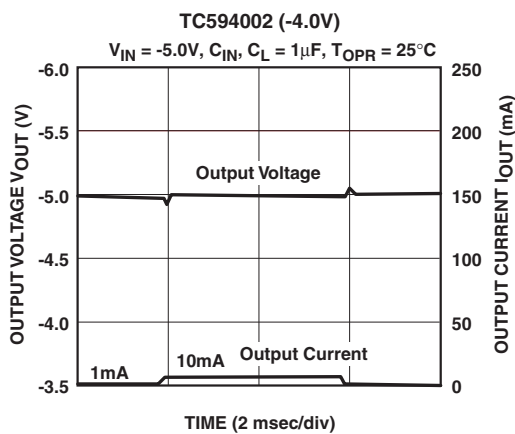
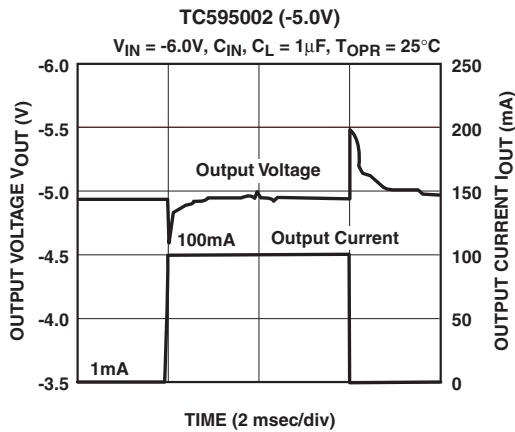
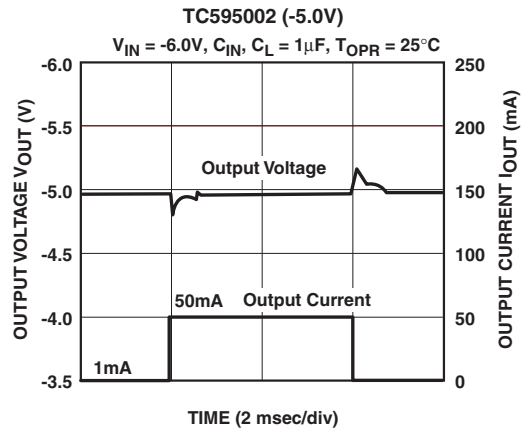
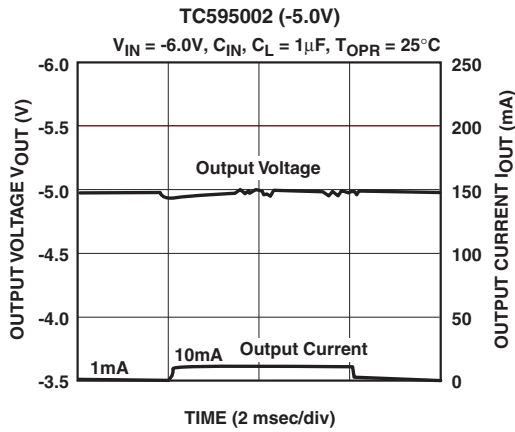

5.0 TYPICAL CHARACTERISTICS (CONTINUED)

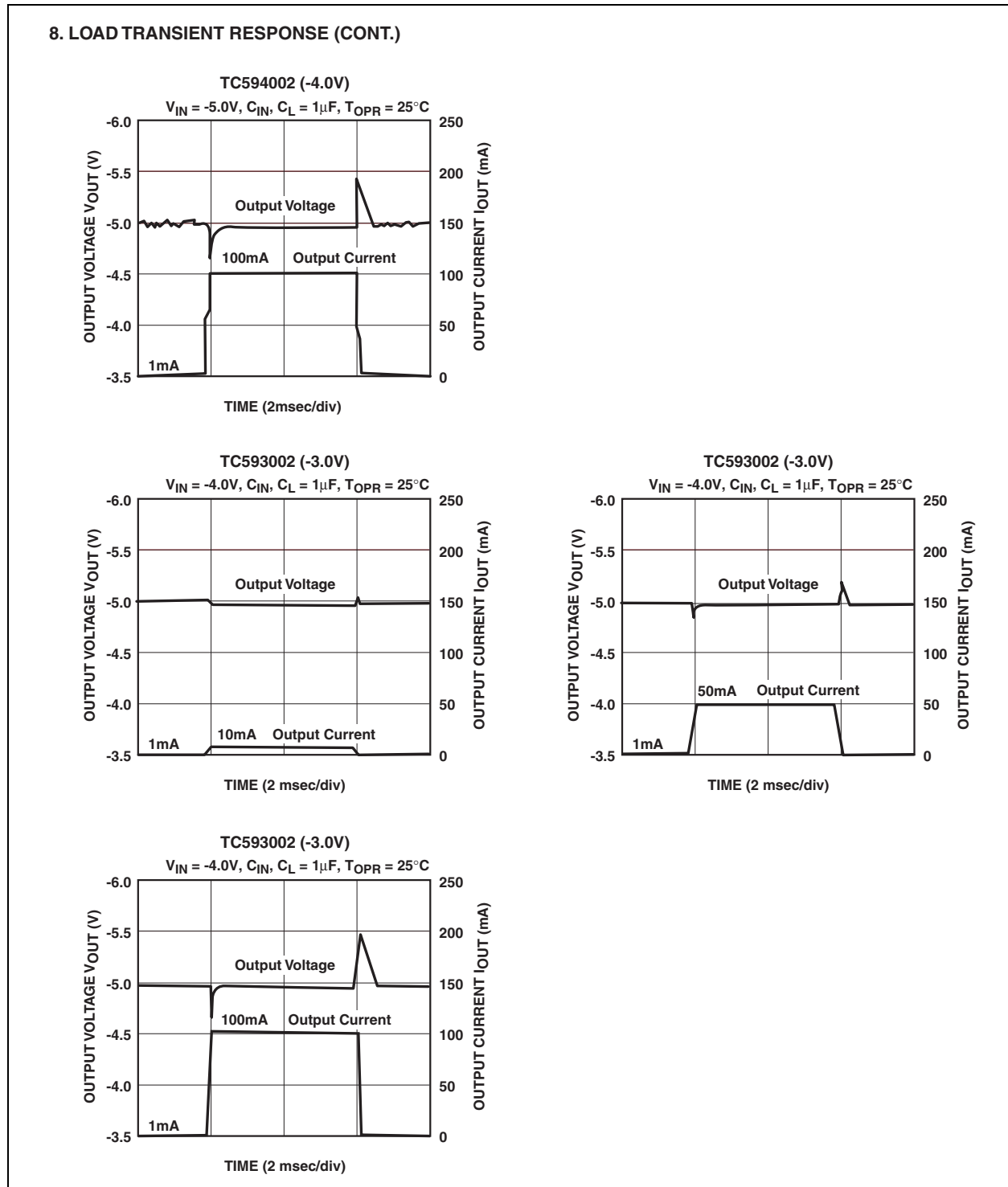

5.0 TYPICAL CHARACTERISTICS (CONTINUED)

9. RIPPLE REJECTION RATE

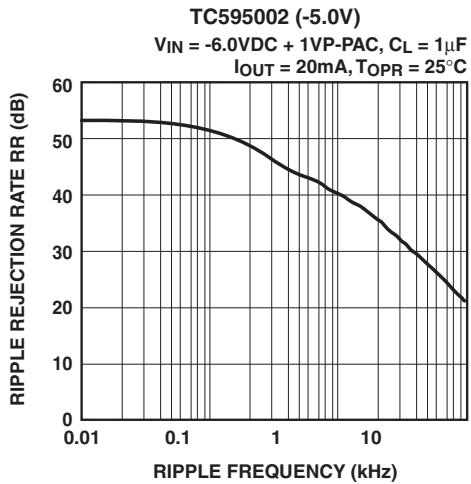
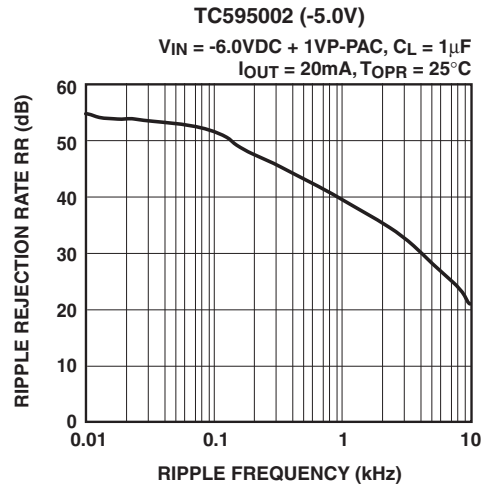
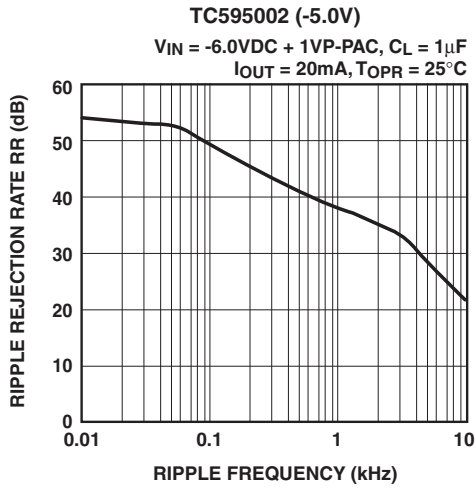

6.0 PACKAGING INFORMATION

6.1 Package Marking Information

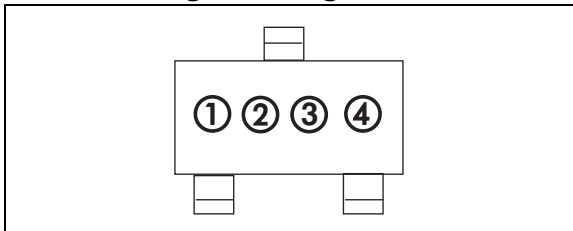

① represents first integer of output voltage

Symbol	Voltage
0	0.
1	1.
2	2.
3	3.
4	4.
5	5.
6	6.
7	7.
8	8.
9	9.

② represents first decimal of output voltage

Symbol	Voltage	Symbol	Voltage
A	.0	F	.5
B	.1	H	.6
C	.2	K	.7
D	.3	L	.8
E	.4	M	.9

③ represents voltage polarity

Symbol	Polarity
5	-

④ represents assembly lot code

6.2 Taping Form

Component Taping Orientation for 3-Pin SOT-23A (EIAJ SC-59) Devices

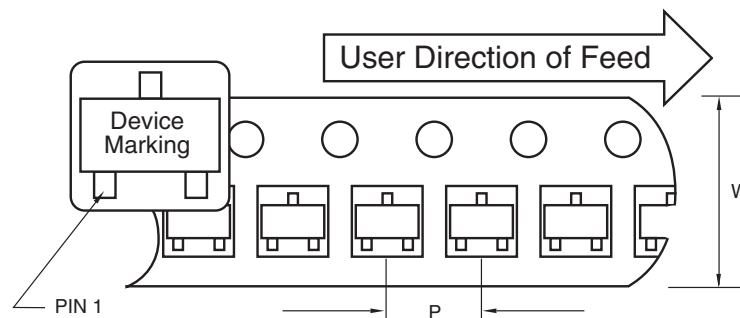

Standard Reel Component Orientation
for TR Suffix Device
(Mark Right Side Up)

Carrier Tape, Number of Components Per Reel and Reel Size

Package	Carrier Width (W)	Pitch (P)	Part Per Full Reel	Reel Size
3-Pin SOT-23A	8 mm	4 mm	3000	7 in

6.3 Package Dimensions

Note: For the most current package drawings, please see the Microchip Packaging Specification located at <http://www.microchip.com/packaging>

SOT-23A-3

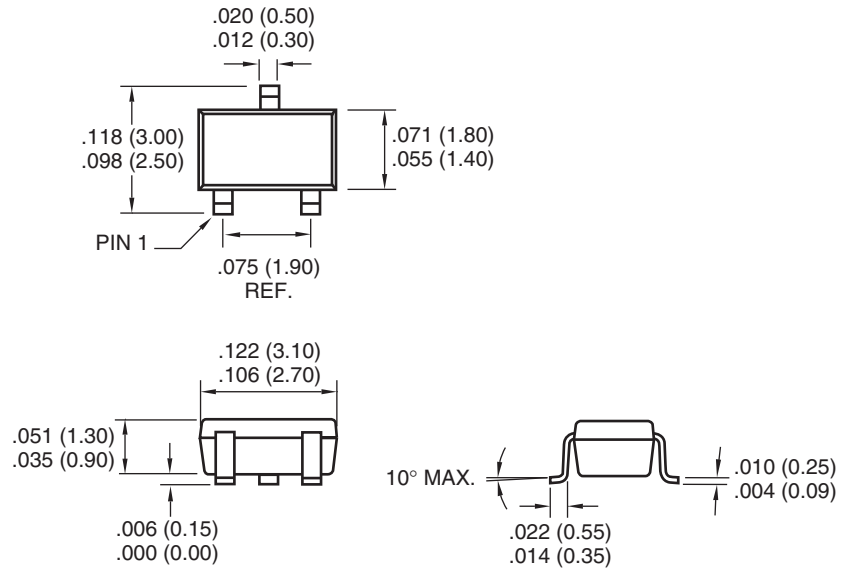

Dimensions: inches (mm)

7.0 REVISION HISTORY

Revision C (December 2012)

Added a note to the package outline drawing.

PRODUCT IDENTIFICATION SYSTEM

To order or obtain information, e.g., on pricing or delivery, refer to the factory or the listed sales office.

PART CODE	TC59	30	02	ECB	XX
	TC59	50	02	ECB	XX
Output Voltage:	_____		_____	_____	_____
	50 = -5.0V; 30 = -3.0V				
Tolerance:	_____		_____	_____	_____
	02 = 2%				
Temperature/Package:	_____		_____	_____	_____
	-40°C to +85°C				
	3-Pin SOT-23A				
Taping Direction:	_____		_____	_____	_____
	TR: Standard Taping				

Sales and Support

Data Sheets

Products supported by a preliminary Data Sheet may have an errata sheet describing minor operational differences and recommended workarounds. To determine if an errata sheet exists for a particular device, please contact one of the following:

1. Your local Microchip sales office
2. The Microchip Worldwide Site (www.microchip.com)

Please specify which device, revision of silicon and Data Sheet (include Literature #) you are using.

New Customer Notification System

Register on our web site (www.microchip.com/cn) to receive the most current information on our products.

TC59

NOTES:

Note the following details of the code protection feature on Microchip devices:

- Microchip products meet the specification contained in their particular Microchip Data Sheet.
- Microchip believes that its family of products is one of the most secure families of its kind on the market today, when used in the intended manner and under normal conditions.
- There are dishonest and possibly illegal methods used to breach the code protection feature. All of these methods, to our knowledge, require using the Microchip products in a manner outside the operating specifications contained in Microchip's Data Sheets. Most likely, the person doing so is engaged in theft of intellectual property.
- Microchip is willing to work with the customer who is concerned about the integrity of their code.
- Neither Microchip nor any other semiconductor manufacturer can guarantee the security of their code. Code protection does not mean that we are guaranteeing the product as “unbreakable.”

Code protection is constantly evolving. We at Microchip are committed to continuously improving the code protection features of our products. Attempts to break Microchip's code protection feature may be a violation of the Digital Millennium Copyright Act. If such acts allow unauthorized access to your software or other copyrighted work, you may have a right to sue for relief under that Act.

Information contained in this publication regarding device applications and the like is provided only for your convenience and may be superseded by updates. It is your responsibility to ensure that your application meets with your specifications. MICROCHIP MAKES NO REPRESENTATIONS OR WARRANTIES OF ANY KIND WHETHER EXPRESS OR IMPLIED, WRITTEN OR ORAL, STATUTORY OR OTHERWISE, RELATED TO THE INFORMATION, INCLUDING BUT NOT LIMITED TO ITS CONDITION, QUALITY, PERFORMANCE, MERCHANTABILITY OR FITNESS FOR PURPOSE. Microchip disclaims all liability arising from this information and its use. Use of Microchip devices in life support and/or safety applications is entirely at the buyer's risk, and the buyer agrees to defend, indemnify and hold harmless Microchip from any and all damages, claims, suits, or expenses resulting from such use. No licenses are conveyed, implicitly or otherwise, under any Microchip intellectual property rights.

Trademarks

The Microchip name and logo, the Microchip logo, dsPIC, FlashFlex, KEELOQ, KEELOQ logo, MPLAB, PIC, PICmicro, PICSTART, PIC³² logo, rPIC, SST, SST Logo, SuperFlash and UNI/O are registered trademarks of Microchip Technology Incorporated in the U.S.A. and other countries.

FilterLab, Hampshire, HI-TECH C, Linear Active Thermistor, MTP, SEEVAL and The Embedded Control Solutions Company are registered trademarks of Microchip Technology Incorporated in the U.S.A.

Silicon Storage Technology is a registered trademark of Microchip Technology Inc. in other countries.

Analog-for-the-Digital Age, Application Maestro, BodyCom, chipKIT, chipKIT logo, CodeGuard, dsPICDEM, dsPICDEM.net, dsPICworks, dsSPEAK, ECAN, ECONOMONITOR, FanSense, HI-TIDE, In-Circuit Serial Programming, ICSP, Mindi, MiWi, MPASM, MPF, MPLAB Certified logo, MPLIB, MPLINK, mTouch, Omniclient Code Generation, PICC, PICC-18, PICDEM, PICDEM.net, PICkit, PICtail, REAL ICE, rLAB, Select Mode, SQI, Serial Quad I/O, Total Endurance, TSHARC, UniWinDriver, WiperLock, ZENA and Z-Scale are trademarks of Microchip Technology Incorporated in the U.S.A. and other countries.

SQTP is a service mark of Microchip Technology Incorporated in the U.S.A.

GestIC and ULPP are registered trademarks of Microchip Technology Germany II GmbH & Co. & KG, a subsidiary of Microchip Technology Inc., in other countries.

All other trademarks mentioned herein are property of their respective companies.

© 2001-2012, Microchip Technology Incorporated, Printed in the U.S.A., All Rights Reserved.

 Printed on recycled paper.

ISBN: 9781620768228

QUALITY MANAGEMENT SYSTEM
CERTIFIED BY DNV
== ISO/TS 16949 ==

Microchip received ISO/TS-16949:2009 certification for its worldwide headquarters, design and wafer fabrication facilities in Chandler and Tempe, Arizona; Gresham, Oregon and design centers in California and India. The Company's quality system processes and procedures are for its PIC[®] MCUs and dsPIC[®] DSCs, KEELOQ[®] code hopping devices, Serial EEPROMs, microperipherals, nonvolatile memory and analog products. In addition, Microchip's quality system for the design and manufacture of development systems is ISO 9001:2000 certified.



MICROCHIP

Worldwide Sales and Service

AMERICAS

Corporate Office
2355 West Chandler Blvd.
Chandler, AZ 85224-6199
Tel: 480-792-7200
Fax: 480-792-7277
Technical Support:
<http://www.microchip.com/support>
Web Address:
www.microchip.com

Atlanta
Duluth, GA
Tel: 678-957-9614
Fax: 678-957-1455

Boston
Westborough, MA
Tel: 774-760-0087
Fax: 774-760-0088

Chicago
Itasca, IL
Tel: 630-285-0071
Fax: 630-285-0075

Cleveland
Independence, OH
Tel: 216-447-0464
Fax: 216-447-0643

Dallas
Addison, TX
Tel: 972-818-7423
Fax: 972-818-2924

Detroit
Farmington Hills, MI
Tel: 248-538-2250
Fax: 248-538-2260

Indianapolis
Noblesville, IN
Tel: 317-773-8323
Fax: 317-773-5453

Los Angeles
Mission Viejo, CA
Tel: 949-462-9523
Fax: 949-462-9608

Santa Clara
Santa Clara, CA
Tel: 408-961-6444
Fax: 408-961-6445

Toronto
Mississauga, Ontario,
Canada
Tel: 905-673-0699
Fax: 905-673-6509

ASIA/PACIFIC

Asia Pacific Office
Suites 3707-14, 37th Floor
Tower 6, The Gateway
Harbour City, Kowloon
Hong Kong
Tel: 852-2401-1200
Fax: 852-2401-3431

Australia - Sydney
Tel: 61-2-9868-6733
Fax: 61-2-9868-6755

China - Beijing
Tel: 86-10-8569-7000
Fax: 86-10-8528-2104

China - Chengdu
Tel: 86-28-8665-5511
Fax: 86-28-8665-7889

China - Chongqing
Tel: 86-23-8980-9588
Fax: 86-23-8980-9500

China - Hangzhou
Tel: 86-571-2819-3187
Fax: 86-571-2819-3189

China - Hong Kong SAR
Tel: 852-2943-5100
Fax: 852-2401-3431

China - Nanjing
Tel: 86-25-8473-2460
Fax: 86-25-8473-2470

China - Qingdao
Tel: 86-532-8502-7355
Fax: 86-532-8502-7205

China - Shanghai
Tel: 86-21-5407-5533
Fax: 86-21-5407-5066

China - Shenyang
Tel: 86-24-2334-2829
Fax: 86-24-2334-2393

China - Shenzhen
Tel: 86-755-8864-2200
Fax: 86-755-8203-1760

China - Wuhan
Tel: 86-27-5980-5300
Fax: 86-27-5980-5118

China - Xian
Tel: 86-29-8833-7252
Fax: 86-29-8833-7256

China - Xiamen
Tel: 86-592-2388138
Fax: 86-592-2388130

China - Zhuhai
Tel: 86-756-3210040
Fax: 86-756-3210049

ASIA/PACIFIC

India - Bangalore
Tel: 91-80-3090-4444
Fax: 91-80-3090-4123

India - New Delhi
Tel: 91-11-4160-8631
Fax: 91-11-4160-8632

India - Pune
Tel: 91-20-2566-1512
Fax: 91-20-2566-1513

Japan - Osaka
Tel: 81-6-6152-7160
Fax: 81-6-6152-9310

Japan - Tokyo
Tel: 81-3-6880-3770
Fax: 81-3-6880-3771

Korea - Daegu
Tel: 82-53-744-4301
Fax: 82-53-744-4302

Korea - Seoul
Tel: 82-2-554-7200
Fax: 82-2-558-5932 or
82-2-558-5934

Malaysia - Kuala Lumpur
Tel: 60-3-6201-9857
Fax: 60-3-6201-9859

Malaysia - Penang
Tel: 60-4-227-8870
Fax: 60-4-227-4068

Philippines - Manila
Tel: 63-2-634-9065
Fax: 63-2-634-9069

Singapore
Tel: 65-6334-8870
Fax: 65-6334-8850

Taiwan - Hsin Chu
Tel: 886-3-5778-366
Fax: 886-3-5770-955

Taiwan - Kaohsiung
Tel: 886-7-213-7828
Fax: 886-7-330-9305

Taiwan - Taipei
Tel: 886-2-2508-8600
Fax: 886-2-2508-0102

Thailand - Bangkok
Tel: 66-2-694-1351
Fax: 66-2-694-1350

EUROPE

Austria - Wels
Tel: 43-7242-2244-39
Fax: 43-7242-2244-393

Denmark - Copenhagen
Tel: 45-4450-2828
Fax: 45-4485-2829

France - Paris
Tel: 33-1-69-53-63-20
Fax: 33-1-69-30-90-79

Germany - Munich
Tel: 49-89-627-144-0
Fax: 49-89-627-144-44

Italy - Milan
Tel: 39-0331-742611
Fax: 39-0331-466781

Netherlands - Drunen
Tel: 31-416-690399
Fax: 31-416-690340

Spain - Madrid
Tel: 34-91-708-08-90
Fax: 34-91-708-08-91

UK - Wokingham
Tel: 44-118-921-5869
Fax: 44-118-921-5820

11/29/12