

### Package Contents

- Light Level Sensor
- 2 screws, 2 wall anchors
- Wire bracket

### Tools Required

- Power drill, 3/16" bit
- Screwdriver
- Light meter (for verification)

### Product Description

The ceiling-mounted Wireless Daylight Sensor is wireless, powered by natural light, and uses the solar cell to measure outside illumination to control open loop dimming systems.

Every minute the wireless daylight sensor measures the current light level via the solar cell.

If the change since last transmission is >50 lux it will immediately transmit an RF signal including the current measurement value. Otherwise there will be a heartbeat transmission after 20-30min.

In addition the device provides a light test mode which can be used to find a suitable position for installation.

### Features Include:

- Communicates wirelessly with other devices using the EnOcean wireless standard
- Harvests ambient solar energy to power the sensor and wireless communication
- Measures light level via the solar cell
- Mounts easily on any ceiling material
- Enables daylight harvesting in individual fixtures or zones controlled by TWR-D10 or other open loop dimming systems

### Specifications (typ. values)

Power Supply:	Solar energy harvesting
Measurement Range	0 – 1020 lux
Resolution	4 lux
Typical Accuracy	+/- 5% @ full scale, 68°F
Measurement Interval	1 minute
Transmission Interval	After measurement if change > 50 lux since last transmission Heartbeat every 20-30 minutes (affected at random)
Startup Charge Times* First motion transmission	(operation from empty energy storage) 5 minutes @ 200 lux
Sustaining Charge Time*	3 hours per 24 hours @ 200 lux
Time to Full Charge*	30 hours @ 200 lux
Operating Life in Total Darkness	80 hours (after full charge)
Configuration Interface	2 Buttons, 2 LED for device configuration & manual control
RF Communications	EnOcean 902 MHz
Transmission Range	80 ft. (25 m)
EnOcean Equipment Profile	A5-06-02
Dimensions	6.30" L x 2.36" W x 1.15" D (160mm x 60mm x 30mm)
Weight	4.4 oz. (125 g)
Mounting Position	At the ceiling, close to the ambient light source (window)
Environment	Indoor use only 32° to 140°F (0° to 60°C) 20% to 85% relative humidity (non-condensing)
Agency Compliance	FCC, IC, RoHS

\* Natural bright light (2000 lux) can be temporarily used to significantly shorten startup charge times. Specified lux values are for typical fluorescent lighting. Lux level requirements for LED and other types may vary. For lux reference, OSHA standards require a minimum of 323 lux for office areas.

## 1) Planning

Take a moment to plan for the sensor's successful operation and optimal communication with other system components.

Remove the sensor from its packaging and place it under a bright light to provide the required startup charge. Choose a proper installation location taking the following points into account.

- The sensor should be located at the ceiling, close to a window, or directly at the upper end of the interior window sidewall
- The chosen location should provide natural light only; the sensor solar cell should not measure artificial light
- The sensor should be mounted such that the solar cell points towards the window so that it measures the amount of incoming daylight light only.
- Use light test mode to see if the sensor properly measured daylight only. Light test mode blink rate should not change if artificial lights are switched on and off.
- In addition, during dusk or dawn use a light meter at the intended location to determine transition points. Switch lights on and off. Only small changes of the reported illumination should be seen.
- Consider the construction materials (such as metal) in the space and obstacles that may interfere with RF signals

## 2) Installing

estimated time: 20 minutes



The wireless daylight sensor can be mounted on most surfaces with the provided screws, or mounted on dropped ceilings, using the provided wire bracket.

**NOTE:** It is recommended to link the sensor before it is mounted on the ceiling. Refer to the "Linking" section.

1. Decide where you want to install the wireless daylight sensor.  
*Tip: The solar cell must point towards the window in order to measure outside illumination.*
2. Remove the mounting plate from the sensor.
3. Decide which of the two installation options is appropriate.

### A. Screw Mounting Plate to the Ceiling

- i. Hold the mounting plate in place and use a pencil to mark two small dots for the screw drill points.
- ii. Drill two holes with a 3/16" drill bit and insert the wall anchors.
- iii. Insert the first screw loosely and level the mounting plate.
- iv. Insert the second screw and then hand-tighten the first screw.

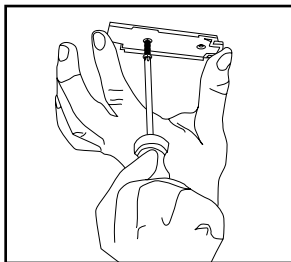

### B. Mount Using the Wire Bracket

- i. Remove the ceiling tile where you want to mount the sensor.
- ii. Place the mounting plate squarely on the ceiling tile and use the wire to mark two points for the holes.
- iii. Punch two small holes through the ceiling tile at the marked points.
- iv. Insert the wire bracket through the two holes in the mounting plate.

Make sure the ends are roughly even.

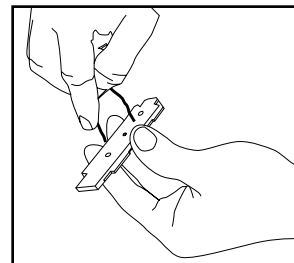

- v. Feed the wires through the holes in the ceiling tile.

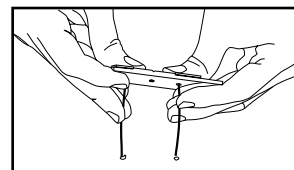

- vi. On the front of the ceiling tile, flatten the wire bracket so it is snug against the mounting plate.

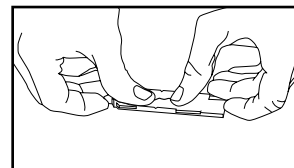

- vii. On the back of the ceiling tile, twist the wires together to hold the mounting plate securely.

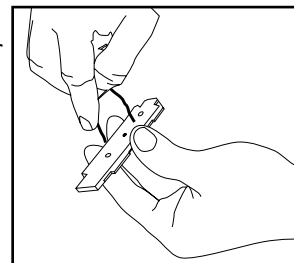

- viii. Replace the ceiling tile.

4. Attach the sensor to the mounting plate:  
With the 2-button interface facing you, slide the sensor to the left on the mounting plate until it snaps into place.

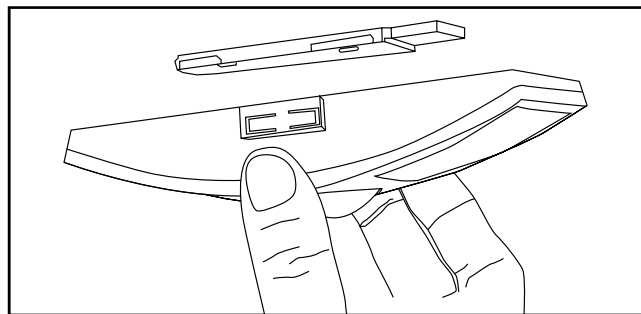

5. Confirm the sensor is properly positioned to measure outside illumination and has sufficient light to operate.

## 3) Linking

Linking is the process by which different devices are configured to work with each other in a system. Sometimes this process is also called Teach-in or Learn-in.

Specifically for the Wireless Daylight Sensor, linking is the process by which it identifies itself to another device that is capable of receiving processing its sensor data (e.g. an LED Controller, a Central Controller or a Gateway).

Note that the Wireless Daylight Sensor cannot be linked to devices such as sensors or switches that cannot receive or process its input data.

### Linking or Unlinking the Wireless Daylight Sensor

To link the Wireless Daylight Sensor with a suitable device, this device must be powered, within wireless range of the Wireless Daylight Sensor and set to linking or unlinking mode to receive specific link messages.

Once these conditions are met, the Wireless Daylight Sensor is triggered to send a link radio telegram.

The other device receives this link radio telegram and identifies the sensor ID and sensor type based on the information presented therein.

The other device then stores these parameters permanently so that it can automatically accept and process future telegrams originating from the Wireless Daylight Sensor.

This relationship between the Wireless Daylight Sensor and the device it is linked to can be terminated by unlinking the Wireless Daylight Sensor from the other device.

### Link or Unlink Procedure

1. Set the relay device to Link or Unlink mode (refer to that device's installation guide).
2. Shortly click the Menu (O) button on the side of the sensor once. This sends a link/unlink radio telegram.

*NOTE: The button interface on the sensor is used for linking and testing only.*

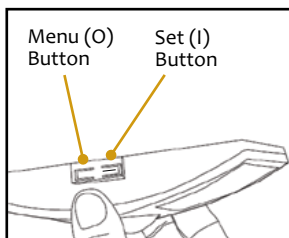

**Refer to the “Linking” section of the transceiver/controller installation guides to complete the linking & setup process.**

### Light Test

Before starting light test, ensure the sensor's energy storage is fully charged by placing it under bright light (2000 lux) for 1.5 hours.

Use the light test to measure real-time light levels and confirm whether the light level sensor has sufficient natural light, is not influenced by artificial lighting and whether the light level is within its measurement range.

1. Hold up or temporary mount the sensor to the intended mounting position.
2. Press and hold the Set (I) button for 5 seconds.
  - > Red & green LEDs will blink to confirm light test is active.
3. Watch the LED blink rate to determine the light strength.
  - > The highest is 5 blinks which indicates very good light (1000 lux or more). 0 blink indicates minimum light (<50 lux).
4. This test mode will be active for 3 minutes. It can be exit at any time by pressing the Menu (O) button.

## Troubleshooting

Problem	Solution Checklist
Sensor does not generate a wireless message	<ul style="list-style-type: none"> <li>▪ Press Set (I) button to transmit radio message</li> <li>▪ Verify the solar cell is charged properly</li> <li>▪ Check position using light test</li> </ul>
Linked device does not respond to wireless messages	<ul style="list-style-type: none"> <li>▪ Force radio message by pressing Set (I) button</li> <li>▪ Check for environment or range issues</li> <li>▪ Verify the device is linked</li> <li>▪ Check the transceiver connection and the wiring for errors</li> <li>▪ Check if appropriate devices are linked according to good system planning</li> </ul>



contains:  
FCC: SZV-PTM2104  
IC: 5713A-PTM2104

This device complies with part 15 of the FCC rules and Industry Canada ICES-003. Operation is subject to the following two conditions: (1) This device may not cause harmful interference, and (2) this device must accept any interference received, including interference that may cause undesired operation.

**IMPORTANT!** Any changes or modifications not expressly approved by the party responsible for compliance could void the user's authority to operate this equipment.

Le présent appareil est conforme aux CNR d'Industrie Canada applicables aux appareils radio exempts de licence. L'exploitation est autorisée aux deux conditions suivantes: (1) l'appareil ne doit pas produire de brouillage, et (2) l'utilisateur de l'appareil doit accepter tout brouillage radioélectrique subi, même si le brouillage est susceptible d'en compromettre le fonctionnement.

**IMPORTANT!** Tous les changements ou modifications pas expressément approuvés par la partie responsable de la conformité ont pu vider l'autorité de l'utilisateur pour actionner cet équipement.