

DUAL OPERATIONAL AMPLIFIER

■ GENERAL DESCRIPTION

The NJM4558 is a dual high-gain operational amplifier with internal compensation circuit and constructed on a single silicon chip. It offers excellent characteristics by combining the parameters adjusted for a monolithic chip. The channel separation characteristic is suitable for measuring instruments.

■ PACKAGE OUTLINE

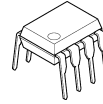

NJM4558D
(DIP8)



NJM4558M
(DMP8)



NJM4558V
(SSOP8)

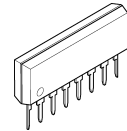

NJM4558L
(SIP8)



NJM4558E
(SOP8)

■ FEATURES

- Operating Voltage (±4V~±18V)
- High Voltage Gain (100dB typ.)
- High Input Resistance (5MΩ typ.)
- Bipolar Technology
- Package Outline DIP8, DMP8, SIP8
SOP8 JEDEC 150mil,
SSOP8

■ PIN CONFIGURATION

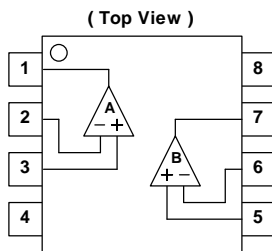

**NJM4558D, NJM4558M,
NJM4558E, NJM4558V**

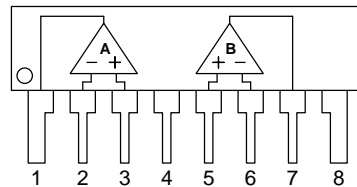

NJM4558L

PIN FUNCTION

1. A OUTPUT
2. A - INPUT
3. A + INPUT
4. V⁻
5. B + INPUT
6. B - INPUT
7. B OUTPUT
8. V⁺

■ EQUIVALENT CIRCUIT (1/2 Shown)

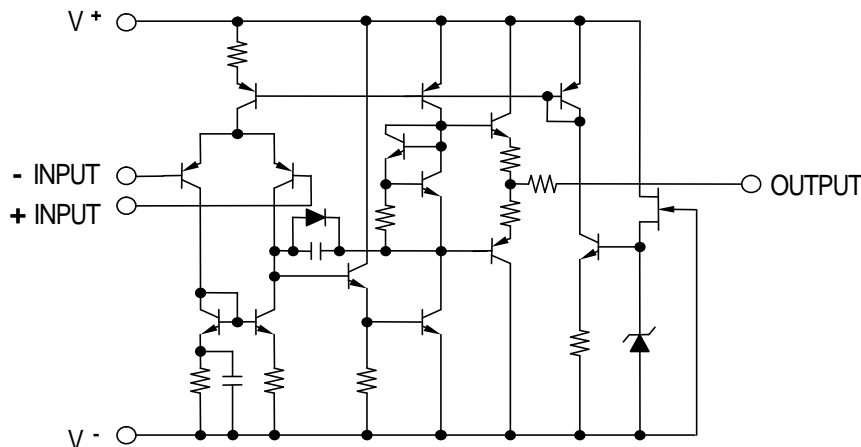

NJM4558

■ ABSOLUTE MAXIMUM RATINGS

(Ta=25°C)

| PARAMETER | SYMBOL | RATINGS | UNIT |
|-----------------------------|-----------|---|------|
| Supply Voltage | V^+V^- | ± 18 | V |
| Differential Input Voltage | V_{ID} | ± 30 | V |
| Input Voltage | V_{IC} | ± 15 (note1) | V |
| Power Dissipation | P_D | (DIP8) 500 (DMP8) 300 (SOP8) 300 (SSOP8) 250 (SIP8) 800 | mW |
| Operating Temperature Range | T_{opr} | -40~+85 | °C |
| Storage Temperature Range | T_{stg} | -40~+125 | °C |

(note1) For supply voltage less than ±15V, the absolute maximum input voltage is equal to the supply voltage.

■ ELECTRICAL CHARACTERISTICS

($V^+V^- = \pm 15V, T_a = 25^\circ C$)

| PARAMETER | SYMBOL | TEST CONDITION | MIN. | TYP. | MAX. | UNIT |
|--|-----------|-------------------------------------|------|------|------|-------|
| Input Offset Voltage | V_{IO} | $R_S \leq 10k\Omega$ | - | 0.5 | 6 | mV |
| Input Offset Current | I_{IO} | | - | 5 | 200 | nA |
| Input Bias Current | I_B | | - | 25 | 500 | nA |
| Input Resistance | R_{IN} | | 0.3 | 5 | - | MΩ |
| Large Signal Voltage Gain | A_V | $R_L \geq 2k\Omega, V_O = \pm 10V$ | 86 | 100 | - | dB |
| Maximum Output Voltage Swing 1 | V_{OM1} | $R_L \geq 10k\Omega$ | ± 12 | ± 14 | - | V |
| Maximum Output Voltage Swing 2 | V_{OM2} | $R_L \geq 2k\Omega$ | ± 10 | ± 13 | - | V |
| Input Common Mode Voltage Range | V_{ICM} | | ± 12 | 14 | - | V |
| Common Mode Rejection Ratio | CMR | $R_S \leq 10k\Omega$ | 70 | 90 | - | dB |
| Supply Voltage Rejection Ratio | SVR | $R_S \leq 10k\Omega$ | 76.5 | 90 | - | dB |
| Operating Current | I_{CC} | | - | 3.5 | 5.7 | mA |
| Slew Rate | SR | | - | 1 | - | V/μs |
| Equivalent Input Noise Voltage (note2) | V_{NI} | RIAA, $R_S = 2.2k\Omega, 30kHz$ LPF | - | 1.4 | - | μVrms |
| Gain Bandwidth Product | GB | | - | 3 | - | MHz |

(note2) In regard to Noise Standard, NJRC is preparing for special D Rank type products ($V_{NI} = 1.8\mu V$ max.) except for SSOP package.

TYPICAL CHARACTERISTICS

Open Loop Voltage Gain vs. Frequency
 $V^+/V^- = \pm 15V, R_L = 2k\Omega, T_a = 25^\circ C$

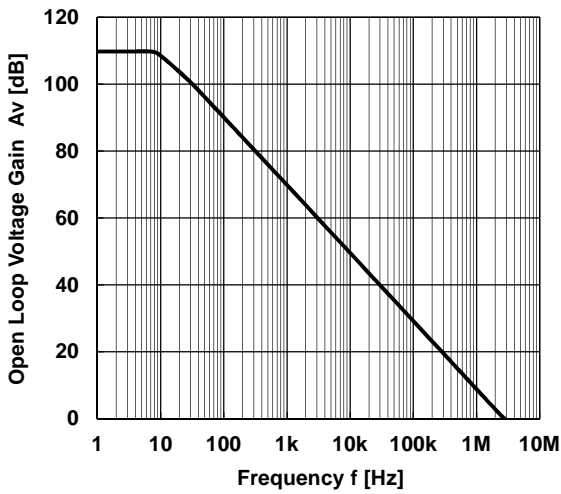

Maximum Output Voltage Swing vs. Frequency
 $V^+/V^- = \pm 15V, R_L = 2k\Omega, T_a = 25^\circ C$

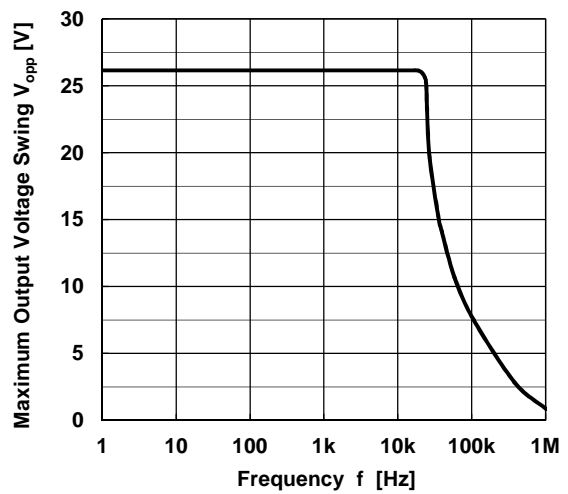

Maximum Output Voltage Swing vs. Load Resistance
 $V^+/V^- = \pm 15V, T_a = 25^\circ C$

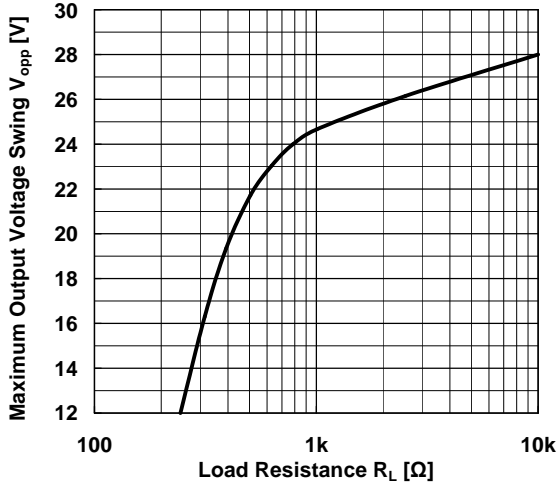

Equivalent Input Noise Voltage vs. Frequency
 $V^+/V^- = \pm 15V, R_s = 50\Omega, A_v = 60dB, T_a = 25^\circ C$

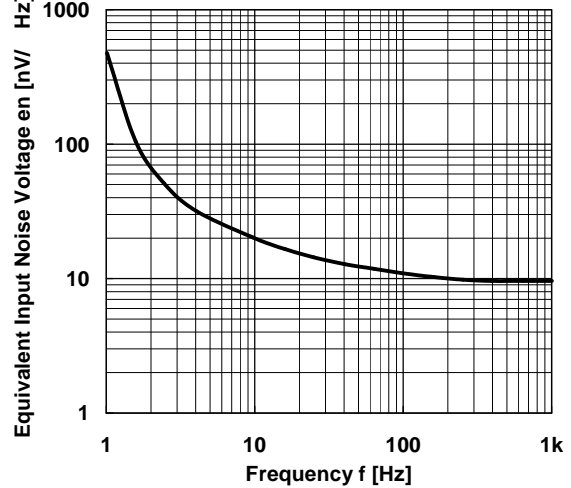

Operating Current vs. Temperature
 $V^+/V^- = \pm 15V$

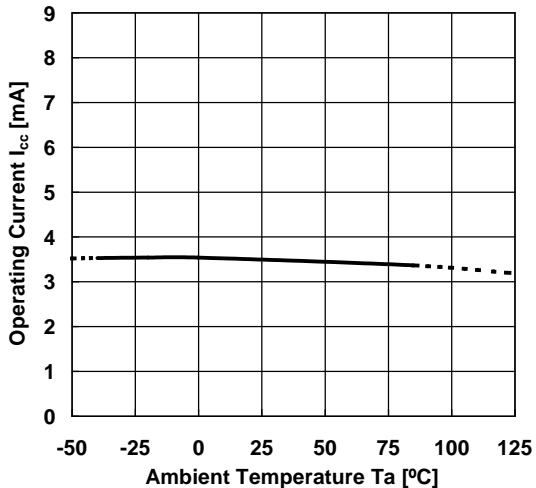

Maximum Output Voltage Swing vs. Temperature
 $V^+/V^- = \pm 15V, R_L = 10k\Omega$

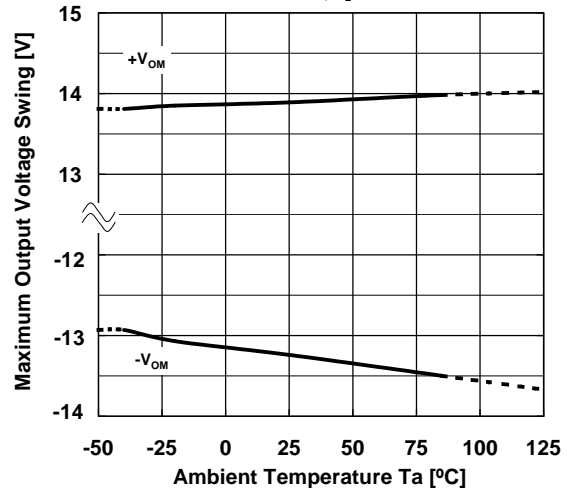

■ TYPICAL CHARACTERISTICS

Input Offset Voltage vs. temperature
 $V^+/V^- = \pm 15V$

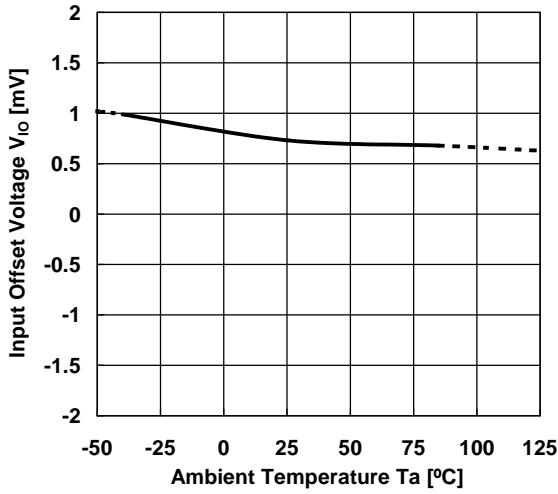

Input Bias Current vs. Temperature
 $V^+/V^- = \pm 15V$

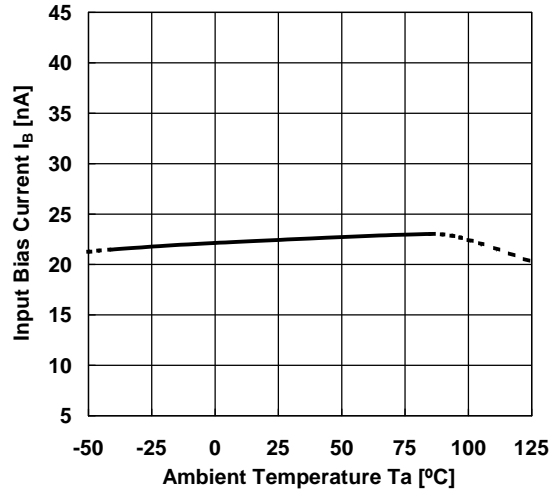

Maximum Output Voltage Swing vs. Operating Voltage
 $R_L = 2k\Omega, T_a = 25^\circ C$

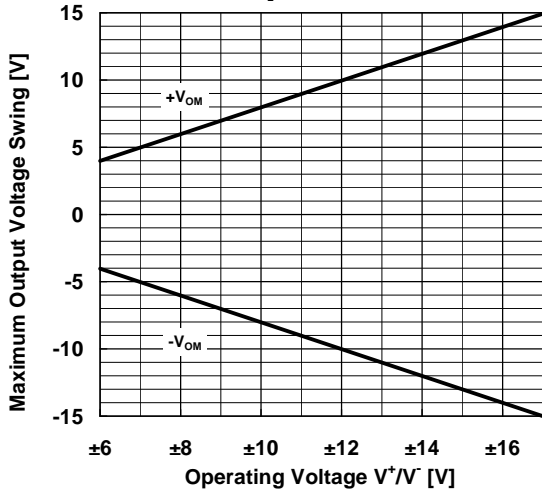

Operating Current vs. Operating Voltage
 $T_a = 25^\circ C$

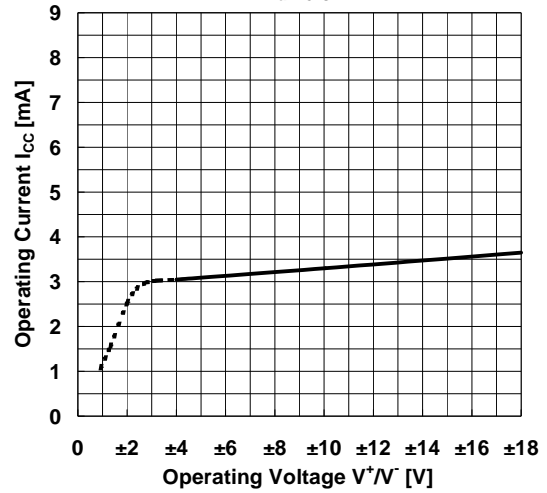

[CAUTION]

The specifications on this databook are only given for information, without any guarantee as regards either mistakes or omissions. The application circuits in this databook are described only to show representative usages of the product and not intended for the guarantee or permission of any right including the industrial rights.