

SF2038B-3

76.500 MHz SAW Filter

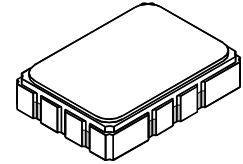

SMP-03-S

- **Designed for SDARS IF Receiver**
- **Low Insertion Loss**
- **5.0 X 7.0 mm Surface-Mount Case**
- **Differential or Single Ended Input and Output**
- **Complies with Directive 2002/95/EC (RoHS)**
- **Tape and Reel Standard per ANSI/EIA-481**
- **Moisture Sensitivity Level: 1**
- **AEC-Q200 Qualified**

Absolute Maximum Ratings

Rating	Value	Units
Maximum Incident Power in Passband	+10	dBm
Max. DC voltage between any 2 terminals	30	VDC
Storage Temperature Range	-40 to +85	°C
Max Soldering Profile	265°C for 10 s	

Electrical Characteristics

Characteristic	Sym	Notes	Min	Typ	Max	Units
Nominal Center Frequency	f_c			76.500		MHz
Passband	Insertion Loss	IL		10.0	12.0	dB
	1dB Passband	BW_1	12.5	14.0		MHz
	15dB Bandwidth	BW_{15}		16.8	18.0	MHz
	30dB Bandwidth	BW_{30}		18.0	19.2	MHz
	Amplitude Ripple over $f_c \pm 6.25$ MHz			0.70	1.3	dB _{P-P}
Group Delay Variation over $f_c \pm 6.25$ MHz	GDV			40	150	ns _{P-P}
Rejection	50 to 64.44 MHz		40	46		dB
	64.44 to 66.70 MHz		36	41		
	86.30 to 87.54 MHz		30	44		
	87.54 to 91.50 MHz		31	44		
	91.50 to 100 MHz		40	47		
Operating Temperature Range	T_A		-40		+85	°C
Frequency Coefficient	FTC			-87		ppm/°C
Differential Input			175 ohms			
Differential Output			180 ohms			
Case Style			SMP-03-S 7 x 5 mm Nominal Footprint			
Lid Symbolization (YY=year, WW=week, S=shift, ## = Sequence Code)			RFM, SF2038B-3, YYWWS##			

Electrical Connections

Connection	Port 1 Hot	Port 1 Ground Return or Hot	Port 2 Hot	Port 2 Ground Return or Hot	Case Ground
Terminals	10	1	5	6	All Others



CAUTION: Electrostatic Sensitive Device. Observe precautions for handling.

NOTES:

1. The design, manufacturing process, and specifications of this device are subject to change.
2. US or International patents may apply.
3. RoHS compliant from the first date of manufacture.

SMP-03-S Case

12-Terminal Ceramic Surface-Mount Case 5 x 7 mm Nominal Footprint

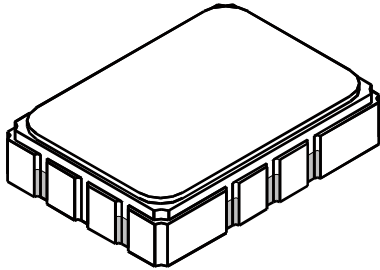

Case Dimensions						
Dimension	mm			Inches		
	Min	Nom	Max	Min	Nom	Max
A	6.80	7.00	7.20	0.268	0.276	0.283
B	4.80	5.00	5.20	0.189	0.197	0.205
C		1.65	2.00		0.065	0.079
D		0.80				
E	2.41	2.54	2.67	0.095	0.100	0.105
H	0.87	1.1	1.13	0.034	0.039	0.044
J		2.54				
K	2.87	3.00	3.13	0.113	0.118	0.123
P	1.14	1.27	1.40	0.045	0.050	0.055

Materials	
Solder Pad Termination	Au plating 30 - 60 pinches (76.2-152 μm) over 80-200 pinches (203-508 μm) Ni.
Lid	Fe-Ni-Co Alloy Electroless Nickel Plate (8-11% Phosphorus) 100-200 pinches Thick
Body	Al_2O_3 Ceramic

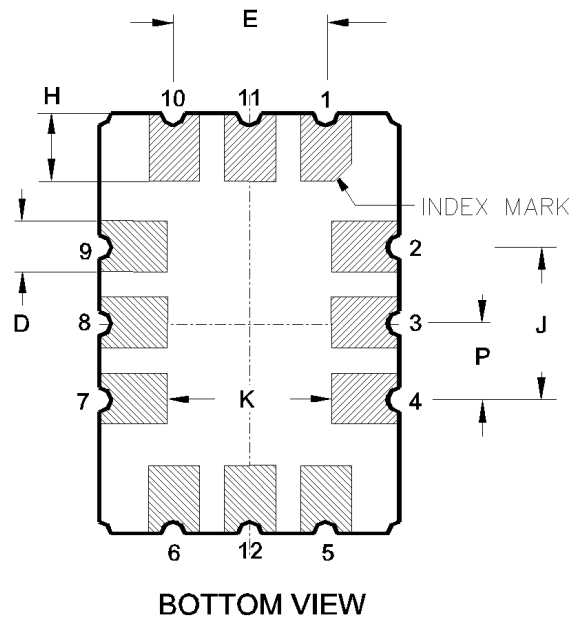
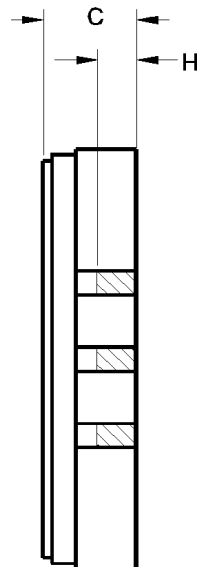
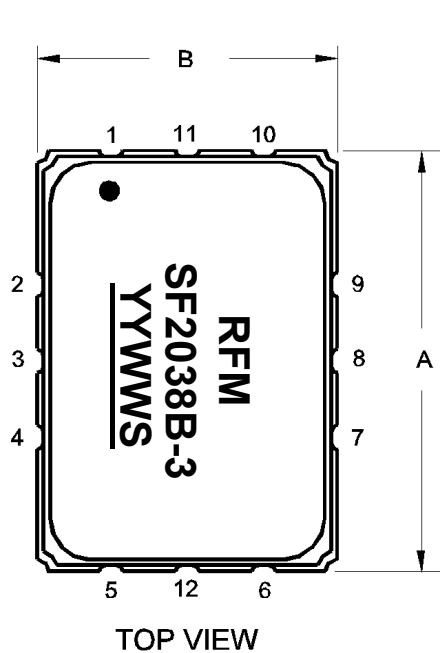

COMPONENT ORIENTATION and DIMENSIONS

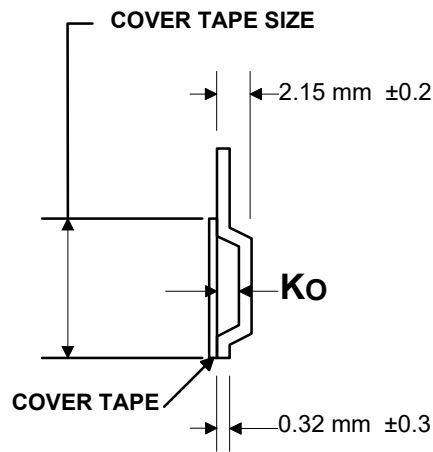
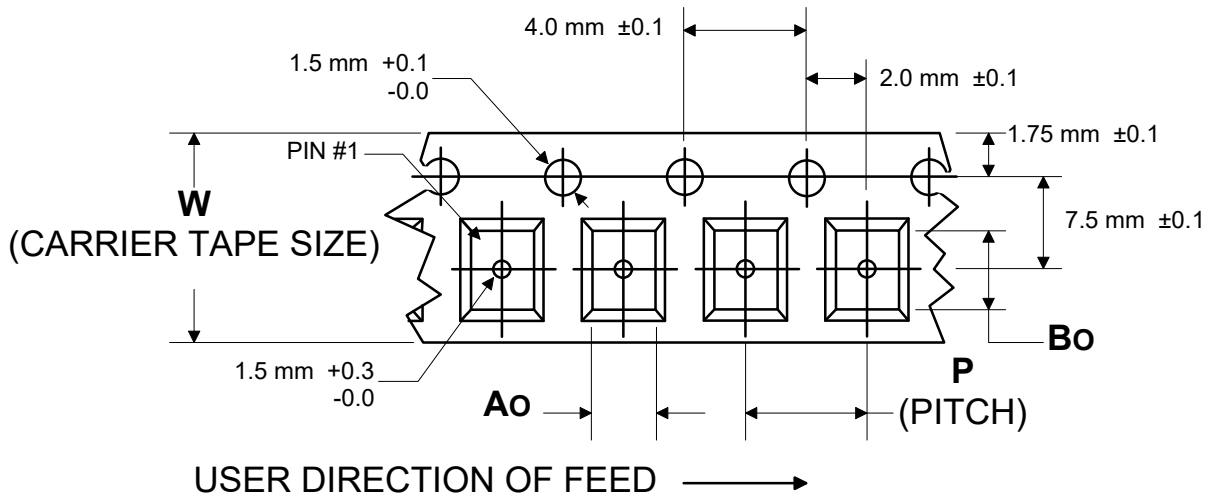

Carrier Tape Dimensions		
Ao	5.5 mm	±0.1
Bo	7.5 mm	±0.1
Ko	2.0 mm	±0.1
Pitch	8.0 mm	±0.1
W	16.0 mm	±0.3

Recommended Reflow Profile

1. Preheating shall be fixed at 150~180°C for 60~90 seconds.
2. Ascending time to preheating temperature 150°C shall be 30 seconds min.
3. Heating shall be fixed at 220°C for 50~80 seconds and at 260°C+0/-5°C peak (10 seconds).
4. Time: 5 times maximum.

