

### **Rochester Electronics Manufactured Components**

Rochester branded components are manufactured using either die/wafers purchased from the original suppliers or Rochester wafers recreated from the original IP. All recreations are done with the approval of the OCM.

Parts are tested using original factory test programs or Rochester developed test solutions to guarantee product meets or exceed the OCM data sheet.

### **Quality Overview**

- ISO-9001
- AS9120 certification
- Qualified Manufacturers List (QML) MIL-PRF-35835
  - Class Q Military
  - Class V Space Level
- Qualified Suppliers List of Distributors (QSLD)
  - Rochester is a critical supplier to DLA and meets all industry and DLA standards.

Rochester Electronics, LLC is committed to supplying products that satisfy customer expectations for quality and are equal to those originally supplied by industry manufacturers.

The original manufacturer's datasheet accompanying this document reflects the performance and specifications of the Rochester manufactured version of this device. Rochester Electronics guarantees the performance of its semiconductor products to the original OEM specifications. 'Typical' values are for reference purposes only. Certain minimum or maximum ratings may be based on product characterization, design, simulation, or sample testing.

# SN54122, SN54123, SN54130, SN54L122, SN54L123, SN54LS122, SN54LS123, SN74122, SN74123, SN74130, SN74LS122, SN74LS123 RETRIGGERABLE MONOSTABLE MULTIVIBRATORS

REVISED OCTOBER 1983

- D-C Triggered from Active High or Active -Low Gated Logic Inputs
- Retriggerable for Very Long Output Pulses, Up to 100% Duty Cycle
- Overriding Clear Terminates Output Pulse
- '122, 'L122, 'LS122 Have Internal Timing Resistors

## description

These d-c triggered multivibrators feature output pulse width control by three methods. The basic pulse time is programmed by selection of external resistance and capacitance values (see typical application data). The '122, 'L122, and 'LS122 have internal timing resistors that allow the circuits to be used with only an external capacitor, if so desired. Once triggered, the basic pulse width may be extended by retriggering the gated low-level-active (A) or high-level-active (B) inputs, or it is reduced by use of the overriding clear. Figure 1 illustrates pulse control by retriggering and early clear.

The 'LS122 and 'LS123 are provided enough Schmitt hysteresis to ensure jitter-free triggering from the B input with transition rates as slow as 0.1 millivolt per nanosecond.

The  $R_{int}$  is nominally 10 k ohms for '122, 'LS122, and 'LS123, and is nominally 20 k ohms for 'L122.

SN54122 ... JK PACKAGE  
SN54L122 ... JK PACKAGE  
SN74122 ... JK PACKAGE  
SN74LS122 ... JK PACKAGE  
(TOP VIEW) (SEE NOTES 1 THRU 4)

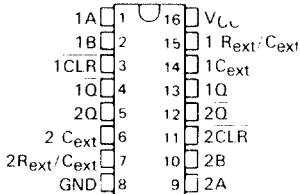

- NOTES: 1. An external timing capacitor may be connected between  $C_{ext}$  and  $R_{ext}/C_{ext}$  (positive).  
2. To use the internal timing resistor of '122, 'L122, or 'LS122, connect  $R_{int}$  to  $V_{CC}$ .  
3. For improved pulse width accuracy and repeatability, connect an external resistor between  $R_{ext}/C_{ext}$  and  $V_{CC}$  with  $R_{int}$  open-circuited.  
4. To obtain variable pulse widths, connect an external variable resistance between  $R_{int}$  or  $R_{ext}/C_{ext}$  and  $V_{CC}$ .

SN54123 ... JK PACKAGE  
SN54L123 ... JK PACKAGE  
SN74123 ... JK PACKAGE  
SN74LS123 ... JK PACKAGE  
(TOP VIEW) (SEE NOTES 1 THRU 4)

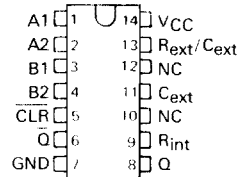

SN54LS122 ... FK PACKAGE  
SN74LS122 ... FN PACKAGE  
(TOP VIEW) (SEE NOTES 1 THRU 4)

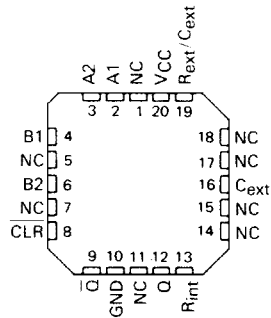

SN54LS123 ... FK PACKAGE  
SN74LS123 ... FN PACKAGE  
(TOP VIEW) (SEE NOTES 1 THRU 4)

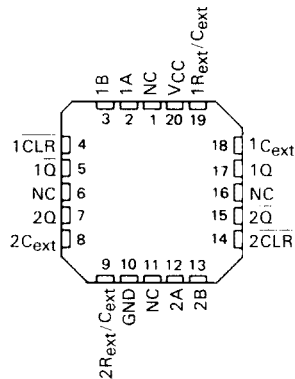

NC - No internal connection

## PRODUCTION DATA

This document contains information current as of publication date. Products conform to specifications per the terms of Texas Instruments standard warranty. Production processing does not necessarily include testing of all parameters.

TEXAS  
INSTRUMENTS

POST OFFICE BOX 225012 • DALLAS, TEXAS 75265

3-477

SN54122, SN54123, SN54130, SN54L122, SN54L123, SN54LS122, SN54LS123,  
 SN74122, SN74123, SN74130, SN74LS122, SN74LS123  
 RETRIGGERABLE MONOSTABLE MULTIVIBRATORS

description (continued)

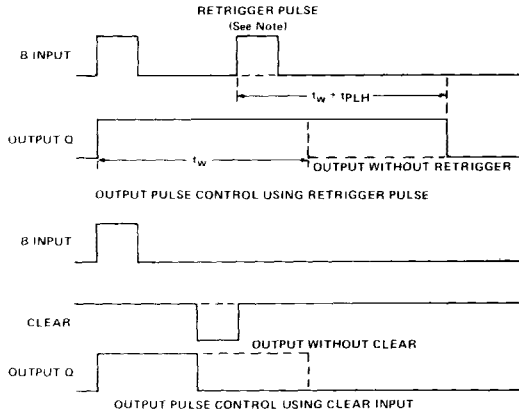

NOTE: Retrigger pulses starting before  $0.22 C_{ext}$  (in picofrads) nanoseconds after the initial trigger pulse will be ignored and the output pulse will remain unchanged.

FIGURE 1—TYPICAL INPUT/OUTPUT PULSES

'122, 'L122, 'LS122  
 FUNCTION TABLE

| CLEAR | INPUTS |    |    |    | OUTPUTS   |           |
|-------|--------|----|----|----|-----------|-----------|
|       | A1     | A2 | B1 | B2 | Q         | $\bar{Q}$ |
| L     | X      | X  | X  | X  | L         | H         |
| X     | H      | H  | X  | X  | L†        | H†        |
| X     | X      | X  | L  | X  | L†        | H†        |
| X     | X      | X  | X  | L  | L†        | H†        |
| H     | L      | X  | †  | H  | $\bar{U}$ | $\bar{U}$ |
| H     | L      | X  | H  | †  | $\bar{U}$ | $\bar{U}$ |
| H     | X      | L  | †  | H  | $\bar{U}$ | $\bar{U}$ |
| H     | X      | L  | H  | †  | $\bar{U}$ | $\bar{U}$ |
| H     | H      | †  | H  | H  | $\bar{U}$ | $\bar{U}$ |
| H     | †      | †  | H  | H  | $\bar{U}$ | $\bar{U}$ |
| H     | †      | H  | H  | H  | $\bar{U}$ | $\bar{U}$ |
| †     | †      | X  | H  | H  | $\bar{U}$ | $\bar{U}$ |
| †     | X      | L  | H  | H  | $\bar{U}$ | $\bar{U}$ |

'123, '130, 'L123, 'LS123  
 FUNCTION TABLE

| CLEAR | INPUTS |   | OUTPUTS   |           |
|-------|--------|---|-----------|-----------|
|       | A      | B | Q         | $\bar{Q}$ |
| L     | X      | X | L         | H         |
| X     | H      | X | L†        | H†        |
| X     | X      | L | L†        | H†        |
| H     | L      | † | $\bar{U}$ | $\bar{U}$ |
| H     | †      | H | $\bar{U}$ | $\bar{U}$ |
| †     | L      | H | $\bar{U}$ | $\bar{U}$ |

See explanation of function tables on page

† These lines of the functional tables assume that the indicated steady-state conditions at the A and B inputs have been set up long enough to complete any pulse started before the set up.

3

TTL DEVICES

**SN54122, SN54123, SN54130, SN54L122, SN54L123, SN54LS122, SN54LS123,  
SN74122, SN74123, SN74130, SN74LS122, SN74LS123  
RETRIGGERABLE MONOSTABLE MULTIVIBRATORS**

logic diagram

logic symbol

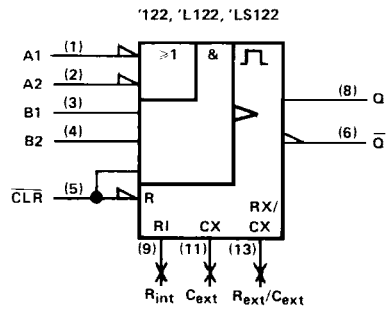
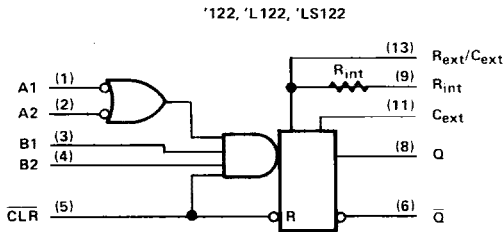

$R_{int}$  is nominally 10 k ohms for '122, 'LS122, and 20 k ohms for 'L122.

logic diagram (each multivibrator)

logic symbol

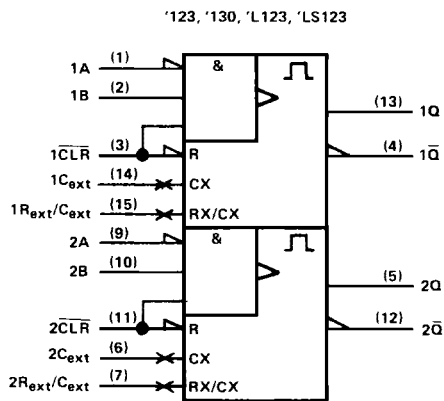
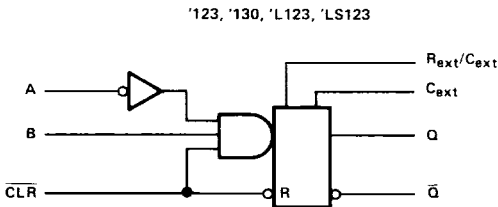

Pin numbers shown on logic notation are for D, J or N packages.

**SN54122, SN54123, SN54130, SN54L122, SN54L123, SN54LS122, SN54LS123,  
SN74122, SN74123, SN74130, SN74LS122, SN74LS123  
RETRIGGERABLE MONOSTABLE MULTIVIBRATORS**

schematics of inputs and outputs

'122, '123, '130, 'L122, 'L123 CIRCUITS

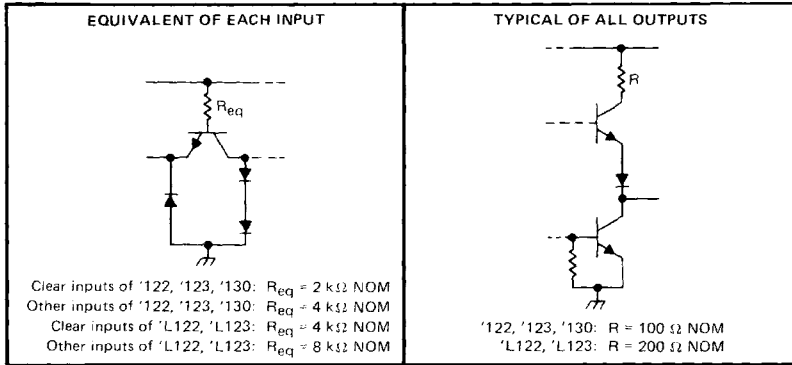

'LS122, 'LS123 CIRCUITS

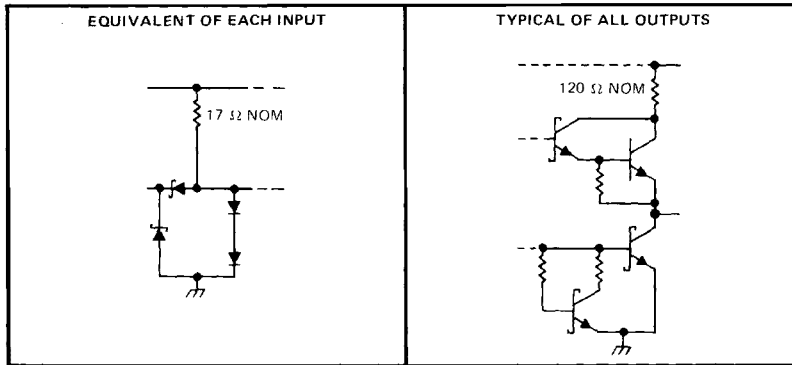

# TYPES SN54122, SN54123, SN54130, SN74122, SN74123, SN74130 RETRIGGERABLE MONOSTABLE MULTIVIBRATORS

## recommended operating conditions

|   | SN54 <sup>1</sup> |     |     | SN74 <sup>1</sup> |     |      | UNIT  |       |
|---|-------------------|-----|-----|-------------------|-----|------|-------|-------|
|   | MIN               | NOM | MAX | MIN               | NOM | MAX  |       |       |
| Supply voltage, V <sub>CC</sub>                                   | 4.5               | 5   | 5.5 | 4.75              | 5   | 5.25 | V     |       |
| High-level output current, I <sub>OH</sub>                        | -800              |     |     | -800              |     |      | μA    |       |
| Low-level output current, I <sub>OL</sub>                         | 16                |     |     | 16                |     |      | mA    |       |
| Pulse width, t <sub>w</sub>                                       | 40                |     |     | 40                |     |      | ns    |       |
| External timing resistance, R <sub>ext</sub>                      | 5                 |     |     | 5                 |     |      | 50 kΩ |       |
| External capacitance, C <sub>ext</sub>                            | No restriction    |     |     | No restriction    |     |      |       |       |
| Wiring capacitance at R <sub>ext</sub> /C <sub>ext</sub> terminal | 50                |     |     | 50                |     |      | pF    |       |
| Operating free-air temperature, T <sub>A</sub>                    | -55               |     |     | 125               |     |      | 0     | 70 °C |

## electrical characteristics over recommended free-air operating temperature range (unless otherwise noted)

| PARAMETER   | TEST CONDITIONS <sup>†</sup>                                 | '122 |                  |     | '123, '130 |                  |     | UNIT |
|---|--|------|------------------|-----|------------|------------------|-----|------|
|   |  | MIN  | TYP <sup>‡</sup> | MAX | MIN        | TYP <sup>‡</sup> | MAX |      |
| V <sub>IH</sub> High-level input voltage                  |  | 2    |                  |     | 2          |                  |     | V    |
| V <sub>IL</sub> Low-level input voltage                   |  | 0.8  |                  |     | 0.8        |                  |     | V    |
| V <sub>IK</sub> Input clamp voltage                       | V <sub>CC</sub> = MIN, I <sub>I</sub> = -12 mA               | -1.5 |                  |     | -1.5       |                  |     | V    |
| V <sub>OH</sub> High-level output voltage                 | V <sub>CC</sub> = MIN, I <sub>OH</sub> = -800 μA, See Note 1 | 2.4  | 3.4              |     | 2.4        | 3.4              |     | V    |
| V <sub>OL</sub> Low-level output voltage                  | V <sub>CC</sub> = MIN, I <sub>OL</sub> = 16 mA, See Note 1   | 0.2  |                  | 0.4 | 0.2        |                  | 0.4 | V    |
| I <sub>I</sub> Input current at maximum input voltage     | V <sub>CC</sub> = MAX, V <sub>I</sub> = 5.5 V                | 1    |                  |     | 1          |                  |     | mA   |
| I <sub>IH</sub> High-level input current                  | Data inputs  | 40   |                  |     | 40         |                  |     | μA   |
|   | Clear input  | 80   |                  |     | 80         |                  |     |      |
| I <sub>IL</sub> Low-level input current                   | Data inputs  | -1.6 |                  |     | -1.6       |                  |     | mA   |
|   | Clear input  | -3.2 |                  |     | -3.2       |                  |     |      |
| I <sub>OS</sub> Short-circuit output current <sup>¶</sup> | V <sub>CC</sub> = MAX, See Note 5                            | -10  | -40              |     | -10        | -40              |     | mA   |
| I <sub>CC</sub> Supply current (quiescent or triggered)   | V <sub>CC</sub> = MAX, See Notes 6 and 7                     | 23   |                  | 36  | 46         |                  | 66  | mA   |

<sup>†</sup> For conditions shown as MIN or MAX, use the value specified under recommended operating conditions.

<sup>‡</sup> All typical values are at V<sub>CC</sub> = 5 V, T<sub>A</sub> = 25°C.

<sup>¶</sup> Not more than one output should be shorted at a time.

- NOTES: 5. Ground C<sub>ext</sub> to measure V<sub>OH</sub> at Q, V<sub>OL</sub> at  $\bar{Q}$ , or I<sub>OS</sub> at Q. C<sub>ext</sub> is open to measure V<sub>OH</sub> at  $\bar{Q}$ , V<sub>OL</sub> at Q, or I<sub>OS</sub> at  $\bar{Q}$ .  
 6. Quiescent I<sub>CC</sub> is measured (after clearing) with 2.4 V applied to all clear and A inputs, B inputs grounded, all outputs open, C<sub>ext</sub> = 0.02 μF, and R<sub>ext</sub> = 25 kΩ. R<sub>int</sub> of '122 is open.  
 7. I<sub>CC</sub> is measured in the triggered state with 2.4 V applied to all clear and B inputs, A inputs grounded, all outputs open, C<sub>ext</sub> = 0.02 μF, and R<sub>ext</sub> = 25 kΩ. R<sub>int</sub> of '122 is open.

## switching characteristics, V<sub>CC</sub> = 5 V, T<sub>A</sub> = 25°C, see note 8

| PARAMETER <sup>¶</sup> | FROM (INPUT) | TO (OUTPUT) | TEST CONDITIONS   | '122, '130 |      |      | '123 |      |      | UNIT |
|------------------------|--------------|-------------|---|------------|------|------|------|------|------|------|
|                        |              |             |   | MIN        | TYP  | MAX  | MIN  | TYP  | MAX  |      |
| t <sub>PLH</sub>       | A            | Q           | C <sub>ext</sub> = 0, R <sub>ext</sub> = 5 kΩ, C <sub>L</sub> = 15 pF, R <sub>L</sub> = 400 Ω | 22         | 33   |      | 22   | 33   |      | ns   |
|                        | B            |             |   | 19         | 28   |      | 19   | 28   |      |      |
| t <sub>PHL</sub>       | A            | $\bar{Q}$   |   | 30         | 40   |      | 30   | 40   |      | ns   |
|                        | B            |             |   | 27         | 36   |      | 27   | 36   |      |      |
| t <sub>PHL</sub>       | Clear        | Q           |   | 18         | 27   |      | 18   | 27   |      | ns   |
| t <sub>PLH</sub>       |              | $\bar{Q}$   |   | 30         | 40   |      | 30   | 40   |      |      |
| t <sub>wQ</sub> (min)  | A or B       | Q           |   | 45         | 65   |      | 45   | 65   |      | ns   |
| t <sub>wQ</sub>        | A or B       | Q           |   | 3.08       | 3.42 | 3.76 | 2.76 | 3.03 | 3.37 | μs   |

<sup>¶</sup> t<sub>PLH</sub> = propagation delay time, low-to-high-level output

t<sub>PHL</sub> = propagation delay time, high-to-low-level output

t<sub>wQ</sub> = width of pulse at output Q

NOTE 8: See General Information Section for load circuits and voltage waveforms.

3

TTL DEVICES

# TYPES SN54L122, SN54L123, RETRIGGERABLE MONOSTABLE MULTIVIBRATORS

## recommended operating conditions

|                  |   | SN54L*         |     |      | UNIT |
|------------------|---|----------------|-----|------|------|
|                  |   | MIN            | NOM | MAX  |      |
| V <sub>CC</sub>  | Supply voltage  | 4.5            | 5   | 5.5  | V    |
| I <sub>OH</sub>  | High-level output current   |                |     | -0.4 | mA   |
| I <sub>OL</sub>  | Low-level output current  |                |     | 8    | mA   |
| t <sub>w</sub>   | Pulse width   | 50             |     |      | ns   |
| R <sub>ext</sub> | External timing resistance  | 5              |     | 25   | kΩ   |
| C <sub>ext</sub> | External capacitance  | No restriction |     |      |      |
|                  | Wiring capacitance at R <sub>ext</sub> /C <sub>ext</sub> terminal |                |     | 50   | pF   |
| T <sub>A</sub>   | Operating free-air temperature                                    | -55            |     | 125  | °C   |

## electrical characteristics over recommended free-air operating temperature range (unless otherwise noted)

| PARAMETER       | TEST CONDITIONS†                        | 'L122  |   |     | 'L123 |      |     | UNIT |    |
|-----------------|---|--|---|-----|-------|------|-----|------|----|
|                 |   | MIN  | TYP‡  | MAX | MIN   | TYP‡ | MAX |      |    |
| V <sub>IH</sub> | High-level input voltage                | 2  |   |     | 2     |      |     | V    |    |
| V <sub>IL</sub> | Low-level input voltage                 |  |   | 0.8 |       |      | 0.8 | V    |    |
| V <sub>IK</sub> | Input clamp voltage                     | V <sub>CC</sub> = MIN, I <sub>I</sub> = -12 mA               |   |     | -1.5  |      |     | V    |    |
| V <sub>OH</sub> | High-level output voltage               | V <sub>CC</sub> = MIN, I <sub>OH</sub> = -0.4 mA, See Note 1 |   |     | 2.4   | 3.4  | 2.4 | 3.4  | V  |
| V <sub>OL</sub> | Low-level output voltage                | V <sub>CC</sub> = MIN, I <sub>OL</sub> = 8 mA, See Note 1    |   |     | 0.2   | 0.4  | 0.2 | 0.4  | V  |
| I <sub>I</sub>  | Input current at maximum input voltage  | V <sub>CC</sub> = MAX, V <sub>I</sub> = 5.5 V                |   |     | 1     |      | 1   | mA   |    |
| I <sub>IH</sub> | High-level input current                | Data inputs  | V <sub>CC</sub> = MAX, V <sub>I</sub> = 2.4 V |     |       | 20   |     | 20   | μA |
|                 |   | Clear input  |   |     |       | 40   |     | 40   |    |
| I <sub>IL</sub> | Low-level input current                 | Data inputs  | V <sub>CC</sub> = MAX, V <sub>I</sub> = 0.4 V |     |       | -0.8 |     | -0.8 | mA |
|                 |   | Clear input  |   |     |       | -1.6 |     | -1.6 |    |
| I <sub>OS</sub> | Short-circuit output current*           | V <sub>CC</sub> = MAX, See Note 9                            |   |     | -5    | -20  | -5  | -20  | mA |
| I <sub>CC</sub> | Supply current (quiescent or triggered) | V <sub>CC</sub> = MAX, See Notes 10 and 11                   |   |     | 11    | 14   | 23  | 33   | mA |

† For conditions shown as MIN or MAX, use the value specified under recommended operating conditions.

‡ All typical values are at V<sub>CC</sub> = 5 V, T<sub>A</sub> = 25°C.

\* Not more than one output should be shorted at a time.

NOTES: 9. Ground C<sub>ext</sub> to measure V<sub>OH</sub> at Q, V<sub>OL</sub> at  $\bar{Q}$ , or I<sub>OS</sub> at Q. C<sub>ext</sub> is open to measure V<sub>OH</sub> at  $\bar{Q}$ , V<sub>OL</sub> at Q, or I<sub>OS</sub> at  $\bar{Q}$ .

10. Quiescent I<sub>CC</sub> is measured (after clearing) with 2.4 V applied to all clear and A inputs, B inputs grounded, all outputs open, C<sub>ext</sub> = 0.02 μF, and R<sub>ext</sub> = 25 kΩ. R<sub>int</sub> of 'L122 is open.

11. I<sub>CC</sub> is measured in the triggered state with 2.4 V applied to all clear and B inputs, A inputs grounded, all outputs open, C<sub>ext</sub> = 0.02 μF, and R<sub>ext</sub> = 25 kΩ. R<sub>int</sub> of 'L122 is open.

## switching characteristics, V<sub>CC</sub> = 5 V, T<sub>A</sub> = 25°C, see note 8

| PARAMETER <sup>¶</sup> | FROM (INPUT) | TO (OUTPUT) | TEST CONDITIONS   | 'L122 |     |     | 'L123 |     |     | UNIT |    |
|------------------------|--------------|-------------|---|-------|-----|-----|-------|-----|-----|------|----|
|                        |              |             |   | MIN   | TYP | MAX | MIN   | TYP | MAX |      |    |
| t <sub>PLH</sub>       | A            | Q           | C <sub>ext</sub> = 0, R <sub>ext</sub> = 5 kΩ, C <sub>L</sub> = 15 pF, R <sub>L</sub> = 800 Ω       | 44    | 66  |     | 44    | 66  |     | ns   |    |
|                        | B            | Q           |   | 38    | 56  |     | 38    | 56  |     |      |    |
| t <sub>PHL</sub>       | A            | $\bar{Q}$   |   | 60    | 80  |     | 60    | 80  |     | ns   |    |
|                        | B            | $\bar{Q}$   |   | 54    | 72  |     | 54    | 72  |     |      |    |
| t <sub>PHL</sub>       | Clear        | Q           |   | 36    | 54  |     | 36    | 54  |     | ns   |    |
| t <sub>PLH</sub>       |              | $\bar{Q}$   |   | 60    | 80  |     | 60    | 80  |     |      |    |
| t <sub>wQ</sub> (min)  | A or B       | Q           | 90  | 135   |     | 90  | 135   |     | ns  |      |    |
| t <sub>wQ</sub>        | A or B       | Q           | C <sub>ext</sub> = 400 pF, R <sub>ext</sub> = 10 kΩ, C <sub>L</sub> = 15 pF, R <sub>L</sub> = 800 Ω |       |     | 1.7 | 1.9   | 2.1 | 1.3 | 2.1  | μs |

<sup>¶</sup> t<sub>PLH</sub> ≡ propagation delay time, low-to-high-level output

t<sub>PHL</sub> ≡ propagation delay time, high-to-low-level output

t<sub>wQ</sub> ≡ width of pulse at output Q

NOTE 8: See General Information Section for load circuits and voltage waveforms.

3

TTL DEVICES

# TYPES SN54LS122, SN54LS123, SN74LS122, SN74LS123 RETRIGGERABLE MONOSTABLE MULTIVIBRATORS

## recommended operating conditions

|  | SN54LS'        |     |      | SN74LS'        |     |      | UNIT        |
|--|----------------|-----|------|----------------|-----|------|-------------|
|  | MIN            | NOM | MAX  | MIN            | NOM | MAX  |             |
| Supply voltage, $V_{CC}$                         | 4.5            | 5   | 5.5  | 4.75           | 5   | 5.25 | V           |
| High-level output current, $I_{OH}$              |                |     | -400 |                |     | -400 | $\mu A$     |
| Low-level output current, $I_{OL}$               |                |     | 4    |                |     | 8    | mA          |
| Pulse width, $t_w$                               | 40             |     |      | 40             |     |      | ns          |
| External timing resistance, $R_{ext}$            | 5              |     | 180  | 5              |     | 260  | $k\Omega$   |
| External capacitance, $C_{ext}$                  | No restriction |     |      | No restriction |     |      |             |
| Wiring capacitance at $R_{ext}/C_{ext}$ terminal |                |     | 50   |                |     | 50   | pF          |
| Operating free-air temperature, $T_A$            | -55            |     | 125  | 0              |     | 70   | $^{\circ}C$ |

## electrical characteristics over recommended operating free-air temperature range (unless otherwise noted)

| PARAMETER  | TEST CONDITIONS†   | SN54LS' |      |      | SN74LS' |      |      | UNIT    |    |
|--|--|---------|------|------|---------|------|------|---------|----|
|  |  | MIN     | TYP‡ | MAX  | MIN     | TYP‡ | MAX  |         |    |
| $V_{IH}$ High-level input voltage                |  | 2       |      |      | 2       |      |      | V       |    |
| $V_{IL}$ Low-level input voltage                 |  |         |      | 0.7  |         |      | 0.8  | V       |    |
| $V_{IK}$ Input clamp voltage                     |  |         |      | -1.5 |         |      | -1.5 | V       |    |
| $V_{OH}$ High-level output voltage               | $V_{CC} = \text{MIN}, I_L = -18 \text{ mA}$<br>$V_{IL} = V_{IL \text{ max}}, I_{OH} = -400 \mu A$                          | 2.5     | 3.5  |      | 2.7     | 3.5  |      | V       |    |
| $V_{OL}$ Low-level output voltage                | $V_{CC} = \text{MIN}, V_{IH} = 2 \text{ V}, I_{OL} = 4 \text{ mA}$<br>$V_{IL} = V_{IL \text{ max}}, I_{OL} = 8 \text{ mA}$ |         | 0.25 | 0.4  |         | 0.25 | 0.4  | V       |    |
| $I_I$ Input current at maximum input voltage     | $V_{CC} = \text{MAX}, V_I = 7 \text{ V}$   |         |      | 0.1  |         |      | 0.1  | mA      |    |
| $I_{IH}$ High-level input current                | $V_{CC} = \text{MAX}, V_I = 2.7 \text{ V}$   |         |      | 20   |         |      | 20   | $\mu A$ |    |
| $I_{IL}$ Low-level input current                 | $V_{CC} = \text{MAX}, V_I = 0.4 \text{ V}$   |         |      | -0.4 |         |      | -0.4 | mA      |    |
| $I_{OS}$ Short-circuit output current*           | $V_{CC} = \text{MAX}$  | -20     |      | -100 | -20     |      | -100 | mA      |    |
| $I_{CC}$ Supply current (quiescent or triggered) | $V_{CC} = \text{MAX},$ See Note 13   |         |      | 6    | 11      |      | 6    | 11      | mA |
|  |  |         |      | 12   | 20      |      | 12   | 20      | mA |

† For conditions shown as MIN or MAX, use the appropriate value specified under recommended operating conditions.

‡ All typical values are at  $V_{CC} = 5 \text{ V}, T_A = 25^{\circ}C$ .

\* Not more than one output should be shorted at a time and duration of the short circuit should not exceed one second.

NOTES: 12. To measure  $V_{OH}$  at Q,  $V_{OL}$  at  $\bar{Q}$ , or  $I_{OS}$  at Q, ground  $R_{ext}/C_{ext}$ , apply 2 V to B and clear, and pulse A from 2 V to 0 V.

13. With all outputs open and 4.5 V applied to all data and clear inputs,  $I_{CC}$  is measured after a momentary ground, then 4.5 V, is applied to clock.

## switching characteristics, $V_{CC} = 5 \text{ V}, T_A = 25^{\circ}C$ (see note 8)

| PARAMETER†           | FROM (INPUT) | TO (OUTPUT) | TEST CONDITIONS  | MIN | TYP | MAX | UNIT    |
|----------------------|--------------|-------------|--|-----|-----|-----|---------|
| $t_{PLH}$            | A            | Q           | $C_{ext} = 0, R_{ext} = 5 \text{ k}\Omega,$<br>$C_L = 15 \text{ pF}, R_L = 2 \text{ k}\Omega$                |     | 23  | 33  | ns      |
|                      | B            | Q           |  |     | 23  | 44  |         |
| $t_{PHL}$            | A            | $\bar{Q}$   |  |     | 32  | 45  | ns      |
|                      | B            | $\bar{Q}$   |  |     | 34  | 56  |         |
| $t_{PHL}$            | Clear        | Q           |  |     | 20  | 27  | ns      |
| $t_{PLH}$            | Clear        | $\bar{Q}$   |  |     | 28  | 45  |         |
| $t_{wQ}(\text{min})$ | A or B       | Q           |  |     | 116 | 200 | ns      |
| $t_{wQ}$             | A or B       | Q           | $C_{ext} = 1000 \text{ pF}, R_{ext} = 10 \text{ k}\Omega,$<br>$C_L = 15 \text{ pF}, R_L = 2 \text{ k}\Omega$ | 4   | 4.5 | 5   | $\mu s$ |

†  $t_{PLH}$  = propagation delay time, low-to-high-level output

$t_{PHL}$  = propagation delay time, high-to-low-level output

$t_{wQ}$  = width of pulse at output Q

NOTE 8: See General Information Section for load circuits and voltage waveforms.

3

TTL DEVICES



# TYPES SN54122, SN54123, SN54130, SN54L122, SN54L123, SN74122, SN74123, SN74130 RETRIGGERABLE MONOSTABLE MULTIVIBRATORS

## TYPICAL APPLICATION DATA FOR '122, '123, '130, 'L122, 'L123

For pulse widths when  $C_{ext} \leq 1000$  pF, See Figures 4 and 5.

The output pulse is primarily a function of the external capacitor and resistor. For  $C_{ext} > 1000$  pF, the output pulse width ( $t_w$ ) is defined as:

$$t_w = K \cdot R_T \cdot C_{ext} \left( 1 + \frac{0.7}{R_T} \right)$$

where

K is 0.32 for '122, 0.28 for '123, '130,  
0.37 for 'L122, 0.33 for 'L123

$R_T$  is in  $K\Omega$  (internal or external timing resistance.)

$C_{ext}$  is in pF

$t_w$  is in nanoseconds

To prevent reverse voltage across  $C_{ext}$ , it is recommended that the method shown in Figure 2 be employed when using electrolytic capacitors and in applications utilizing the clear function. In all applications using the diode, the pulse width is:

$$t_w = K_D \cdot R_T \cdot C_{ext} \left( 1 + \frac{0.7}{R_T} \right)$$

$K_D$  is 0.28 for '122, 0.25 for '123, '130,  
0.33 for 'L122, 0.29 for 'L123

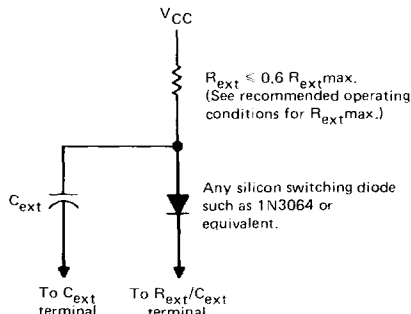

**TIMING COMPONENT CONNECTIONS WHEN  $C_{ext} > 1000$  pF AND CLEAR IS USED**  
FIGURE 2

Applications requiring more precise pulse widths (up to 28 seconds) and not requiring the clear feature can best be satisfied with the '121 or 'L121.

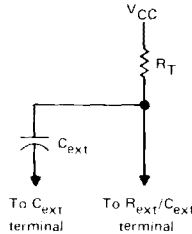

**TIMING COMPONENT CONNECTIONS**  
FIGURE 3

### '122, '123, '130 TYPICAL OUTPUT PULSE WIDTH VS EXTERNAL TIMING CAPACITANCE

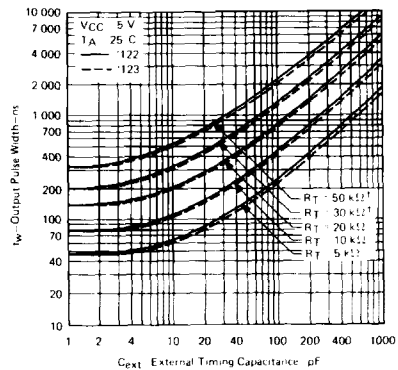

FIGURE 4

### 'L122 TYPICAL OUTPUT PULSE WIDTH VS EXTERNAL TIMING CAPACITANCE

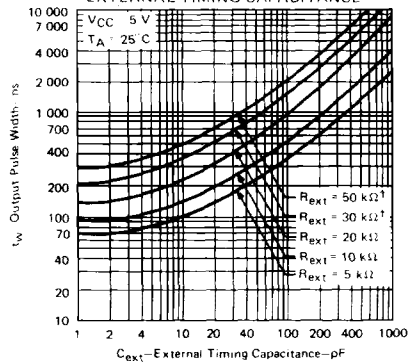

FIGURE 5

<sup>†</sup> These values of resistance exceed the maximum recommended for use over the full temperature range of the SN54' and SN54L' circuits.

# TYPES SN54LS122, SN54LS123, SN74LS122, SN74LS123 RETRIGGERABLE MONOSTABLE MULTIVIBRATORS

## TYPICAL APPLICATION DATA FOR 'LS122, 'LS123

The basic output pulse width is essentially determined by the values of external capacitance and timing resistance. For pulse widths when  $C_{ext} \leq 1000$  pF, use Figure 7, or may be defined as:

$$t_w \approx K \cdot R_T \cdot C_{ext}$$

When  $C_{ext} \geq 1$   $\mu$ F, the output pulse width is defined as:

$$t_w \approx 0.33 \cdot R_T \cdot C_{ext}$$

Where

$K$  is multiplier factor, see Figure 8

$R_T$  is in K ohms (internal or external timing resistance)

$C_{ext}$  is in pF

$t_w$  is in nanoseconds

For maximum noise immunity, system ground should be applied to the  $C_{ext}$  node, even though the  $C_{ext}$  node is already tied to the ground lead internally. Due to the timing scheme used by the 'LS122 and 'LS123, a switching diode is not required to prevent reverse biasing when using electrolytic capacitors.

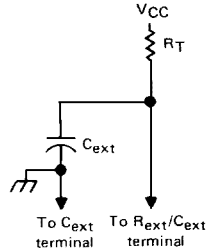

TIMING COMPONENT CONNECTIONS

FIGURE 6

### 'LS122, 'LS123 TYPICAL OUTPUT PULSE WIDTH VS EXTERNAL TIMING CAPACITANCE

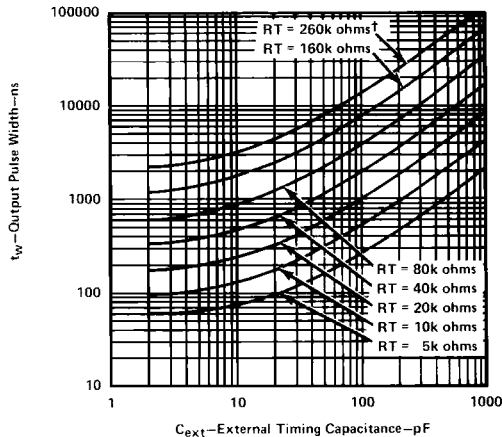

<sup>1</sup> This value of resistance exceeds the maximum recommended for use over the full temperature range of the SN54LS circuits.

FIGURE 7

# TYPES SN54LS122, SN54LS123, SN74LS122, SN74LS123 RETRIGGERABLE MONOSTABLE MULTIVIBRATORS

## TYPICAL APPLICATION DATA FOR 'LS122, 'LS123†

MULTIPLIER FACTOR  
vs  
EXTERNAL CAPACITOR

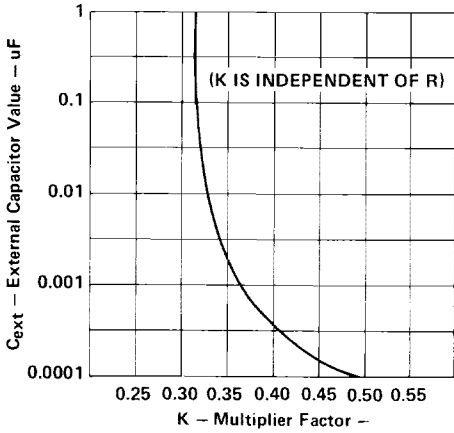

FIGURE 8

DISTRIBUTION OF UNITS  
vs  
OUTPUT PULSE WIDTH

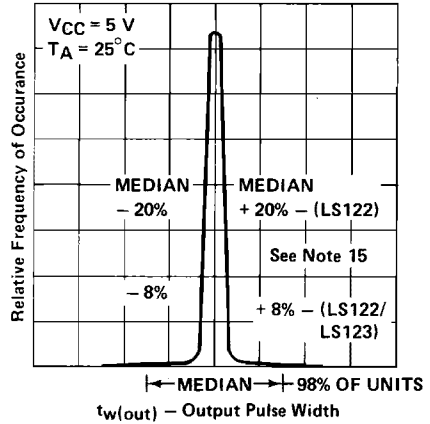

FIGURE 9

VARIATION IN OUTPUT PULSE WIDTH  
vs  
SUPPLY VOLTAGE

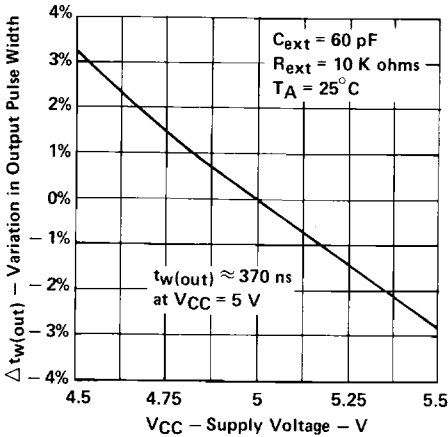

FIGURE 10

VARIATION IN OUTPUT PULSE WIDTH  
vs  
FREE-AIR TEMPERATURE

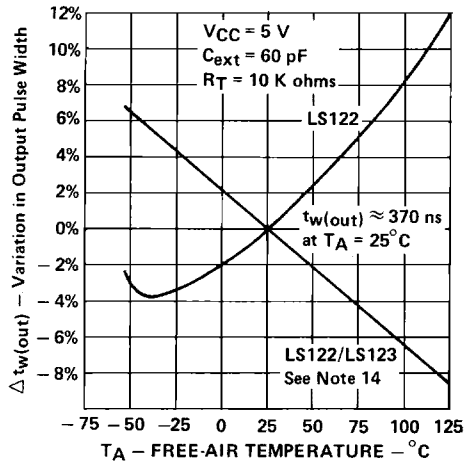

FIGURE 11

NOTE 14: For the 'LS122, the internal timing resistor,  $R_{int}$  was used. For the 'LS122/123, an external timing resistor was used for  $R_T$ .

†Data for temperatures below 0°C and above 70°C and for supply voltages below 4.75 V and above 5.25 V are applicable for SN54LS122 and SN54LS123 only.