

Rev	AWO #	Description	Date	Appr
-		RELEASED	5/22/15	

APPROVED: _____
 DATE: _____ TITLE: _____

DE09-HD-PX-SS

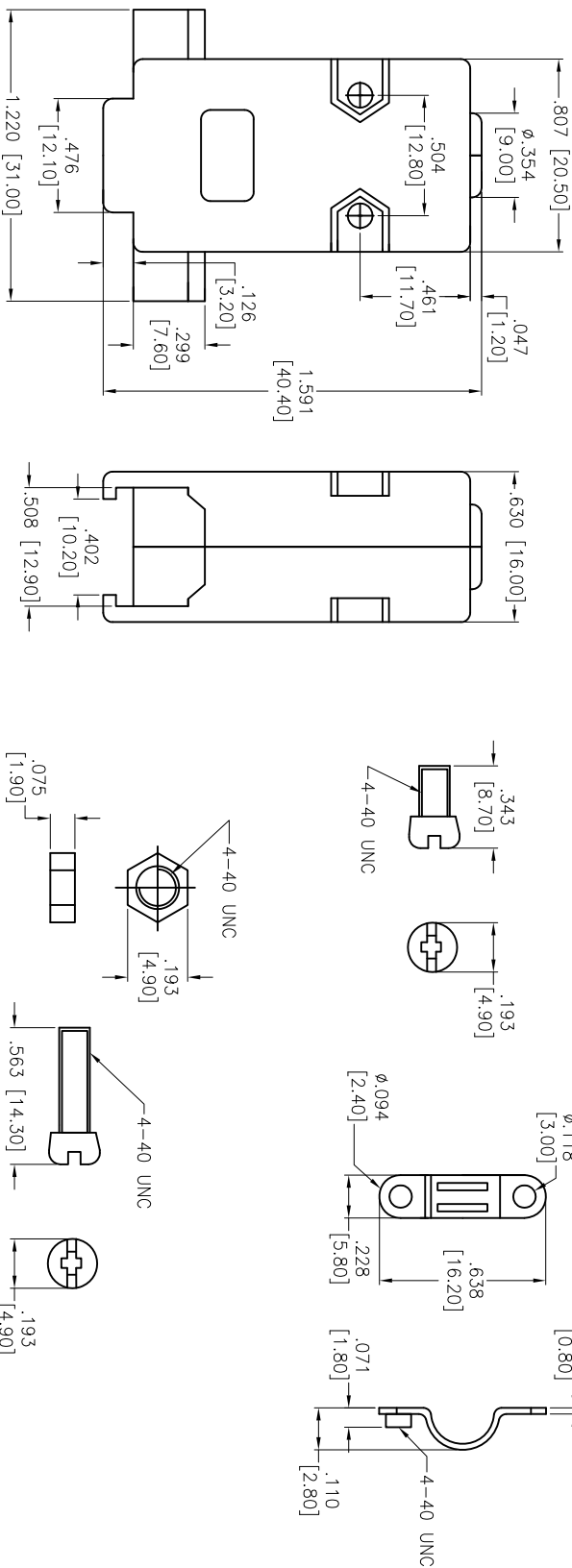
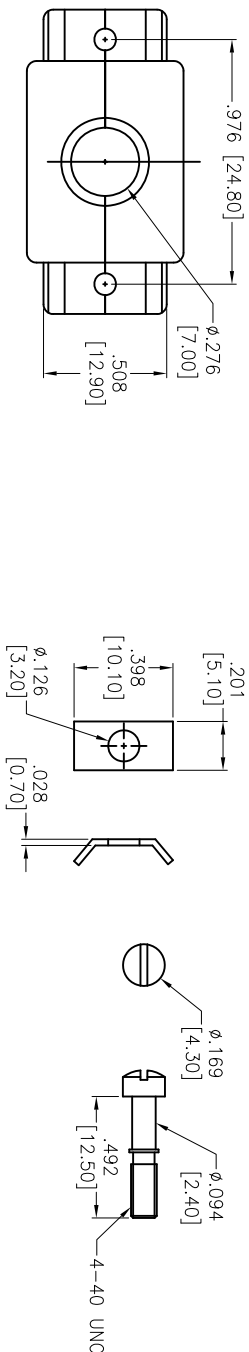

ADAM P/N	HOOD COLOR
DXXX-HD-PB-SS	BLACK PLASTIC
DXXX-HD-PN-SS	CHROME PLASTIC
DXXX-HD-PY-SS	GRAY PLASTIC

SPECIFICATIONS:
 Material:
 Insulator: ABS, rated UL 94HB
 Insulator color: Black
 Hardware: Steel, Chromate plated
 Environmental:
 Lead free, RoHS compliant



UNLESS OTHERWISE SPECIFIED ALL DIMENSIONS ARE INCHES [MM]	
TOLERANCES: EXCEPT AS NOTED	
INCHES	
.X ± .10	ØX ± .10
.XX ± .020	ØXX ± .015
.XXX ± .015	ØXXX ± .010
APPROVALS	
DRAWN	HR
CHECKED	LL
APPROVED	
DATE	DATE

ADAM TECH
 909 Railway Avenue, Union, NJ 07083
 Phone: 908-687-5000 Fax: 908-687-5710

TITLE	D-SUB HOOD, SHORT SCREWS	
SIZE	PART NO.	REV.
X	DXXX-HD-PX-SS	-
REF: S00064T	SCALE: NTS	SHEET 1 OF 5

6

5

4

3

2

1

Rev	AWO #	Description	Date	Appr
		SEE SHT 1 OF 5 FOR REVISION		

APPROVED: _____

DATE: _____ TITLE: _____

DA15-HD-PX-SS

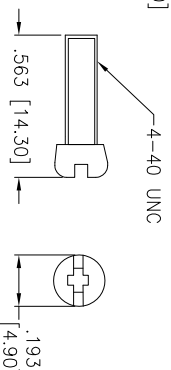
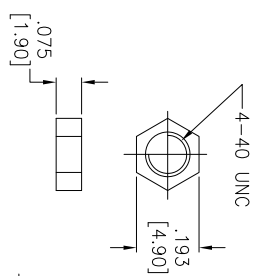
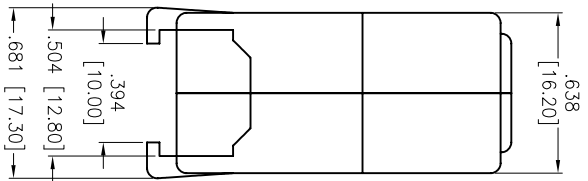
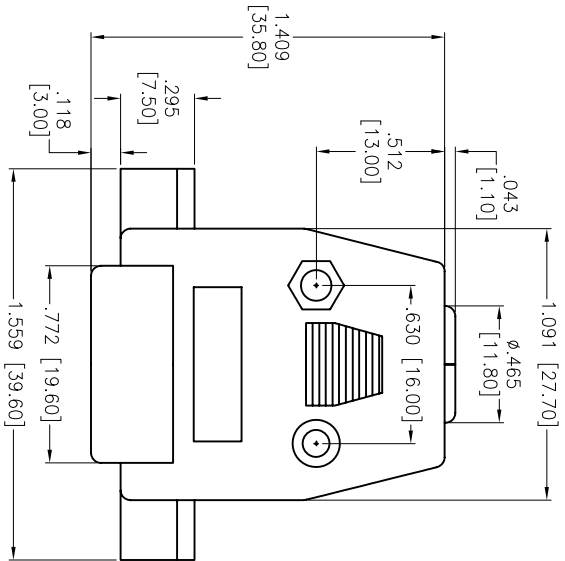
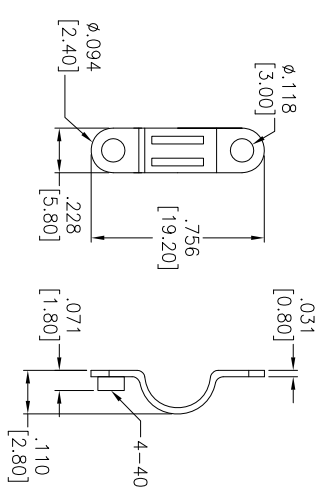
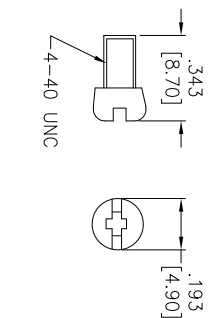
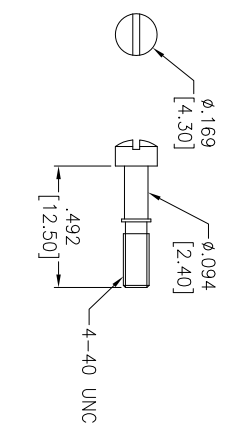
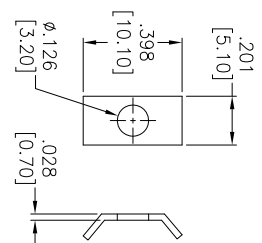
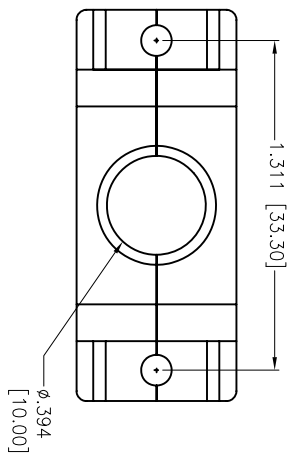

UNLESS OTHERWISE SPECIFIED
ALL DIMENSIONS ARE INCHES [MM]
TOLERANCES: EXCEPT AS NOTED

.X	± .10	ØX	± .10
.XX	± .020	ØXX	± .015
.XXX	± .015	ØXXX	± .010

INCHES

HOLDS

ADAM TECH
909 Railway Avenue, Union, NJ 07083
Phone: 908-687-5000 Fax: 908-687-5710

D-SUB HOOD, SHORT SCREWS

DRAWN	HR	5/22/15	SIZE	PART NO.	REV.
CHECKED	LL	5/22/15	X	DXXX-HD-PX-SS	-
APPROVED			REF:	S00064T	SCALE: NTS

6

5

4

3

2

1

6

5

4

3

2

1

Rev	AWO #	Description	Date	Appr
		SEE SH1 1 OF 5 FOR REVISION		

APPROVED: _____

DATE: _____ TITLE: _____

DB25-HD-PX-SS

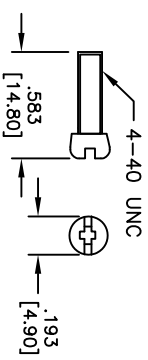
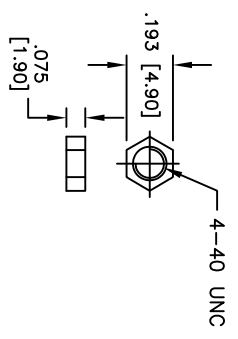
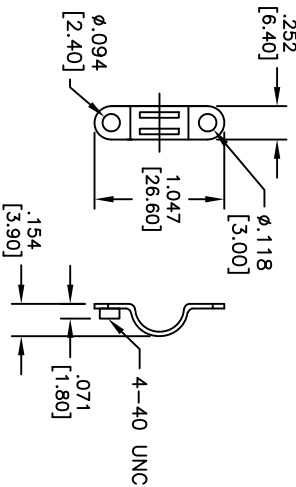
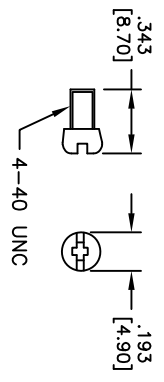
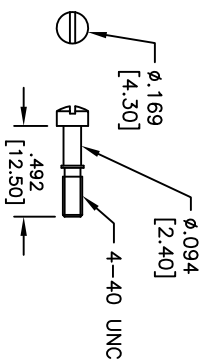
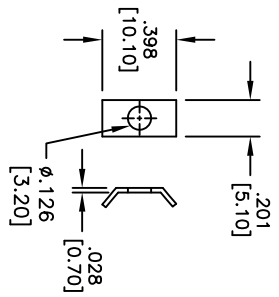
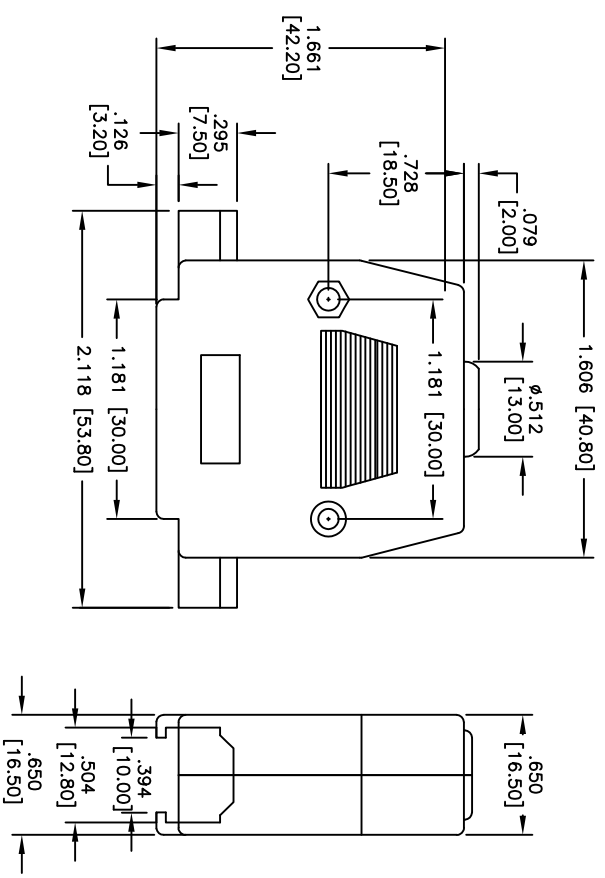
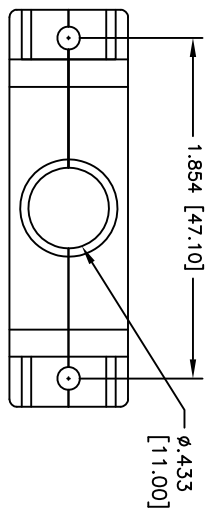

UNLESS OTHERWISE SPECIFIED
ALL DIMENSIONS ARE IN INCHES [MM]
TOLERANCES: EXCEPT AS NOTED
INCHES Holes ±.10
.XX ±.020
.XXX ±.015
APPROVALS DATE

ADAM TECH
909 Railway Avenue, Union, NJ 07083
Phone: 908-687-5000 Fax: 908-687-5710

D-SUB HOOD, SHORT SCREWS

DRAWN	HR	5/22/15	SIZE	PART NO.	REV.
CHECKED	LL	5/22/15	X	DXXX-HD-PX-SS	-
APPROVED			REF:	S000&T	SCALE: NTS
					SHEET 3 OF 5

6

5

4

3

2

1

6

5

4

3

2

1

Rev	AWC #	Description	Date	Appr
		SEE SH1 1 OF 5 FOR REVISION		

APPROVED: _____
 DATE: _____ TITLE: _____

DC37--HD--PX--SS

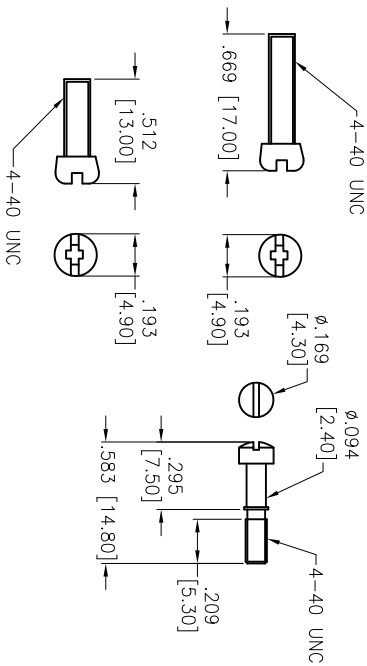
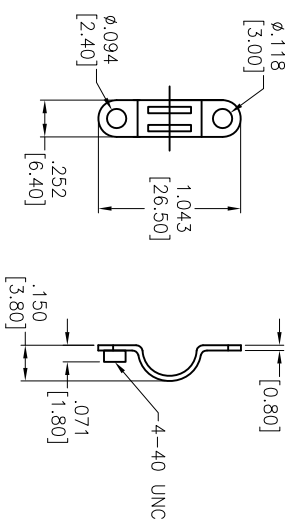
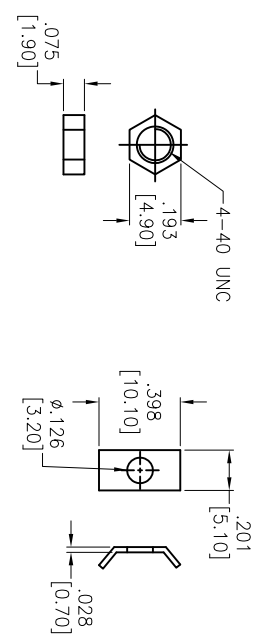
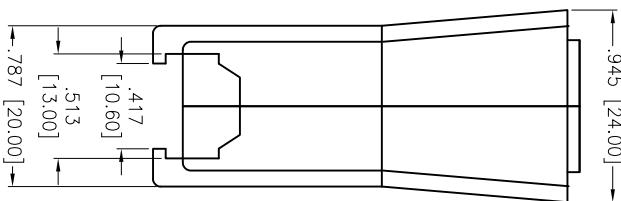
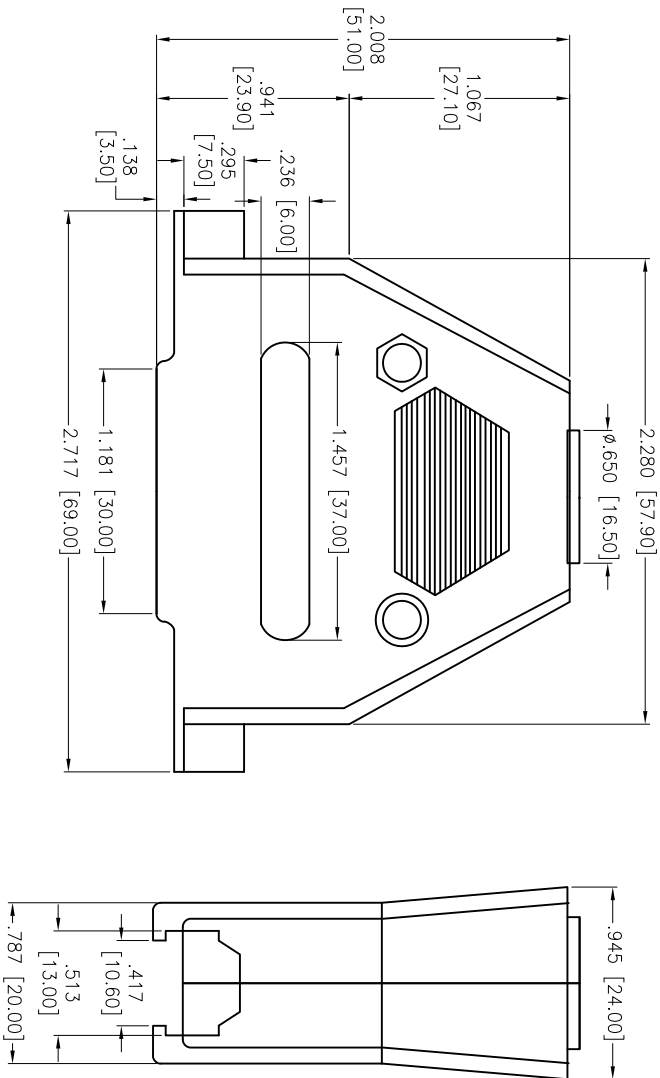
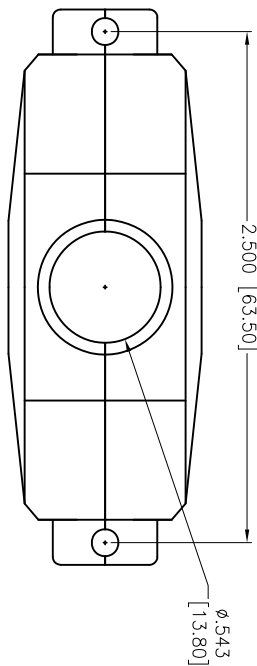

UNLESS OTHERWISE SPECIFIED
 ALL DIMENSIONS ARE IN INCHES [MM]
 TOLERANCES: EXCEPT AS NOTED
 INCHES ± .10
 .XX ± .020
 .XXX ± .015
 .XXX ± .010

ADAM TECH
 909 Railway Avenue, Union, NJ 07083
 Phone: 908-687-5000 Fax: 908-687-5710

D-SUB HOOD, SHORT SCREWS

APPROVED	HR	5/22/15	SIZE	PART NO.	REV.
CHECKED	LL	5/22/15	X	DXXX-HD-PX-SS	-
			REF:	S0002AT	SHEET 4 OF 5

6

5

4

3

2

1

6

5

4

3

2

1

Rev	AWO #	Description	Date	Appr
		SEE SHIT 1 OF 5 FOR REVISION		

APPROVED: _____
 DATE: _____ TITLE: _____

DD50-HD-PX-SS

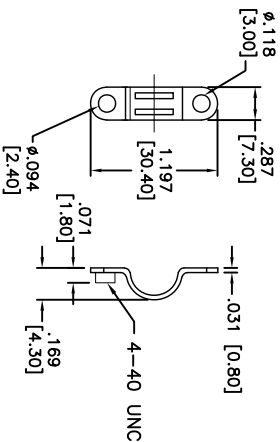
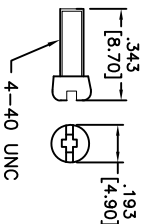
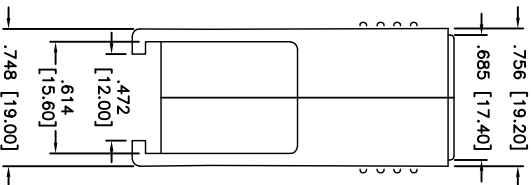
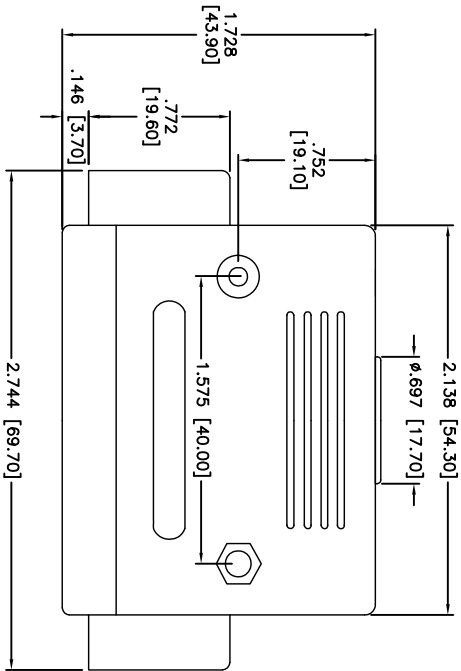
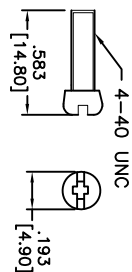
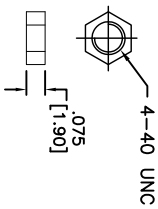
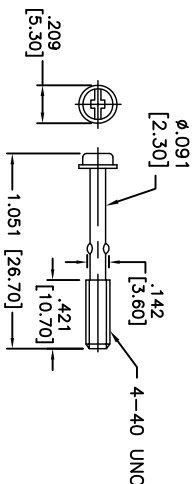
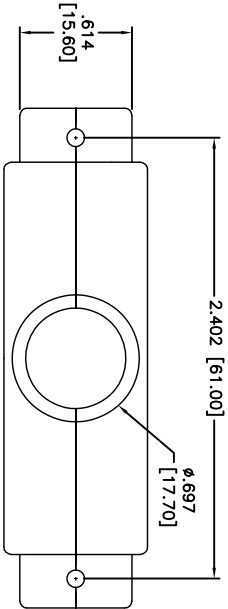

A

B

C

D

A

B

C

D

ADAM TECH

909 Rahway Avenue, Union, NJ 07083
 Phone: 908-687-5000 Fax: 908-687-5710

D-SUB HOOD, SHORT SCREWS

UNLESS OTHERWISE SPECIFIED ALL DIMENSIONS ARE MM [INCHES] TOLERANCES: EXCEPT AS NOTED		TITLE	
INCHES	± .10	HOLES	± .10
Ø X	± .020	Ø XX	± .015
.XXX	± .015	Ø XXX	± .010
APPROVALS		DATE	
DRAWN	HR	5/22/15	
CHECKED	LL	5/22/15	
APPROVED			
SIZE	PART NO.	REV.	
X	DXXX-HD-PX-SS	-	
REF:	S00084T	SCALE:	NTS
		SHEET	5 OF 5

6

5

4

3

2

1