

2.4 GHz Metamaterial-Inspired Antenna using a Split Ring Resonator structure

1. Features

- LAN, Bluetooth 2.4 – 2.5 GHz (2.4 - 2.5 GHz Antenna for WLAN, Bluetooth, etc.)
- Compact Size
- High Efficiency
- Surface Mount Device
- Embossed Reel Package

2. Part Number

RAC00024-R

3200 (3200-piece T&R)

3. Shape, Dimensions and Weight

3.1. Shape

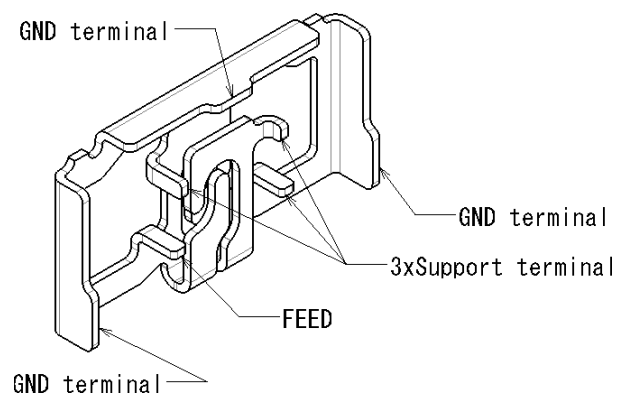
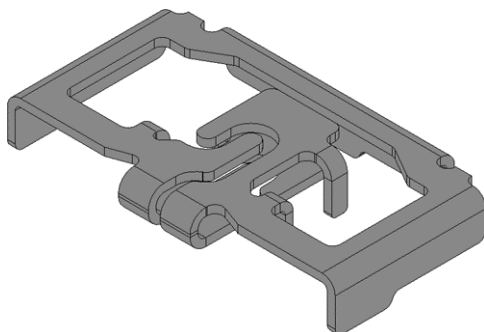

2.4 GHz Metamaterial-Inspired Antenna using a Split Ring Resonator structure

3.2. Dimensions

w 12.5 x d 7.25 x h 1.9 mm

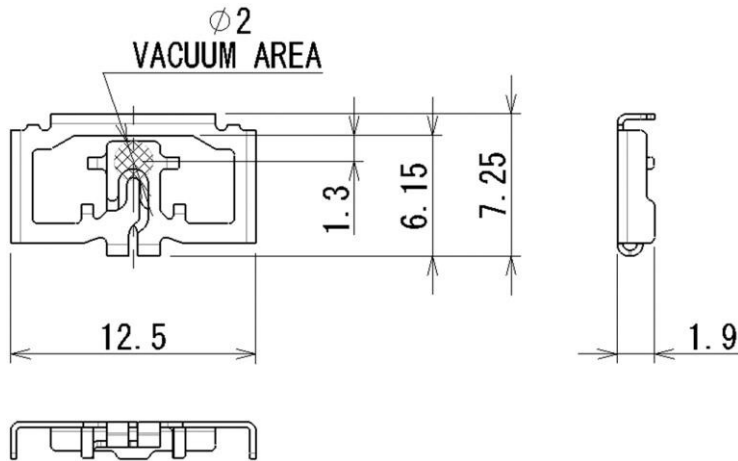

3.3. (Weight)

0.22 g Typical

3.4. Plating

None

3.5. Type

Split Ring

4. RF Characteristics

4.1. Frequency Range

2.4 - 2.5 GHz

4.2. Impedance 50Ω

4.3. VSWR (Voltage Standing Wave Ratio)

50x30mm VSWR (VSWR characteristics of the antenna on a referenceboard of 50 x 30mm)

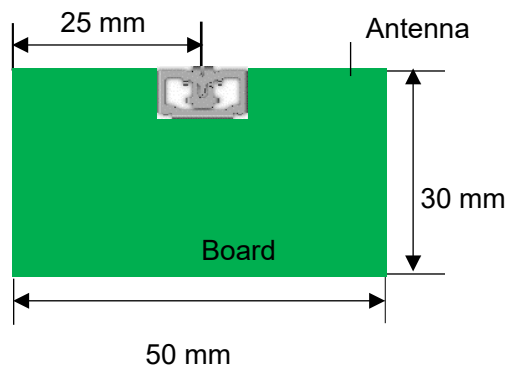

2.4 GHz Metamaterial-Inspired Antenna using a Split Ring Resonator structure

VSWR < 2.0 (Frequency Range: 2.4 – 2.5 GHz)

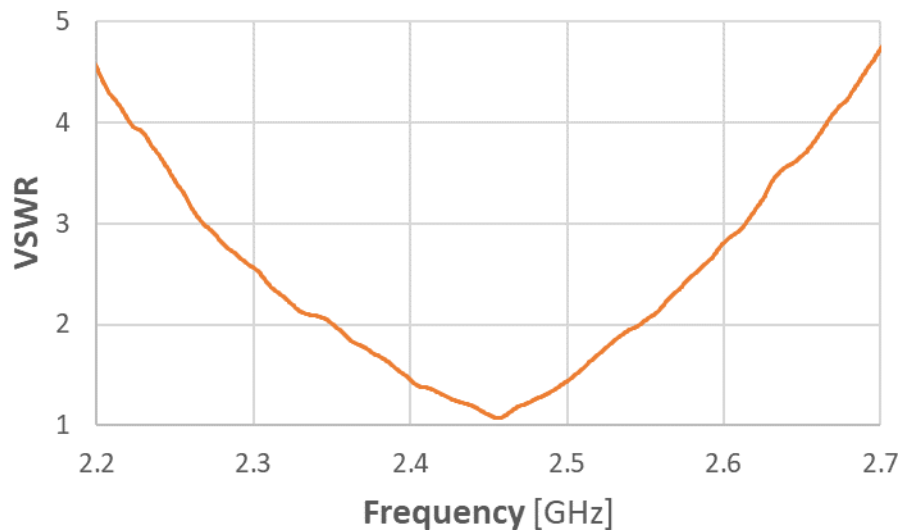

4.4 Radiation Efficiency

50x30mm (Radiation efficiency of the antenna mounted on a reference board of 50 x 30mm, excluding cable and feeder line loss)

Radiation Efficiency > 85 % Frequency Range: 2.4 - 2.5 GHz

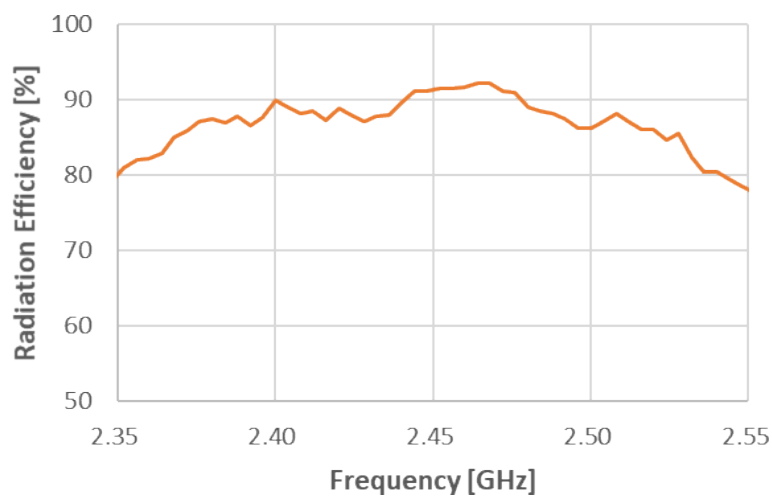

2.4 GHz Metamaterial-Inspired Antenna using a Split Ring Resonator structure

4.5. Radiation Pattern:

50x30mm Radiation pattern of the antenna mounted on a reference board of 50 x 30mm

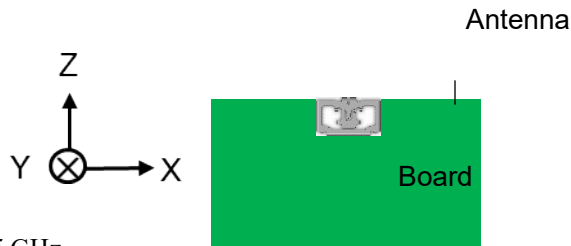

Radiation Pattern @2.45 GHz

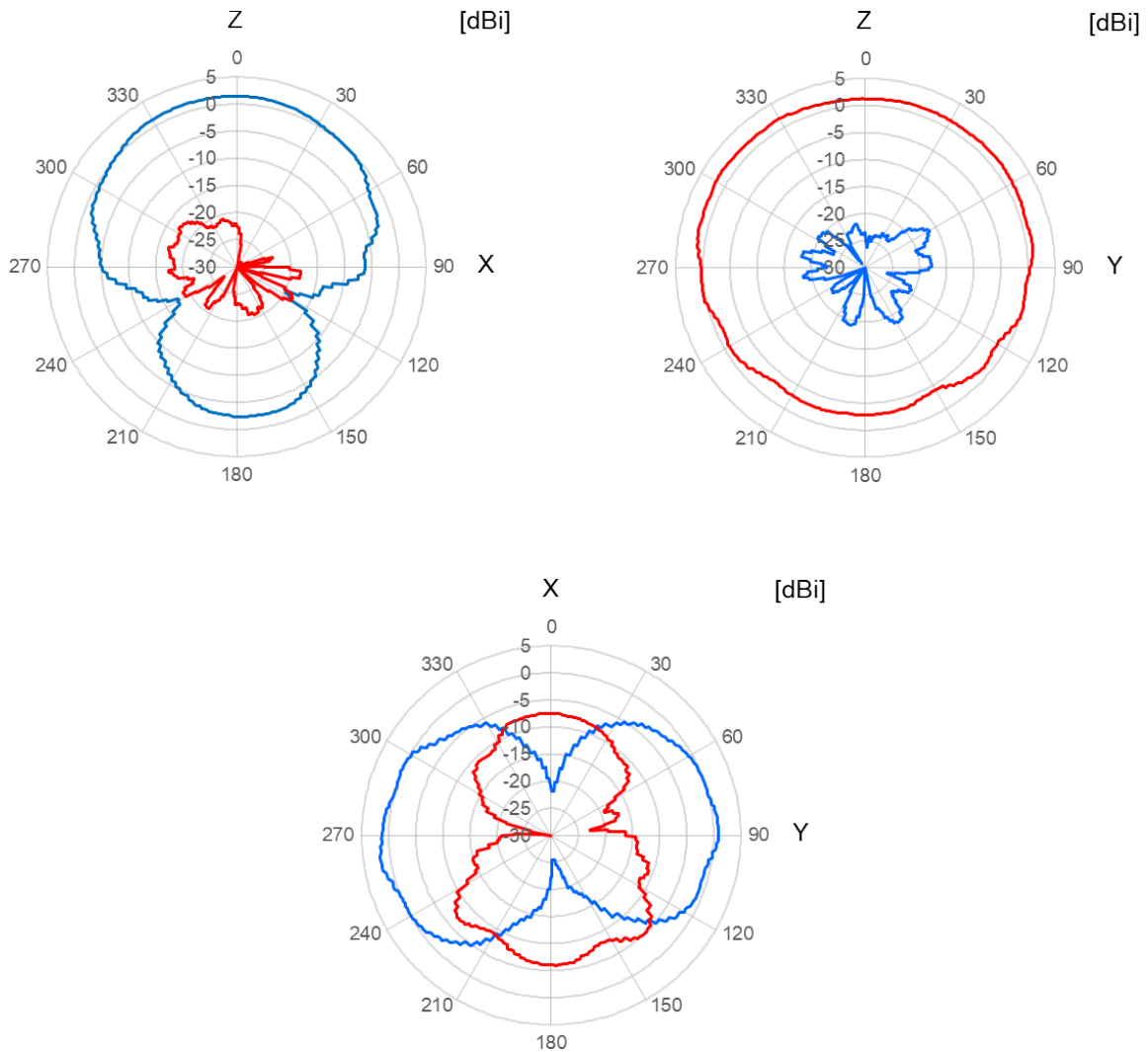

blue line: Horizontal Polarization red line: Vertical Polarization

2.4 GHz Metamaterial-Inspired Antenna using a Split Ring Resonator structure

5. Environmental Conditions

5.5. Operating Temperature Range

-40 °C to +125 °C

5.6. Storage Conditions

IEC 61760-2

Stock Temperature Range

+5 °C to +40 °C

Relative Humidity 10 % to 75 %

6. Recommended Land Pattern and Reference Board

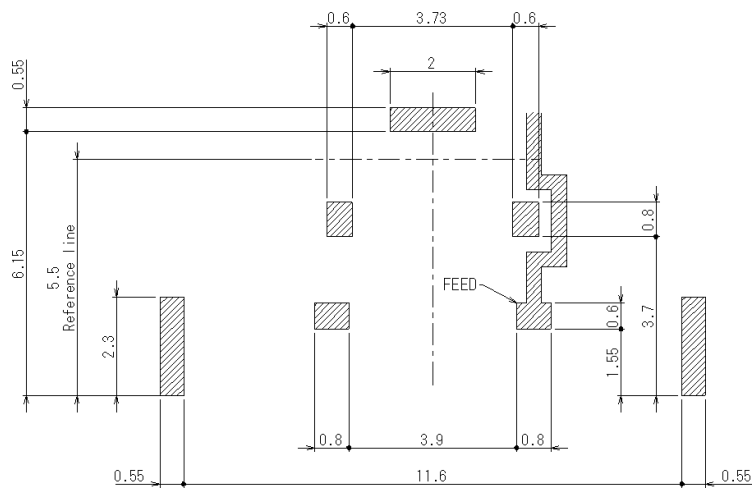

Recommended Land Pattern

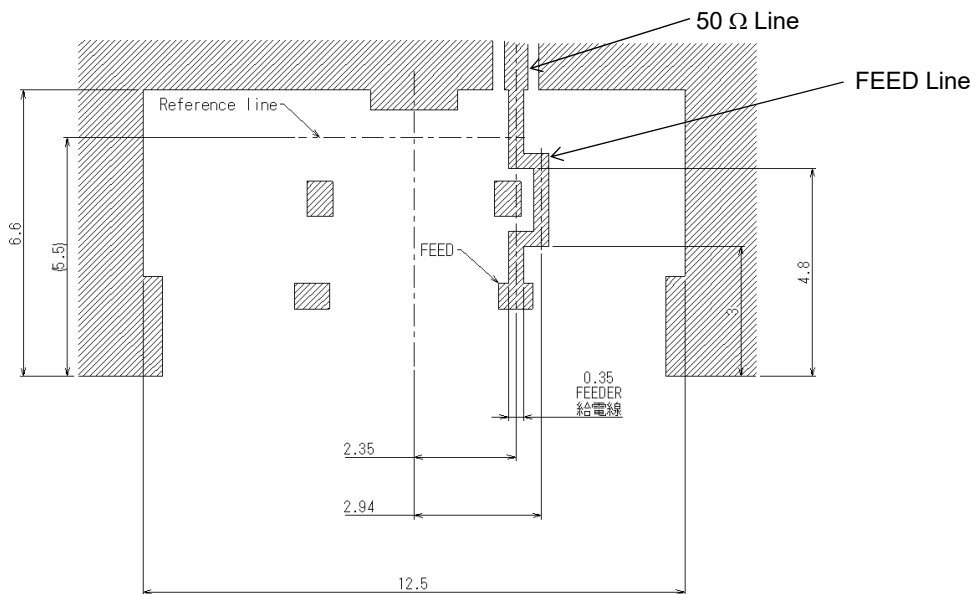

Reference Board

2.4 GHz Metamaterial-Inspired Antenna using a Split Ring Resonator structure

7. Recommended Reflow Temperature Profile

	Temperature	Heating Time
Preheating Temperature	180 to 200 °C Max	120s Max
Main Heating Temperature	220 °C Max	50s Max
Peak Temperature	250 °C Max	-

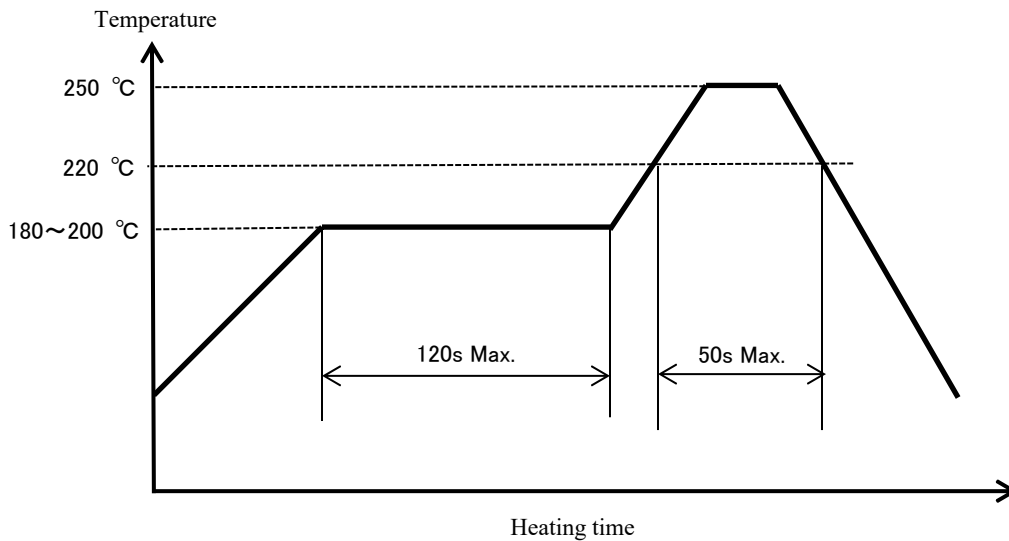

2.4 GHz Metamaterial-Inspired Antenna using a Split Ring Resonator structure

- 8. Packaging
- 8.5. Package Quantity: 3,200 pieces/reel
- 8.6. Embossed Reel Dimensions

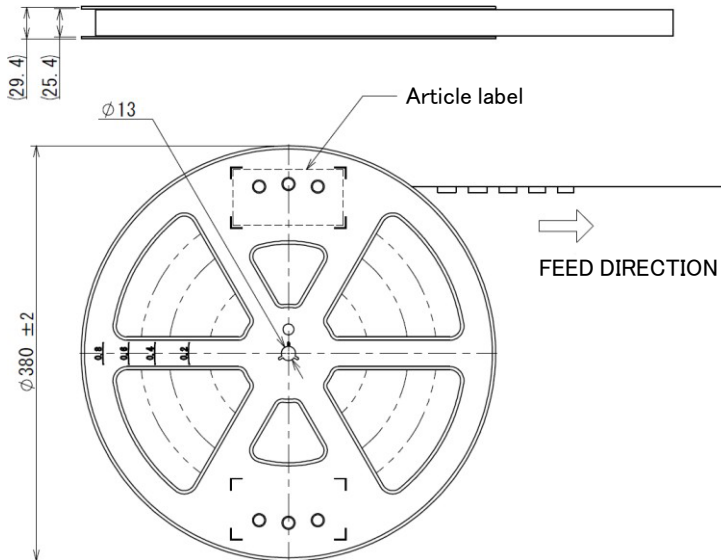

8.7. Tape Dimensions

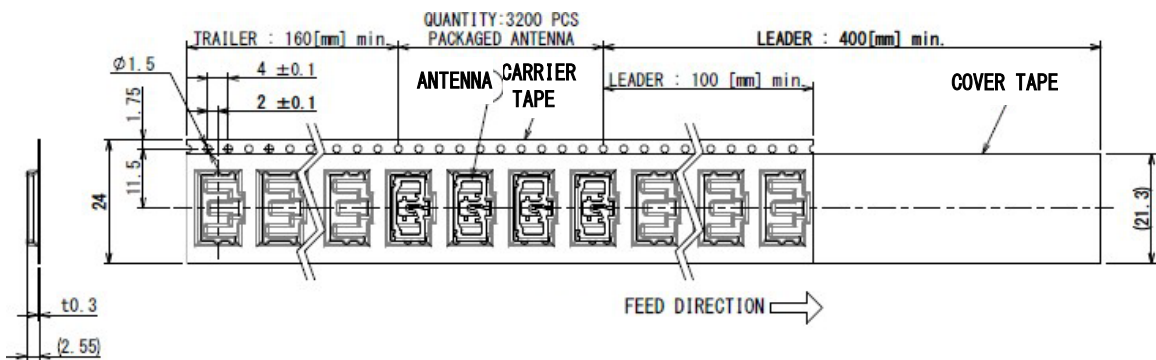

Revision History

Version	Date	Revision
A	23 April 2021	Initial Version
B	29 August 2022	Name Change



2.4 GHz Metamaterial-Inspired Antenna using a Split Ring
Resonator structure
