

EVALUATION KIT
AVAILABLE

High-Efficiency, 26V Step-Up Converters for Main and Subdisplays Using OLEDs and/or White LEDs

General Description

The MAX8608Y/MAX8608Z dual LED drivers use a single inductor to provide two outputs for either organic LED (OLED) power or white LED (WLED) drive in dual-display cell phones. Each output can be configured for either voltage regulation (adjustable up to 26V) for OLED or current regulation (adjustable up to 40mA) for WLED.

The topology integrates a single 1MHz/500kHz PWM step-up converter and two output load switches to minimize size and external components and maximize efficiency. Each output (OUTA, OUTB) is enabled by individual logic inputs for simplicity; however, if ENA is high, ENB is overridden and OUTB becomes disabled. A single CTRL input accepts either an analog or direct-PWM dimming signal for proportional control of the output voltage or current. Internal lowpass filtering eliminates the need for any external filters at CTRL while maintaining low input and output ripple under all conditions.

The MAX8608Y features a T_A derating function to avoid overdriving the LEDs during high ambient temperatures, enabling higher drive current below +40°C. Other features shared by both devices include soft-start, output overvoltage protection, output overcurrent/short-circuit protection, output True Shutdown™, and thermal shutdown.

The MAX8608Y/MAX8608Z are available in a space-saving, 14-pin, 3mm x 3mm TDFN lead-free package.

Applications

OLED Power and/or White LED Backlights
Cell Phones and Smartphones
PDAs, Palmtops, and Wireless Handhelds

True Shutdown is a trademark of Maxim Integrated Products, Inc.



Features

- ◆ For Dual Displays
 - OLED + OLED
 - White LED + OLED
 - White LED + White LED
- ◆ Two Outputs Share One Inductor and One Schottky Diode
- ◆ Output True Shutdown
- ◆ Over 83% Efficiency at 13V to 20V/10mA to 20mA
- ◆ Up to 900mW Output Power
- ◆ Flexible Analog or PWM Dimming Control
- ◆ Selectable 1MHz or 500kHz PWM Operation
- ◆ Temperature Derating (MAX8608Y)
- ◆ Small, Low-Profile External Components
- ◆ 26V Output Overvoltage Protection
- ◆ Optimized for Low Input/Output Ripple
- ◆ Soft-Start Eliminates Inrush Current

Ordering Information

PART	PIN-PACKAGE	TOP MARK	PKG CODE
MAX8608YETD+	14 TDFN 3mm x 3mm T1433-2	ANN	T1433-1
MAX8608ZETD+	14 TDFN 3mm x 3mm T1433-2	ANO	T1433-1

Note: All parts are specified in the -40°C to +85°C extended temperature range.

+Denotes lead-free package.

Pin Configuration

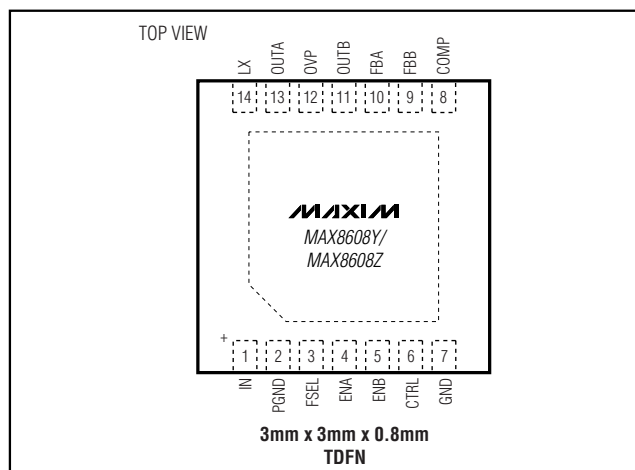

MAX8608Y/MAX8608Z

High-Efficiency, 26V Step-Up Converters for Main and Subdisplays Using OLEDs and/or White LEDs

ABSOLUTE MAXIMUM RATINGS

IN to GND	-0.3V to +7V	Continuous Power Dissipation ($T_A = +70^\circ\text{C}$) 14-Pin TDFN 3mm x 3mm (derate 18.2mW/ $^\circ\text{C}$ above $+70^\circ\text{C}$).....	1454mW
PGND to GND	-0.3V to +0.3V		
LX to GND.....	-0.3V to ($V_{OVP} + 0.3\text{V}$)	Operating Temperature Range	-40 $^\circ\text{C}$ to +85 $^\circ\text{C}$
OVP, OUTA, OUTB to GND.....	-0.3V to +30V	Junction Temperature.....	+150 $^\circ\text{C}$
CTRL to GND.....	-0.3V to the lower of +7V or ($V_{IN} + 2\text{V}$)	Storage Temperature Range	-65 $^\circ\text{C}$ to +150 $^\circ\text{C}$
COMP, FBA, FBB, FSEL, ENA, ENB to GND	-0.3V to ($V_{IN} + 0.3\text{V}$)	Lead Temperature (soldering, 10s).....	+300 $^\circ\text{C}$
I _{LX}	1A _{RMS}		

Stresses beyond those listed under "Absolute Maximum Ratings" may cause permanent damage to the device. These are stress ratings only, and functional operation of the device at these or any other conditions beyond those indicated in the operational sections of the specifications is not implied. Exposure to absolute maximum rating conditions for extended periods may affect device reliability.

ELECTRICAL CHARACTERISTICS

($V_{IN} = 3.0\text{V}$, $V_{OVP} = 20\text{V}$, $L1 = 22\mu\text{H}$, $C_{OVP} = 1\mu\text{F}$, $C_{COMP} = 0.01\mu\text{F}$, $R_{COMP} = 10\text{k}\Omega$, $R_{SENSE} = 13\Omega$, $V_{CTRL} = 1.6\text{V}$, $T_A = -40^\circ\text{C}$ to $+85^\circ\text{C}$, unless otherwise noted. Typical values are at $T_A = +25^\circ\text{C}$.) (Note 1)

PARAMETER	CONDITIONS	MIN	TYP	MAX	UNITS	
Supply Voltage		2.7		6.0	V	
UVLO Threshold	V_{IN} rising or falling	2.05	2.38	2.70	V	
UVLO Hysteresis			140		mV	
Quiescent Current	No switching		0.4	0.8	mA	
Shutdown Supply Current	CTRL = GND, OVP = IN	$T_A = +25^\circ\text{C}$	0.01	1	μA	
		$T_A = +85^\circ\text{C}$	0.01			
OVLO Threshold	V_{OVP} rising	26	27	28	V	
OVLO Hysteresis			2		V	
OVP Input Bias Current	$V_{OVP} = 26\text{V}$, ENA = IN		30	50	75	μA
	OVP = IN, ENA = ENB = GND	$T_A = +25^\circ\text{C}$	0.01	1		
		$T_A = +85^\circ\text{C}$	0.01			
Thermal Protection	Typical hysteresis = 20 $^\circ\text{C}$		+160		$^\circ\text{C}$	
Output Voltage Range	(Note 2)	$(V_{IN} - V_{D1})$		26	V	
ENA, ENB, FSEL Logic Input-Voltage High	$V_{IN} = 2.7\text{V}$ to 6V	1.4			V	
ENA, ENB, FSEL Logic Input-Voltage Low	$V_{IN} = 2.7\text{V}$ to 6V			0.6	V	
ENA, ENB, FSEL Input Leakage	$V_{LOGIC} = 6\text{V}$	$T_A = +25^\circ\text{C}$	0.01	1	μA	
		$T_A = +85^\circ\text{C}$	0.01			
ERROR AMPLIFIER						
CTRL to FBA/FBB Regulation	$V_{CTRL} = 1.5\text{V}$, $V_{IN} = 2.7\text{V}$ to 6V, $T_A = +25^\circ\text{C}$	0.295	0.300	0.305	V	
FBA, FBB Input Bias Current	V_{FBA} or $V_{FBB} =$ $V_{CTRL} / 5$	$T_A = +25^\circ\text{C}$	0.01	1	μA	
		$T_A = +85^\circ\text{C}$	0.2			
CTRL Input Resistance	$V_{CTRL} \leq 1.0\text{V}$, $T_A = -40^\circ\text{C}$ to start of T_A derating function	290	500	780	k Ω	
Derating Function Start Temperature	MAX8608Y, $V_{CTRL} = 3.0\text{V}$, ENA = IN		+40		$^\circ\text{C}$	
Derating Function Slope	MAX8608Y, $V_{CTRL} = 3.0\text{V}$, ENA = IN, $T_A =$ start of T_A derating to $+85^\circ\text{C}$		-5.8		mV/ $^\circ\text{C}$	

High-Efficiency, 26V Step-Up Converters for Main and Subdisplays Using OLEDs and/or White LEDs

MAX8608Y/MAX8608Z

ELECTRICAL CHARACTERISTICS (continued)

($V_{IN} = 3.0V$, $V_{OVP} = 20V$, $L1 = 22\mu H$, $C_{OVP} = 1\mu F$, $C_{COMP} = 0.01\mu F$, $R_{COMP} = 10k\Omega$, $R_{SENSE} = 13\Omega$, $V_{CTRL} = 1.6V$, $T_A = -40^\circ C$ to $+85^\circ C$, unless otherwise noted. Typical values are at $T_A = +25^\circ C$.) (Note 1)

PARAMETER	CONDITIONS		MIN	TYP	MAX	UNITS
FB_ Maximum Voltage Clamp	$V_{CTRL} = 3V$	MAX8608Z	310	327	345	mV
		MAX8608Y, ENA = GND, ENB = IN	310	327	345	
		MAX8608Y, ENA = IN, $T_A \leq +25^\circ C$	322	340	358	
FBA, FBB to COMP Transconductance	$V_{COMP} = 1.5V$, $T_A = -40^\circ C$ to start of derating function		30	60	90	μS
COMP Input Resistance to GND	In shutdown or overvoltage lockout			20		$k\Omega$
OSCILLATOR						
Operating Frequency	FSEL = GND		0.77	1.0	1.25	MHz
	FSEL = IN		385	500	660	kHz
Maximum Duty Cycle	CTRL = IN, FBA = FBB = GND		92	96		%
Minimum Duty Cycle	In regulation at light loads			14		%
LX, OUTA, OUTB SWITCHES						
LX On-Resistance				1.2	2.4	Ω
LX Leakage Current	$V_{LX} = 28V$, CTRL = GND	$T_A = +25^\circ C$		0.01	1	μA
		$T_A = +85^\circ C$		1		
LX Current Limit	Duty cycle = 90%, $T_A = -40^\circ C$ to $+85^\circ C$		500	700	900	mA
OUTA and OUTB Switch On-Resistance				7	14	Ω
OUTA and OUTB Current Limit			150	300	450	mA
OUTA Off-Leakage	ENA = GND, ENB = IN, $V_{OVP} = 25V$, $V_{OUTA} = 0V$	$T_A = +25^\circ C$		0.01	1	μA
		$T_A = +85^\circ C$		1		
OUTB Off-Leakage	ENA = IN, ENB = GND, $V_{OVP} = 25V$, $V_{OUTB} = 0V$	$T_A = +25^\circ C$		0.01	1	μA
		$T_A = +85^\circ C$		1		
OVP Cap Discharge Time	FSEL = GND			8		ms
	FSEL = IN			16		

Note 1: All devices are 100% production tested at $T_A = +25^\circ C$. Specifications over the operating temperature range are guaranteed by design and characterization.

Note 2: V_{D1} is the diode forward-voltage drop of diode D1 in Figure 1.

High-Efficiency, 26V Step-Up Converters for Main and Subdisplays Using OLEDs and/or White LEDs

Typical Operating Characteristics

(Circuit of Figure 1, $V_{IN} = 3.6V$, $I_{LED} = 20mA$, $L_1 = 22\mu H$, $C_{OVLP} = 1\mu F$, $C_{COMP} = 0.01\mu F$, $R_{SENSE} = 13\Omega$, $V_{CTRL} = 1.5V$, 4 LEDs, $T_A = +25^\circ C$, unless otherwise noted.)

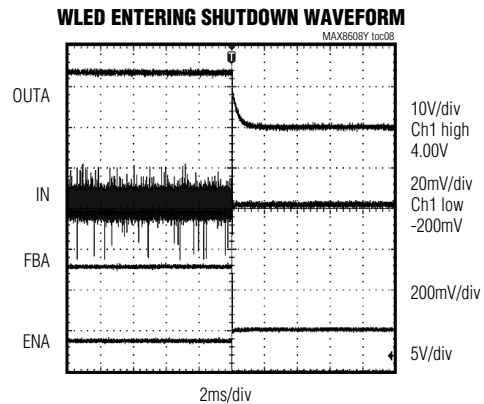
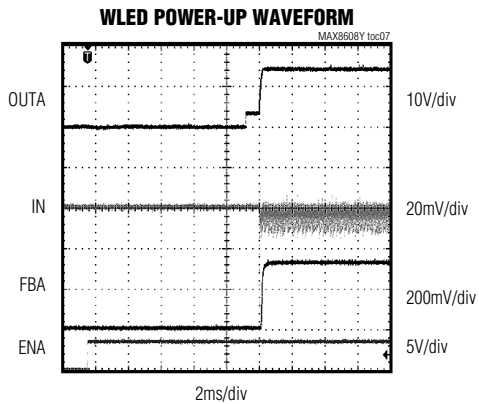
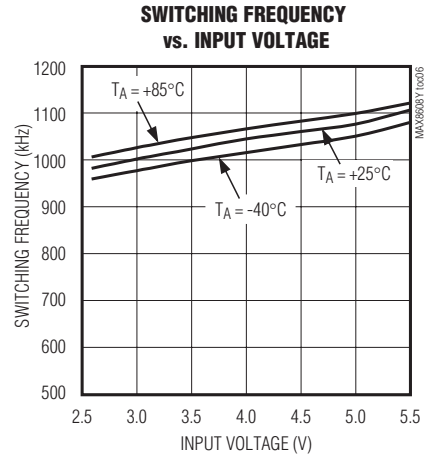
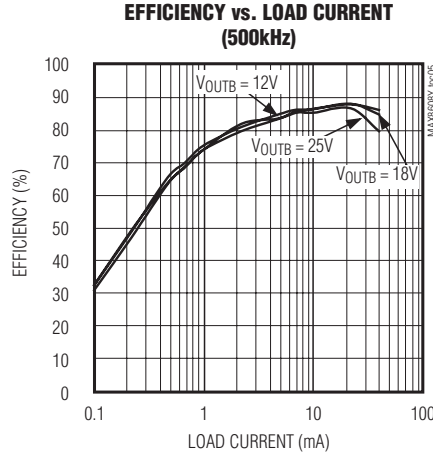
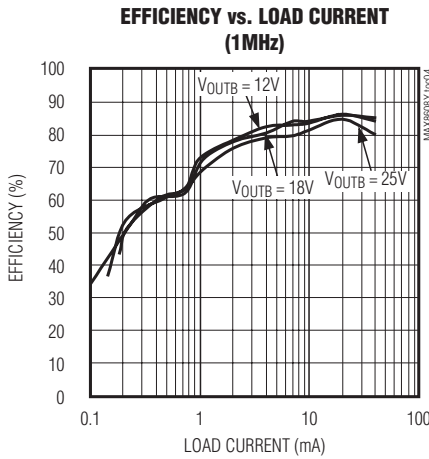
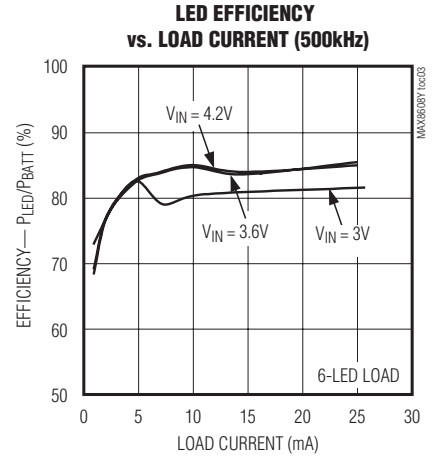
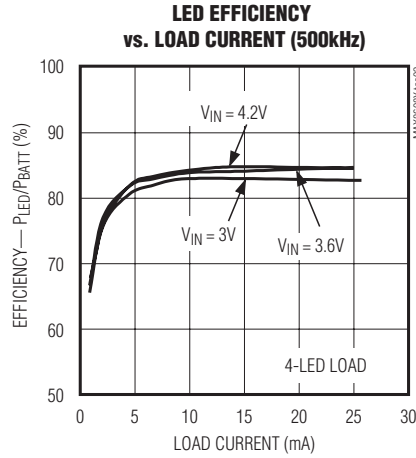
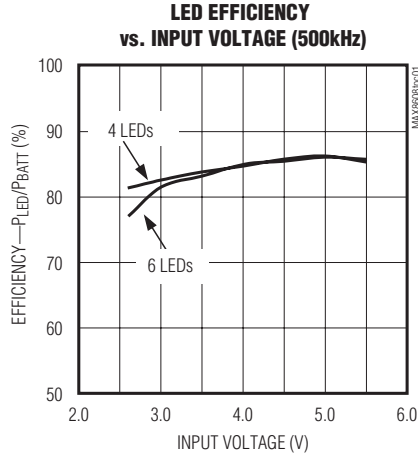

High-Efficiency, 26V Step-Up Converters for Main and Subdisplays Using OLEDs and/or White LEDs

Typical Operating Characteristics (continued)

(Circuit of Figure 1, $V_{IN} = 3.6V$, $I_{LED} = 20mA$, $L_1 = 22\mu H$, $C_{OVP} = 1\mu F$, $C_{COMP} = 0.01\mu F$, $R_{SENSE} = 13\Omega$, $V_{CTRL} = 1.5V$, 4 LEDs, $T_A = +25^\circ C$, unless otherwise noted.)

MAX8608Y/MAX8608Z

OLED POWER-UP WAVEFORMS

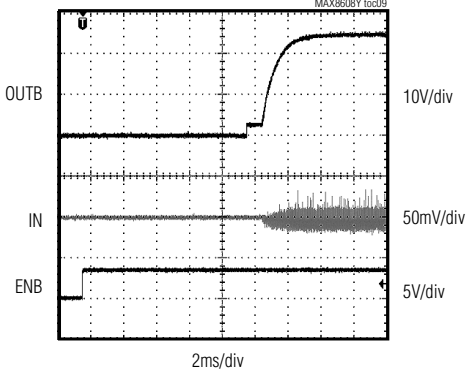

OLED SHUTDOWN WAVEFORMS

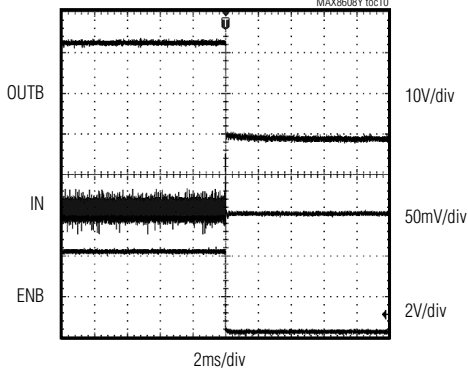

SWITCHING WAVEFORMS

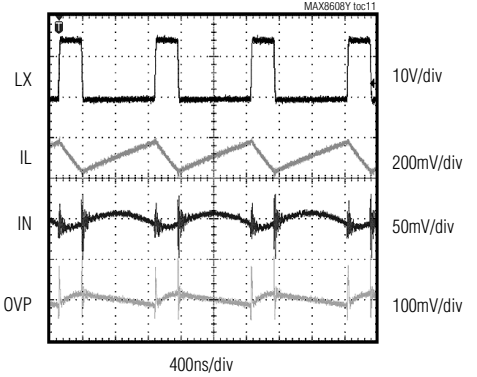

LINE TRANSIENT

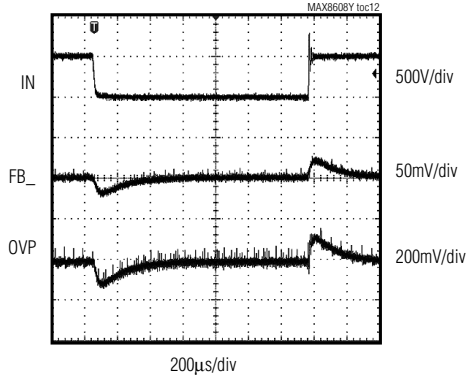

WLED VCTRL STEP RESPONSE

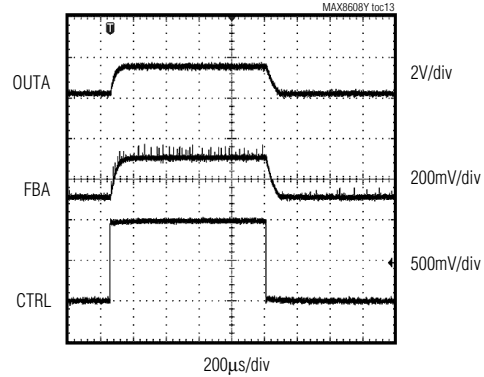

OLED VCTRL STEP RESPONSE

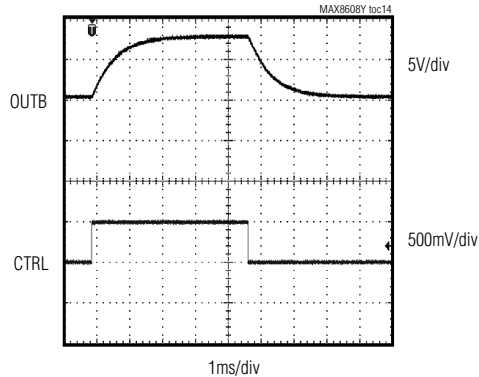

OLED LOAD TRANSIENT RESPONSE

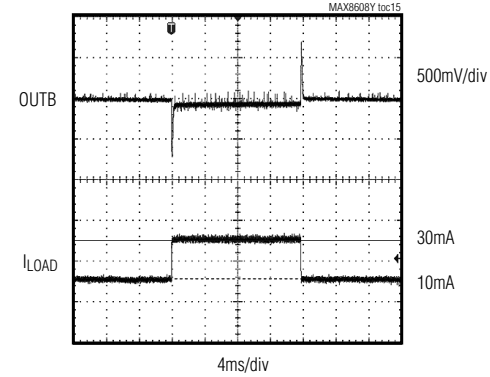

High-Efficiency, 26V Step-Up Converters for Main and Subdisplays Using OLEDs and/or White LEDs

Pin Description

PIN	NAME	FUNCTION
1	IN	Input Voltage Supply. Connect a 2.2 μ F capacitor from IN to PGND.
2	PGND	Power Ground. Connect to the exposed paddle directly underneath the IC.
3	FSEL	Frequency Select Input. Drive FSEL low or connect to GND for a 1MHz operating frequency. Drive FSEL high or connect to IN for a 500kHz operating frequency.
4	ENA	OUTA Enable Input. Drive ENA high to turn on OUTA. Drive ENA low to turn off OUTA. When ENA is high, it overrides ENB and shuts down OUTB regardless of the state of ENB. When both ENA and ENB are low, the IC enters low-power shutdown.
5	ENB	OUTB Enable Input. When ENA is low, drive ENB high to turn on OUTB or drive ENB low to turn off OUTB. If ENA is high, ENB is a “don’t care” and OUTB is off. When both ENA and ENB are low, the IC enters low-power shutdown.
6	CTRL	Control Input. The voltage applied to CTRL controls the WLED output current or the OLED output voltage. Varying the CTRL voltage from 0 to 1.65V adjusts the output current (or voltage) from low to high, respectively. Any voltage above 1.65V does not increase the output.
7	GND	Ground. Connect to the exposed paddle directly underneath the IC.
8	COMP	Compensation Input. Connect a 0.01 μ F capacitor (C_{COMP}) and a 10k Ω resistor (R_{COMP}) in series from COMP to GND. These components stabilize the converter and control soft-start. COMP internally connects to GND when in shutdown or overvoltage-protection mode.
9	FBB	Feedback Input for OUTB. Connect a resistor from FBB to GND to set the LED bias current. The voltage at FBB regulates to $V_{CTRL} / 5$ or 0.33V, whichever is lower. For voltage-feedback operation, connect FBB to the center of a resistor-divider connected between OUTB and GND.
10	FBA	Feedback Input for OUTA. Connect a resistor from FBA to GND to set the LED bias current. The voltage at FBA regulates to $V_{CTRL} / 5$ or 0.33V, whichever is lower. For voltage-feedback operation, connect FBA to the center of a resistor-divider connected between OUTA and GND.
11	OUTB	Output of Regulator B. When ENB is high, OVP is internally connected to OUTB through a 7 Ω MOSFET. OUTB is high impedance when ENB is low. OUTB is high impedance if ENA is high, regardless of the state of ENB.
12	OVP	Overvoltage Sense and Boost Output. When V_{OVP} is greater than 27V, the internal n-channel MOSFET turns off until V_{OVP} drops below 25V, then the IC reenters soft-start. Connect a 1 μ F capacitor from OVP to PGND.
13	OUTA	When ENA is high, OVP is internally connected to OUTA through a 7 Ω MOSFET. OUTA is high impedance when ENA is low.
14	LX	Inductor Connection. During shutdown, LX is high impedance.
—	EP	Exposed Paddle. Connect directly to GND and PGND underneath the IC.

High-Efficiency, 26V Step-Up Converters for Main and Subdisplays Using OLEDs and/or White LEDs

MAX8608Y/MAX8608Z

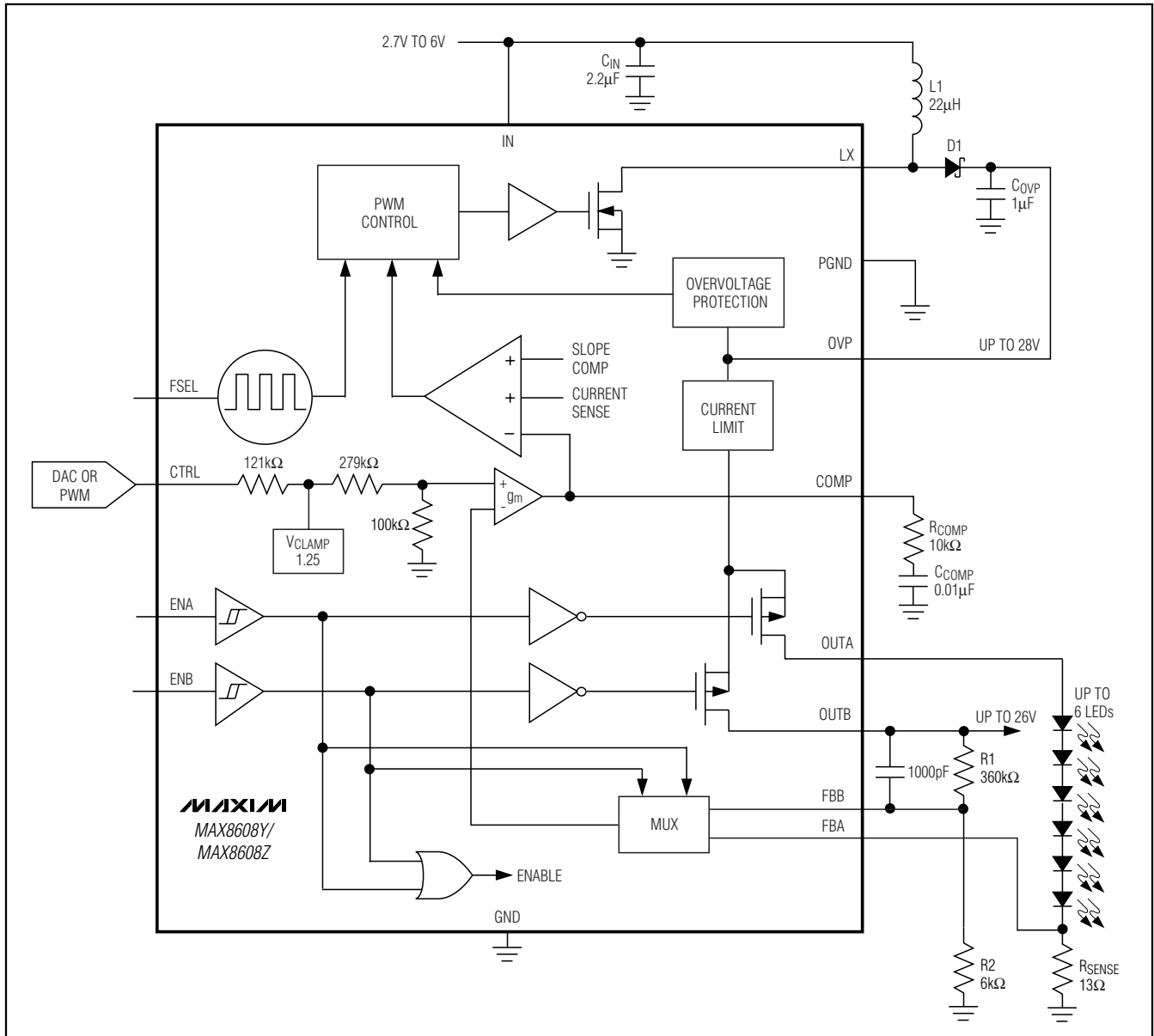

Figure 1. Functional Diagram and Typical Applications Circuit

Detailed Description

The MAX8608's high efficiency and small size make it ideally suited to drive any combination of OLED and/or WLEDs in dual-display cell phones. It operates as a PWM boost DC-DC converter with two internal load switches to power two independent displays. Each output can be configured for current or voltage regulation.

The feedback input regulates at $V_{CTRL} / 5$ or 330mV (max), whichever is lower. In current regulation, the MAX8608 provides even illumination by sourcing the same output current through each LED, eliminating the need for expensive factory calibration. The MAX8608 can also function as a voltage supply by connecting a voltage-divider from either OUTA or OUTB to its corresponding feedback input.

High-Efficiency, 26V Step-Up Converters for Main and Subdisplays Using OLEDs and/or White LEDs

Table 1. Truth Table for the Enable Inputs

ENA	ENB	OUTA	OUTB	BOOST BIAS
0	0	Hi-Z	Hi-Z	OFF
0	1	Hi-Z	ON	ON
1	0	ON	Hi-Z	ON
1	1	ON	Hi-Z	ON

The fast 1MHz internal oscillator allows for a small inductor and small input and output capacitors while minimizing input and output ripple. For higher efficiency at the expense of larger components, a logic input may select 500kHz operation. At light loads, the MAX8608 operates in PFM mode to maximize efficiency. A soft-start gradually illuminates the LEDs, reducing the inrush current during startup.

The single analog control input allows easy adjustment of WLED current or OLED voltage. The control input is internally filtered to allow for either simple analog voltage control or direct-PWM duty-cycle control while maintaining low input/output ripple. In shutdown, supply current is reduced to a low 0.01μA.

Enable and Output Control

The MAX8608's outputs are enabled by the ENA and ENB inputs, which also turn on and off the part's internal bias circuitry. ENA is the dominant input. Table 1 shows the truth table for these inputs.

Each output is protected against short circuit to ground by an internal current limit (300mA typ). If an output becomes current limited, the corresponding output switch turns off, the CCOMP is discharged to ground, and the soft-start sequence is reinitiated.

Soft-Start

The MAX8608 attains soft-start by charging CCOMP gradually with a current source. When VCOMP rises above 1.5V, the internal MOSFET begins switching, but at a reduced duty cycle. When VCOMP rises above 2.25V, the duty cycle is at its maximum. See the *Typical Operating Characteristics* for examples of soft-start operation with WLED and OLED loads.

Shutdown

The MAX8608 enters shutdown when ENA and ENB are low. In shutdown, supply current is reduced to 0.01μA by powering down the entire IC. CCOMP is discharged during shutdown, allowing the device to reinitiate soft-start when the device is enabled. Also, the internal switches from OVP to OUTA and OUTB are turned off so no current can pass to the loads.

Overvoltage Protection

Overvoltage lockout (OVLO) occurs when VOVP is above 27V (typ). The protection circuitry stops the internal MOSFET from switching and causes VCOMP to decay to GND. The device comes out of OVLO and into soft-start when VOUT falls below 25V (typ).

Ambient Temperature Derating Function (MAX8608Y Only)

The MAX8608Y limits the maximum LED current of OUTA depending on the die temperature. VFBA is limited to 340mV up to +40°C. Once the temperature reaches +40°C, the maximum VFBA declines by 5.8mV/°C. Due to the package's exposed paddle, the die temperature is always very close to the PC board temperature.

The temperature derating function matches the characteristic in popular WLED data sheets and allows the LED current to be safely set higher (25mA typ) at normal operating temperatures, thereby allowing either a brighter display or fewer LEDs to be used for normal display brightness.

Design Procedure

Adjusting WLED Current

Adjusting the MAX8608's output current changes the brightness of the LEDs. An analog input (CTRL) and the sense resistor value sets the output current. Output current is given by:

$$I_{LED} = \frac{V_{CTRL}}{5 \times R_{SENSE}}$$

The VCTRL voltage range for adjusting output current is 0 to 1.65V. To set the maximum current, calculate RSENSE when VCTRL is at its maximum as follows:

$$R_{SENSE} = \frac{1.65}{5 \times I_{LED(MAX)}}$$

Power dissipation in RSENSE is typically less than 10mW; therefore, a standard chip resistor is sufficient.

High-Efficiency, 26V Step-Up Converters for Main and Subdisplays Using OLEDs and/or White LEDs

Adjusting OLED Bias Output Voltage

Adjusting the MAX8608's output voltage changes the OLED bias headroom. An analog input (CTRL) and a resistor voltage-divider set the output voltage. The regulation voltage at FB_ is given by:

$$V_{FB_} = V_{CTRL} / 5$$

The V_{CTRL} voltage range for adjusting output voltage is 0 to 1.65V. Applying V_{CTRL} voltage above 1.65V does not increase the output voltage any further. To set the maximum output voltage, choose a value for R2 (Figure 1) between 1k Ω and 10k Ω and then calculate R1 when V_{CTRL} is at its maximum as follows:

$$R1 = R2 ((V_{OUT} / 0.33) - 1)$$

For loop stability and good transient response, place a feed-forward capacitor (1000pF typ) in parallel with R1. The feed-forward capacitor value is not critical. Calculate the approximate value as:

$$C_{FF} \cong \frac{5e^{-6}}{R2}$$

PWM Dimming Control

When both OUT1/FB1 and OUT2/FB2 are configured for current regulation for WLED loads, CTRL can also be used as a digital input, allowing LED brightness control with a logic level (greater than 1.65V) PWM signal applied directly to CTRL. Use a 200Hz to 200kHz frequency range. A 0% duty cycle corresponds to full current. The error amplifier and compensation network form a lowpass filter such that PWM dimming results in DC current to the LEDs without the need for any additional RC filters. For this to work correctly, change the compensation network to a 0.1 μ F capacitor from COMP to GND (with $R_{COMP} = 0\Omega$).

Capacitor Selection

The exact values of input and output capacitors are not critical. The typical value for the input capacitor is 2.2 μ F, and the typical value for the output capacitor is 1 μ F. Larger-value capacitors can be used to reduce input and output ripple, but at the expense of size and higher cost. C_{COMP} stabilized the converter and controls soft-start. Connect a 10k Ω resistor and 0.01 μ F capacitor in series from COMP to GND. For applications with both outputs configured for WLED current regulation, change the compensation network to a 0.1 μ F capacitor from COMP to GND (with $R_{COMP} = 0\Omega$).

Inductor Selection

Inductor values range from 10 μ H to 47 μ H. When using 1MHz operation, a 22 μ H inductor optimizes the efficiency for most applications. When using 500kHz operation, a 47 μ H inductor optimizes the efficiency for most applications. With input voltages near 5V, a larger value of inductance may be more efficient. To prevent core saturation, ensure that the inductor saturation current rating exceeds the peak inductor current for the application. Calculate the peak inductor current for 1MHz switching with the following formula:

$$I_{PEAK} = \frac{V_{OUT_MAX} \times I_{LED_MAX}}{0.8 \times V_{IN_MIN}} + \frac{V_{IN_MIN} \times 0.8\mu s}{2 \times L}$$

Schottky Diode Selection

The MAX8608's high switching frequency demands a high-speed rectification diode (D1) for optimum efficiency. A Schottky diode is recommended due to its fast recovery time and low forward-voltage drop. Ensure that the diode's average and peak current rating exceed the average output current and peak inductor current. In addition, the diode's reverse breakdown voltage must exceed V_{OVP} . The RMS diode current can be calculated from:

$$I_{DIODE(RMS)} \cong \sqrt{I_{OUT_} \times I_{PEAK}}$$

Applications Information

PC Board Layout

Due to fast-switching waveforms and high current paths, careful PC board layout is required. An evaluation kit (MAX8608YEVKIT) is available to aid design.

When laying out a board, minimize trace lengths between the IC and R_{SENSE} (and/or feedback resistors), the inductor, the diode, the input capacitor, and the output capacitor. Keep traces short, direct, and wide. Keep noisy traces, such as the LX node trace, away from FBA and FBB. The IN bypass capacitor (C_{IN}) should be placed as close to the IC as possible. PGND and GND should be connected directly to the exposed paddle underneath the IC. The ground connections of C_{IN} and C_{OVP} should be as close together as possible. The traces from IN to the inductor and from the Schottky diode to the LEDs may be longer.

High-Efficiency, 26V Step-Up Converters for Main and Subdisplays Using OLEDs and/or White LEDs

Typical Operating Circuit

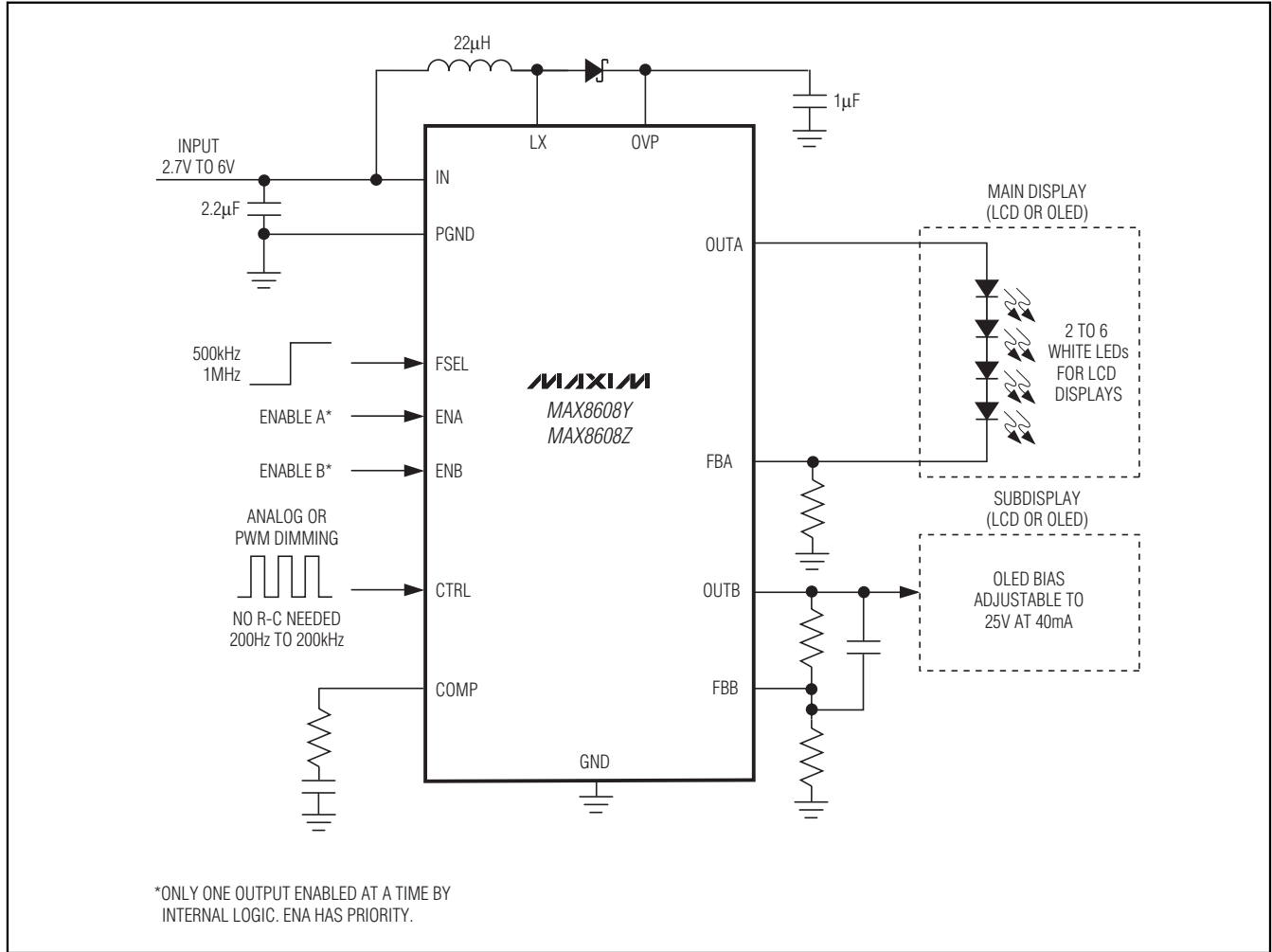

Chip Information

PROCESS: BiCMOS

High-Efficiency, 26V Step-Up Converters for Main and Subdisplays Using OLEDs and/or White LEDs

Package Information

(The package drawing(s) in this data sheet may not reflect the most current specifications. For the latest package outline information, go to www.maxim-ic.com/packages.)

MAX8608Y/MAX8608Z

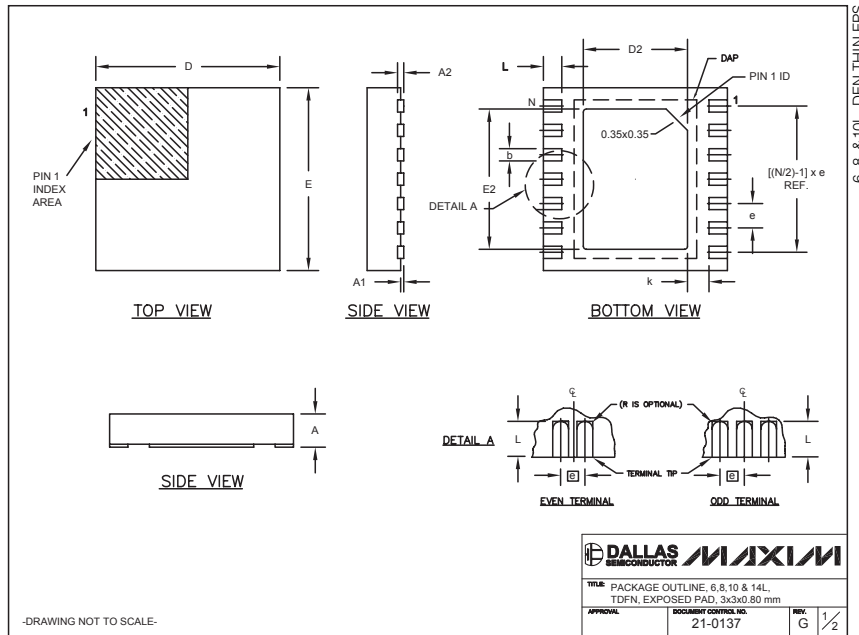

COMMON DIMENSIONS							
SYMBOL	MIN.	MAX.					
A	0.70	0.80					
D	2.90	3.10					
E	2.90	3.10					
A1	0.00	0.05					
L	0.20	0.40					
k	0.25 MIN.						
A2	0.20 REF.						

PACKAGE VARIATIONS								
PKG. CODE	N	D2	E2	e	JEDEC SPEC	b	[(N/2)-1] x e	DOWNBONDS ALLOWED
T633-1	6	1.50±0.10	2.30±0.10	0.95 BSC	MO229 / WEEA	0.40±0.05	1.90 REF	NO
T633-2	6	1.50±0.10	2.30±0.10	0.95 BSC	MO229 / WEEA	0.40±0.05	1.90 REF	NO
T833-1	8	1.50±0.10	2.30±0.10	0.65 BSC	MO229 / WEEC	0.30±0.05	1.95 REF	NO
T833-2	8	1.50±0.10	2.30±0.10	0.65 BSC	MO229 / WEEC	0.30±0.05	1.95 REF	NO
T833-3	8	1.50±0.10	2.30±0.10	0.65 BSC	MO229 / WEEC	0.30±0.05	1.95 REF	YES
T1033-1	10	1.50±0.10	2.30±0.10	0.50 BSC	MO229 / WEEED-3	0.25±0.05	2.00 REF	NO
T1433-1	14	1.70±0.10	2.30±0.10	0.40 BSC	----	0.20±0.05	2.40 REF	YES
T1433-2	14	1.70±0.10	2.30±0.10	0.40 BSC	----	0.20±0.05	2.40 REF	NO

NOTES:
 1. ALL DIMENSIONS ARE IN mm. ANGLES IN DEGREES.
 2. COPLANARITY SHALL NOT EXCEED 0.08 mm.
 3. WARPAGE SHALL NOT EXCEED 0.10 mm.
 4. PACKAGE LENGTH/PACKAGE WIDTH ARE CONSIDERED AS SPECIAL CHARACTERISTIC(S).
 5. DRAWING CONFORMS TO JEDEC MO229, EXCEPT DIMENSIONS "D2" AND "E2", AND T1433-1 & T1433-2.
 6. "N" IS THE TOTAL NUMBER OF LEADS.
 7. NUMBER OF LEADS SHOWN ARE FOR REFERENCE ONLY.

-DRAWING NOT TO SCALE-

APPROVAL	DOCUMENT CONTROL NO.	REV.	2/2
	21-0137	G	

Maxim cannot assume responsibility for use of any circuitry other than circuitry entirely embodied in a Maxim product. No circuit patent licenses are implied. Maxim reserves the right to change the circuitry and specifications without notice at any time.

Maxim Integrated Products, 120 San Gabriel Drive, Sunnyvale, CA 94086 408-737-7600 11