

# MUR220

Preferred Device

## SWITCHMODE™ Power Rectifier

These state-of-the-art devices are designed for use in switching power supplies, inverters and as free wheeling diodes.

### Features

- Ultrafast 25 Nanosecond Recovery Times
- 175°C Operating Junction Temperature
- Low Forward Voltage
- Low Leakage Current
- High Temperature Glass Passivated Junction
- These are Pb-Free Devices\*

### Mechanical Characteristics:

- Case: Epoxy, Molded
- Weight: 0.4 Gram (Approximately)
- Finish: All External Surfaces Corrosion Resistant and Terminal Leads are Readily Solderable
- Lead Temperature for Soldering Purposes: 260°C Max. for 10 Seconds
- Polarity: Cathode Indicated by Polarity Band

### MAXIMUM RATINGS

Rating	Symbol	Value	Unit
Peak Repetitive Reverse Voltage Working Peak Reverse Voltage DC Blocking Voltage	$V_{RRM}$ $V_{RWM}$ $V_R$	200 –	V
Average Rectified Forward Current (Note 1) (Square Wave Mounting Method #3 Per Note 3)	$I_{F(AV)}$	2.0 @ $T_A = 90^\circ\text{C}$	A
Non-Repetitive Peak Surge Current (Surge applied at rated load conditions, halfwave, single phase, 60 Hz)	$I_{FSM}$	35	A
Operating Junction Temperature and Storage Temperature Range	$T_J, T_{stg}$	– 65 to +175	°C

### THERMAL CHARACTERISTICS

Characteristic	Symbol	Max	Unit
Thermal Resistance, Junction-to-Ambient	$R_{\theta JA}$	(Note 3)	°C/W

Stresses exceeding Maximum Ratings may damage the device. Maximum Ratings are stress ratings only. Functional operation above the Recommended Operating Conditions is not implied. Extended exposure to stresses above the Recommended Operating Conditions may affect device reliability.

1. Pulse Test: Pulse Width = 300  $\mu\text{s}$ , Duty Cycle  $\leq 2.0\%$ .

\*For additional information on our Pb-Free strategy and soldering details, please download the ON Semiconductor Soldering and Mounting Techniques Reference Manual, SOLDERRM/D.



ON Semiconductor®

<http://onsemi.com>

## ULTRAFAST RECTIFIER 2.0 AMPERES – 200 VOLTS

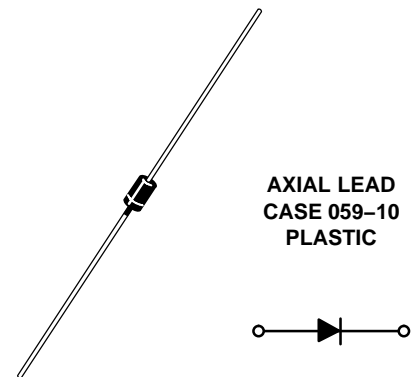

### MARKING DIAGRAM



A = Assembly Location  
MUR220 = Device Code  
YY = Year  
WW = Work Week  
▪ = Pb-Free Package

(Note: Microdot may be in either location)

### ORDERING INFORMATION

Device	Package	Shipping†
MUR220	Axial Lead**	1000 Units / Bulk
MUR220G	Axial Lead**	1000 Units / Bulk
MUR220RL	Axial Lead**	5000 / Tape & Reel
MUR220RLG	Axial Lead**	5000 / Tape & Reel

†For information on tape and reel specifications, including part orientation and tape sizes, please refer to our Tape and Reel Packaging Specifications Brochure, BRD8011/D.

\*\*This package is inherently Pb-Free.

Preferred devices are recommended choices for future use and best overall value.

# MUR220

## ELECTRICAL CHARACTERISTICS

Characteristic	Symbol	Value	Unit
Maximum Instantaneous Forward Voltage (Note 2) ( $I_F = 2.0$ Amp, $T_J = 150^\circ\text{C}$ ) ( $I_F = 2.0$ Amp, $T_J = 25^\circ\text{C}$ )	$V_F$	0.75 0.95	V
Maximum Instantaneous Reverse Current (Note 2) (Rated dc Voltage, $T_J = 150^\circ\text{C}$ ) (Rated dc Voltage, $T_J = 25^\circ\text{C}$ )	$i_R$	50 2.0	$\mu\text{A}$
Maximum Reverse Recovery Time ( $I_F = 1.0$ Amp, $di/dt = 50$ Amp/ $\mu\text{s}$ ) ( $I_F = 0.5$ Amp, $I_R = 1.0$ Amp, $I_{REC} = 0.25$ A)	$t_{rr}$	35 25	ns
Maximum Forward Recovery Time ( $I_F = 1.0$ A, $di/dt = 100$ A/ $\mu\text{s}$ , $I_{REC}$ to 1.0 V)	$t_{fr}$	25	ns

2. Pulse Test: Pulse Width = 300  $\mu\text{s}$ , Duty Cycle  $\leq 2.0\%$ .

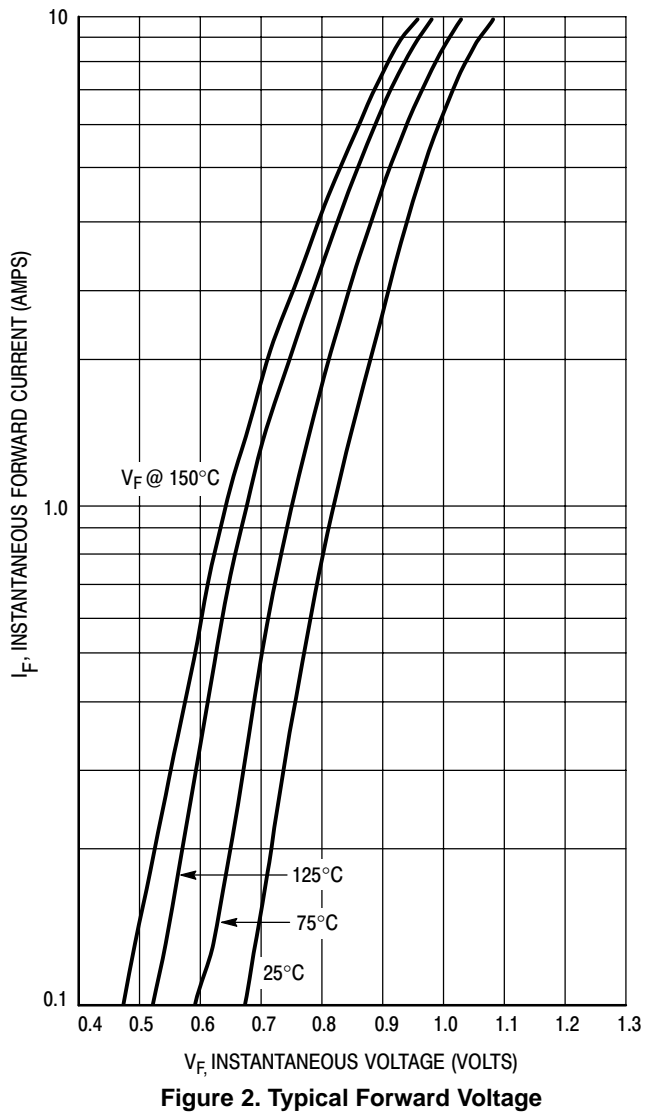
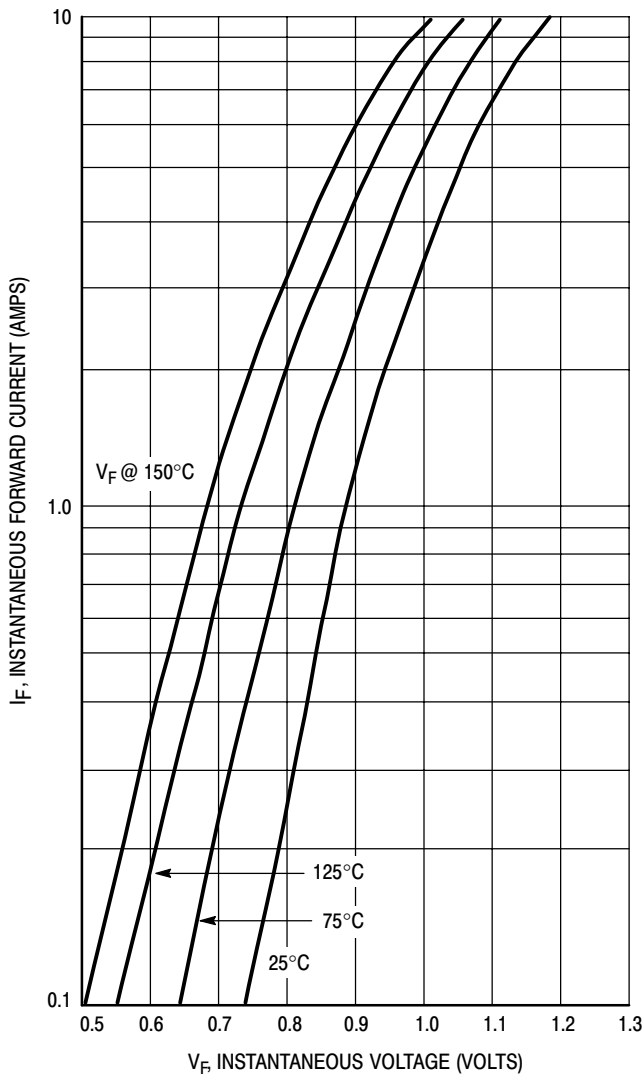

# MUR220

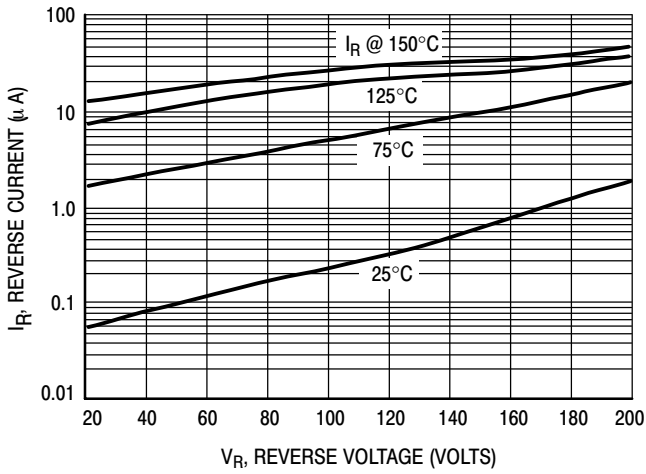

**Figure 3. Maximum Reverse Current**

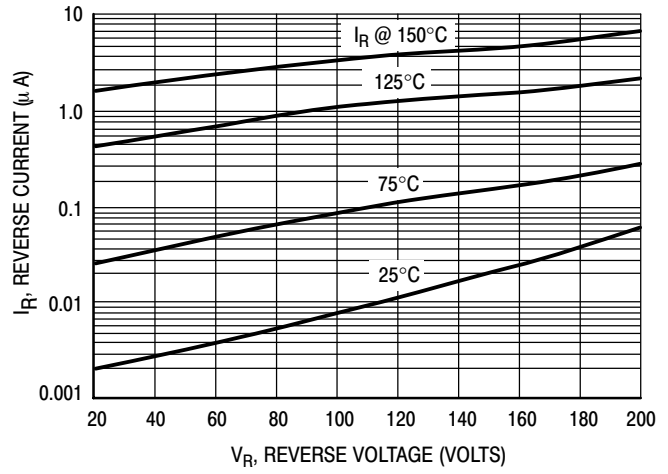

**Figure 4. Typical Reverse Current**

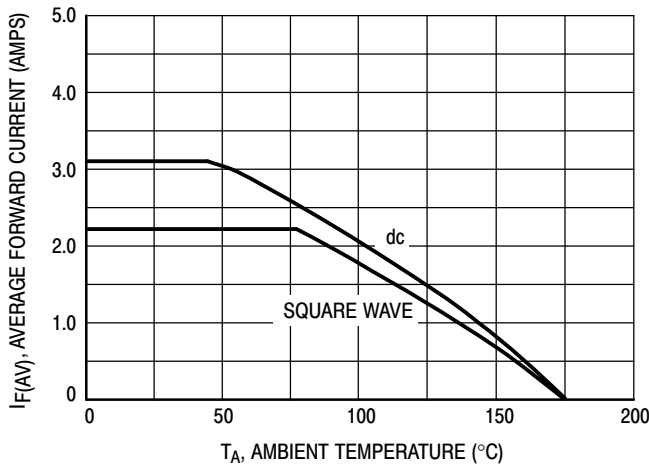

**Figure 5. Current Derating**

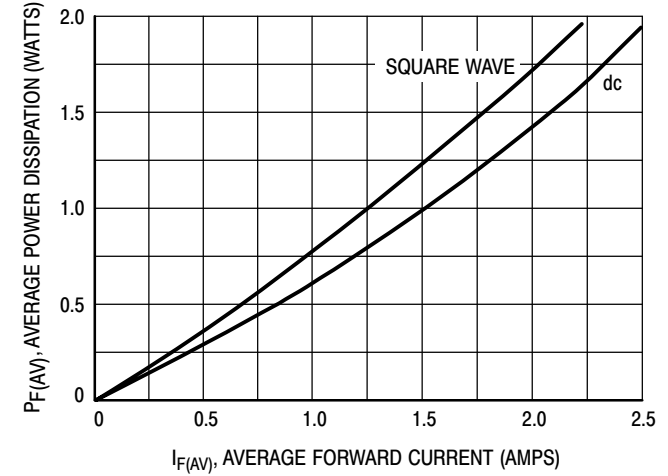

**Figure 6. Power Dissipation**

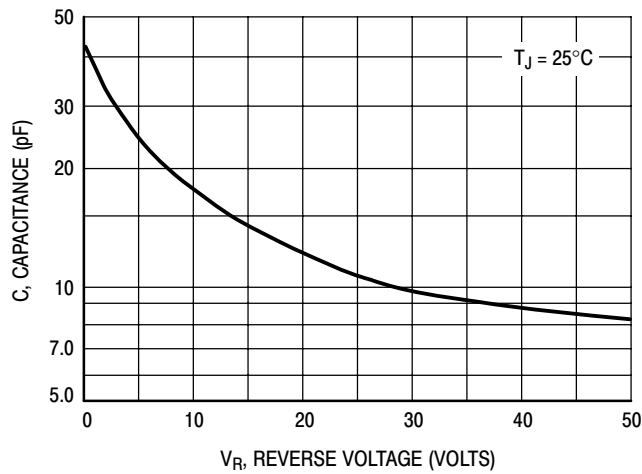

**Figure 7. Typical Capacitance**

# MUR220

## NOTE 3. – AMBIENT MOUNTING DATA

Data shown for Thermal Resistance, Junction-to-Ambient ( $R_{\theta JA}$ ) for the mountings shown is to be used as typical guideline values for preliminary engineering or in case the tie point temperature cannot be measured.

### TYPICAL VALUES FOR $R_{\theta JA}$ IN STILL AIR

Mounting Method	$R_{\theta JA}$	Lead Length, L			Units
		1/8	1/4	1/2	
1		52	65	72	$^{\circ}\text{C/W}$
2		67	80	87	$^{\circ}\text{C/W}$
3		50			$^{\circ}\text{C/W}$

#### MOUNTING METHOD 1

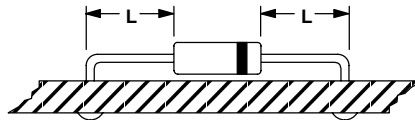

#### MOUNTING METHOD 2

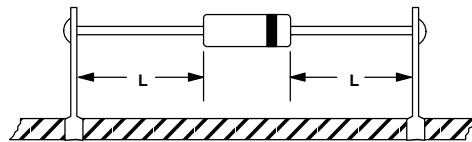

#### Vector Pin Mounting

#### MOUNTING METHOD 3

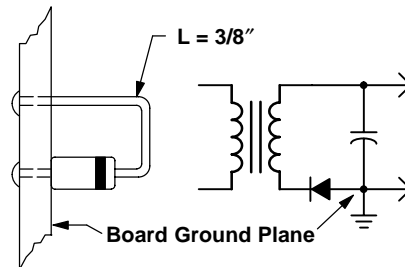

#### P.C. Board with 1-1/2" X 1-1/2" Copper Surface

# MECHANICAL CASE OUTLINE

## PACKAGE DIMENSIONS

ON Semiconductor®



### AXIAL LEAD CASE 59-10 ISSUE U

DATE 15 FEB 2005

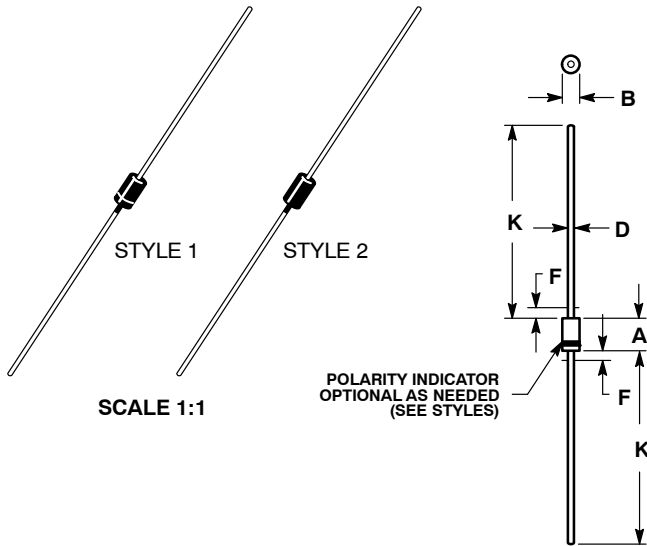

STYLE 1

STYLE 2

SCALE 1:1

POLARITY INDICATOR  
OPTIONAL AS NEEDED  
(SEE STYLES)

NOTES:

1. DIMENSIONING AND TOLERANCING PER ANSI Y14.5M, 1982.
2. CONTROLLING DIMENSION: INCH.
3. ALL RULES AND NOTES ASSOCIATED WITH JEDEC DO-41 OUTLINE SHALL APPLY.
4. POLARITY DENOTED BY CATHODE BAND.
5. LEAD DIAMETER NOT CONTROLLED WITHIN F DIMENSION.

DIM	INCHES		MILLIMETERS	
	MIN	MAX	MIN	MAX
A	0.161	0.205	4.10	5.20
B	0.079	0.106	2.00	2.70
D	0.028	0.034	0.71	0.86
F	---	0.050	---	1.27
K	1.000	---	25.40	---

### GENERIC MARKING DIAGRAM\*

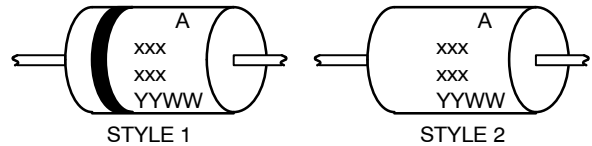

STYLE 1:  
PIN 1. CATHODE (POLARITY BAND)  
2. ANODE

STYLE 2:  
NO POLARITY

- xxx = Specific Device Code
- A = Assembly Location
- YY = Year
- WW = Work Week

\*This information is generic. Please refer to device data sheet for actual part marking.  
Pb-Free indicator, "G" or microdot "▪", may or may not be present.

<b>DOCUMENT NUMBER:</b>	<b>98ASB42045B</b>	Electronic versions are uncontrolled except when accessed directly from the Document Repository. Printed versions are uncontrolled except when stamped "CONTROLLED COPY" in red.
<b>DESCRIPTION:</b>	<b>AXIAL LEAD</b>	<b>PAGE 1 OF 1</b>

ON Semiconductor and are trademarks of Semiconductor Components Industries, LLC dba ON Semiconductor or its subsidiaries in the United States and/or other countries. ON Semiconductor reserves the right to make changes without further notice to any products herein. ON Semiconductor makes no warranty, representation or guarantee regarding the suitability of its products for any particular purpose, nor does ON Semiconductor assume any liability arising out of the application or use of any product or circuit, and specifically disclaims any and all liability, including without limitation special, consequential or incidental damages. ON Semiconductor does not convey any license under its patent rights nor the rights of others.

**onsemi**, **Onsemi**, and other names, marks, and brands are registered and/or common law trademarks of Semiconductor Components Industries, LLC dba "**onsemi**" or its affiliates and/or subsidiaries in the United States and/or other countries. **onsemi** owns the rights to a number of patents, trademarks, copyrights, trade secrets, and other intellectual property. A listing of **onsemi**'s product/patent coverage may be accessed at [www.onsemi.com/site/pdf/Patent-Marking.pdf](http://www.onsemi.com/site/pdf/Patent-Marking.pdf). **onsemi** reserves the right to make changes at any time to any products or information herein, without notice. The information herein is provided "as-is" and **onsemi** makes no warranty, representation or guarantee regarding the accuracy of the information, product features, availability, functionality, or suitability of its products for any particular purpose, nor does **onsemi** assume any liability arising out of the application or use of any product or circuit, and specifically disclaims any and all liability, including without limitation special, consequential or incidental damages. Buyer is responsible for its products and applications using **onsemi** products, including compliance with all laws, regulations and safety requirements or standards, regardless of any support or applications information provided by **onsemi**. "Typical" parameters which may be provided in **onsemi** data sheets and/or specifications can and do vary in different applications and actual performance may vary over time. All operating parameters, including "Typicals" must be validated for each customer application by customer's technical experts. **onsemi** does not convey any license under any of its intellectual property rights nor the rights of others. **onsemi** products are not designed, intended, or authorized for use as a critical component in life support systems or any FDA Class 3 medical devices or medical devices with a same or similar classification in a foreign jurisdiction or any devices intended for implantation in the human body. Should Buyer purchase or use **onsemi** products for any such unintended or unauthorized application, Buyer shall indemnify and hold **onsemi** and its officers, employees, subsidiaries, affiliates, and distributors harmless against all claims, costs, damages, and expenses, and reasonable attorney fees arising out of, directly or indirectly, any claim of personal injury or death associated with such unintended or unauthorized use, even if such claim alleges that **onsemi** was negligent regarding the design or manufacture of the part. **onsemi** is an Equal Opportunity/Affirmative Action Employer. This literature is subject to all applicable copyright laws and is not for resale in any manner.

## PUBLICATION ORDERING INFORMATION

### LITERATURE FULFILLMENT:

Email Requests to: [orderlit@onsemi.com](mailto:orderlit@onsemi.com)

**onsemi Website:** [www.onsemi.com](http://www.onsemi.com)

### TECHNICAL SUPPORT

**North American Technical Support:**

Voice Mail: 1 800-282-9855 Toll Free USA/Canada

Phone: 011 421 33 790 2910

**Europe, Middle East and Africa Technical Support:**

Phone: 00421 33 790 2910

For additional information, please contact your local Sales Representative