

2.5A Synchronous Buck Regulator

Features

- 4.5V to 16.5V Input Voltage Range
- Dual Mode Operation for High Efficiency (up to 96%)
 - PWM Mode for > 200 mA Load Current
 - Skip Mode for < 200 mA Load Current
- 100 mΩ Internal Power MOSFETs at 12V Input
- 200 kHz Preset Switching Frequency
- Low Quiescent Current
 - 1.0 mA in PWM Mode
 - 500 μA in Skip Mode
 - < 5 μA in Shutdown Mode
- 100% Duty Cycle for Low Dropout Operation
- Current-Mode Control
 - Simplified Loop Compensation
 - Superior Line Regulation
- Current Limit
- Thermal Shutdown
- Undervoltage Lockout

Applications

- High-Efficiency, Battery-Powered Supplies
- Buck (Step-Down) DC-to-DC Converters
- Cellular Telephones
- Laptop Computers
- Handheld Instruments
- Battery Charger

General Description

The MIC2177 is a 200 kHz synchronous buck (step-down) switching regulator designed for high-efficiency, battery-powered applications.

The MIC2177 operates from a 4.5V to 16.5V input and features internal power MOSFETs that can supply up to 2.5A output current. It can operate with a maximum duty cycle of 100% for use in low-dropout conditions. It also features a shutdown mode that reduces quiescent current to less than 5 μA.

The MIC2177 achieves high efficiency over a wide output current range by switching between PWM and skip mode. Operating mode is automatically selected according to output conditions. Switching frequency is preset to 200 kHz and can be synchronized to an external clock signal of up to 300 kHz.

The MIC2177 uses current-mode control with internal current sensing. Current-mode control provides superior line regulation and makes the regulator control loop easy to compensate. The output is protected with pulse-by-pulse current limiting and thermal shutdown. Undervoltage lockout turns the output off when the input voltage is less than 4.5V.

The MIC2177 is packaged in a 20-pin wide power SOIC package with an operating temperature range of -40°C to +85°C.

Package Type

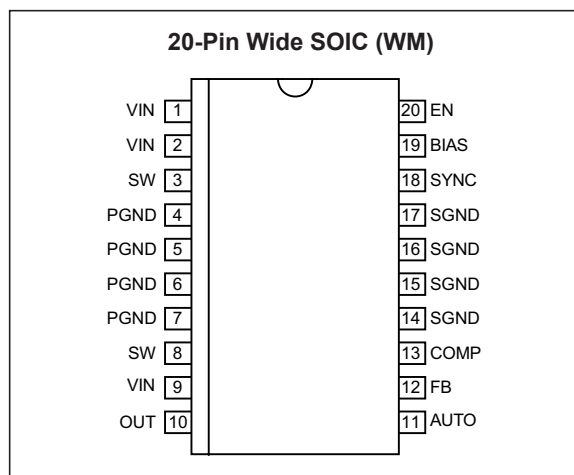

1.0 ELECTRICAL CHARACTERISTICS

Absolute Maximum Ratings †

Supply Voltage [100 ms Transient] (V_{IN}).....	+18V
Output Switch Voltage (V_{SW}).....	+18V
Output Switch Current (I_{SW}).....	+6.0A
Enable, Output Sense Voltage (V_{EN} , V_{OUT}).....	+18V
Sync Pin Voltage (V_{SYNC}).....	+6V

Operating Ratings ‡

Supply Voltage (V_{IN}).....	+4.5V to +16.5V
Junction Temperature (T_J).....	-40°C to +125°C

† **Notice:** Stresses above those listed under “Absolute Maximum Ratings” may cause permanent damage to the device. This is a stress rating only and functional operation of the device at those or any other conditions above those indicated in the operational sections of this specification is not intended. Exposure to maximum rating conditions for extended periods may affect device reliability. Specifications are for packaged product only.

‡ **Notice:** The device is not guaranteed to function outside its operating ratings.

ELECTRICAL CHARACTERISTICS

Electrical Characteristics: $V_{IN} = 7.0V$; $T_A = +25^\circ C$, **Bold** values indicate $-40^\circ C \leq T_A \leq +85^\circ C$; unless otherwise specified.

Parameter	Symbol	Min.	Typ.	Max.	Units	Conditions
Input Supply Current	I_{SS}	—	1.0	1.5	mA	PWM Mode, Output not Switching, $4.5V \leq V_{IN} \leq 16.5V$
		—	500	650	μA	Skip Mode, Output not Switching, $4.5V \leq V_{IN} \leq 16.5V$
		—	1	25	μA	$V_{EN} = 0V$, $4.5V \leq V_{IN} \leq 16.5V$
Bias Regulator Output Voltage	V_{BIAS}	3.10	3.30	3.40	V	$V_{IN} = 16.5V$
Feedback Voltage	V_{FB}	1.22	1.245	1.27	V	MIC2177 [Adj.]: $V_{OUT} = 3.3V$, $I_{LOAD} = 0$
Output Voltage	V_{OUT}	3.20	3.3	3.40	V	MIC2177 [Adj.]: $V_{OUT} = 3.3V$, $5V \leq V_{IN} \leq 16V$, $10 mA \leq I_{LOAD} \leq 2A$
		3.14		3.46	V	
		4.85	5.0	5.15	V	MIC2177-5.0: $I_{LOAD} = 0$
		4.85	5.0	5.15	V	MIC2177-5.0: $6V \leq V_{IN} \leq 16V$, $10 mA \leq I_{LOAD} \leq 2A$
		4.75		5.25	V	
3.20	3.3	3.40	V	MIC2177-3.3: $I_{LOAD} = 0$		
Undervoltage Lockout	V_{TH}	—	4.25	4.35	V	Upper Threshold
	V_{TL}	3.9	4.15	—	V	Lower Threshold
Feedback Bias Current	I_{FB}	—	60	150	nA	MIC2177 [Adj.]
		—	20	40	μA	MIC2177-5.0, MIC2177-3.3
Error Amplifier Gain	A_{VOL}	5	18	30	V	$0.6V \leq V_{COMP} \leq 0.8V$
Error Amplifier Output Swing	—	0.9	1.5	—	V	Upper Limit
		—	0.05	0.1	V	Lower Limit
Error Amplifier Output Current	—	15	25	38	μA	Source and Sink
Oscillator Frequency	f_O	160	200	240	kHz	—
Maximum Duty Cycle	D_{MAX}	100	—	—	%	$V_{FB} = 1.0V$
Maximum On-Time	$t_{ON(MIN)}$	—	300	400	ns	$V_{FB} = 1.5V$

MIC2177

ELECTRICAL CHARACTERISTICS

Electrical Characteristics: $V_{IN} = 7.0V$; $T_A = +25^{\circ}C$, **Bold** values indicate $-40^{\circ}C \leq T_A \leq +85^{\circ}C$; unless otherwise specified.

Parameter	Symbol	Min.	Typ.	Max.	Units	Conditions
SYNC Frequency Range	—	220	—	300	kHz	—
SYNC Threshold	—	0.8	1.6	2.2	V	—
SYNC Minimum Pule Width	—	500	—	—	ns	—
SYNC Leakage	I_{SYNC}	-1	0.01	1	μA	$V_{SYNC} = 0V$ to 5.5V
Current Limit	I_{LIM}	3.8	4.7	5.7	A	PWM Mode, $V_{IN} = 12V$
		—	600	—	mA	Skip Mode
Switch On-Resistance	R_{ON}	—	90	250	m Ω	High-Side Switch, $V_{IN} = 12V$
		—	110	250	m Ω	Low-Side Switch, $V_{IN} = 12V$
Output Switch Leakage	I_{SW}	—	1	10	μA	$V_{SW} = 16.5V$
Enable Threshold	—	0.8	1.6	2.2	V	—
Enable Leakage	I_{EN}	-1	0.01	1	μA	$V_{EN} = 0V$ to 5.5V
AUTO Threshold	—	0.8	1.6	—	V	—
AUTO Source Current	—	7	11	15	μA	$V_{FB} = 1.5V$, $V_{AUTO} < 0.8V$
Minimum Switch Current for PWM Operation	—	—	220	—	mA	$V_{IN} - V_{OUT} = 0V$
		—	420	—	mA	$V_{IN} - V_{OUT} = 3V$

TEMPERATURE SPECIFICATIONS (Note 1)

Parameters	Symbol	Min.	Typ.	Max.	Units	Conditions
Temperature Ranges						
Junction Temperature Range	T_J	-40	—	+125	°C	—

Note 1: The maximum allowable power dissipation is a function of ambient temperature, the maximum allowable junction temperature and the thermal resistance from junction to air (i.e., T_A , T_J , θ_{JA}). Exceeding the maximum allowable power dissipation will cause the device operating junction temperature to exceed the maximum +125°C rating. Sustained junction temperatures above +125°C can impact the device reliability.

MIC2177

2.0 TYPICAL PERFORMANCE CURVES

Note: The graphs and tables provided following this note are a statistical summary based on a limited number of samples and are provided for informational purposes only. The performance characteristics listed herein are not tested or guaranteed. In some graphs or tables, the data presented may be outside the specified operating range (e.g., outside specified power supply range) and therefore outside the warranted range.

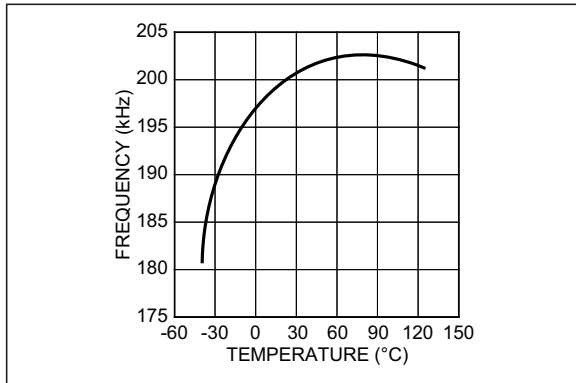

FIGURE 2-1: Oscillator Frequency vs. Temperature.

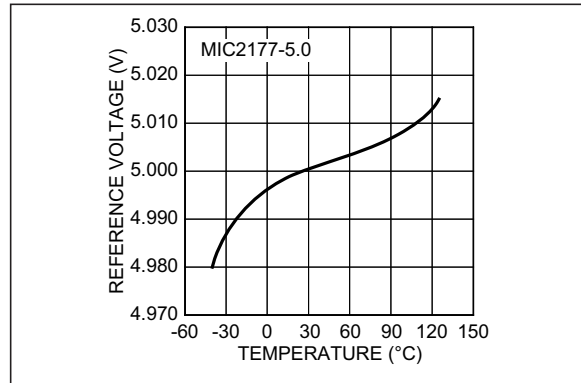

FIGURE 2-4: Reference Voltage vs. Temperature.

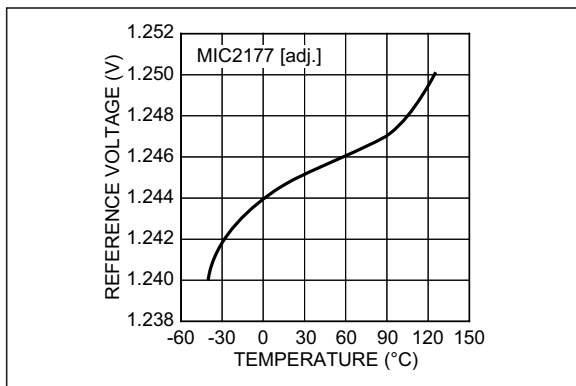

FIGURE 2-2: Reference Voltage vs. Temperature.

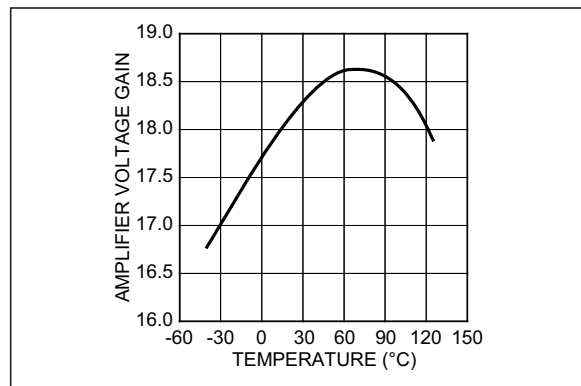

FIGURE 2-5: Error Amplifier Gain vs. Temperature.

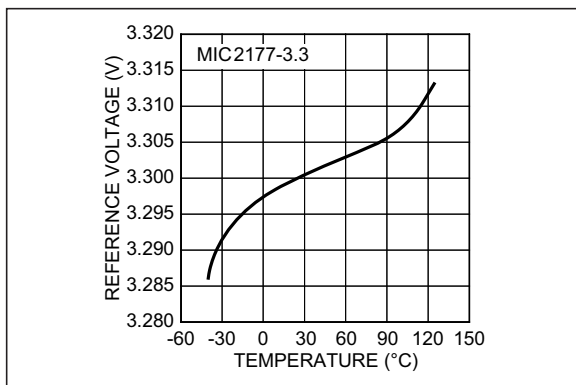

FIGURE 2-3: Reference Voltage vs. Temperature.

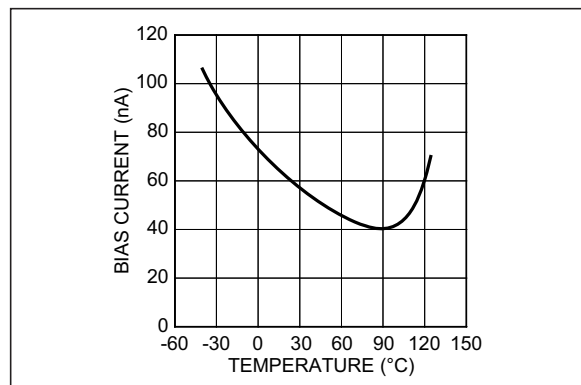

FIGURE 2-6: Feedback Input Bias Current vs. Temperature.

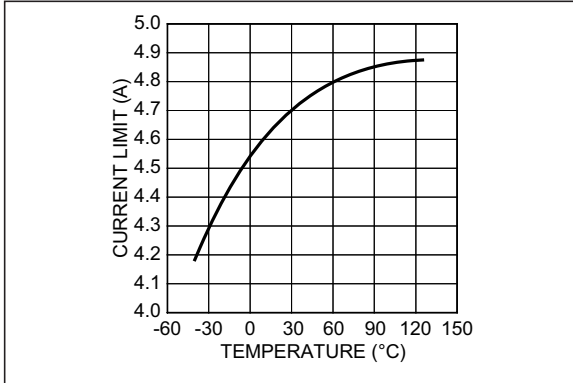

FIGURE 2-7: Current Limit vs. Temperature.

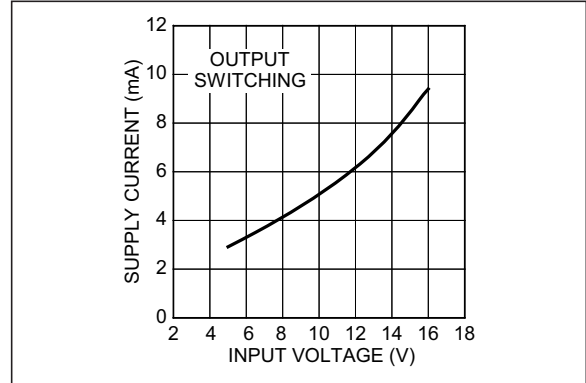

FIGURE 2-10: PWM Mode Supply Current.

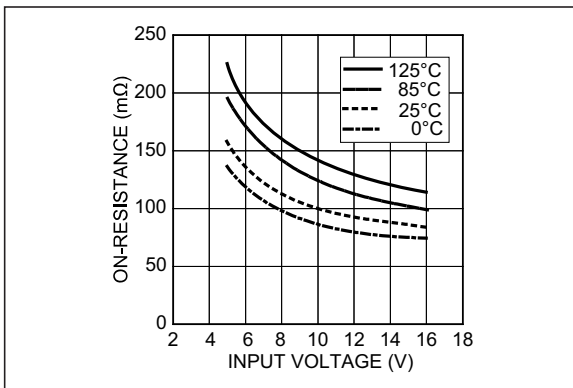

FIGURE 2-8: High-Side Switch On-Resistance.

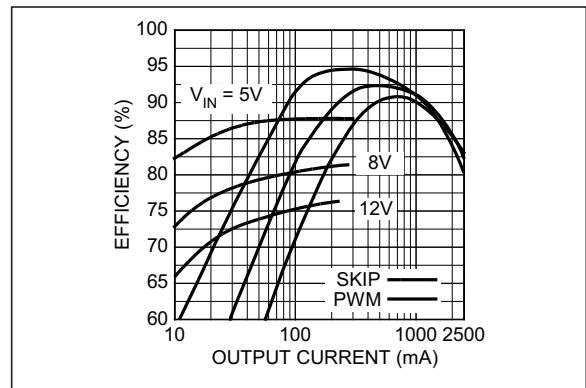

FIGURE 2-11: 3.3V Output Efficiency.

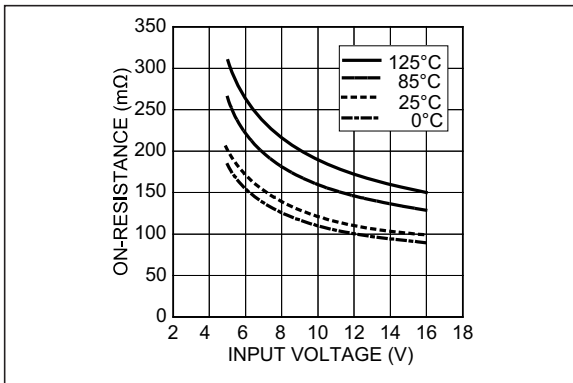

FIGURE 2-9: Low-Side Switch On-Resistance.

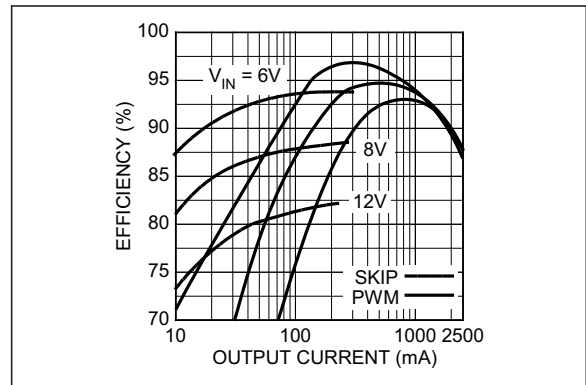

FIGURE 2-12: 5V Output Efficiency.

MIC2177

3.0 PIN DESCRIPTIONS

The descriptions of the pins are listed in [Table 3-1](#).

TABLE 3-1: PIN FUNCTION TABLE

Pin Number	Pin Name	Description
1, 2, 9	VIN	Supply Input: Controller and switch supply. Unregulated supply input to internal regulator, output switches, and control circuitry. Requires bypass capacitor to PGND. All three pins must be connected to VIN.
3, 8	SW	Switch (Output): Internal power MOSFET switch output. Both pins must be externally connected together.
4, 5, 6, 7	PGND	Power Ground: Output stage ground connections. Connect all pins to a common ground plane.
10	OUT	Output Voltage Sense (Input): Senses output voltage to determine minimum switch current for PWM operation. Connect directly to OUT.
11	AUTO	Automatic Mode: Connect 2.2 nF timing capacitor for automatic PWM/Skip mode switching. Regulator operates exclusively in PWM mode when pin is pulled low.
12	FB	Feedback (Input): Error amplifier inverting input. For adjustable output version, connect FB to external resistive divider to set output voltage. For 3.3V and 5V fixed output versions, connect FB directly to output.
13	COMP	Compensation: Internal error amplifier output. Connect to capacitor or series RC network to compensate the regulator control loop.
14, 15, 16, 17	SGND	Signal Ground: Ground connection of control section. Connect all pins to common ground plane.
18	SYNC	Frequency Synchronization (Input): Optional clock input. Connect to external clock signal to synchronize oscillator. Leading edge of signal above 1.7V terminates switching cycle. Connect to SGND if not used.
19	BIAS	Bias Supply: Internal 3.3V bias supply output. Decouple with 0.01 μ F bypass capacitor and 10 k Ω to SGND. Do not apply any external load.
20	EN	Enable (Input): Logic high enables operation. Logic low shuts down regulator. Do not allow pin to float.

4.0 FUNCTIONAL DESCRIPTION

The MIC2177 is a synchronous buck regulator that operates from an input voltage of 4.5V to 16.5V and provides a regulated output voltage of 1.25V to 16.5V. It has internal power MOSFETs that supply up to 2.5A of load current and operates with up to 100% duty cycle to allow low dropout operation. To optimize efficiency, the MIC2177 operates in PWM and skip mode. Skip mode provides the best efficiency when load current is less than 200 mA, while PWM mode is more efficient at higher current. A patented technique allows the MIC2177 to automatically select the correct operating mode as the load current changes.

During PWM operation, the MIC2177 uses current mode control that provides superior line regulation and makes the control loop easier to compensate. The PWM switching frequency is set internally to 200 kHz and can be synchronized to an external clock frequency up to 300 kHz. Other features include a low current shutdown mode, current limit, undervoltage lockout, and thermal shutdown.

4.1 Switch Output

The switch output (SW) is a half H-bridge consisting of a high side P-channel and low side N-channel power MOSFET. These MOSFETs have a typical on-resistance of 100 mΩ when the MIC2177 operates from a 12V supply. Anti shoot through circuitry prevents the P-channel and N-channel from turning on at the same time.

4.2 Undervoltage Lockout

Undervoltage lockout (UVLO) turns off the output when the input voltage (V_{IN}) is too low to provide sufficient gate drive for the output MOSFETs. It prevents the output from turning on until V_{IN} exceeds 4.3V. Once operating, the output will not shut off until V_{IN} drops below 4.2V.

4.3 Thermal Shutdown

Thermal shutdown turns off the output when the MIC2177 junction temperature exceeds the maximum value for safe operation. After thermal shutdown occurs, the output will not turn on until the junction temperature drops approximately 10°C.

4.4 Shutdown Mode

The MIC2177 has a low-current shutdown mode that is controlled by the enable input (EN). When a logic 0 is applied to EN, the MIC2177 is in shutdown mode and its quiescent current drops to less than 5 μA.

4.5 Internal Bias Regulator

An internal 3.3V regulator provides power to the MIC2177 control circuits. This internal supply is brought out to the BIAS pin for bypassing by an external 0.01 μF capacitor. Do not connect any external load to the BIAS pin. It is not designed to provide an external supply voltage.

4.6 Frequency Synchronization

The MIC2177 operates at a preset switching frequency of 200 kHz. It can be synchronized to a higher frequency by connecting an external clock to the SYNC pin. The SYNC pin is a logic level input that synchronizes the oscillator to the rising edge of an external clock signal. It has a frequency range of 220 kHz to 300 kHz, and can operate with a minimum pulse-width of 500 ns. If synchronization is not required, connect SYNC to ground.

4.7 Low-Dropout Operation

Output regulation is maintained in PWM or skip mode even when the difference between V_{IN} and V_{OUT} decreases below 1V. As $V_{IN} - V_{OUT}$ decreases, the duty cycle increases until it reaches 100%. At this point, the P-channel is kept on for several cycles at a time, and the output stays in regulation until $V_{IN} - V_{OUT}$ falls below the dropout voltage (dropout voltage = P-channel on resistance × load current).

4.8 PWM Mode Operation

Refer to [PWM Mode Functional Block Diagram](#) and [Timing Diagram](#) which is a simplified block diagram of the MIC2177 operating in PWM mode with its associated waveforms.

When operating in PWM mode, the output P-channel and N-channel MOSFETs are alternately switched on at a constant frequency and variable duty cycle. A switching period begins when the oscillator generates a reset pulse. This pulse resets the RS latch which turns on the P-channel and turns off the N-channel. During this time, inductor current (I_{L1}) increases and energy is stored in the inductor. The current sense amplifier (I_{SENSE} Amp) measures the P-channel drain-to-source voltage and outputs a voltage proportional to I_{L1} . The output of I_{SENSE} Amp is added to a saw tooth waveform (corrective ramp) generated by the oscillator, creating a composite waveform labeled I_{SENSE} on the timing diagram. When I_{SENSE} is greater than the error amplifier output, the PWM comparator will set the RS latch which turns off the P-channel and turns on the N-channel. Energy is then discharged from the inductor and I_{L1} decreases until the next switching cycle begins. By varying the P-channel on-time (duty cycle), the average inductor current is adjusted to whatever value is required to regulate the output voltage.

MIC2177

The MIC2177 uses current-mode control to adjust the duty cycle and regulate the output voltage. Current-mode control has two signal loops that determine the duty cycle. One is an outer loop that senses the output voltage, and the other is a faster inner loop that senses the inductor current. Signals from these two loops control the duty cycle in the following way: V_{OUT} is fed back to the error amplifier which compares the feedback voltage (V_{FB}) to an internal reference voltage (V_{REF}). When V_{OUT} is lower than its nominal value, the error amplifier output voltage increases. This voltage then intersects the current sense waveform later in switching period which increases the duty cycle and average inductor current. If V_{OUT} is higher than nominal, the error amplifier output voltage decreases, reducing the duty cycle.

The PWM control loop is stabilized in two ways. First, the inner signal loop is compensated by adding a corrective ramp to the output of the current sense amplifier. This allows the regulator to remain stable when operating at greater than 50% duty cycle. Second, a series resistor capacitor load is connected to the error amplifier output (COMP pin). This places a pole zero pair in the regulator control loop.

One more important item is synchronous rectification. As mentioned earlier, the N-channel output MOSFET is turned on after the P-channel turns off. When the N-channel turns on, its on resistance is low enough to create a short across the output diode. As a result, inductor current flows through the N-channel and the voltage drop across it is significantly lower than a diode forward voltage. This reduces power dissipation and improves efficiency to greater than 95% under certain operating conditions.

To prevent shoot through current, the output stage employs break before make circuitry that provides approximately 50 ns of delay from the time one MOSFET turns off and the other turns on. As a result, inductor current briefly flows through the output diode during this transition.

4.9 Skip Mode Operation

Refer to [Skip Mode Functional Block Diagram and Timing Diagram](#) which is a simplified block diagram of the MIC2177 operating in skip mode and its associated waveforms.

Skip-mode operation turns on the output P-channel at a frequency and duty cycle that is a function of V_{IN} , V_{OUT} , and the output inductor value. While in skip mode, the N-channel is kept off to optimize efficiency by reducing gate charge dissipation. V_{OUT} is regulated by skipping switching cycles that turn on the P-channel.

To begin analyzing MIC2177 skip mode operation, assume the skip mode comparator output is high and the latch output has been reset to a logic 1. This turns on the P-channel and causes I_{L1} to increase linearly until it reaches a current limit of 600 mA. When I_{L1}

reaches this value, the current limit comparator sets the RS latch output to logic 0, turning off the P-channel. The output switch voltage (V_{SW}) then swings from V_{IN} to 0.4V below ground, and I_{L1} flows through the Schottky diode. L1 discharges its energy to the output and I_{L1} decreases to zero. When $I_{L1} = 0$, V_{SW} swings from -0.4V to V_{OUT} , and this triggers a one-shot that resets the RS latch. Resetting the RS latch turns on the P-channel, which begins another switching cycle.

The skip mode comparator regulates V_{OUT} by controlling when the MIC2177 skips cycles. It compares V_{FB} to V_{REF} and has 10 mV of hysteresis to prevent oscillations in the control loop. When V_{FB} is less than $V_{REF} - 5$ mV, the comparator output is logic 1, allowing the P-channel to turn on. Conversely, when V_{FB} is greater than $V_{REF} + 5$ mV, the P-channel is turned off.

Note that this is a self-oscillating topology which explains why the switching frequency and duty cycle are a function of V_{IN} , V_{OUT} , and the value of L1. It has the unique feature (for a pulse skipping regulator) of supplying the same value of maximum load current for any value of V_{IN} , V_{OUT} , or L1. This allows the MIC2177 to always supply up to 300 mA of load current (I_{LOAD}) when operating in skip mode.

4.10 Changing from PWM to Skip Mode

Refer to the [Functional Block Diagram](#) for circuits described in the following sections.

The MIC2177 automatically changes from PWM to skip mode operation when I_{LOAD} drops below a minimum value. I_{MIN} is determined indirectly by detecting when the peak inductor current ($I_{L(peak)}$) is less than 420 mA. This is done by the minimum current comparator which detects if the output P-Channel current equals 420 mA during each switching cycle. If it does not, the PWM/skip mode select logic places the MIC2177 into skip mode operation.

The value of I_{MIN} that corresponds to $I_{L1(peak)} = 420$ mA is given by the following equation:

EQUATION 4-1:

$$I_{MIN} = \frac{420mA - \Delta I_{L1}}{2}$$

Where:

ΔI_{L1} = Inductor Ripple Current

Equation 4-1 shows I_{MIN} varies as a function of ΔI_L . Therefore, the user must select an inductor value that results in $I_{MIN} = 200$ mA when $I_{L(peak)} = 420$ mA. The formulas for calculating the correct inductor value are given in [Section 5.0, Applications Information](#). Note

that ΔI_L varies as a function of input voltage, and this also causes I_{MIN} to vary. In applications where the input voltage changes by a factor of two, I_{MIN} will typically vary from 130 mA to 250 mA.

During low dropout operation, the minimum current threshold circuit reduces the minimum value of $I_{L1(peak)}$ for PWM operation. This compensates for ΔI_{L1} decreasing to almost zero when the difference between V_{IN} and V_{OUT} is very low.

4.11 Switching from Skip to PWM Mode

The MIC2177 will automatically change from skip to PWM mode when I_{LOAD} exceeds 300 mA. During skip mode operation, it can supply up to 300 mA, and when I_{LOAD} exceeds this limit, V_{OUT} will fall below its nominal value. At this point, the MIC2177 begins operating in PWM mode. Note that the maximum value of I_{LOAD} for skip mode is greater than the minimum value required for PWM mode. This current hysteresis prevents the MIC2177 from toggling between modes when I_{LOAD} is in the range of 100 mA to 300 mA.

The low output comparator determines when V_{OUT} is low enough for the regulator to change operating modes. It detects when the feedback voltage is 3% below nominal, and pulls the AUTO pin to ground. When AUTO is less than 1.6V, the PWM/Skip-mode select logic places the MIC2177 into PWM operation. The external 2.2 nF capacitor connected to AUTO is charged by a 10 μ A current source after the regulator begins operating in PWM mode. As a result, AUTO stays below 1.6V for several switching cycles after PWM operation begins, forcing the MIC2177 to remain in PWM mode during this transition.

4.12 External PWM Mode Selection

The MIC2177 can be forced to operate in only PWM mode by connecting AUTO to ground. This prevents skip mode operation in applications that are sensitive to switching noise.

MIC2177

PWM Mode Functional Block Diagram and Timing Diagram

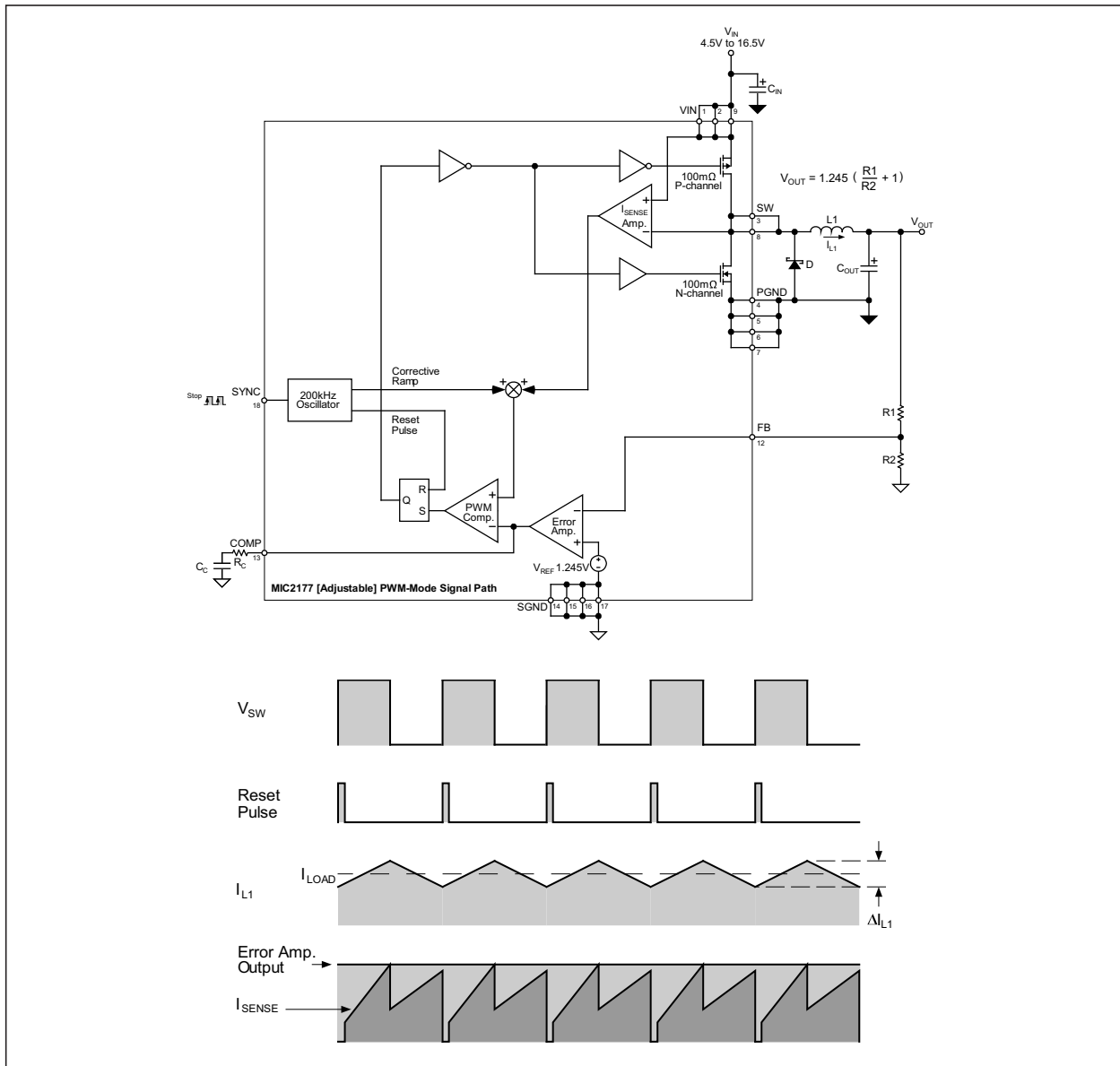

Skip Mode Functional Block Diagram and Timing Diagram

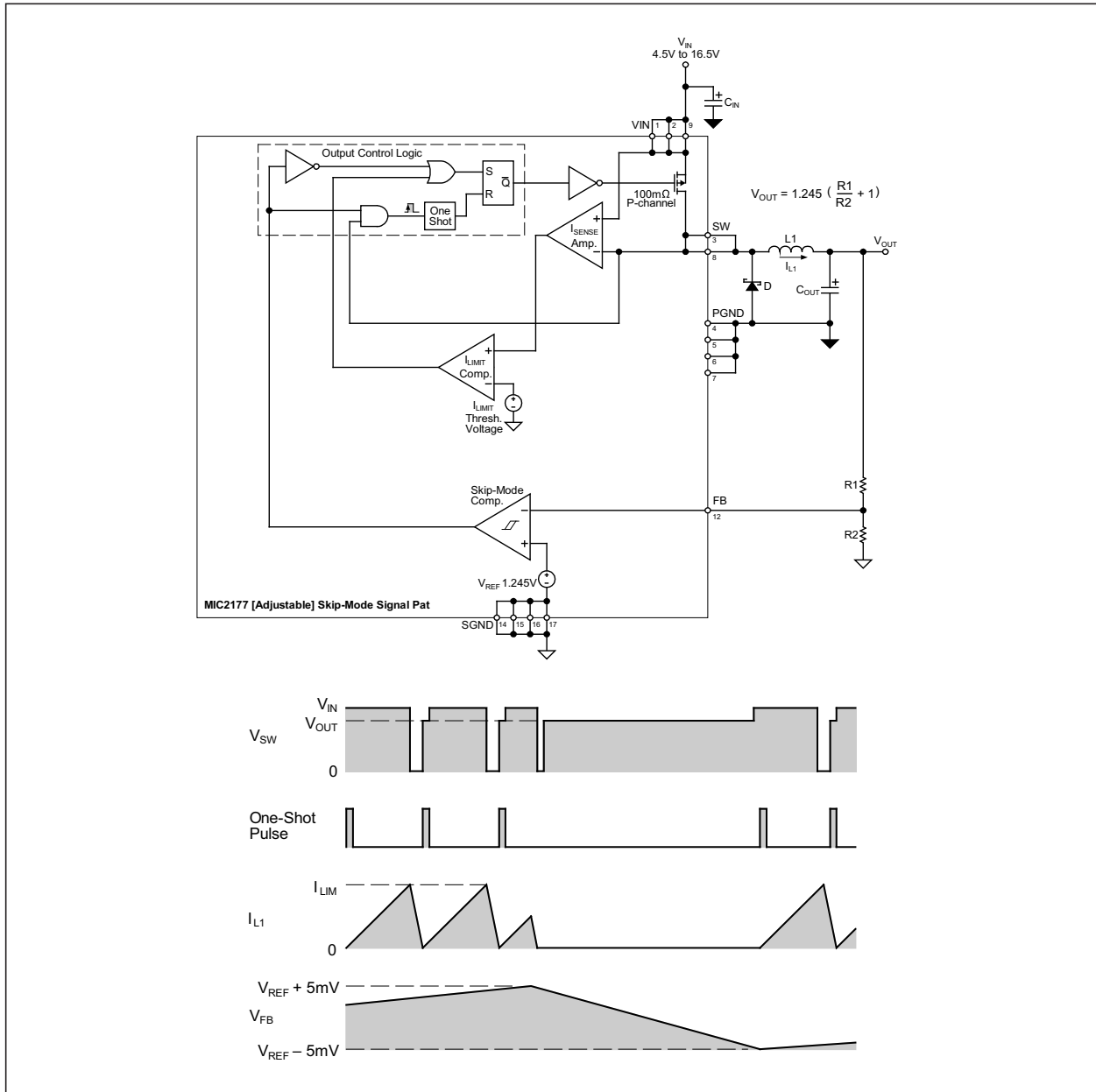

5.0 APPLICATIONS INFORMATION

5.1 Feedback Resistor Selection (Adjustable Version)

The output voltage is configured by connecting an external resistive divider to the FB pin as shown in [Functional Block Diagram](#). The ratio of R1 to R2 determines the output voltage. To optimize efficiency during low output current operation, R2 should not be less than 20 kΩ. However, to prevent feedback error due to input bias current at the FB pin, R2 should not be greater than 100 kΩ. After selecting R2, calculate R1 using the following formula:

EQUATION 5-1:

$$R1 = R2 \left[\left(\frac{V_{OUT}}{1.245V} \right) - 1 \right]$$

5.2 Input Capacitor Selection

The input capacitor is selected for its RMS current and voltage rating and should be a low ESR (equivalent series resistance) electrolytic or tantalum capacitor. As a rule of thumb, the voltage rating for a tantalum capacitor should be twice the value of V_{IN} , and the voltage rating for an electrolytic should be 40% higher than V_{IN} . The RMS current rating must be equal or greater than the maximum RMS input ripple current. A simple, worst case formula for calculating this RMS current is:

EQUATION 5-2:

$$I_{RMS(MAX)} = \frac{I_{LOAD(MAX)}}{2}$$

Tantalum capacitors are a better choice for applications that require the most compact layout or operation below 0°C. The input capacitor must be located very close to the V_{IN} pin (within 0.2 inches, 5 mm). Also place a 0.1 μF ceramic bypass capacitor as close as possible to V_{IN} .

5.3 Inductor Selection

The inductor must be at least a minimum value in order for the MIC2177 to change from PWM to skip mode at the correct value of output current. This minimum value ensures the inductor ripple current never exceeds 600 mA, and is calculated using the following formula:

EQUATION 5-3:

$$L_{MIN} = V_{OUT} \left(1 - \frac{V_{OUT}}{V_{IN(MAX)}} \right) \times 8.3 \mu H$$

Where:

$V_{IN(MAX)}$ = Maximum Input Voltage

In general, a value at least 20% greater than L_{MIN} should be selected because inductor values have a tolerance of ±20%.

Two other parameters to consider in selecting an inductor are winding resistance and peak current rating. The inductor must have a saturation current rating equal or greater than the peak inductor current. Otherwise, the inductor may saturate, causing excessive current in the output switch. Also, the inductor's core loss may increase significantly. Both of these effects will degrade efficiency. The formula for peak inductor current is:

EQUATION 5-4:

$$I_{L(PEAK)} = I_{LOAD(MAX)} + 300mA$$

To maximize efficiency, the inductor's resistance must be less than the output switch on-resistance (preferably 50 mΩ or less).

5.4 Output Capacitor Selection

Select an output capacitor that has a low value of ESR. This parameter determines a regulator's output ripple voltage (V_{RIPPLE}) which is generated by $\Delta I_L \times ESR$. As mentioned in [Section 5.3, Inductor Selection](#) the maximum value for ΔI_L is 600 mA.

Therefore, the maximum value of ESR is:

EQUATION 5-5:

$$ESR_{(MAX)} = \frac{V_{RIPPLE}}{600mA}$$

Where:

$$V_{RIPPLE} < 1\% \text{ of } V_{OUT}$$

Typically, capacitors in the range of 100 μ F to 220 μ F have ESR less than this maximum value. The output capacitor can be either a low ESR electrolytic or tantalum capacitor, but tantalum is a better choice for compact layout and operation at temperatures below 0°C. The voltage rating of a tantalum capacitor must be $2 \times V_{OUT}$, and the voltage rating of an electrolytic must be $1.4 \times V_{OUT}$.

5.5 Output Diode Selection

In PWM operation, inductor current flows through the output diode approximately 50 ns during the dead time when one output MOSFET turns off and the other turns on. In skip mode, the inductor current flows through the diode during the entire P-channel off time. The correct diode for both of these conditions is a 1A diode with a reverse voltage rating greater than V_{IN} . It must be a Schottky or ultra-fast recovery diode ($t_R < 100$ ns) to minimize power dissipation from the diode's reverse recovery charge.

5.6 Compensation

Compensation is provided by connecting a series RC load to the COMP pin. This creates a pole zero pair in the regulator control loop, allowing the regulator to remain stable with enough low frequency loop gain for good load and line regulation. At higher frequencies pole zero reduces loop gain to a level referred to as the mid band gain. The mid band gain is low enough so that the loop gain crosses 0 dB with sufficient phase margin. Typical values for the RC load are 4.7 nF to 10 nF for the capacitor and 5 k Ω to 20 k Ω for the resistor.

5.7 Printed Circuit Board Layout

A well designed PC board will prevent switching noise and ground bounce from interfering with the operation of the MIC2177. A good design takes into consideration component placement and routing of power traces.

The first thing to consider is the locations of the input capacitor, inductor, output diode, and output capacitor. The input capacitor must be placed very close to the VIN pin, the inductor and output diode very close to the SW pin, and the output capacitor near the inductor. These components pass large high frequency current pulses, so they must use short, wide power traces. In addition, their ground pins and PGND are connected to a ground plane that is nearest the power supply ground bus.

The feedback resistors, RC compensation network, and BIAS pin bypass capacitor should be located near their respective pins. To prevent ground bounce, their ground traces and SGND should not be in the path of switching currents returning to the power supply ground bus. SGND and PGND should be tied together by a ground plane that extends under the MIC2177.

MIC2177

6.0 PACKAGING INFORMATION

6.1 Package Marking Information

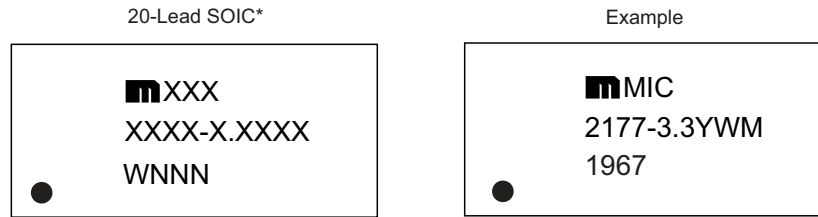

Legend:	XX...X	Product code or customer-specific information
	Y	Year code (last digit of calendar year)
	YY	Year code (last 2 digits of calendar year)
	WW	Week code (week of January 1 is week '01')
	NNN	Alphanumeric traceability code
	(e3)	Pb-free JEDEC® designator for Matte Tin (Sn)
	*	This package is Pb-free. The Pb-free JEDEC designator (e3) can be found on the outer packaging for this package.
	●, ▲, ▼	Pin one index is identified by a dot, delta up, or delta down (triangle mark).
Note:	In the event the full Microchip part number cannot be marked on one line, it will be carried over to the next line, thus limiting the number of available characters for customer-specific information. Package may or may not include the corporate logo.	
	Underbar () and/or Overbar () symbol may not be to scale.	

20-Lead SOIC (WM) Package Outline and Recommended Land Pattern

TITLE

20 LEAD SOICW PACKAGE OUTLINE & RECOMMENDED LAND PATTERN

DRAWING #	SOICW-20LD-PL-1	UNIT	INCH [MM]
-----------	-----------------	------	-----------

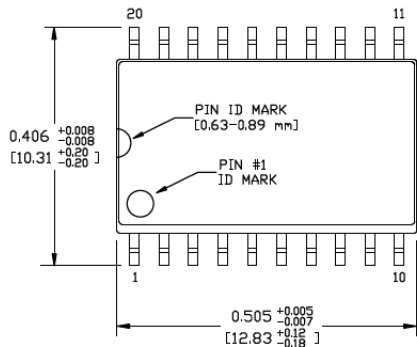

TOP VIEW
NOTE 1, 2

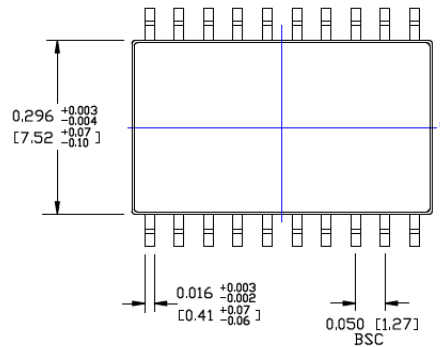

BOTTOM VIEW
NOTE 1, 2

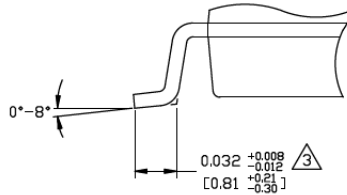

DETAIL "A"

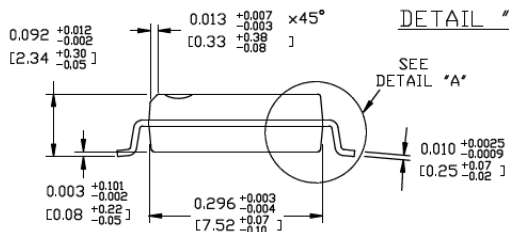

END VIEW
NOTE 1, 2, 3

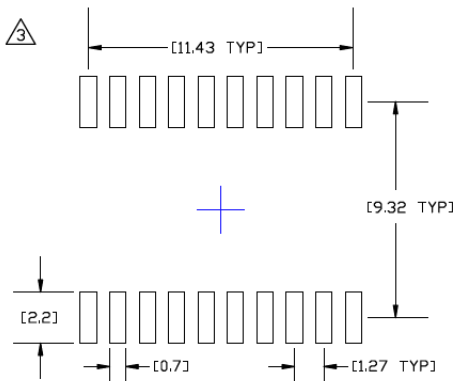

RECOMMENDED LAND PATTERN

NOTES:

1. DIMENSIONS ARE IN INCHES[MM].
2. CONTROLLING DIMENSION: INCHES.
3. DIMENSION DOES NOT INCLUDE MOLD FLASH OR PROTRUSIONS, EITHER OF WHICH SHALL NOT EXCEED 0.006[0.15] PER SIDE.

Note: For the most current package drawings, please see the Microchip Packaging Specification located at <http://www.microchip.com/packaging>.

MIC2177

NOTES:

APPENDIX A: REVISION HISTORY

Revision A (March 2020)

- Converted Micrel document MIC2177 to Microchip data sheet DS20006298A.
- Minor text changes throughout.

MIC2177

NOTES:

PRODUCT IDENTIFICATION SYSTEM

To order or obtain information, e.g., on pricing or delivery, contact your local Microchip representative or sales office.

<u>PART NO.</u>	<u>-X.X</u>	<u>X</u>	<u>XX</u>	<u>-XX</u>
Device	Output Voltage	Junction Temperature Range	Package	Media Type
Device: Output Voltage: Junction Temperature Range: Package: Media Type:	MIC2177: 2.5A Synchronous Buck Regulator Blank = Adjustable -3.3 = -3.3V -5.0 = -5.0V	Y = -40°C to +85°C	WM = 20-Lead SOIC	Blank = 48/Tube TR = 1,000/Reel
Examples:				
a) MIC2177YWM: 2.5A Synchronous Buck Regulator, ADJ Output Voltage, -40°C to +85°C Junction Temperature Range, 20-Lead SOIC Package, 48/Tube b) MIC2177YWM-TR: 2.5A Synchronous Buck Regulator, ADJ Output Voltage, -40°C to +85°C Junction Temperature Range, 20-Lead SOIC Package, 1000/Reel c) MIC2177-3.3YWM: 2.5A Synchronous Buck Regulator, 3.3V, -40°C to +85°C Junction Temperature Range, 20-Lead SOIC Package, 48/Tube d) MIC2177-3.3YWM-TR: 2.5A Synchronous Buck Regulator, 3.3V, -40°C to +85°C Junction Temperature Range, 20-Lead SOIC Package, 1000/Reel e) MIC2177-5.0YWM: 2.5A Synchronous Buck Regulator, 5.0V, -40°C to +85°C Junction Temperature Range, 20-Lead SOIC Package, 48/Tube f) MIC2177-5.0YWM-TR: 2.5A Synchronous Buck Regulator, 5.0V, -40°C to +85°C Junction Temperature Range, 20-Lead SOIC Package, 1000/Reel				
Note 1: Tape and Reel identifier only appears in the catalog part number description. This identifier is used for ordering purposes and is not printed on the device package. Check with your Microchip Sales Office for package availability with the Tape and Reel option.				

MIC2177

NOTES:

Note the following details of the code protection feature on Microchip devices:

- Microchip products meet the specification contained in their particular Microchip Data Sheet.
- Microchip believes that its family of products is one of the most secure families of its kind on the market today, when used in the intended manner and under normal conditions.
- There are dishonest and possibly illegal methods used to breach the code protection feature. All of these methods, to our knowledge, require using the Microchip products in a manner outside the operating specifications contained in Microchip's Data Sheets. Most likely, the person doing so is engaged in theft of intellectual property.
- Microchip is willing to work with the customer who is concerned about the integrity of their code.
- Neither Microchip nor any other semiconductor manufacturer can guarantee the security of their code. Code protection does not mean that we are guaranteeing the product as “unbreakable.”

Code protection is constantly evolving. We at Microchip are committed to continuously improving the code protection features of our products. Attempts to break Microchip's code protection feature may be a violation of the Digital Millennium Copyright Act. If such acts allow unauthorized access to your software or other copyrighted work, you may have a right to sue for relief under that Act.

Information contained in this publication regarding device applications and the like is provided only for your convenience and may be superseded by updates. It is your responsibility to ensure that your application meets with your specifications. MICROCHIP MAKES NO REPRESENTATIONS OR WARRANTIES OF ANY KIND WHETHER EXPRESS OR IMPLIED, WRITTEN OR ORAL, STATUTORY OR OTHERWISE, RELATED TO THE INFORMATION, INCLUDING BUT NOT LIMITED TO ITS CONDITION, QUALITY, PERFORMANCE, MERCHANTABILITY OR FITNESS FOR PURPOSE. Microchip disclaims all liability arising from this information and its use. Use of Microchip devices in life support and/or safety applications is entirely at the buyer's risk, and the buyer agrees to defend, indemnify and hold harmless Microchip from any and all damages, claims, suits, or expenses resulting from such use. No licenses are conveyed, implicitly or otherwise, under any Microchip intellectual property rights unless otherwise stated.

Trademarks

The Microchip name and logo, the Microchip logo, Adaptec, AnyRate, AVR, AVR logo, AVR Freaks, BesTime, BitCloud, chipKIT, chipKIT logo, CryptoMemory, CryptoRF, dsPIC, FlashFlex, flexPWR, HELDO, IGLOO, JukeBlox, KeeLoq, Klear, LANCheck, LinkMD, maXStylus, maXTouch, MediaLB, megaAVR, Microsemi, Microsemi logo, MOST, MOST logo, MPLAB, OptoLyzer, PackeTime, PIC, picoPower, PICSTART, PIC32 logo, PolarFire, Prochip Designer, QTouch, SAM-BA, SenGenuity, SpyNIC, SST, SST Logo, SuperFlash, Symmetricom, SyncServer, Tachyon, TempTrackr, TimeSource, tinyAVR, UNI/O, Vectron, and XMEGA are registered trademarks of Microchip Technology Incorporated in the U.S.A. and other countries.

APT, ClockWorks, The Embedded Control Solutions Company, EtherSynch, FlashTec, Hyper Speed Control, HyperLight Load, IntelliMOS, Libero, motorBench, mTouch, Powermite 3, Precision Edge, ProASIC, ProASIC Plus, ProASIC Plus logo, Quiet-Wire, SmartFusion, SyncWorld, Temux, TimeCesium, TimeHub, TimePictra, TimeProvider, Vite, WinPath, and ZL are registered trademarks of Microchip Technology Incorporated in the U.S.A.

Adjacent Key Suppression, AKS, Analog-for-the-Digital Age, Any Capacitor, AnyIn, AnyOut, BlueSky, BodyCom, CodeGuard, CryptoAuthentication, CryptoAutomotive, CryptoCompanion, CryptoController, dsPICDEM, dsPICDEM.net, Dynamic Average Matching, DAM, ECAN, EtherGREEN, In-Circuit Serial Programming, ICSP, INICnet, Inter-Chip Connectivity, JitterBlocker, KlearNet, KlearNet logo, memBrain, Mindi, MiWi, MPASM, MPF, MPLAB Certified logo, MPLIB, MPLINK, MultiTRAK, NetDetach, Omniscient Code Generation, PICDEM, PICDEM.net, PICKit, PICtail, PowerSmart, PureSilicon, QMatrix, REAL ICE, Ripple Blocker, SAM-ICE, Serial Quad I/O, SMART-I.S., SQI, SuperSwitcher, SuperSwitcher II, Total Endurance, TSHARC, USBCheck, VariSense, ViewSpan, WiperLock, Wireless DNA, and ZENA are trademarks of Microchip Technology Incorporated in the U.S.A. and other countries.

SQTP is a service mark of Microchip Technology Incorporated in the U.S.A.

The Adaptec logo, Frequency on Demand, Silicon Storage Technology, and Symmcom are registered trademarks of Microchip Technology Inc. in other countries.

GestIC is a registered trademark of Microchip Technology Germany II GmbH & Co. KG, a subsidiary of Microchip Technology Inc., in other countries.

All other trademarks mentioned herein are property of their respective companies.

© 2020, Microchip Technology Incorporated, All Rights Reserved.

For information regarding Microchip's Quality Management Systems, please visit www.microchip.com/quality.

ISBN: 978-1-5224-5841-8



MICROCHIP

Worldwide Sales and Service

AMERICAS

Corporate Office
2355 West Chandler Blvd.
Chandler, AZ 85224-6199
Tel: 480-792-7200
Fax: 480-792-7277
Technical Support:
<http://www.microchip.com/support>
Web Address:
www.microchip.com

Atlanta

Duluth, GA
Tel: 678-957-9614
Fax: 678-957-1455

Austin, TX

Tel: 512-257-3370

Boston

Westborough, MA
Tel: 774-760-0087
Fax: 774-760-0088

Chicago

Itasca, IL
Tel: 630-285-0071
Fax: 630-285-0075

Dallas

Addison, TX
Tel: 972-818-7423
Fax: 972-818-2924

Detroit

Novi, MI
Tel: 248-848-4000

Houston, TX

Tel: 281-894-5983

Indianapolis

Noblesville, IN
Tel: 317-773-8323
Fax: 317-773-5453
Tel: 317-536-2380

Los Angeles

Mission Viejo, CA
Tel: 949-462-9523
Fax: 949-462-9608
Tel: 951-273-7800

Raleigh, NC

Tel: 919-844-7510

New York, NY

Tel: 631-435-6000

San Jose, CA

Tel: 408-735-9110
Tel: 408-436-4270

Canada - Toronto

Tel: 905-695-1980
Fax: 905-695-2078

ASIA/PACIFIC

Australia - Sydney
Tel: 61-2-9868-6733

China - Beijing
Tel: 86-10-8569-7000

China - Chengdu
Tel: 86-28-8665-5511

China - Chongqing
Tel: 86-23-8980-9588

China - Dongguan
Tel: 86-769-8702-9880

China - Guangzhou
Tel: 86-20-8755-8029

China - Hangzhou
Tel: 86-571-8792-8115

China - Hong Kong SAR
Tel: 852-2943-5100

China - Nanjing
Tel: 86-25-8473-2460

China - Qingdao
Tel: 86-532-8502-7355

China - Shanghai
Tel: 86-21-3326-8000

China - Shenyang
Tel: 86-24-2334-2829

China - Shenzhen
Tel: 86-755-8864-2200

China - Suzhou
Tel: 86-186-6233-1526

China - Wuhan
Tel: 86-27-5980-5300

China - Xian
Tel: 86-29-8833-7252

China - Xiamen
Tel: 86-592-2388138

China - Zhuhai
Tel: 86-756-3210040

ASIA/PACIFIC

India - Bangalore
Tel: 91-80-3090-4444

India - New Delhi
Tel: 91-11-4160-8631

India - Pune
Tel: 91-20-4121-0141

Japan - Osaka
Tel: 81-6-6152-7160

Japan - Tokyo
Tel: 81-3-6880-3770

Korea - Daegu
Tel: 82-53-744-4301

Korea - Seoul
Tel: 82-2-554-7200

Malaysia - Kuala Lumpur
Tel: 60-3-7651-7906

Malaysia - Penang
Tel: 60-4-227-8870

Philippines - Manila
Tel: 63-2-634-9065

Singapore
Tel: 65-6334-8870

Taiwan - Hsin Chu
Tel: 886-3-577-8366

Taiwan - Kaohsiung
Tel: 886-7-213-7830

Taiwan - Taipei
Tel: 886-2-2508-8600

Thailand - Bangkok
Tel: 66-2-694-1351

Vietnam - Ho Chi Minh
Tel: 84-28-5448-2100

EUROPE

Austria - Wels
Tel: 43-7242-2244-39
Fax: 43-7242-2244-393

Denmark - Copenhagen
Tel: 45-4485-5910
Fax: 45-4485-2829

Finland - Espoo
Tel: 358-9-4520-820

France - Paris
Tel: 33-1-69-53-63-20
Fax: 33-1-69-30-90-79

Germany - Garching
Tel: 49-8931-9700

Germany - Haan
Tel: 49-2129-3766400

Germany - Heilbronn
Tel: 49-7131-72400

Germany - Karlsruhe
Tel: 49-721-625370

Germany - Munich
Tel: 49-89-627-144-0
Fax: 49-89-627-144-44

Germany - Rosenheim
Tel: 49-8031-354-560

Israel - Ra'anana
Tel: 972-9-744-7705

Italy - Milan
Tel: 39-0331-742611
Fax: 39-0331-466781

Italy - Padova
Tel: 39-049-7625286

Netherlands - Drunen
Tel: 31-416-690399
Fax: 31-416-690340

Norway - Trondheim
Tel: 47-7288-4388

Poland - Warsaw
Tel: 48-22-3325737

Romania - Bucharest
Tel: 40-21-407-87-50

Spain - Madrid
Tel: 34-91-708-08-90
Fax: 34-91-708-08-91

Sweden - Gothenberg
Tel: 46-31-704-60-40

Sweden - Stockholm
Tel: 46-8-5090-4654

UK - Wokingham
Tel: 44-118-921-5800
Fax: 44-118-921-5820