

**GLASS PASSIVATED BRIDGE RECTIFIERS**  
VOLTAGE 1000 Volts CURRENT 2.0 Ampere

**FEATURES**

Glass passivated chip junction  
High case dielectric strength  
High surge current capability  
Ideal for printed circuit board

**MACHANICAL DATA**

Terminal:Plated leads solderable per MIL-STD 202E,  
Method 208C  
Case:UL-94 Class V-0 recognized Flame Retardant Epoxy  
Polarity:Polarity symbol marked on body  
Mounting position:any

**MAXIMUM RATINGS AND ELECTRICAL CHARACTERISTICS**

Rating at 25°C ambient temperature unless otherwise specified.  
Single phase, half wave, 60Hz, resistive or inductive load.  
For capacitive load, derate current by 20%

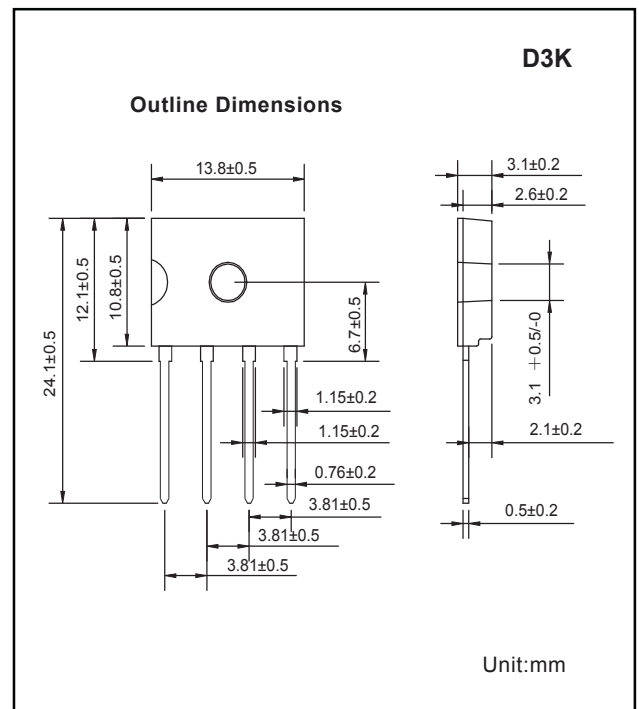

CHARACTERISTICS	SYMBOL	DRS201K	DRS202K	DRS203K	DRS204K	DRS205K	DRS206K	DRS207K	UNIT
Maximum Recurrent Peak Reverse Voltage	V <sub>RRM</sub>	50	100	200	400	600	800	1000	V
Maximum RMS Voltage	V <sub>RMS</sub>	35	70	140	280	420	560	700	V
Maximum DC Blocking Voltage	V <sub>DC</sub>	50	100	200	400	600	800	1000	V
Maximum Average Forward Rectified Output Current @ T <sub>c</sub> =138°C (with heatsink)	I <sub>(AV)</sub>	2							A
Peak Forward Surge Current 8.3ms Single Half Sine-Wave Super Imposed on Rated Load (JEDEC Method)	I <sub>FSM</sub>	60							A
Maximum Forward Voltage at 2.0A DC	V <sub>F</sub>	1.1							V
I <sup>2</sup> t Rating for Fusing (t<8.3ms)	I <sup>2</sup> t	14.94							A <sup>2</sup> s
Typical Thermal Resistance	without heatsink	R <sub>θJa</sub>							°C/W
	with heatsink	R <sub>θJC</sub>							
	without heatsink	R <sub>θJL</sub>							
Maximum DC Reverse Current at Rated DC Blocking Voltage	@ T <sub>a</sub> =25°C	I <sub>R</sub>							μA
	@ T <sub>a</sub> =125°C	500							
Operating Temperature Range	T <sub>J</sub>	-55 to +150							°C
Storage Temperature Range	T <sub>STG</sub>	-55 to +150							°C

# RATING AND CHARACTERISTICS CURVES ( DRS201K THRU DRS207K )

FIG.1-DERATING CURVE OUTPUT RECTIFIED CURRENT

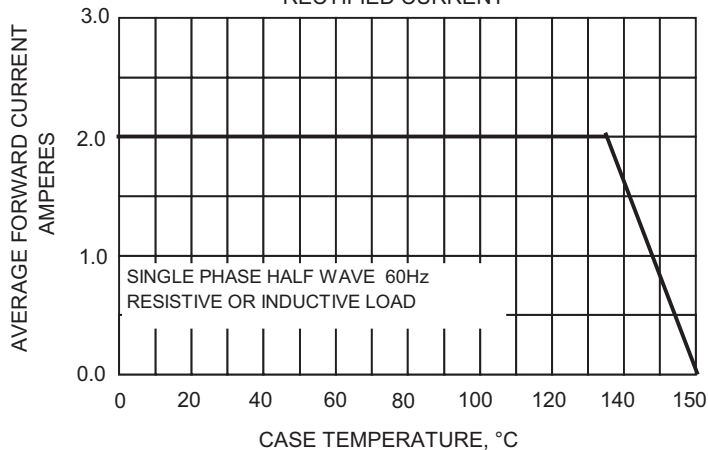

FIG.2-MAXIMUM NON-REPETITIVE SURGE CURRENT

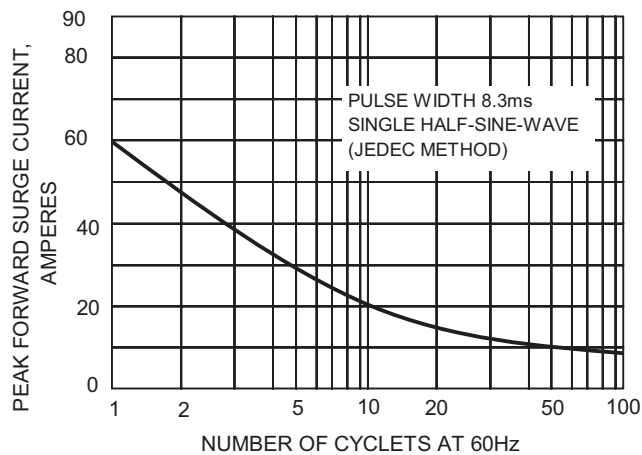

FIG.3-TYPICAL JUNCTION CAPACITANCE

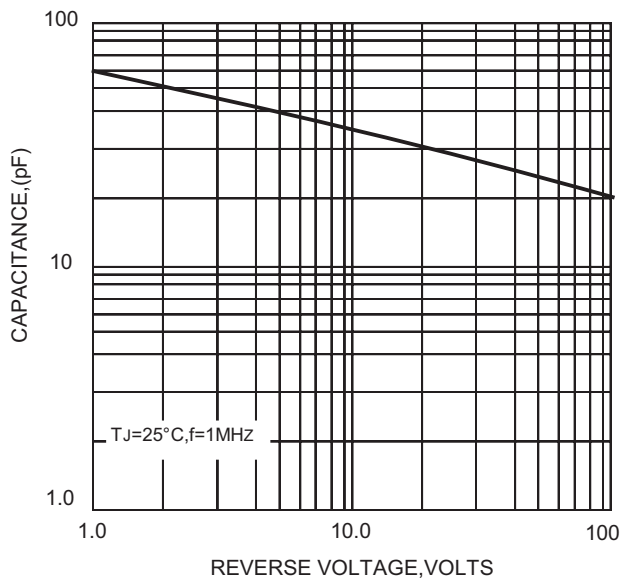

FIG.3-TYPICAL FORWARD CHARACTERISTICS

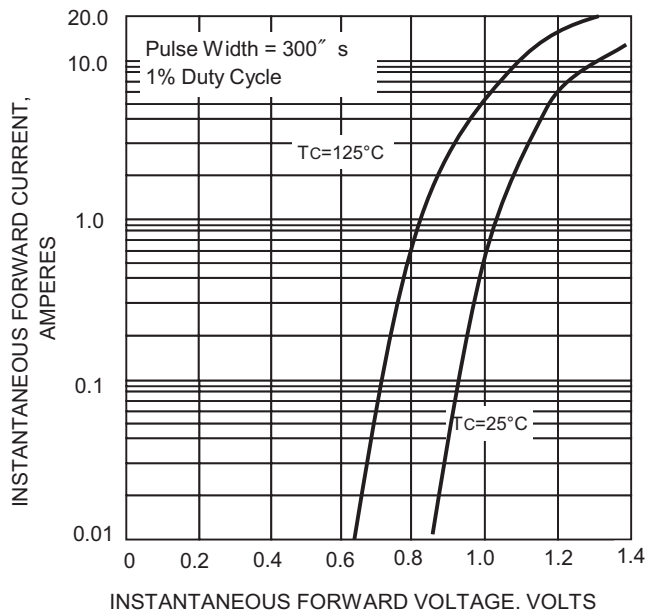
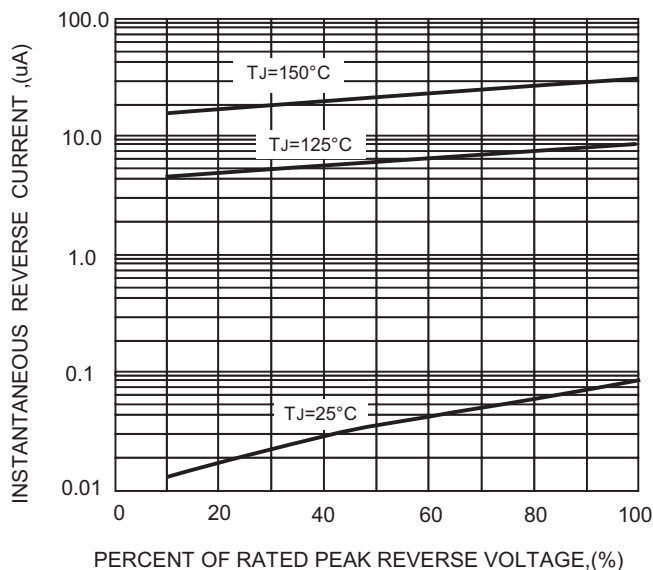
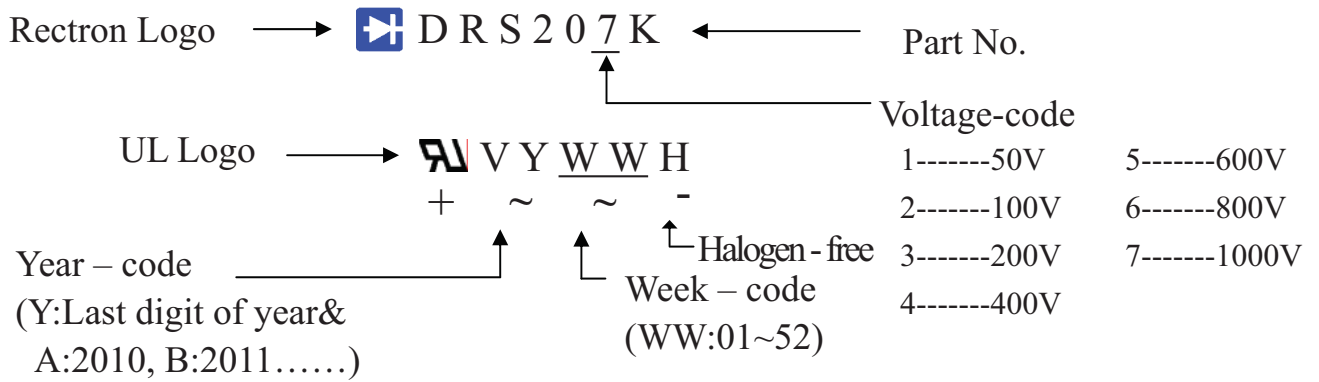

FIG.5-TYPICAL REVERSE CHARACTERISTICS



## Marking Description



## PACKAGING OF DIODE AND BRIDGE RECTIFIERS

### BULK PACK

PACKAGE	PACKING CODE	EA PER BOX	INNER BOX SIZE (mm)	CARTON SIZE (mm)	EA PER CARTON	GROSS WEIGHT(Kg)
D3K	-B	500	181*183*37	378*202*200	5,000	9.0

### TUBE PACK

PACKAGE	PACKING CODE	EA PER BOX	INNER BOX SIZE (mm)	CARTON SIZE (mm)	EA PER CARTON	WEIGHT(Kg)
D3K	-C	3,000	491*145*133	498*330*160	6,000	13.2

## DISCLAIMER NOTICE

Rectron Inc reserves the right to make changes without notice to any product specification herein, to make corrections, modifications, enhancements or other changes. Rectron Inc or anyone on its behalf assumes no responsibility or liability for any errors or inaccuracies. Data sheet specifications and its information contained are intended to provide a product description only. "Typical" parameters which may be included on RECTRON data sheets and/ or specifications can and do vary in different applications and actual performance may vary over time. Rectron Inc does not assume any liability arising out of the application or use of any product or circuit.

Rectron products are not designed, intended or authorized for use in medical, life-saving implant or other applications intended for life-sustaining or other related applications where a failure or malfunction of component or circuitry may directly or indirectly cause injury or threaten a life without expressed written approval of Rectron Inc. Customers using or selling Rectron components for use in such applications do so at their own risk and shall agree to fully indemnify Rectron Inc and its subsidiaries harmless against all claims, damages and expenditures.