



# STD95N4LF3

N-channel 40 V, 5.0 mΩ typ., 80 A STripFET™ III Power MOSFET in a DPAK package

Datasheet — production data

## Features

Type	V <sub>DSS</sub>	R <sub>DS(on) max</sub>	I <sub>D</sub>	P <sub>D</sub>
STD95N4LF3	40 V	< 6.0 mΩ	80 A <sup>(1)</sup>	110 W

1. Value limited by wire bonding

- 100% avalanche tested
- Logic level drive

## Applications

- Switching application
  - Automotive

## Description

This device is an N-channel enhancement mode Power MOSFET produced using STMicroelectronics' STripFET™ III technology, which is specifically designed to minimize on-resistance and gate charge to provide superior switching performance.

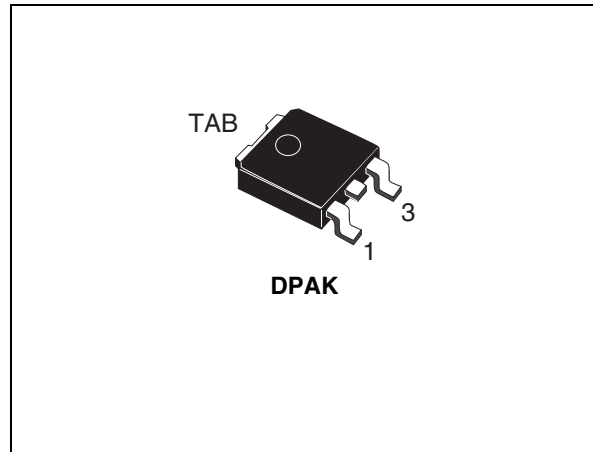

Figure 1. Internal schematic diagram

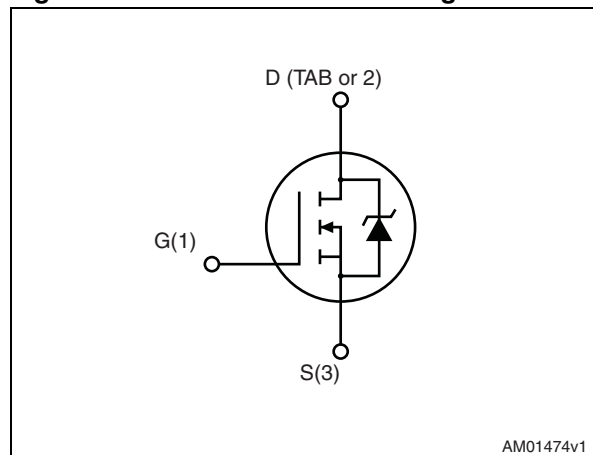

Table 1. Device summary

Order codes	Marking	Package	Packaging
STD95N4LF3	95N4LF3	DPAK	Tape and reel

# Contents

<b>1</b>	<b>Electrical ratings</b> .....	<b>3</b>
<b>2</b>	<b>Electrical characteristics</b> .....	<b>4</b>
2.1	Electrical characteristics (curves) .....	6
<b>3</b>	<b>Test circuits</b> .....	<b>8</b>
<b>4</b>	<b>Package mechanical data</b> .....	<b>10</b>
<b>5</b>	<b>Packing mechanical data</b> .....	<b>12</b>
<b>6</b>	<b>Revision history</b> .....	<b>14</b>

# 1 Electrical ratings

**Table 2. Absolute maximum ratings**

Symbol	Parameter	Value	Unit
$V_{DS}$	Drain-source voltage	40	V
$V_{GS}$	Gate-source voltage	$\pm 16$	V
$I_D^{(1)}$	Drain current (continuous) at $T_C = 25\text{ }^\circ\text{C}$	80	A
$I_D$	Drain current (continuous) at $T_C = 100\text{ }^\circ\text{C}$	65	A
$I_{DM}^{(2)}$	Drain current (pulsed)	320	A
$P_{TOT}$	Total dissipation at $T_C = 25\text{ }^\circ\text{C}$	110	W
	Derating factor	0.73	W/ $^\circ\text{C}$
$dv/dt^{(3)}$	Peak diode recovery voltage slope	8	V/ns
$E_{AS}^{(4)}$	Single pulse avalanche energy	400	mJ
$T_j$ $T_{stg}$	Operating junction temperature Storage temperature	-55 to 175	$^\circ\text{C}$

- Value limited by wire bonding
- Pulse width limited by safe operating area
- $I_{SD} \leq 80\text{ A}$ ,  $di/dt \leq 40\text{ A}/\mu\text{s}$ ,  $V_{DS} \leq V_{(BR)DSS}$ ,  $T_j \leq T_{JMAX}$
- Starting  $T_j = 25\text{ }^\circ\text{C}$ ,  $I_D = 40\text{ A}$ ,  $V_{DD} = 35\text{ V}$  [Figure 16](#) and [Figure 17](#)

**Table 3. Thermal data**

Symbol	Parameter	Value	Unit
$R_{thj-case}$	Thermal resistance junction-case max	1.36	$^\circ\text{C}/\text{W}$
$R_{thj-pcb}^{(1)}$	Thermal resistance junction-pcb max	50	$^\circ\text{C}/\text{W}$

- When mounted on 1inch<sup>2</sup> FR-4 2Oz Cu board

## 2 Electrical characteristics

( $T_{CASE} = 25\text{ °C}$  unless otherwise specified)

**Table 4. On/off states**

Symbol	Parameter	Test conditions	Min.	Typ.	Max.	Unit
$V_{(BR)DSS}$	Drain-source breakdown voltage	$I_D = 250\ \mu\text{A}$ , $V_{GS} = 0$	40			V
$I_{DSS}$	Zero gate voltage drain current ( $V_{GS} = 0$ )	$V_{DS} = 40\ \text{V}$ $V_{DS} = 40\ \text{V}$ , $T_C = 125\text{ °C}$			10 100	$\mu\text{A}$ $\mu\text{A}$
$I_{GSS}$	Gate-body leakage current ( $V_{DS} = 0$ )	$V_{GS} = \pm 16\ \text{V}$			$\pm 200$	nA
$V_{GS(th)}$	Gate threshold voltage	$V_{DS} = V_{GS}$ , $I_D = 250\ \mu\text{A}$	1		2.5	V
$R_{DS(on)}$	Static drain-source on-resistance	$V_{GS} = 10\ \text{V}$ , $I_D = 40\ \text{A}$ $V_{GS} = 5\ \text{V}$ , $I_D = 40\ \text{A}$		5.0	6.0 9.0	$\text{m}\Omega$ $\text{m}\Omega$

**Table 5. Dynamic**

Symbol	Parameter	Test conditions	Min.	Typ.	Max.	Unit
$C_{iss}$	Input capacitance	$V_{DS} = 25\ \text{V}$ , $f = 1\ \text{MHz}$ , $V_{GS} = 0$	-	2500		pF
$C_{oss}$	Output capacitance			560		pF
$C_{rss}$	Reverse transfer capacitance			50		pF
$t_{d(on)}$	Turn-on delay time	$V_{DD} = 20\ \text{V}$ , $I_D = 40\ \text{A}$ $R_G = 4.7\ \Omega$ , $V_{GS} = 10\ \text{V}$ (see <a href="#">Figure 13</a> and <a href="#">Figure 18</a> )	-	7.5		ns
$t_r$	Rise time			45		ns
$t_{d(off)}$	Turn-off delay time			45		ns
$t_f$	Fall time			11		ns
$Q_g$	Total gate charge	$V_{DD} = 20\ \text{V}$ , $I_D = 80\ \text{A}$ , $V_{GS} = 10\ \text{V}$ (see <a href="#">Figure 14</a> )	-	50	70	nC
$Q_{gs}$	Gate-source charge			7		nC
$Q_{gd}$	Gate-drain charge			9.5		nC

**Table 6. Source drain diode**

Symbol	Parameter	Test conditions	Min.	Typ.	Max.	Unit
$I_{SD}$ $I_{SDM}^{(1)}$	Source-drain current Source-drain current (pulsed)		-		80 320	A A
$V_{SD}^{(2)}$	Forward on voltage	$I_{SD} = 80\text{ A}$ , $V_{GS} = 0$	-		1.5	V
$t_{rr}$ $Q_{rr}$ $I_{RRM}$	Reverse recovery time Reverse recovery charge Reverse recovery current	$I_{SD} = 80\text{ A}$ , $di/dt = 100\text{ A}/\mu\text{s}$ , $V_{DD} = 20\text{ V}$ , $T_j = 150\text{ }^\circ\text{C}$ (see <a href="#">Figure 15</a> and <a href="#">Figure 19</a> )	-	40 55 3		ns nC A

1. Pulse width limited by safe operating area.
2. Pulsed: Pulse duration = 300  $\mu\text{s}$ , duty cycle 1.5%

## 2.1 Electrical characteristics (curves)

Figure 2. Safe operating area

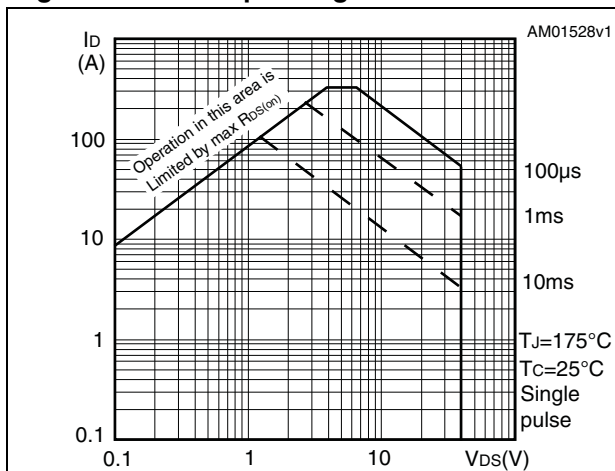

Figure 3. Thermal impedance

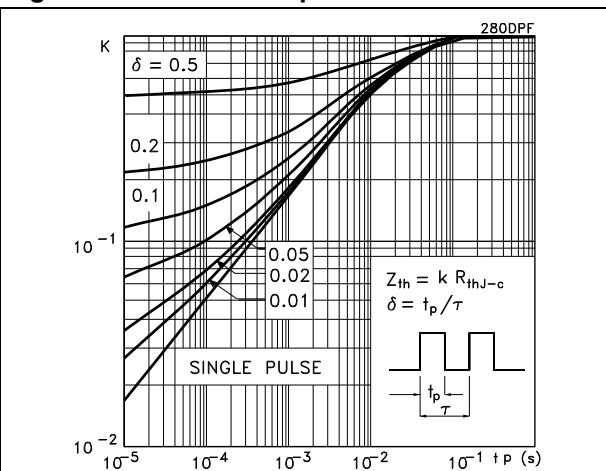

Figure 4. Output characteristics

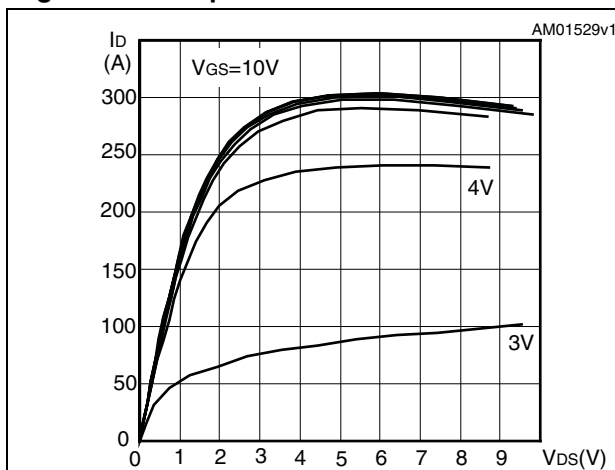

Figure 5. Transfer characteristics

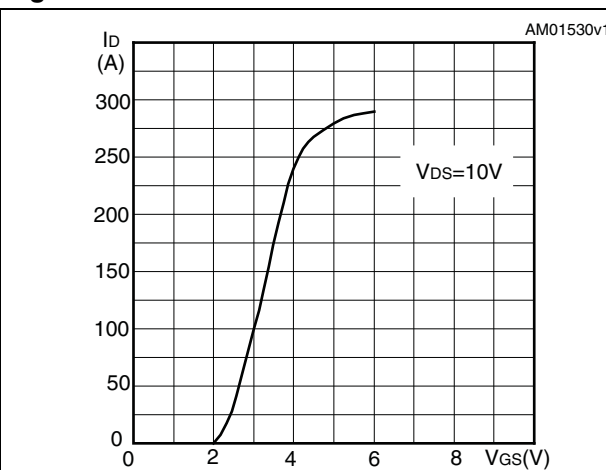

Figure 6. Static drain-source on-resistance

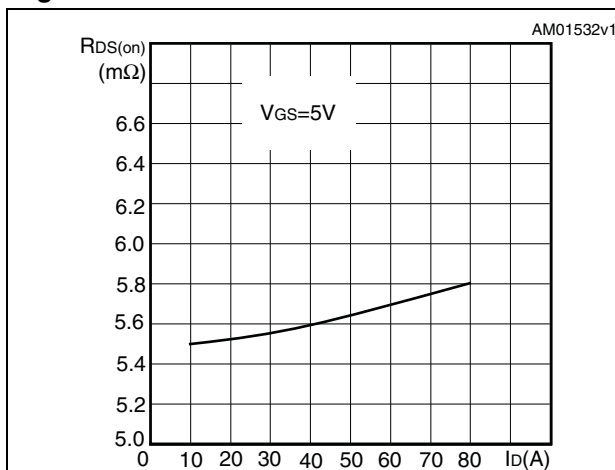

Figure 7. Normalized BV<sub>DSS</sub> vs temperature

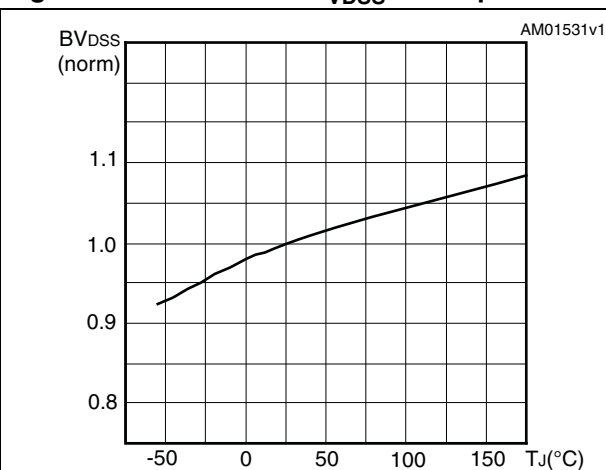

Figure 8. Gate charge vs gate-source voltage Figure 9. Capacitance variations

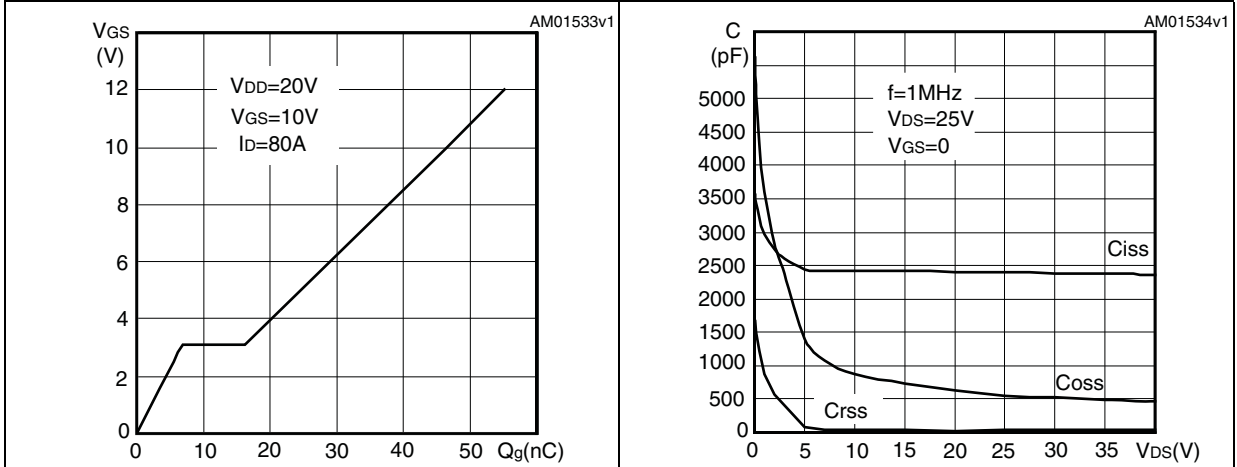

Figure 10. Normalized gate threshold voltage vs temperature Figure 11. Normalized on resistance vs temperature

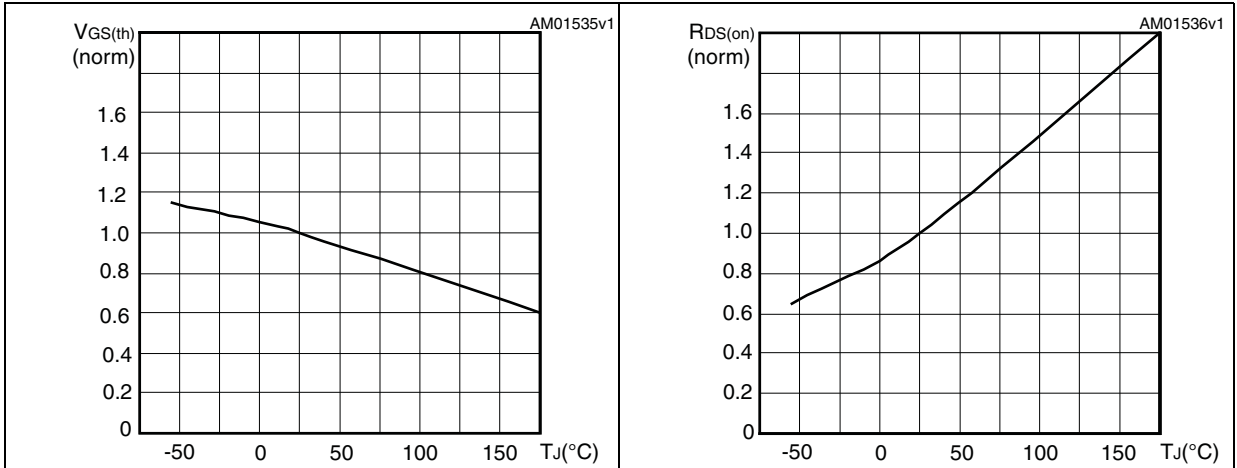
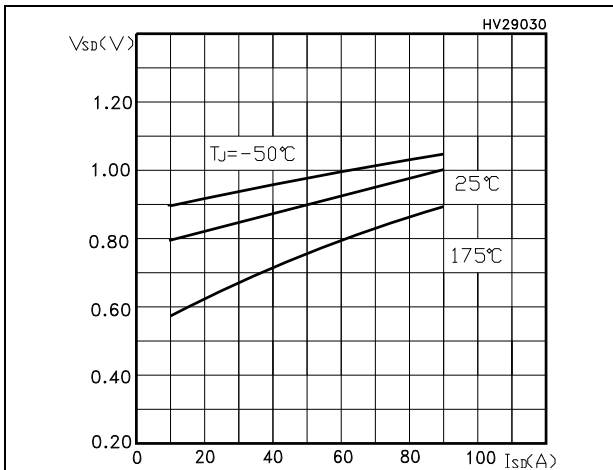

Figure 12. Source-drain diode forward characteristics



### 3 Test circuits

**Figure 13. Switching times test circuit for resistive load**



AM01468v1

**Figure 14. Gate charge test circuit**



AM01469v1

**Figure 15. Test circuit for inductive load switching and diode recovery times**



AM01470v1

**Figure 16. Unclamped inductive load test circuit**



AM01471v1

**Figure 17. Unclamped inductive waveform**

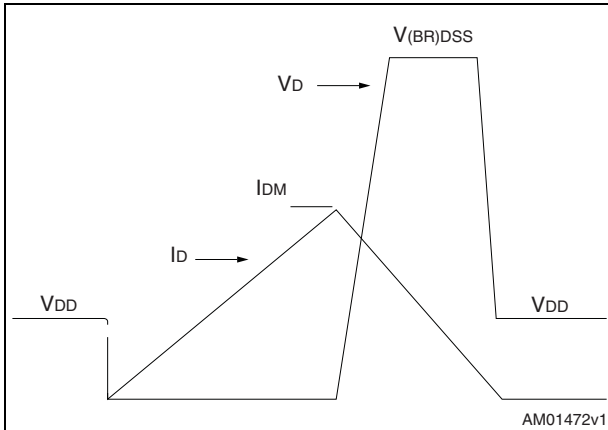

AM01472v1

**Figure 18. Switching time waveform**

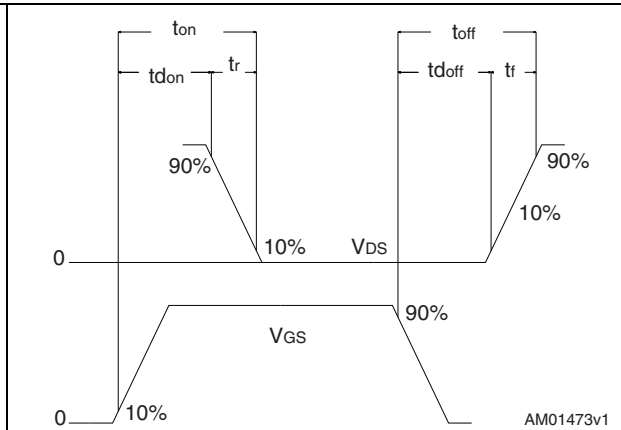

AM01473v1



Figure 19. Diode reverse recovery waveform

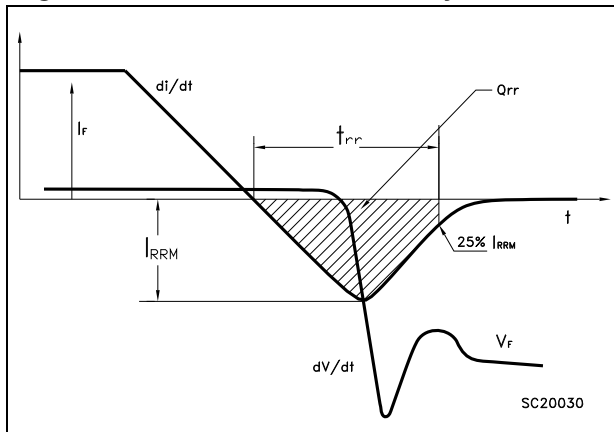

## 4 Package mechanical data

In order to meet environmental requirements, ST offers these devices in different grades of ECOPACK<sup>®</sup> packages, depending on their level of environmental compliance. ECOPACK<sup>®</sup> specifications, grade definitions and product status are available at: [www.st.com](http://www.st.com). ECOPACK is an ST trademark.

**Table 7. DPAK (TO-252) mechanical data**

Dim.	mm		
	Min.	Typ.	Max.
A	2.20		2.40
A1	0.90		1.10
A2	0.03		0.23
b	0.64		0.90
b4	5.20		5.40
c	0.45		0.60
c2	0.48		0.60
D	6.00		6.20
D1		5.10	
E	6.40		6.60
E1		4.70	
e		2.28	
e1	4.40		4.60
H	9.35		10.10
L	1		
L1		2.80	
L2		0.80	
L4	0.60		1
R		0.20	
V2	0°		8°

Figure 20. DPAK (TO-252) drawing

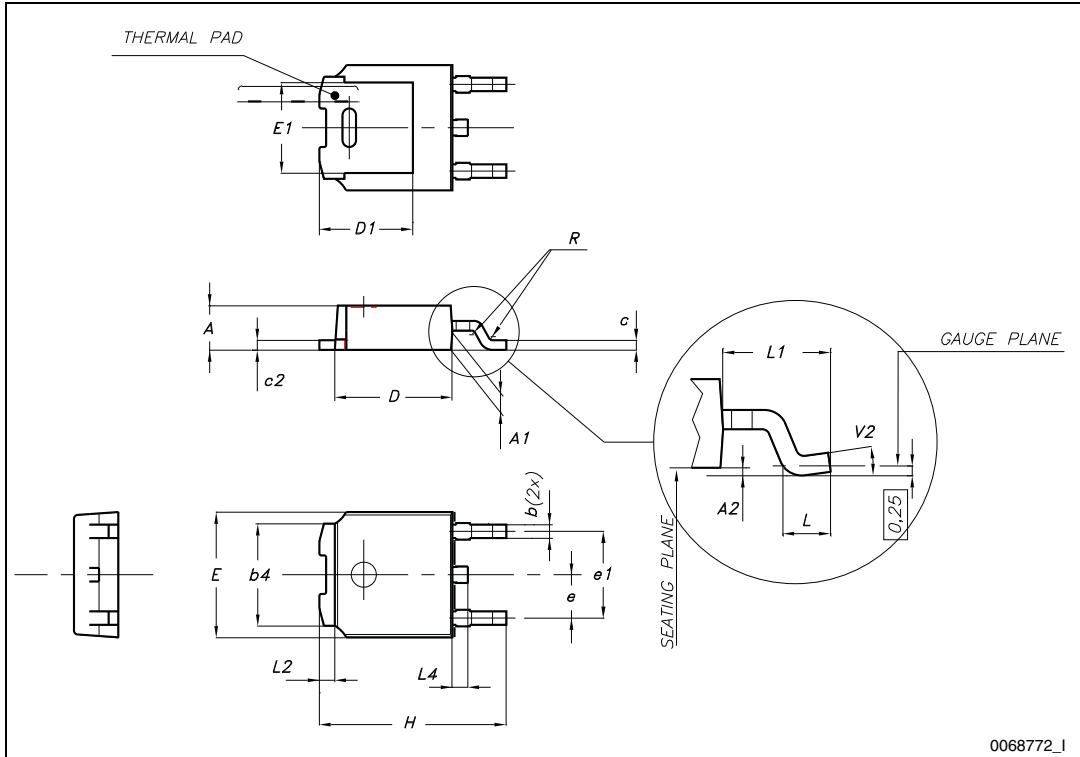
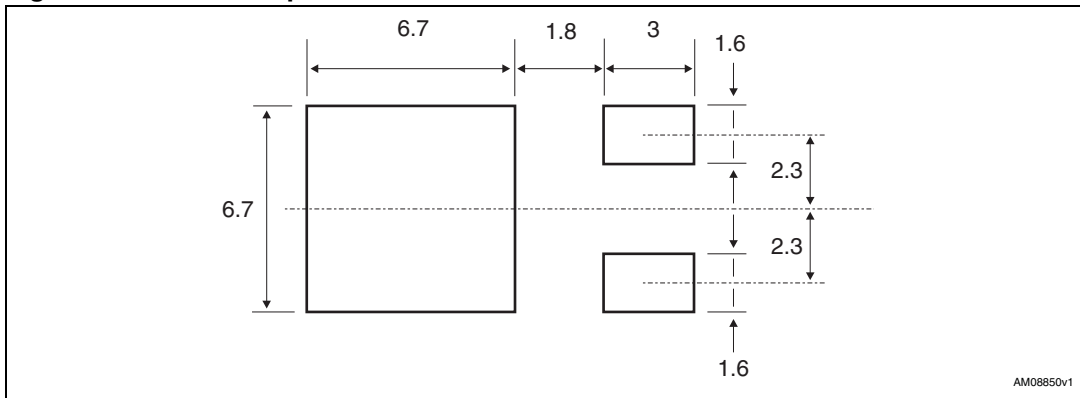

Figure 21. DPAK footprint<sup>(a)</sup>



a. All dimensions are in millimeters

## 5 Packing mechanical data

**Table 8. DPAK (TO-252) tape and reel mechanical data**

Tape			Reel		
Dim.	mm		Dim.	mm	
	Min.	Max.		Min.	Max.
A0	6.8	7	A		330
B0	10.4	10.6	B	1.5	
B1		12.1	C	12.8	13.2
D	1.5	1.6	D	20.2	
D1	1.5		G	16.4	18.4
E	1.65	1.85	N	50	
F	7.4	7.6	T		22.4
K0	2.55	2.75			
P0	3.9	4.1	Base qty.		2500
P1	7.9	8.1	Bulk qty.		2500
P2	1.9	2.1			
R	40				
T	0.25	0.35			
W	15.7	16.3			

Figure 22. Tape for DPAK (TO-252)

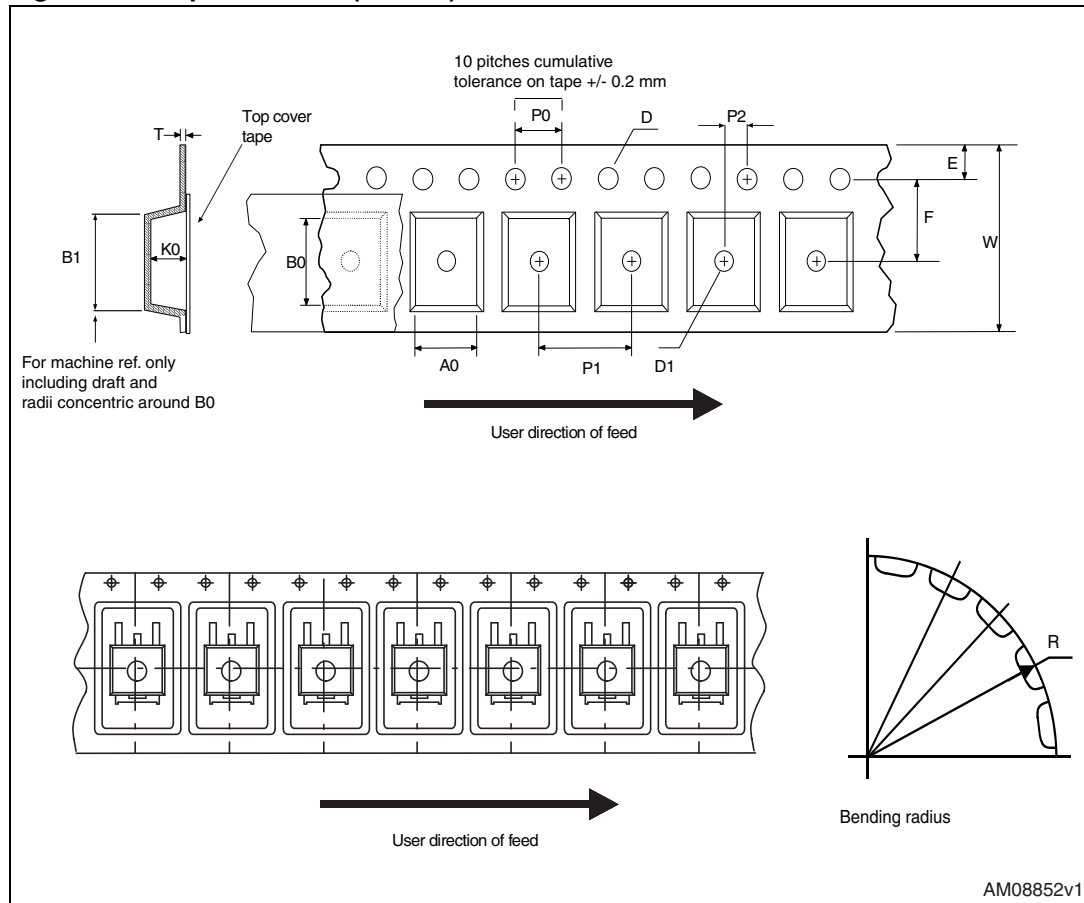
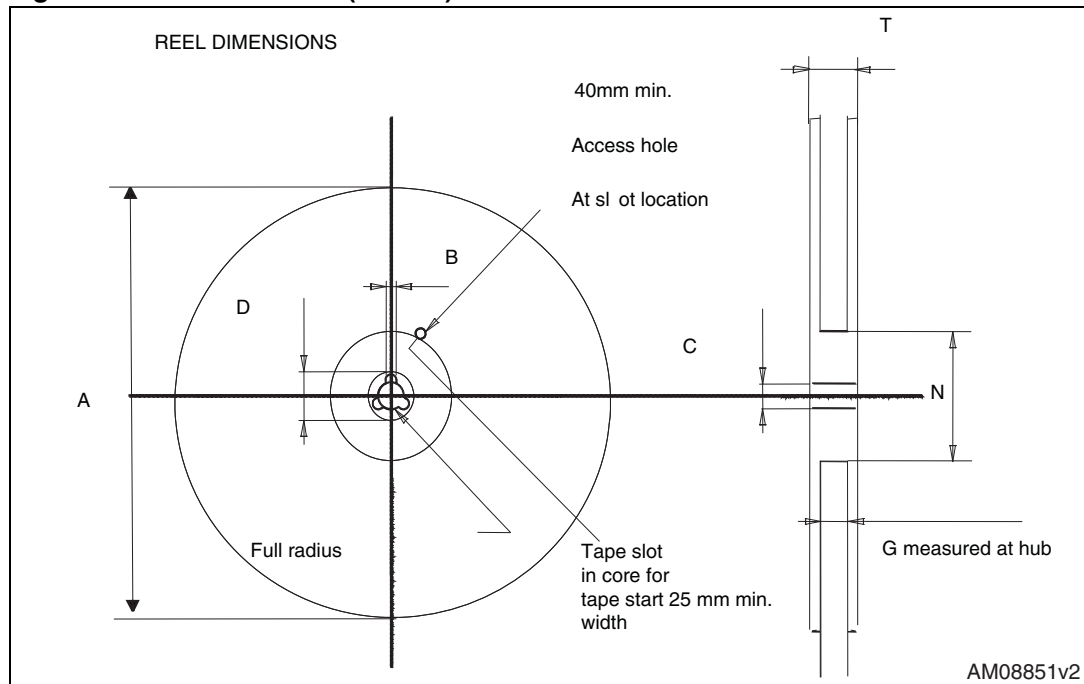

Figure 23. Reel for DPAK (TO-252)



## 6 Revision history

**Table 9. Document revision history**

Date	Revision	Changes
11-Feb-2009	1	First release
23-Jul-2009	2	Marking on device summary has been corrected.
13-Jul-2012	3	Updated title on the cover page. Minor text changes. Updated <i>Section 4: Package mechanical data</i> and <i>Section 5: Packing mechanical data</i> .

**Please Read Carefully:**

Information in this document is provided solely in connection with ST products. STMicroelectronics NV and its subsidiaries ("ST") reserve the right to make changes, corrections, modifications or improvements, to this document, and the products and services described herein at any time, without notice.

All ST products are sold pursuant to ST's terms and conditions of sale.

Purchasers are solely responsible for the choice, selection and use of the ST products and services described herein, and ST assumes no liability whatsoever relating to the choice, selection or use of the ST products and services described herein.

No license, express or implied, by estoppel or otherwise, to any intellectual property rights is granted under this document. If any part of this document refers to any third party products or services it shall not be deemed a license grant by ST for the use of such third party products or services, or any intellectual property contained therein or considered as a warranty covering the use in any manner whatsoever of such third party products or services or any intellectual property contained therein.

**UNLESS OTHERWISE SET FORTH IN ST'S TERMS AND CONDITIONS OF SALE ST DISCLAIMS ANY EXPRESS OR IMPLIED WARRANTY WITH RESPECT TO THE USE AND/OR SALE OF ST PRODUCTS INCLUDING WITHOUT LIMITATION IMPLIED WARRANTIES OF MERCHANTABILITY, FITNESS FOR A PARTICULAR PURPOSE (AND THEIR EQUIVALENTS UNDER THE LAWS OF ANY JURISDICTION), OR INFRINGEMENT OF ANY PATENT, COPYRIGHT OR OTHER INTELLECTUAL PROPERTY RIGHT.**

**UNLESS EXPRESSLY APPROVED IN WRITING BY TWO AUTHORIZED ST REPRESENTATIVES, ST PRODUCTS ARE NOT RECOMMENDED, AUTHORIZED OR WARRANTED FOR USE IN MILITARY, AIR CRAFT, SPACE, LIFE SAVING, OR LIFE SUSTAINING APPLICATIONS, NOR IN PRODUCTS OR SYSTEMS WHERE FAILURE OR MALFUNCTION MAY RESULT IN PERSONAL INJURY, DEATH, OR SEVERE PROPERTY OR ENVIRONMENTAL DAMAGE. ST PRODUCTS WHICH ARE NOT SPECIFIED AS "AUTOMOTIVE GRADE" MAY ONLY BE USED IN AUTOMOTIVE APPLICATIONS AT USER'S OWN RISK.**

Resale of ST products with provisions different from the statements and/or technical features set forth in this document shall immediately void any warranty granted by ST for the ST product or service described herein and shall not create or extend in any manner whatsoever, any liability of ST.

ST and the ST logo are trademarks or registered trademarks of ST in various countries.

Information in this document supersedes and replaces all information previously supplied.

The ST logo is a registered trademark of STMicroelectronics. All other names are the property of their respective owners.

© 2012 STMicroelectronics - All rights reserved

STMicroelectronics group of companies

Australia - Belgium - Brazil - Canada - China - Czech Republic - Finland - France - Germany - Hong Kong - India - Israel - Italy - Japan - Malaysia - Malta - Morocco - Philippines - Singapore - Spain - Sweden - Switzerland - United Kingdom - United States of America

[www.st.com](http://www.st.com)

