

# CGHV96050F1

50 W, 7.9 - 9.6 GHz, 50-ohm, Input/Output Matched GaN HEMT

## Description

Cree's CGHV96050F1 is a gallium nitride (GaN) High Electron Mobility Transistor (HEMT) on Silicon Carbide (SiC) substrates. This GaN Internally Matched (IM) FET offers excellent power added efficiency in comparison to other technologies. GaN has superior properties compared to silicon or gallium arsenide, including higher breakdown voltage, higher saturated electron drift velocity and higher thermal conductivity. GaN HEMTs also offer greater power density and wider bandwidths compared to GaAs transistors. This IM FET is available in a metal/ceramic flanged package for optimal electrical and thermal performance.

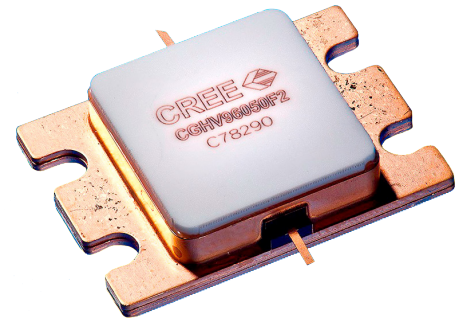

PN: CGHV96050F1  
Package Type: 440210

## Typical Performance Over 7.9 - 8.4 GHz ( $T_c = 25^\circ\text{C}$ )

Parameter	7.9 GHz	8.0 GHz	8.1 GHz	8.2 GHz	8.3 GHz	8.4 GHz	Units
Linear Gain	17.0	16.7	16.4	15.9	15.2	14.6	dB
Output Power	22.4	28.2	28.2	31.6	31.6	31.6	W
Power Gain	15.6	15.0	15.1	14.5	14.0	13.2	dB
Power Added Efficiency	30	37	37	39	38	37	%

Note: Measured at -30 dBc, 1.6 MHz from carrier, in the CGHV96050F1-AMP (838176) under OQPSK modulation, 1.6 Msps, PN23, Alpha Filter = 0.2

### Features

- 7.9 - 8.4 GHz Operation
- 80 W  $P_{OUT}$  typical
- >13 dB Power Gain
- 33% Typical PAE
- 50 Ohm Internally Matched
- <0.1 dB Power Droop

### Applications

- Satellite Communication
- Terrestrial Broadband



### Absolute Maximum Ratings (not simultaneous)

Parameter	Symbol	Rating	Units	Conditions
Drain-source Voltage	$V_{DS}$	100	Volts	25 °C
Gate-source Voltage	$V_{GS}$	-10, +2	Volts	25 °C
Power Dissipation	$P_{DISS}$	57.6 / 86.4	Watts	(CW / Pulse)
Storage Temperature	$T_{STG}$	-65, +150	°C	
Operating Junction Temperature	$T_J$	225	°C	
Maximum Drain Current <sup>1</sup>	$I_{DMAX}$	6	Amps	
Maximum Forward Gate Current	$I_{GMAX}$	14.4	mA	25 °C
Soldering Temperature <sup>2</sup>	$T_S$	245	°C	
Screw Torque	$\tau$	40	in-oz	
Thermal Resistance, Junction to Case	$R_{\theta JC}$	1.26	°C/W	Pulse Width = 100 $\mu$ s, Duty Cycle = 10%, $P_{DISS} = 86.4$ W
Thermal Resistance, Junction to Case	$R_{\theta JC}$	2.16	°C/W	CW, 85 °C, $P_{DISS} = 57.6$ W
Case Operating Temperature <sup>3</sup>	$T_C$	-40, +150	°C	

Notes:

<sup>1</sup> Current limit for long term, reliable operation

<sup>2</sup> Refer to the Application Note on soldering at [wolfspeed.com/rf/document-library](http://wolfspeed.com/rf/document-library)

<sup>3</sup> See also, the Power Dissipation De-rating Curve on Page 10

### Electrical Characteristics (Frequency = 7.9 - 8.4 GHz unless otherwise stated; $T_C = 25$ °C)

Characteristics	Symbol	Min.	Typ.	Max.	Units	Conditions
<b>DC Characteristics<sup>1</sup></b>						
Gate Threshold Voltage	$V_{GS(TH)}$	-3.8	-3.0	-2.3	V	$V_{DS} = 10$ V, $I_D = 14.4$ mA
Gate Quiescent Voltage	$V_Q$	-	-3.0	-	V	$V_{DS} = 40$ V, $I_D = 500$ mA
Saturated Drain Current <sup>2</sup>	$I_{DS}$	11.5	13.0	-	A	$V_{DS} = 6.0$ V, $V_{GS} = 2.0$ V
Drain-Source Breakdown Voltage	$V_{BD}$	100	-	-	V	$V_{GS} = -8$ V, $I_D = 14.4$ mA
<b>RF Characteristics<sup>3</sup></b>						
Small Signal Gain	S21	13.25	16	-	dB	$V_{DD} = 40$ V, $I_{DQ} = 500$ mA, $P_{IN} = -20$ dBm
Input Return Loss	S11	-	-4.9	-3.0	dB	$V_{DD} = 40$ V, $I_{DQ} = 500$ mA, $P_{IN} = -20$ dBm
Output Return Loss	S22	-	-10.7	-5.5	dB	$V_{DD} = 40$ V, $I_{DQ} = 500$ mA, $P_{IN} = -20$ dBm
Power Gain <sup>3,4</sup>	$P_{G1}$	10.75	15.6	-	dB	$V_{DD} = 40$ V, $I_{DQ} = 500$ mA, $P_{OUT} = 44$ dBm, Freq. = 7.9 GHz
Power Gain <sup>3,4</sup>	$P_{G2}$	10.75	13.5	-	dB	$V_{DD} = 40$ V, $I_{DQ} = 500$ mA, $P_{OUT} = 44$ dBm, Freq. = 8.4 GHz
Power Added Efficiency <sup>3,4</sup>	$PAE_1$	18	25	-	%	$V_{DD} = 40$ V, $I_{DQ} = 500$ mA, $P_{OUT} = 44$ dBm, Freq. = 7.9 GHz
Power Added Efficiency <sup>3,4</sup>	$PAE_2$	18	27	-	%	$V_{DD} = 40$ V, $I_{DQ} = 500$ mA, $P_{OUT} = 44$ dBm, Freq. = 8.4 GHz
OQPSK Linearity <sup>3,4</sup>	$ACLR_1$	-	-	-26	dBc	$V_{DD} = 40$ V, $I_{DQ} = 500$ mA, $P_{OUT} = 44$ dBm, Freq. = 7.9 GHz
OQPSK Linearity <sup>3,4</sup>	$ACLR_2$	-	-	-26	dBc	$V_{DD} = 40$ V, $I_{DQ} = 500$ mA, $P_{OUT} = 44$ dBm, Freq. = 8.4 GHz
Output Mismatch Stress	VSWR	-	5:1	-	$\Psi$	No damage at all phase angles, $V_{DD} = 40$ V, $I_{DQ} = 500$ mA

Notes:

<sup>1</sup> Measured on wafer prior to packaging

<sup>2</sup> Scaled from PCM data

<sup>3</sup> Measured at -30 dBc, 1.6 MHz from carrier, in the CGHV96050F1-AMP (838176) under OQPSK modulation, 1.6 Msps, PN23, Alpha: Filter = 0.2

<sup>4</sup> Fixture loss de-embedded using the following offsets: At 7.9 GHz, input and output = 0.45 dB. At 8.4 GHz, input = 0.50 dB and output = 0.55 dB



**CGHV96050F1 Typical Performance**

**Figure 1. Small Signal Gain and Return Loss vs Frequency of CGHV96050F1 measured in CGHV96050F1-AMP**  
 $V_{DS} = 40\text{ V}, I_{DQ} = 500\text{ mA}$

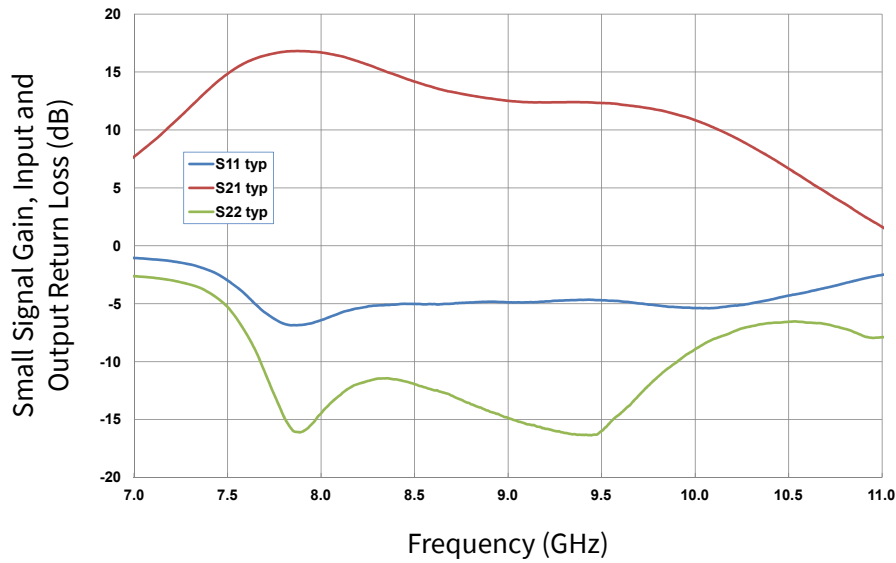

**Figure 2. Intermodulation Distortion Performance vs. Tone Spacing**  
 $V_{DD} = 40\text{ V}, \text{Frequency} = 8.2\text{ GHz}, \text{Output Power} = 44\text{ dBm} / 20\text{ W}$

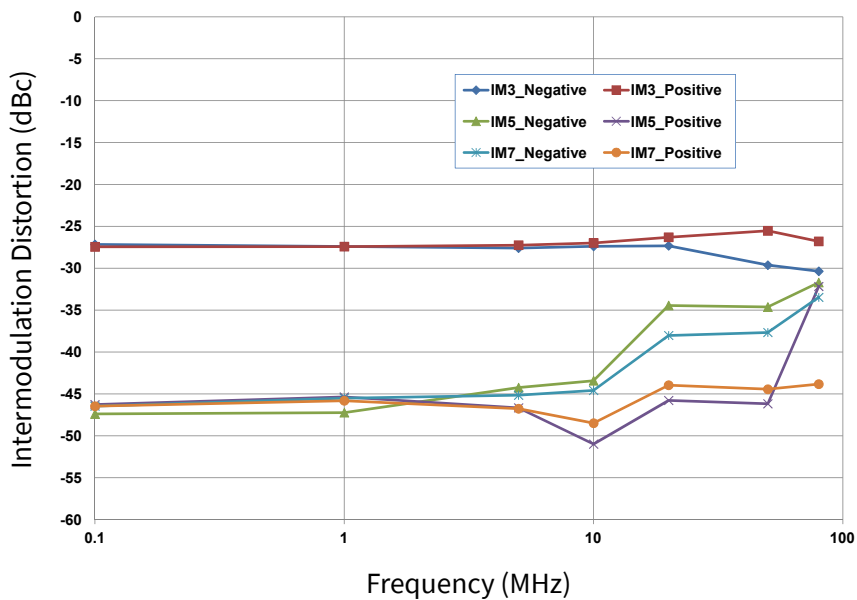



### CGHV96050F1 Typical Performance

**Figure 3. IM3 and IM5 vs. Output Power at 7.9 GHz, 8.2 GHz, and 8.4 GHz**  
 $V_{DD} = 40\text{ V}$ , Tone Spacing = 100 kHz

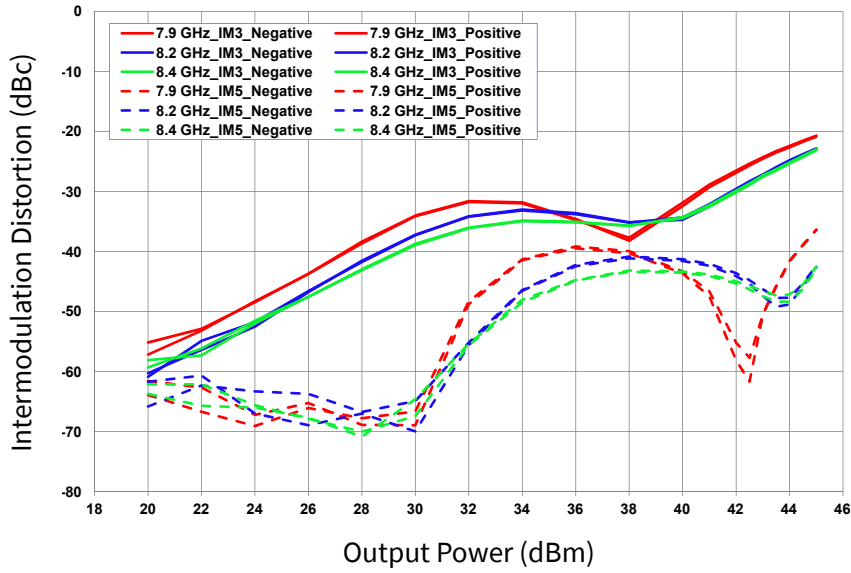

**Figure 4. Two Tone IMS vs. Output Power**  
 $V_{DD} = 40\text{ V}$ , Tone Spacing = 100 kHz

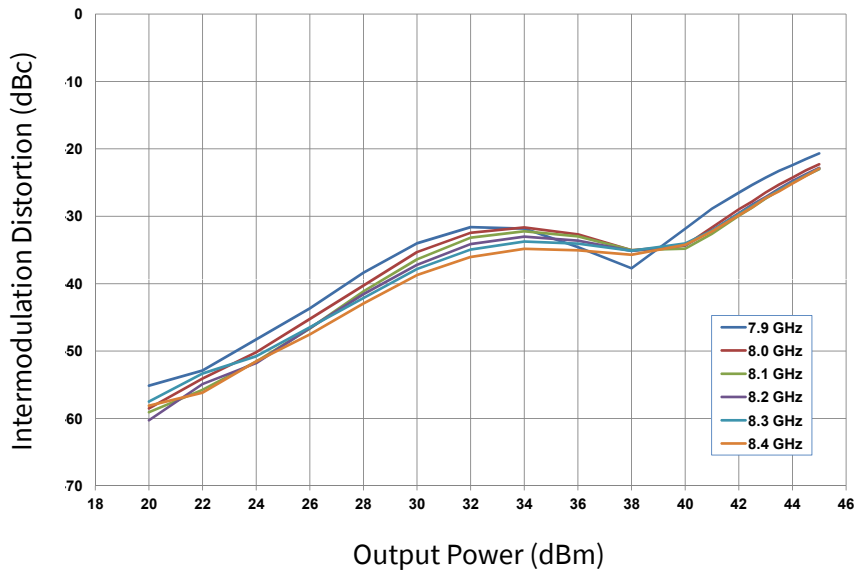



### CGHV96050F1 Typical Performance

**Figure 5. Two Tone Power Added Efficiency vs. Output Power**  
 $V_{DD} = 40\text{ V}$ , Tone Spacing = 100 kHz

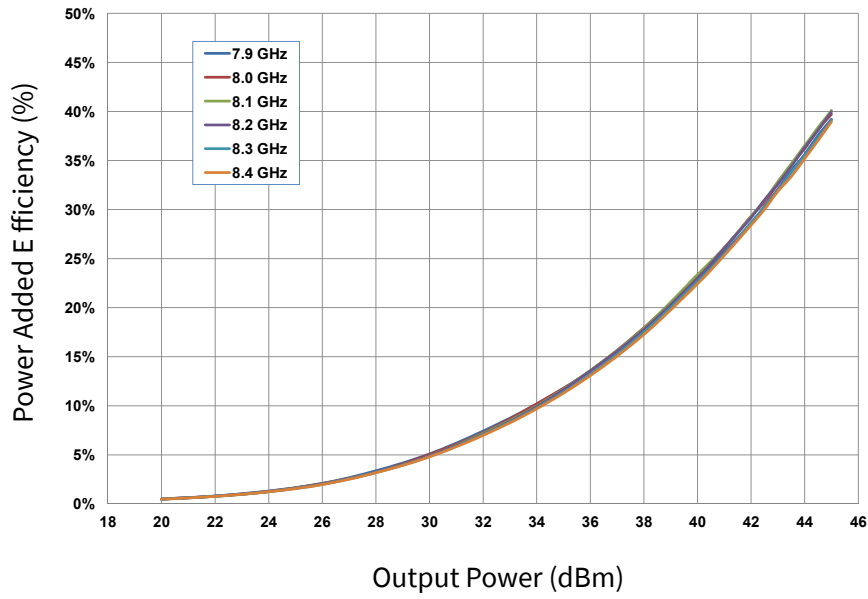

**Figure 6. Two Tone Gain vs. Output Power**  
 $V_{DD} = 40\text{ V}$ , Tone Spacing = 100 kHz

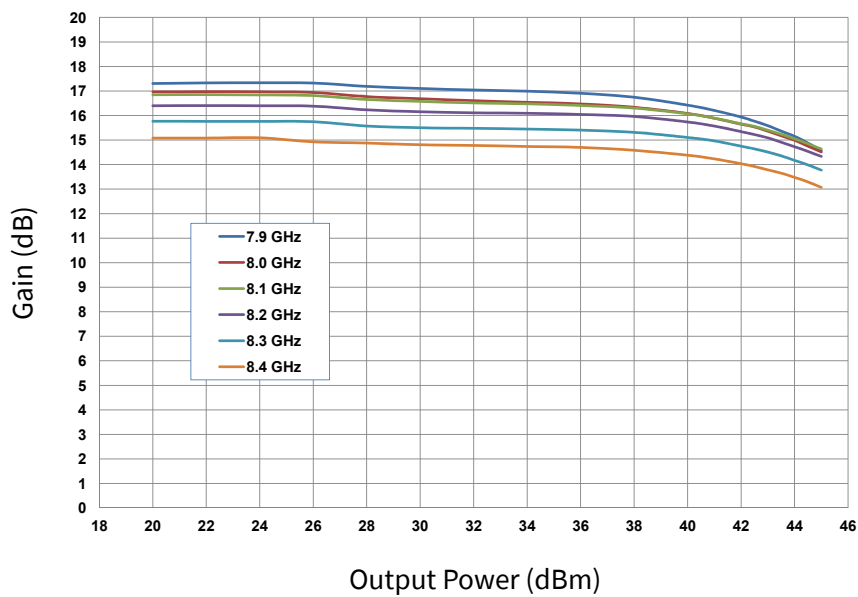



**CGHV96050F1 Typical Performance**

**Figure 7. Spectral Mask under OQPSK Modulation, 1.6 Msps**  
 $V_{DD} = 40\text{ V}$ , Output Power = 44 dBm / 25 W

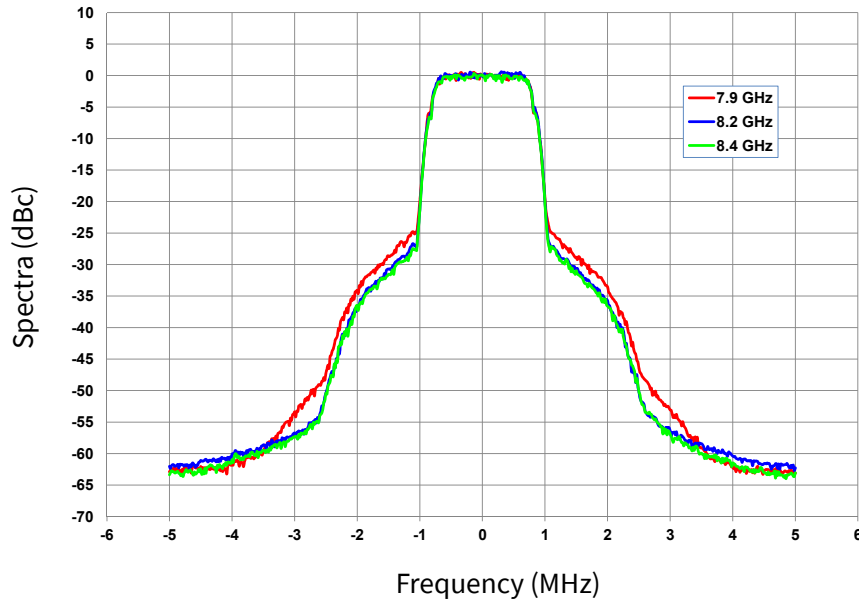

**Figure 8. Linear Output Power, Gain, and Power Added Efficiency vs Frequency**  
 $V_{DD} = 40\text{ V}$ ,  $I_{DQ} = 500\text{ mA}$ , 1.6 Msps, OQPSK Modulation at -30 dBc

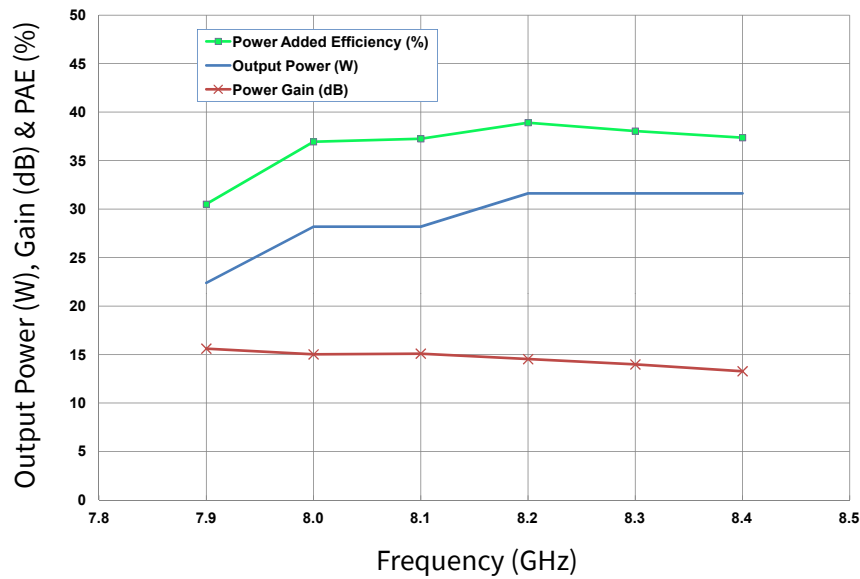



CGHV96050F1 Typical Performance

Figure 9. OQPSK Linearity vs Output Power  
 $V_{DD} = 40\text{ V}$ , Frequency = 1.6 MHz

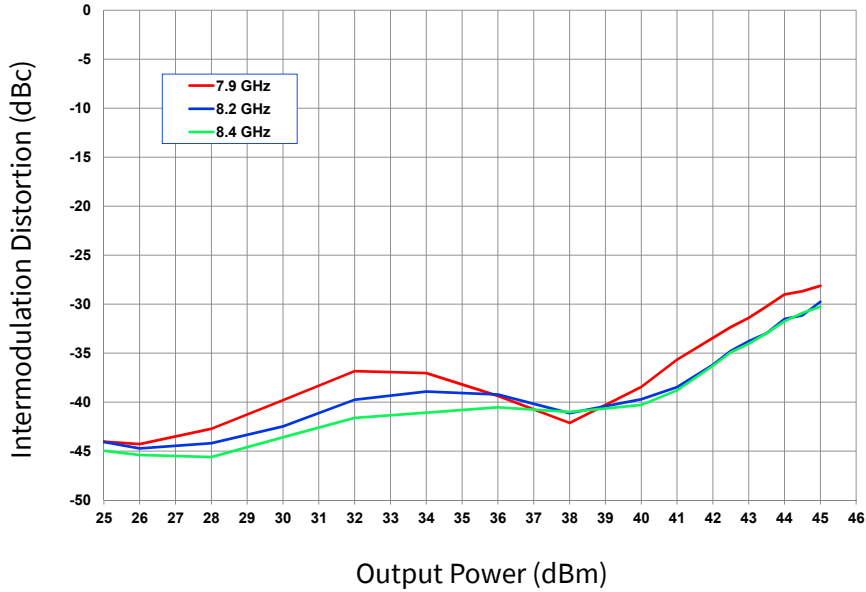
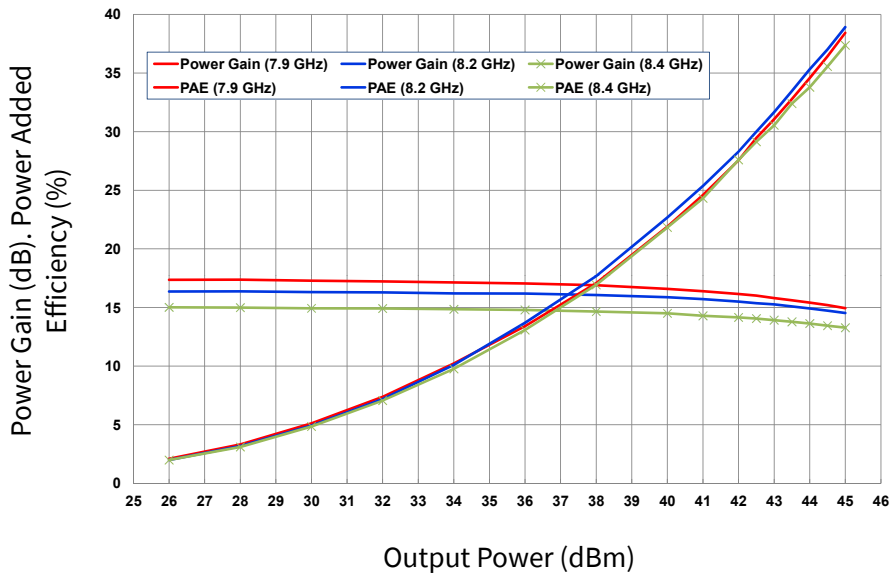

Figure 10. Power Gain and Power Added Efficiency vs Output Power  
 $V_{DD} = 40\text{ V}$ ,  $I_{DQ} = 500\text{ mA}$ , 1.6 Msps, OQPSK Modulation at -30 dBc



## CGHV96050F1-AMP Demonstration Amplifier Circuit Bill of Materials

Designator	Description	Qty
R1	RES, 47 OHM,+/-1%, 1/16 W, 0603, SMD	1
R2, R3	RES, 0 OHM +/-5%, 125 mW, 1206, SMD	2
C1	CAP, 1.6pF, +/- 0.1 pF, 200V, 0402, ATC 600L	1
C2	CAP, 1.0pF, +/- 0.1 pF, 200V, 0402, ATC 600L	1
C3, C13	CAP, 10 pF +/-5%, 0603, ATC	2
C4, C14	CAP, 470 pF +/-5%, 100 V, 0603	2
C5, C15	CAP, 33,000 pF, 0805, 100 V, X7R	2
C11, C12	CAP, 1.8pF, +/- 0.1 pF, 200V, 0402, ATC 600L	2
C16	CAP, 1 uF +/-10%, 100 V, X7P, 1210	1
C17	CAP, 33 uF +/-20%, G-CASE	1
C18	CAP, 470 uF, +/-20%, ELECTROLYTIC	1
J1,J2	CONNECTOR, SMA, PANEL MOUNT JACK, FLANGE, 4-HOLE, BLUNT POST, 20MIL	2
J3	CONNECTOR, HEADER, RT>PLZ .1CEN LK 9POS	1
-	PCB, TEST FIXTURE, TACONICS RF35P, 20 MIL THK, 440210 PKG	1
-	2-56 SOC HD SCREW 1/4 SS	4
-	#2 SPLIT LOCKWASHER SS	4
Q1	CGHV96050F1	1

## CGHV96050F1-AMP Demonstration Amplifier Circuit

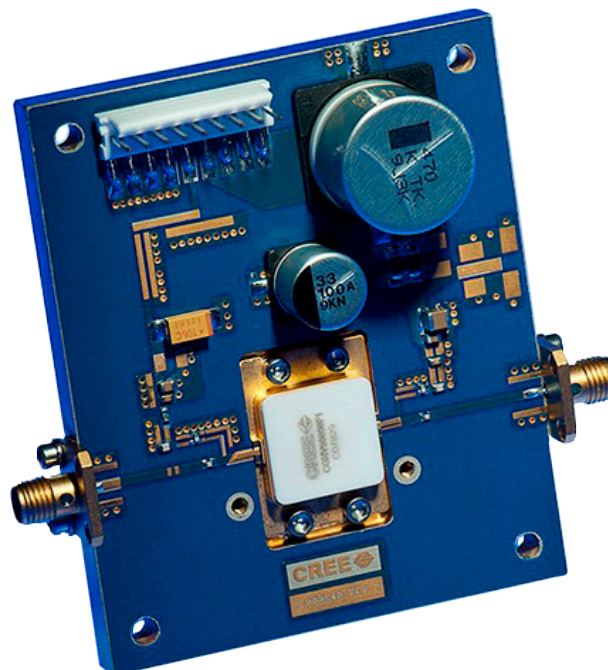





**CGHV96050F1-AMP Demonstration Amplifier Circuit Schematic**

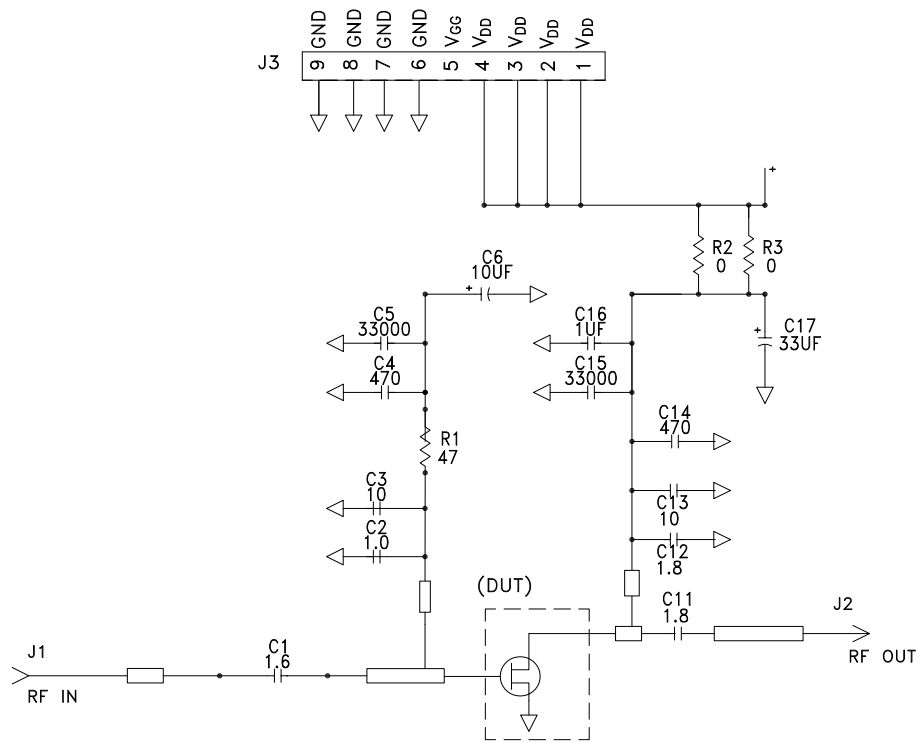

**CGHV96050F1-AMP Demonstration Amplifier Circuit Outline**

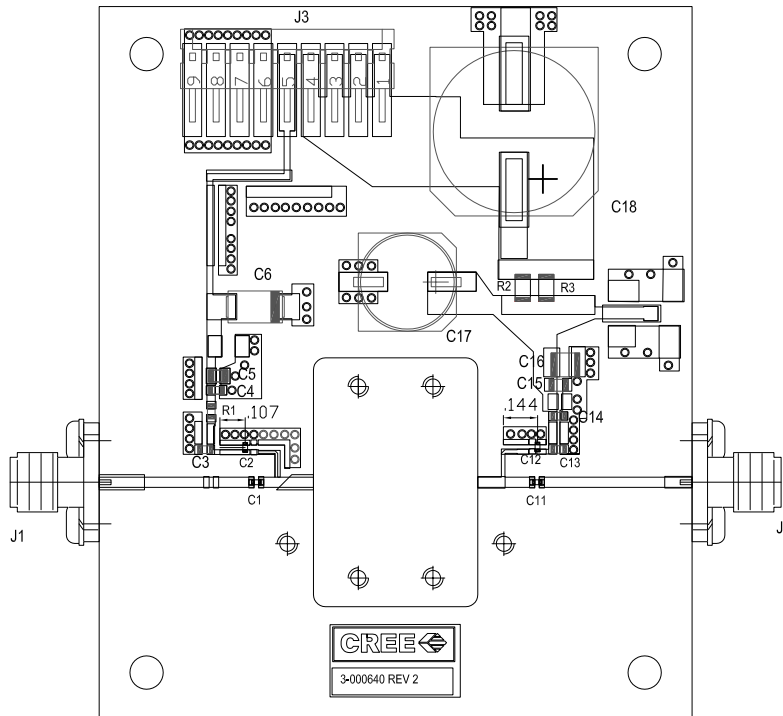

**CGHV96050F1 Power Dissipation De-rating Curve**

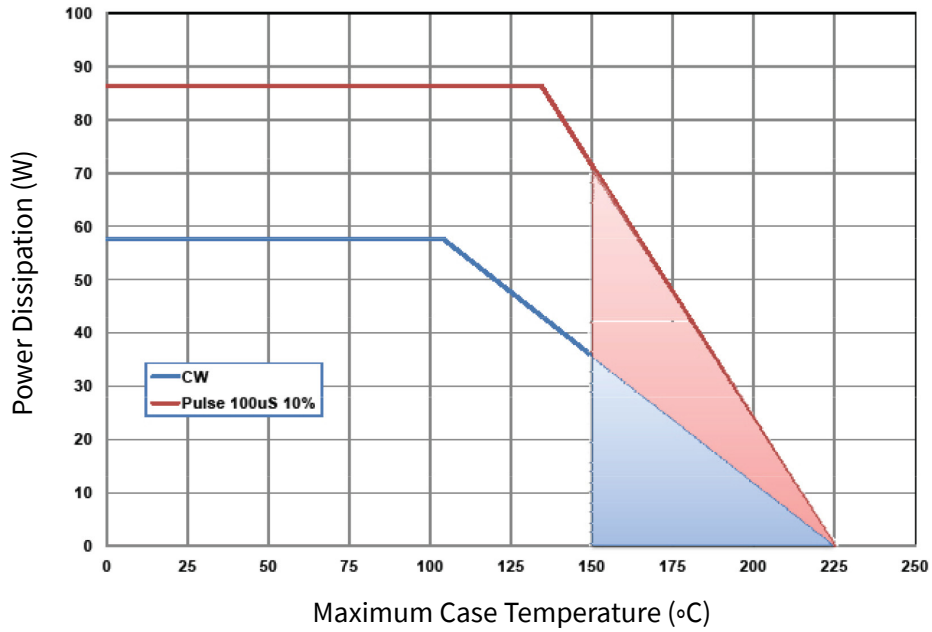

Note. Area exceeds Maximum Case Temperature (See Page 2)

**Electrostatic Discharge (ESD) Classifications**

Parameter	Symbol	Class	Test Methodology
Human Body Model	HBM	1A > 250 V	JEDEC JESD22 A114-D
Charge Device Model	CDM	II < 200 V	JEDEC JESD22 C101-C

**Product Dimensions CGHV96050F1 (Package Type — 440210)**

- NOTES: (UNLESS OTHERWISE SPECIFIED)
1. INTERPRET DRAWING IN ACCORDANCE WITH ANSI Y14.5M-2009
  2. ADHESIVE FROM LID MAY EXTEND A MAXIMUM OF .020 BEYOND EDGE OF LID
  3. LID MAY BE MISALIGNED TO THE BODY OF PACKAGE BY A MAXIMUM OF .008 IN ANY DIRECTION
  4. ALL PLATED SURFACES ARE GOLD OVER NICKEL

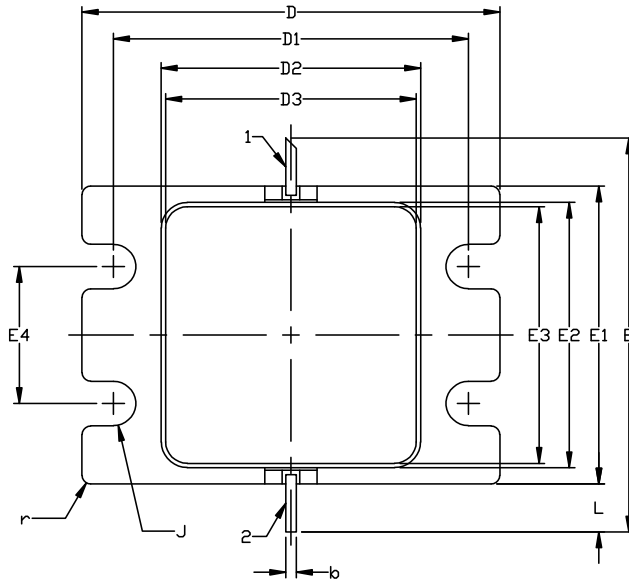

1. GATE  
2. DRAIN

0.002

DIM	INCHES		MILLIMETERS		NOTES
	MIN	MAX	MIN	MAX	
A	0.188	0.198	4.78	5.03	
A1	0.088	0.100	2.24	2.54	2x
A2	0.049	0.061	1.24	1.55	
b	0.022	0.026	0.56	0.66	2x
c	0.002	0.006	0.05	0.15	
D	0.935	0.955	23.75	24.26	
D1	0.797	0.809	20.24	20.55	2x
D2	0.581	0.593	14.76	15.06	
D3	0.563	0.571	14.30	14.50	
E	0.906		23.01		REF
E1	0.679	0.691	17.25	17.55	
E2	0.604	0.616	15.34	15.65	
E3	0.586	0.594	14.88	15.09	
E4	0.309	0.321	7.85	8.15	2x
J	∅0.097	∅0.107	∅2.46	∅2.72	4x
L	0.090	0.130	2.29	3.30	2x
r	0.02 TYP		0.51 TYP		12x

A, A1, A2, b, c, L, r



**Part Number System**

**CGHV96050F1**

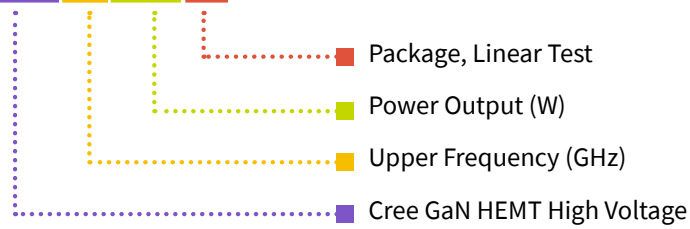

**Table 1.**

Parameter	Value	Units
Upper Frequency <sup>1</sup>	9.6	GHz
Power Output	50	W
Package	Flange	-

**Note<sup>1</sup>:** Alpha characters used in frequency code indicate a value greater than 9.9 GHz. See Table 2 for value.

**Table 2.**

Character Code	Code Value
A	0
B	1
C	2
D	3
E	4
F	5
G	6
H	7
J	8
K	9
Examples:	1A = 10.0 GHz 2H = 27.0 GHz

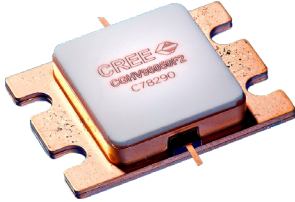
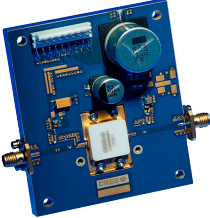

**Product Ordering Information**

Order Number	Description	Unit of Measure	Image
CGHV96050F1	GaN HEMT	Each	
CGHV96050F1-AMP	Test board with GaN HEMT installed	Each	



For more information, please contact:

4600 Silicon Drive  
Durham, North Carolina, USA 27703  
[www.wolfspeed.com/RF](http://www.wolfspeed.com/RF)

Sales Contact  
[RFSales@wolfspeed.com](mailto:RFSales@wolfspeed.com)

RF Product Marketing Contact  
[RFMarketing@wolfspeed.com](mailto:RFMarketing@wolfspeed.com)

## Notes

---

### Disclaimer

Specifications are subject to change without notice. Cree, Inc. believes the information contained within this data sheet to be accurate and reliable. However, no responsibility is assumed by Cree for any infringement of patents or other rights of third parties which may result from its use. No license is granted by implication or otherwise under any patent or patent rights of Cree. Cree makes no warranty, representation or guarantee regarding the suitability of its products for any particular purpose. “Typical” parameters are the average values expected by Cree in large quantities and are provided for information purposes only. These values can and do vary in different applications and actual performance can vary over time. All operating parameters should be validated by customer’s technical experts for each application. Cree products are not designed, intended or authorized for use as components in applications intended for surgical implant into the body or to support or sustain life, in applications in which the failure of the Cree product could result in personal injury or death or in applications for planning, construction, maintenance or direct operation of a nuclear facility.