

FEATURES

- Universal AC/DC wide voltage timer
- 6 Timing modes
- Time range 0.1 second – 10 hours. 6 time ranges available
- Output indicator: Red LED
- Simple timing mode and time range settings by rotary switches
- DIN rail mounting
- UL and CE approvals, RoHS compliant



11/14/14

SPECIFICATIONS

- Operating modes ..... 6
- Input terminals ..... A1-A2
- Input voltage ..... 24-240VAC (50/60Hz) and 24VDC
- Power consumption ..... 3 watts max
- Input voltage tolerance ... -15% – +10%
- Input indicator ..... Green LED
- Time ranges ..... 0.1 second-10 hours
- Time settings by ..... Rotary switch
- Setting accuracy ..... 5%
- Repeatability ..... 0.2%
- Relay output form ..... SPDT
- Rated current ..... 8 Amps
- Switching capacity (max) .. 2500 VA/ AC, 240 W/ DC
- Output indicator ..... Red LED
- Mechanical life ..... 30 million operations
- Electrical life (resistive) ... 70,000 operations
- Control voltage ..... Same as input voltage
- Load on control terminal .. Yes
- Control switch ..... A1-S
- Pulse rate (min) ..... 25ms
- Reset time (max) ..... 120ms
- Operating temperature ... -20°C to +55°C
- Storage temperature ..... -30°C to +70°C
- Dielectric strength ..... 4 kV
- Operating position ..... any
- Mounting ..... DIN rail EN 60715
- Protection degree ..... IP 40 from front panel
- Wire size (max) ..... 14AWG
- Standards ..... EN 61812-1, EN 61010-1, UL, CE, RoHS

TIMING MODES

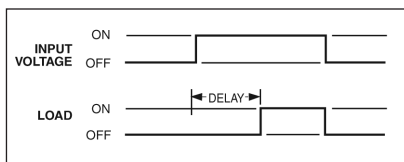

a DELAY ON MAKE

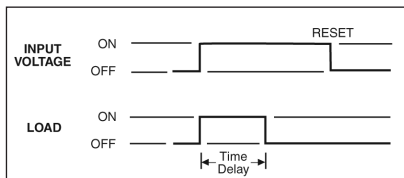

b INTERVAL ON

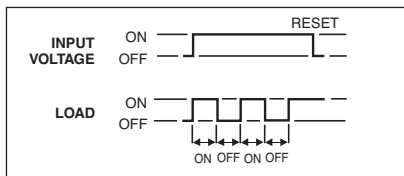

d REPEAT CYCLE

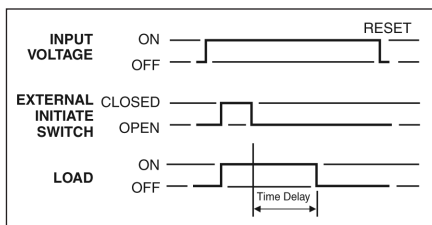

e DELAY ON BREAK

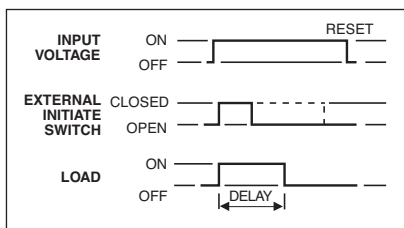

k RESETTABLE SINGLE SHOT

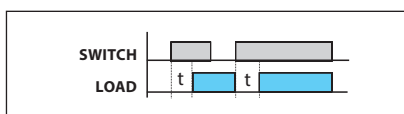

i DELAY ON MAKE with Control Switch

**FEATURES**

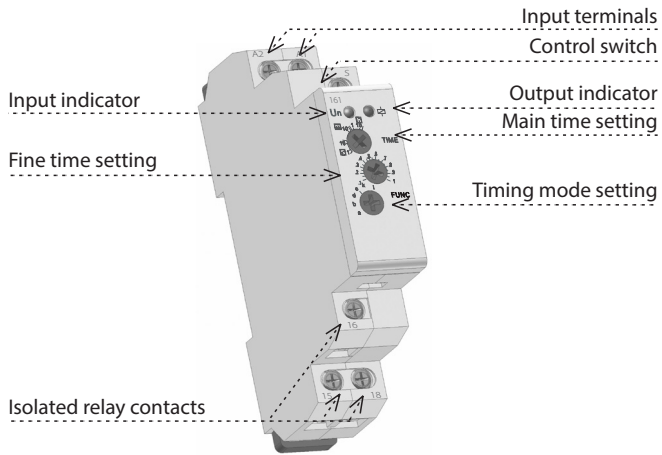

**WIRING DIAGRAM**

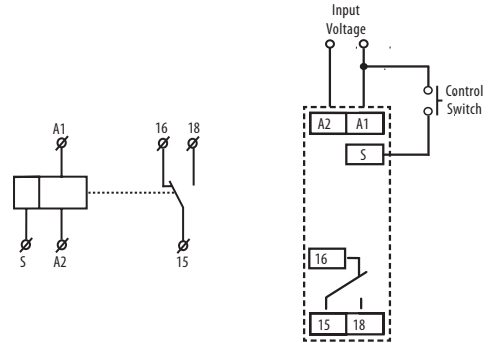

11/14/14