

QOPACK Module

Product Preview

NXH80T120L3Q0S3G/S3TG, NXH80T120L3Q0P3G

The NXH80T120L3Q0S3/P3G is a power module containing a T-type neutral point clamped (NPC) three level inverter stage. The integrated field stop trench IGBTs and fast recovery diodes provide lower conduction losses and switching losses, enabling designers to achieve high efficiency and superior reliability.

Features

- Low Switching Loss
- Low V_{CESAT}
- Compact 65.9 mm x 32.5 mm x 12 mm Package
- Options with Pre-applied Thermal Interface Material (TIM) and Without Pre-applied TIM
- Options with Solderable Pins and Press-fit Pins
- Thermistor

Typical Applications

- Solar Inverter
- Uninterruptable Power Supplies

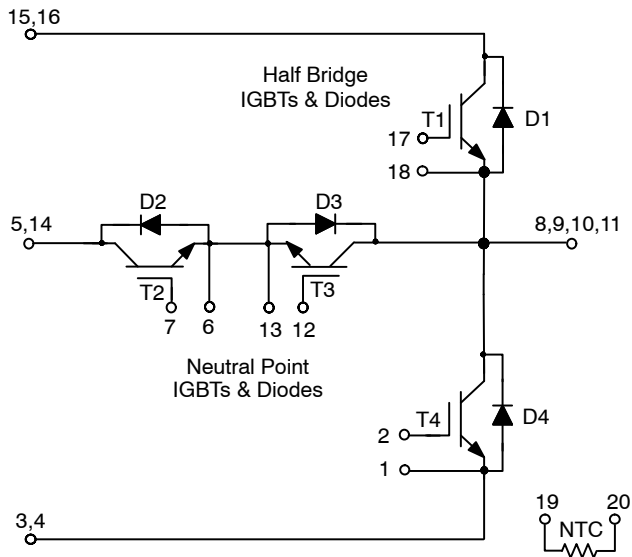

Figure 1. Schematic Diagram

This document contains information on a product under development. ON Semiconductor reserves the right to change or discontinue this product without notice.



ON Semiconductor®

www.onsemi.com

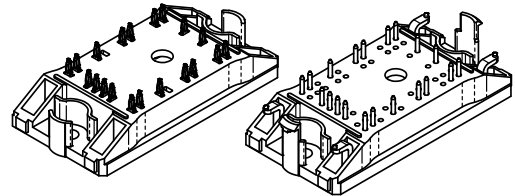

QOPACK
CASE 180AA
PRESS-FIT PINS

QOPACK
CASE 180AB
SOLDERABLE PINS

MARKING DIAGRAMS

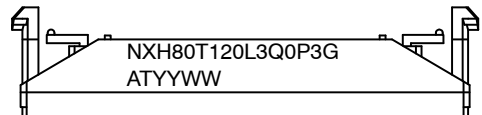
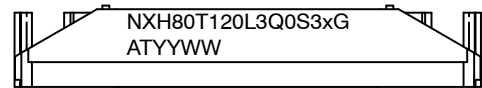

NXH80T120L3Q0S3G = Specific Device Code
S3xG = S3G or S3TG
G = Pb-free Package
A = Assembly Site Code
T = Test Site Code
YYWW = Year and Work Week Code

PIN ASSIGNMENTS

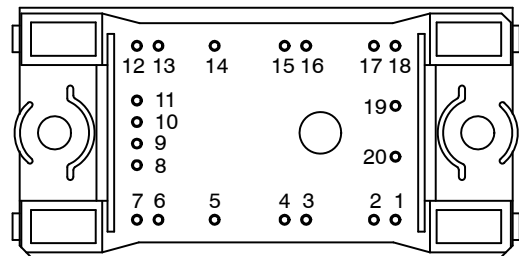

ORDERING INFORMATION

See detailed ordering and shipping information in the dimensions section on page 16 of this data sheet.

NXH80T120L3Q0S3G/S3TG, NXH80T120L3Q0P3G

Table 1. MAXIMUM RATINGS

Rating	Symbol	Value	Unit
HALF BRIDGE IGBT			
Collector–Emitter Voltage	V_{CES}	1200	V
Gate–Emitter Voltage	V_{GE}	± 20	V
Continuous Collector Current @ $T_c = 80^\circ\text{C}$ ($T_J = 175^\circ\text{C}$)	I_C	75	A
Pulsed Collector Current ($T_J = 175^\circ\text{C}$)	I_{Cpulse}	225	A
Maximum Power Dissipation ($T_J = 175^\circ\text{C}$)	P_{tot}	188	W
Minimum Operating Junction Temperature	T_{JMIN}	-40	$^\circ\text{C}$
Maximum Operating Junction Temperature	T_{JMAX}	175	$^\circ\text{C}$
NEUTRAL POINT IGBT			
Collector–Emitter Voltage	V_{CES}	650	V
Gate–Emitter Voltage	V_{GE}	± 20	V
Continuous Collector Current @ $T_c = 80^\circ\text{C}$ ($T_J = 175^\circ\text{C}$)	I_C	50	A
Pulsed Collector Current ($T_J = 175^\circ\text{C}$)	I_{Cpulse}	150	A
Maximum Power Dissipation ($T_J = 175^\circ\text{C}$)	P_{tot}	82	W
Minimum Operating Junction Temperature	T_{JMIN}	-40	$^\circ\text{C}$
Maximum Operating Junction Temperature	T_{JMAX}	150	$^\circ\text{C}$
HALF BRIDGE DIODE			
Peak Repetitive Reverse Voltage	V_{RRM}	1200	V
Continuous Forward Current @ $T_c = 80^\circ\text{C}$ ($T_J = 175^\circ\text{C}$)	I_F	37	A
Repetitive Peak Forward Current ($T_J = 175^\circ\text{C}$)	I_{FRM}	111	A
Maximum Power Dissipation ($T_J = 175^\circ\text{C}$)	P_{tot}	79	W
Minimum Operating Junction Temperature	T_{JMIN}	-40	$^\circ\text{C}$
Maximum Operating Junction Temperature	T_{JMAX}	175	$^\circ\text{C}$
NEUTRAL POINT DIODE			
Peak Repetitive Reverse Voltage	V_{RRM}	650	V
Continuous Forward Current @ $T_c = 80^\circ\text{C}$ ($T_J = 175^\circ\text{C}$)	I_F	37	A
Repetitive Peak Forward Current ($T_J = 175^\circ\text{C}$)	I_{FRM}	111	A
Maximum Power Dissipation ($T_J = 175^\circ\text{C}$)	P_{tot}	68	W
Minimum Operating Junction Temperature	T_{JMIN}	-40	$^\circ\text{C}$
Maximum Operating Junction Temperature	T_{JMAX}	150	$^\circ\text{C}$
THERMAL PROPERTIES			
Maximum Operating Junction Temperature under Switching Conditions	T_{VJOP}	150	$^\circ\text{C}$
Storage Temperature Range	T_{stg}	-40 to 125	$^\circ\text{C}$
Storage Temperature Range (TIM)	T_{stg}	-25 to 40	$^\circ\text{C}$
INSULATION PROPERTIES			
Isolation test voltage, $t = 1$ sec, 50 Hz	V_{is}	4000	V_{RMS}
Creepage distance		12.7	mm

Stresses exceeding those listed in the Maximum Ratings table may damage the device. If any of these limits are exceeded, device functionality should not be assumed, damage may occur and reliability may be affected.

1. Refer to ELECTRICAL CHARACTERISTICS, RECOMMENDED OPERATING RANGES and/or APPLICATION INFORMATION for Safe Operating parameters.

NXH80T120L3Q0S3G/S3TG, NXH80T120L3Q0P3G

Table 2. ELECTRICAL CHARACTERISTICS $T_J = 25^\circ\text{C}$ unless otherwise noted

Parameter	Test Conditions	Symbol	Min	Typ	Max	Unit
HALF BRIDGE IGBT CHARACTERISTICS						
Collector–Emitter Cutoff Current	$V_{GE} = 0\text{ V}, V_{CE} = 1200\text{ V}$	I_{CES}	–	–	300	μA
Collector–Emitter Saturation Voltage	$V_{GE} = 15\text{ V}, I_C = 80\text{ A}, T_J = 25^\circ\text{C}$	$V_{CE(sat)}$	–	1.7	2.4	V
	$V_{GE} = 15\text{ V}, I_C = 80\text{ A}, T_J = 150^\circ\text{C}$		–	1.8	–	
Gate–Emitter Threshold Voltage	$V_{GE} = V_{CE}, I_C = 2\text{ mA}$	$V_{GE(TH)}$	4.6	5.6	6.5	V
Gate Leakage Current	$V_{GE} = 20\text{ V}, V_{CE} = 0\text{ V}$	I_{GES}	–	–	300	nA
Turn-on Delay Time	$T_J = 25^\circ\text{C}$ $V_{CE} = 350\text{ V}, I_C = 60\text{ A}$ $V_{GE} = \pm 15\text{ V}, R_G = 4.7\ \Omega$	$t_{d(on)}$	–	51	–	ns
Rise Time		t_r	–	27	–	
Turn-off Delay Time		$t_{d(off)}$	–	200	–	
Fall Time		t_f	–	40	–	
Turn-on Switching Loss per Pulse		E_{on}	–	0.74	–	
Turn off Switching Loss per Pulse	E_{off}	–	1.41	–		
Turn-on Delay Time	$T_J = 125^\circ\text{C}$ $V_{CE} = 350\text{ V}, I_C = 60\text{ A}$ $V_{GE} = \pm 15\text{ V}, R_G = 4.7\ \Omega$	$t_{d(on)}$	–	45	–	ns
Rise Time		t_r	–	30	–	
Turn-off Delay Time		$t_{d(off)}$	–	230	–	
Fall Time		t_f	–	110	–	
Turn-on Switching Loss per Pulse		E_{on}	–	1.11	–	
Turn off Switching Loss per Pulse	E_{off}	–	2.17	–		
Input Capacitance	$V_{CE} = 20\text{ V}, V_{GE} = 0\text{ V}, f = 10\text{ kHz}$	C_{ies}	–	18150	–	pF
Output Capacitance		C_{oes}	–	345	–	
Reverse Transfer Capacitance		C_{res}	–	295	–	
Total Gate Charge	$V_{CE} = 600\text{ V}, I_C = 80\text{ A}, V_{GE} = \pm 15\text{ V}$	Q_g	–	817	–	nC
Thermal Resistance – chip-to–heatsink	Thermal grease, Thickness = 76 μm , $\lambda = 2.9\text{ W/mK}$	R_{thJH}	–	0.51	–	$^\circ\text{C/W}$

NEUTRAL POINT DIODE CHARACTERISTICS

Diode Forward Voltage	$I_F = 50\text{ A}, T_J = 25^\circ\text{C}$	V_F	–	1.38	2.1	V
	$I_F = 50\text{ A}, T_J = 150^\circ\text{C}$		–	1.27	–	
Reverse Recovery Time	$T_J = 25^\circ\text{C}$ $V_{CE} = 350\text{ V}, I_C = 60\text{ A}$ $V_{GE} = \pm 15\text{ V}, R_G = 4.7\ \Omega$	t_{rr}	–	32	–	ns
Reverse Recovery Charge		Q_{rr}	–	1.35	–	μC
Peak Reverse Recovery Current		I_{RRM}	–	64	–	A
Peak Rate of Fall of Recovery Current		di/dt	–	1100	–	$\text{A}/\mu\text{s}$
Reverse Recovery Energy		E_{rr}	–	280	–	μJ
Reverse Recovery Time	$T_J = 125^\circ\text{C}$ $V_{CE} = 350\text{ V}, I_C = 60\text{ A}$ $V_{GE} = \pm 15\text{ V}, R_G = 4.7\ \Omega$	t_{rr}	–	85	–	ns
Reverse Recovery Charge		Q_{rr}	–	3	–	μC
Peak Reverse Recovery Current		I_{RRM}	–	78	–	A
Peak Rate of Fall of Recovery Current		di/dt	–	6500	–	$\text{A}/\mu\text{s}$
Reverse Recovery Energy		E_{rr}	–	1390	–	μJ
Thermal Resistance – chip-to–heatsink	Thermal grease, Thickness = 76 μm , $\lambda = 2.9\text{ W/mK}$	R_{thJH}	–	1.39	–	$^\circ\text{C/W}$

NEUTRAL POINT IGBT CHARACTERISTICS

Collector–Emitter Cutoff Current	$V_{GE} = 0\text{ V}, V_{CE} = 600\text{ V}$	I_{CES}	–	–	200	μA
Collector–Emitter Saturation Voltage	$V_{GE} = 15\text{ V}, I_C = 50\text{ A}, T_J = 25^\circ\text{C}$	$V_{CE(sat)}$	–	1.0	1.4	V
	$V_{GE} = 15\text{ V}, I_C = 50\text{ A}, T_J = 150^\circ\text{C}$		–	0.93	–	
Gate–Emitter Threshold Voltage	$V_{GE} = V_{CE}, I_C = 250\ \mu\text{A}$	$V_{GE(TH)}$	3	3.6	5	V
Gate Leakage Current	$V_{GE} = 20\text{ V}, V_{CE} = 0\text{ V}$	I_{GES}	–	–	500	nA

NXH80T120L3Q0S3G/S3TG, NXH80T120L3Q0P3G

Table 2. ELECTRICAL CHARACTERISTICS $T_J = 25^\circ\text{C}$ unless otherwise noted

Parameter	Test Conditions	Symbol	Min	Typ	Max	Unit
NEUTRAL POINT IGBT CHARACTERISTICS						
Turn-on Delay Time	$T_J = 25^\circ\text{C}$ $V_{CE} = 350\text{ V}, I_C = 60\text{ A}$ $V_{GE} = \pm 15\text{ V}, R_G = 20\ \Omega$	$t_{d(on)}$	-	65	-	ns
Rise Time		t_r	-	20	-	
Turn-off Delay Time		$t_{d(off)}$	-	660	-	
Fall Time		t_f	-	20	-	
Turn-on Switching Loss per Pulse		E_{on}	-	1.37	-	mJ
Turn off Switching Loss per Pulse		E_{off}	-	0.9	-	
Turn-on Delay Time	$T_J = 125^\circ\text{C}$ $V_{CE} = 350\text{ V}, I_C = 60\text{ A}$ $V_{GE} = \pm 15\text{ V}, R_G = 20\ \Omega$	$t_{d(on)}$	-	70	-	ns
Rise Time		t_r	-	28	-	
Turn-off Delay Time		$t_{d(off)}$	-	720	-	
Fall Time		t_f	-	30	-	
Turn-on Switching Loss per Pulse		E_{on}	-	2.45	-	mJ
Turn off Switching Loss per Pulse		E_{off}	-	1.0	-	
Input Capacitance	$V_{CE} = 20\text{ V}, V_{GE} = 0\text{ V}, f = 10\text{ kHz}$	C_{ies}	-	16881	-	pF
Output Capacitance		C_{oes}	-	107	-	
Reverse Transfer Capacitance		C_{res}	-	94	-	
Total Gate Charge	$V_{CE} = 480\text{ V}, I_C = 50\text{ A}, V_{GE} = \pm 15\text{ V}$	Q_g	-	830	-	nC
Thermal Resistance – chip-to-heatsink	Thermal grease, Thickness = 76 μm , $\lambda = 2.9\text{ W/mK}$	R_{thJH}	-	1.16	-	$^\circ\text{C/W}$

HALF BRIDGE DIODE CHARACTERISTICS

Diode Forward Voltage	$I_F = 40\text{ A}, T_J = 25^\circ\text{C}$	V_F	-	2.43	3.10	V
	$I_F = 40\text{ A}, T_J = 150^\circ\text{C}$		-	1.63	-	
Reverse recovery time	$T_J = 25^\circ\text{C}$ $V_{CE} = 350\text{ V}, I_C = 60\text{ A}$ $V_{GE} = \pm 15\text{ V}, R_G = 62\ \Omega$	t_{rr}	-	45	-	ns
Reverse recovery charge		Q_{rr}	-	2	-	μC
Peak reverse recovery current		I_{RRM}	-	140	-	A
Peak rate of fall of recovery current		di/dt	-	860	-	$\text{A}/\mu\text{s}$
Reverse recovery energy		E_{rr}	-	310	-	μJ
Reverse recovery time		$T_J = 125^\circ\text{C}$ $V_{CE} = 350\text{ V}, I_C = 60\text{ A}$ $V_{GE} = \pm 15\text{ V}, R_G = 62\ \Omega$	t_{rr}	-	75	-
Reverse recovery charge	Q_{rr}		-	5.5	-	μC
Peak reverse recovery current	I_{RRM}		-	125	-	A
Peak rate of fall of recovery current	di/dt		-	740	-	$\text{A}/\mu\text{s}$
Reverse recovery energy	E_{rr}		-	640	-	μJ
Thermal Resistance – chip-to-heatsink	Thermal grease, Thickness = 76 μm , $\lambda = 2.9\text{ W/mK}$		R_{thJH}	-	1.2	-

THERMISTOR CHARACTERISTICS

Nominal resistance		R	-	22	-	k Ω
Nominal resistance	$T = 100^\circ\text{C}$	R	-	1468	-	Ω
Deviation of R25		$\Delta R/R$	-5	-	5	%
Power dissipation		P_D	-	200	-	mW
Power dissipation constant			-	2	-	mW/K
B-value	B(25/50), tolerance $\pm 3\%$		-	-	3950	K
B-value	B(25/100), tolerance $\pm 3\%$		-	-	3998	K
NTC reference					B	

Product parametric performance is indicated in the Electrical Characteristics for the listed test conditions, unless otherwise noted. Product performance may not be indicated by the Electrical Characteristics if operated under different conditions.

NXH80T120L3Q0S3G/S3TG, NXH80T120L3Q0P3G

TYPICAL CHARACTERISTICS – HALF BRIDGE IGBT AND DIODE

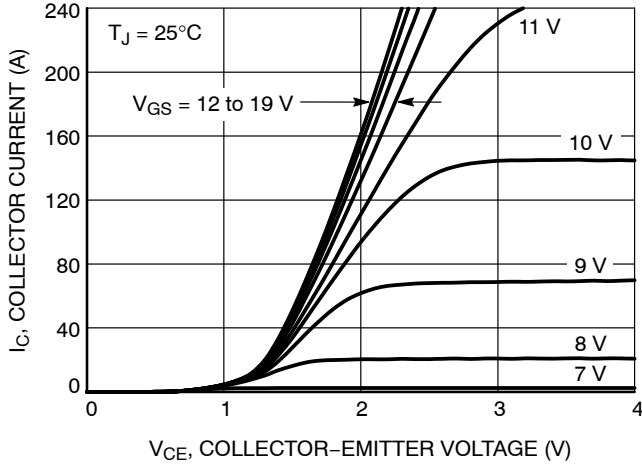

Figure 2. Typical Output Characteristics

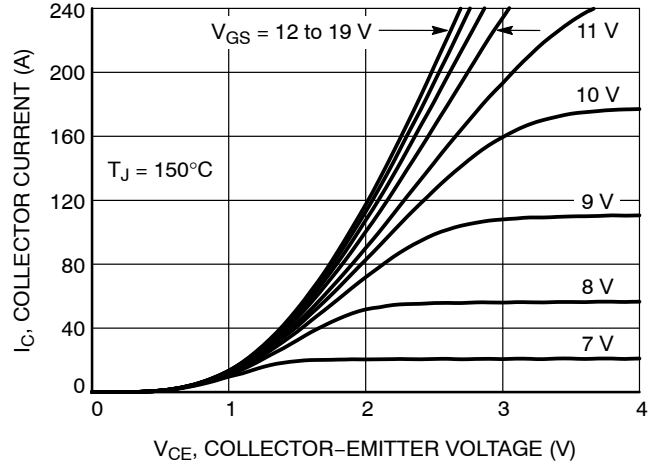

Figure 3. Typical Output Characteristics

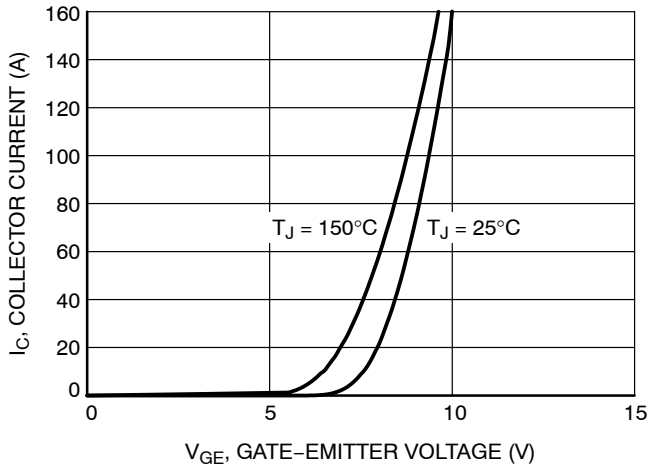

Figure 4. Typical Transfer Characteristics

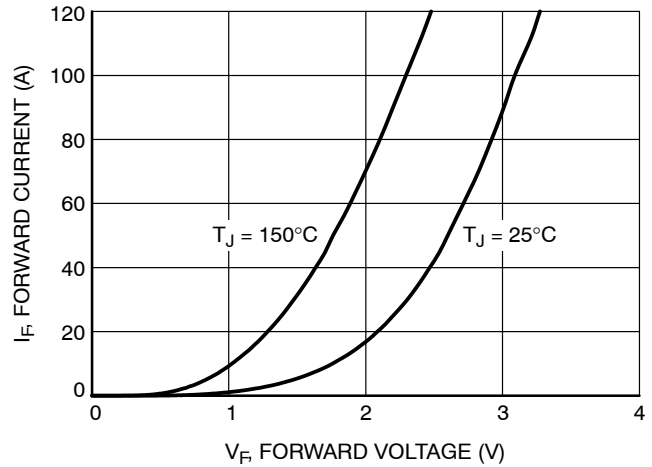

Figure 5. Typical Diode Forward Characteristics

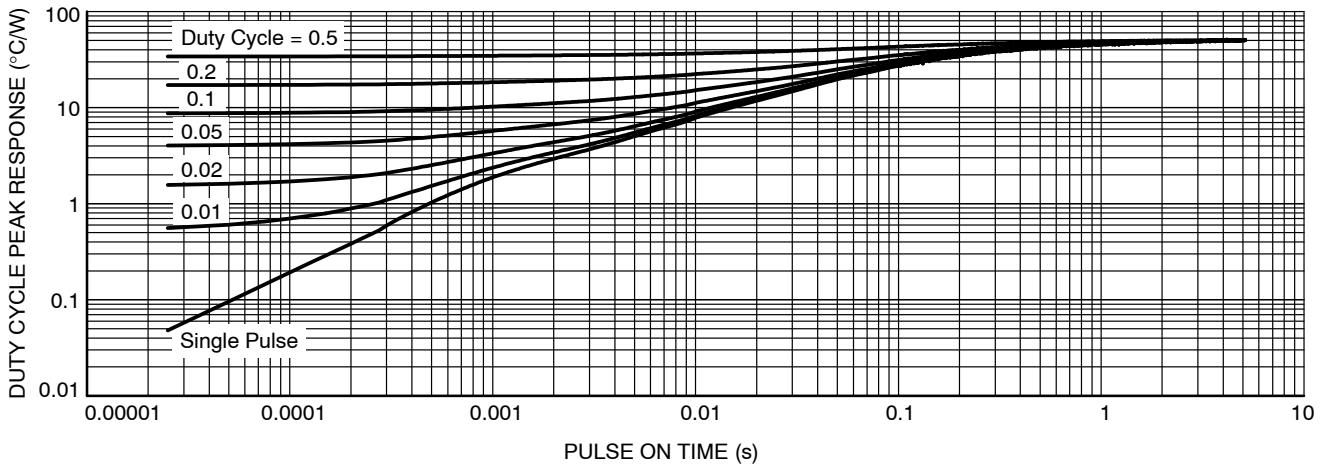

Figure 6. Transient Thermal Impedance (Half Bridge IGBT)

NXH80T120L3Q0S3G/S3TG, NXH80T120L3Q0P3G

TYPICAL CHARACTERISTICS – HALF BRIDGE IGBT AND DIODE

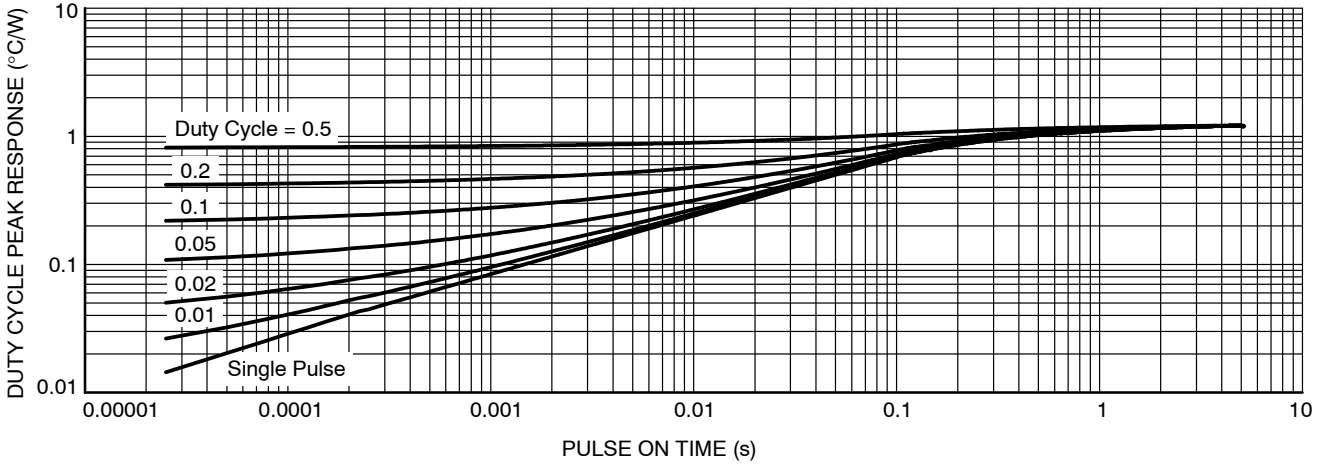

Figure 7. Transient Thermal Impedance (Half Bridge Diode)

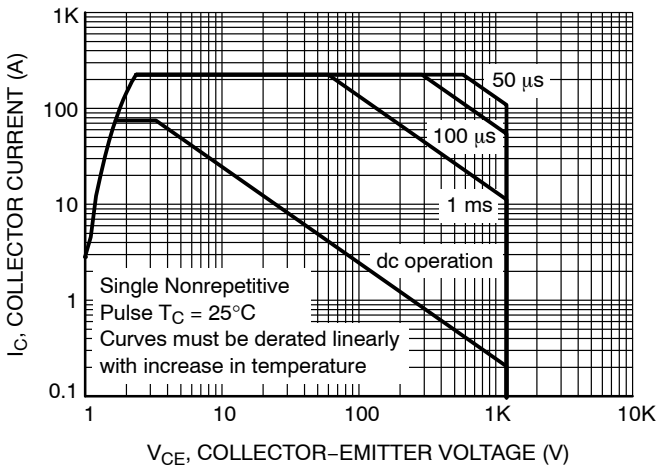

Figure 8. FB Safe Operating Area

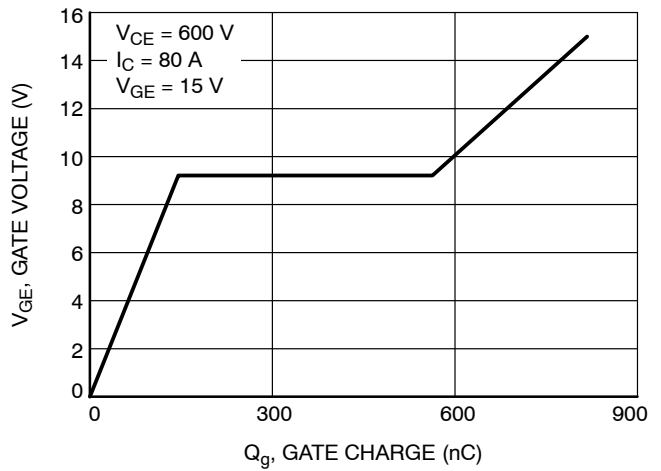

Figure 9. Gate Voltage vs. Gate Charge

TYPICAL CHARACTERISTICS – NEUTRAL POINT IGBT AND DIODE

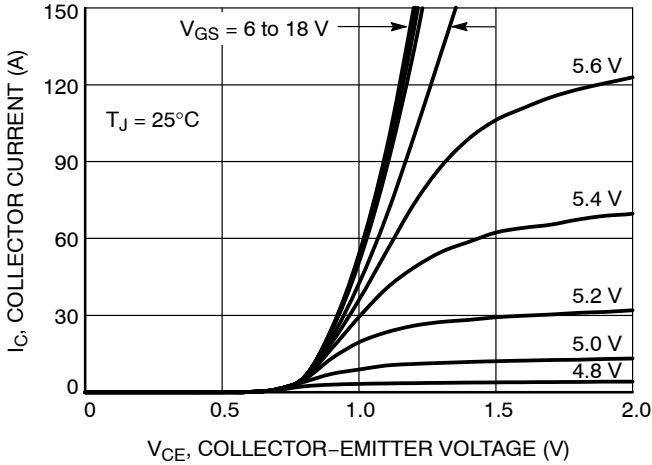

Figure 10. Typical Output Characteristics

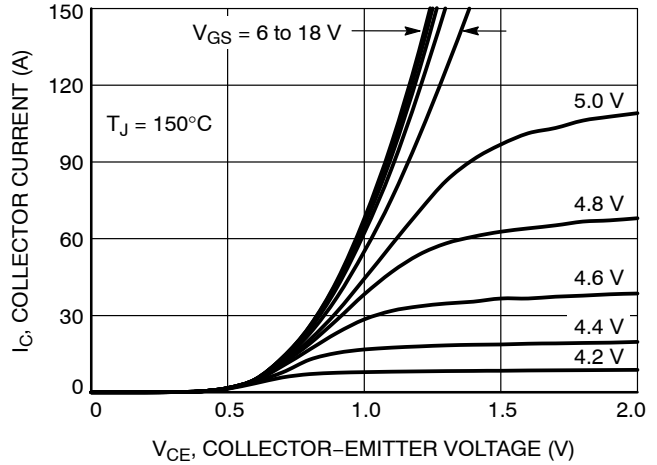

Figure 11. Typical Output Characteristics

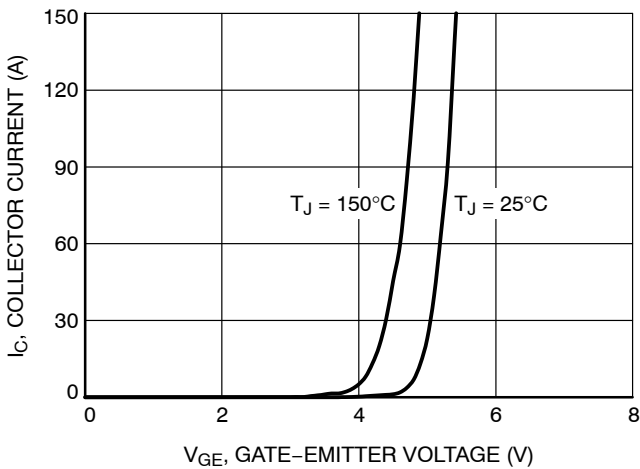

Figure 12. Typical Transfer Characteristics

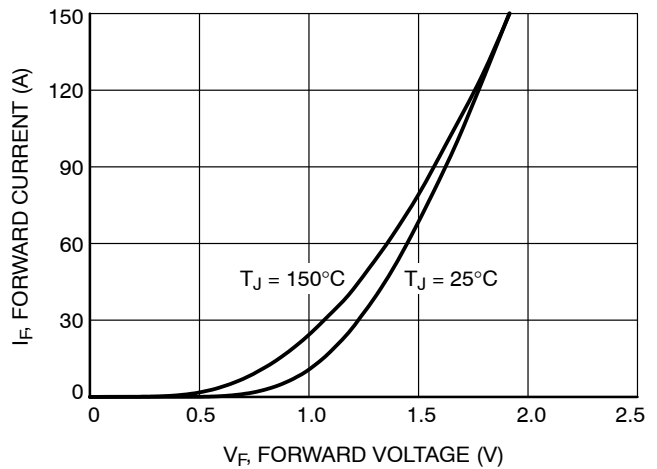

Figure 13. Typical Diode Forward Characteristics

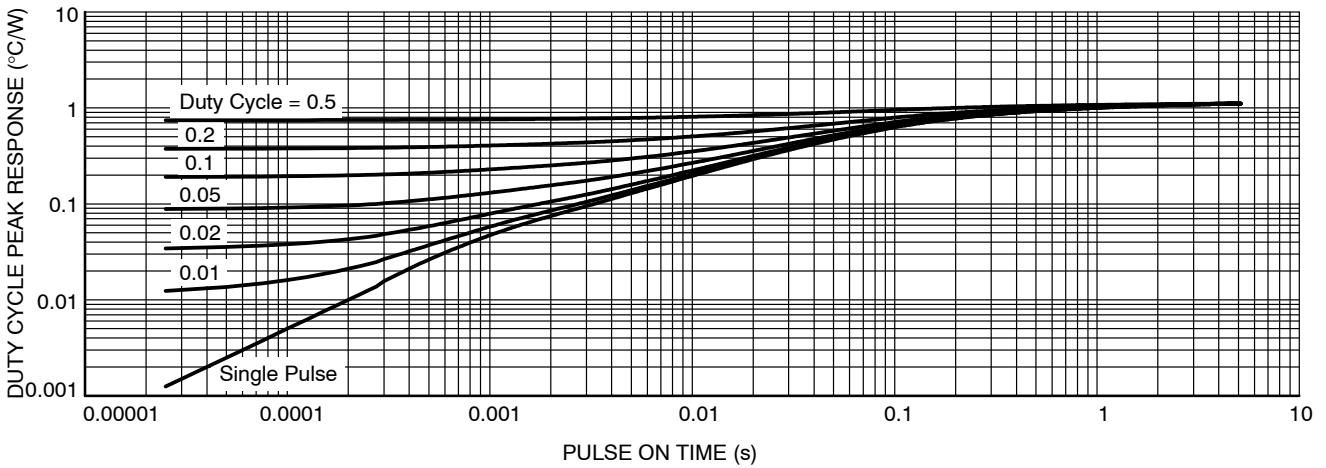

Figure 14. Transient Thermal Impedance (Neutral Point IGBT)

NXH80T120L3Q0S3G/S3TG, NXH80T120L3Q0P3G

TYPICAL CHARACTERISTICS – NEUTRAL POINT IGBT AND DIODE

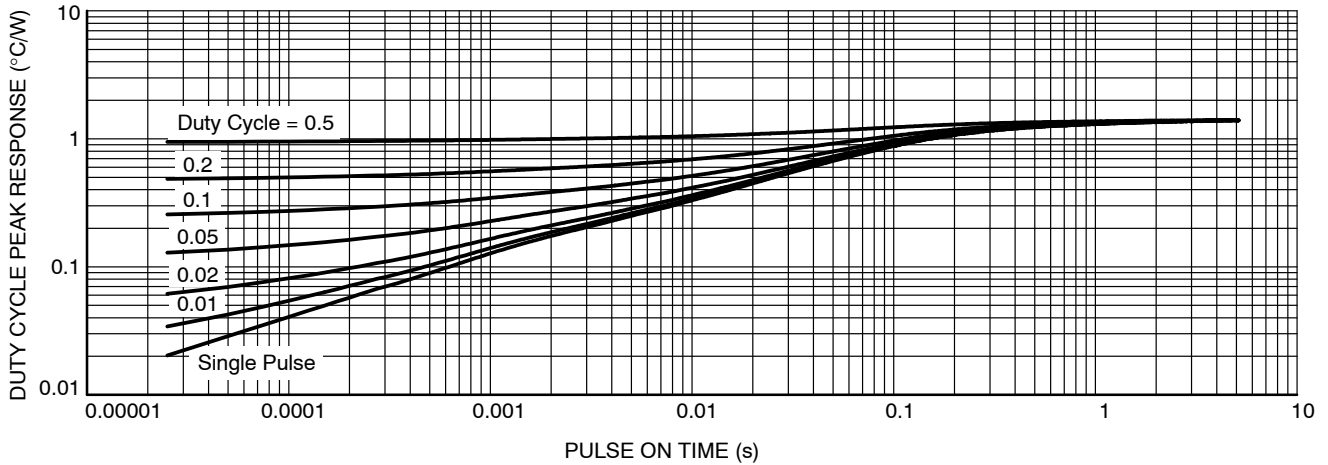

Figure 15. Transient Thermal Impedance (Neutral Point Diode)

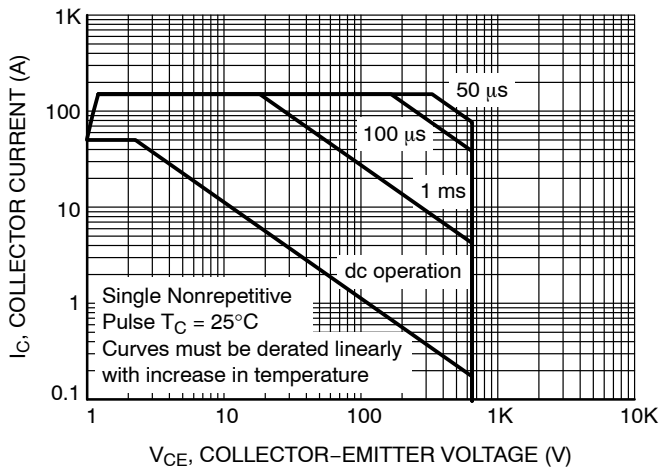

Figure 16. FB Safe Operating Area

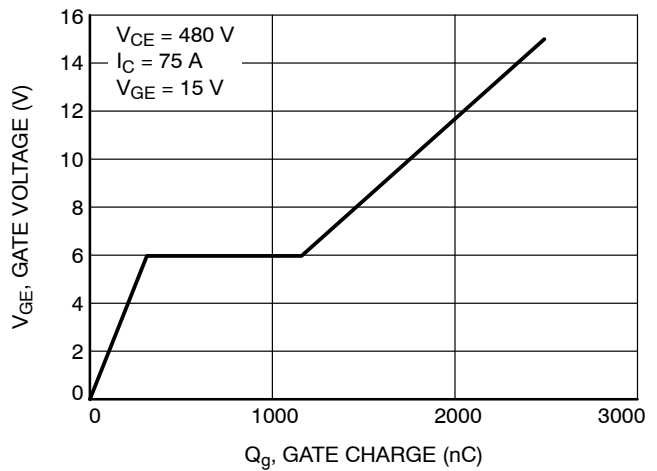

Figure 17. Gate Voltage vs. Gate Charge

NXH80T120L3Q0S3G/S3TG, NXH80T120L3Q0P3G

TYPICAL CHARACTERISTICS – HALF BRIDGE IGBT COMMUTATES NEUTRAL POINT DIODE

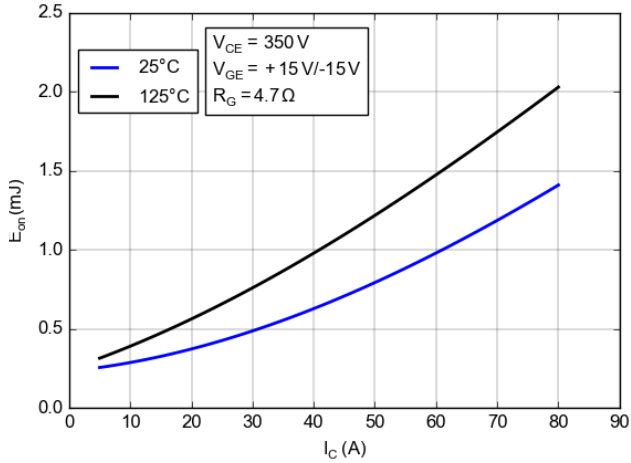

Figure 18. Typical Turn On Loss vs. I_C

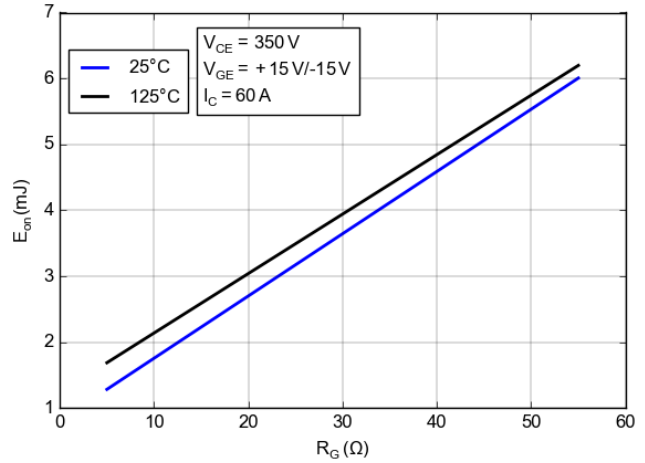

Figure 19. Typical Turn On Loss vs. R_G

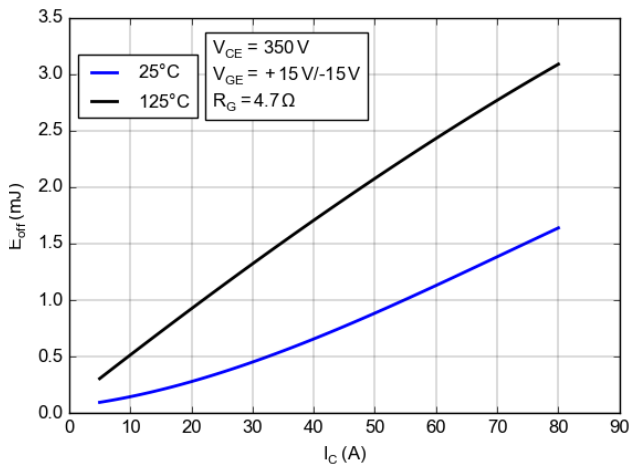

Figure 20. Typical Turn Off Loss vs. I_C

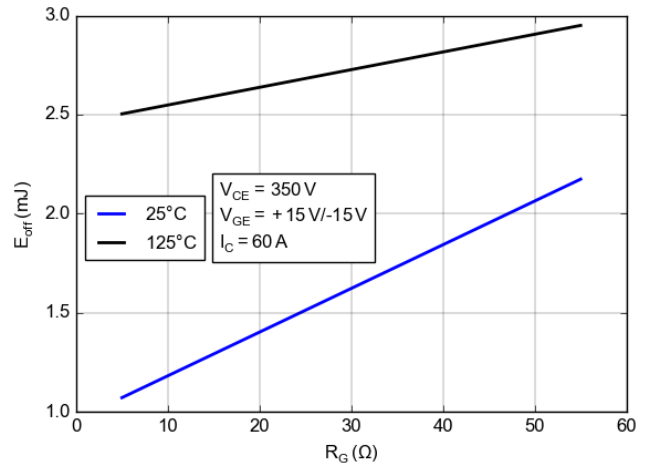

Figure 21. Typical Turn Off Loss vs. R_G

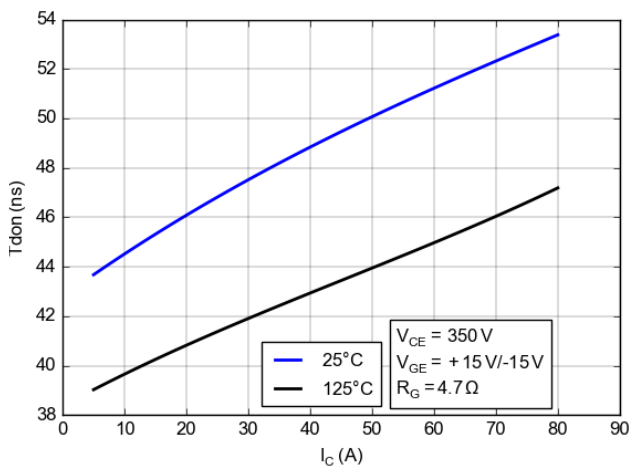

Figure 22. Typical Switching Times T_{don} vs. I_C

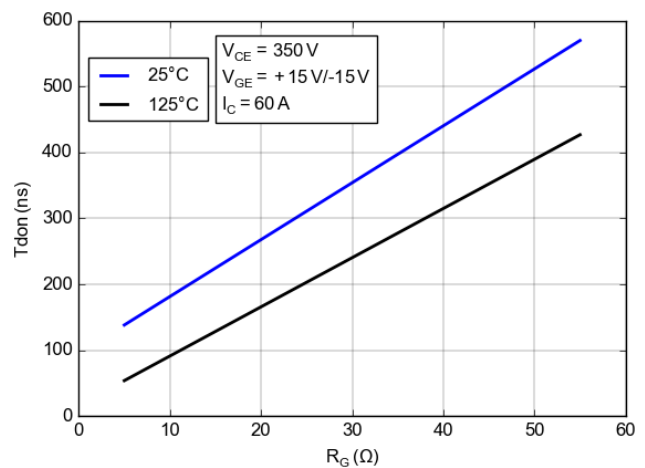

Figure 23. Typical Switching Times T_{don} vs. R_G

TYPICAL CHARACTERISTICS – HALF BRIDGE IGBT COMMUTATES NEUTRAL POINT DIODE

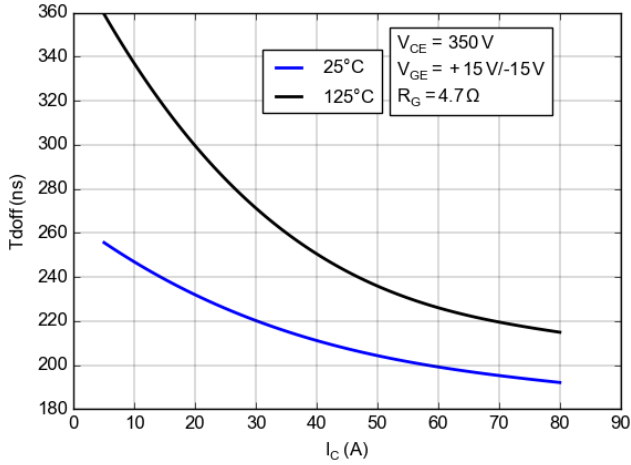

Figure 24. Typical Switching Times Tdoff vs. I_C

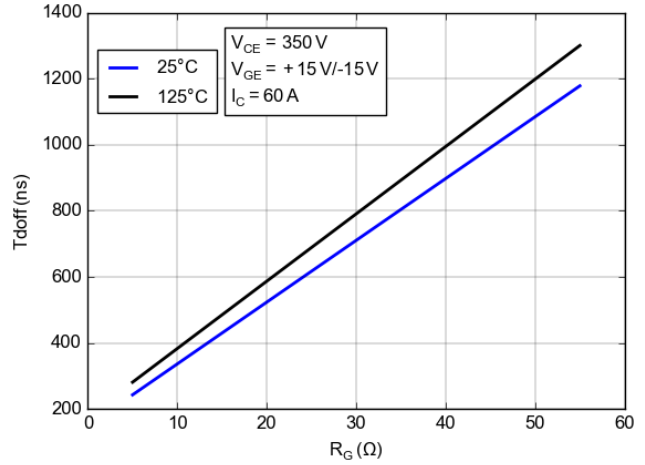

Figure 25. Typical Switching Times Tdoff vs. R_G

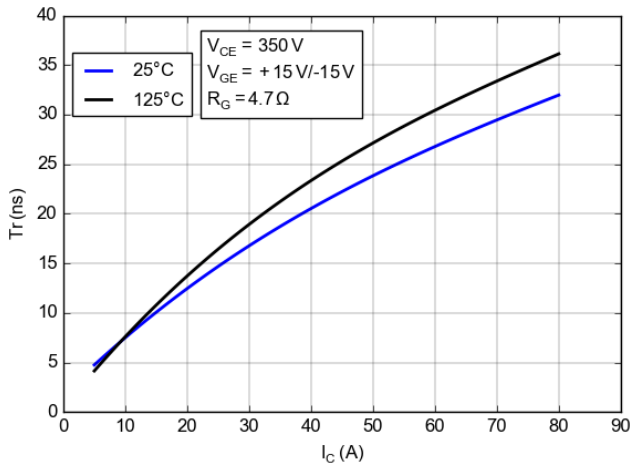

Figure 26. Typical Switching Times Tron vs. I_C

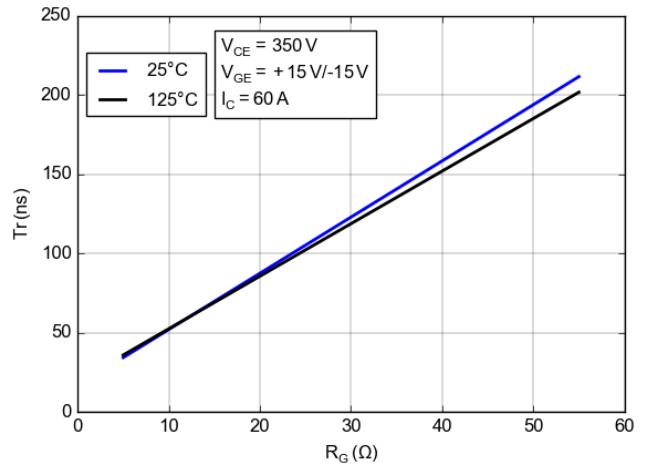

Figure 27. Typical Switching Times Tron vs. R_G

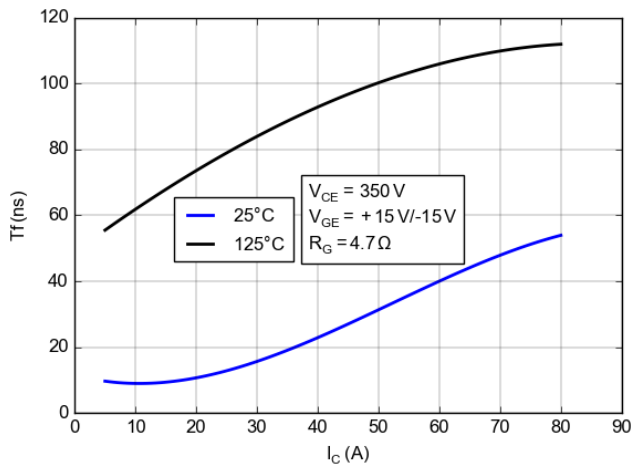

Figure 28. Typical Switching Times Tf vs. I_C

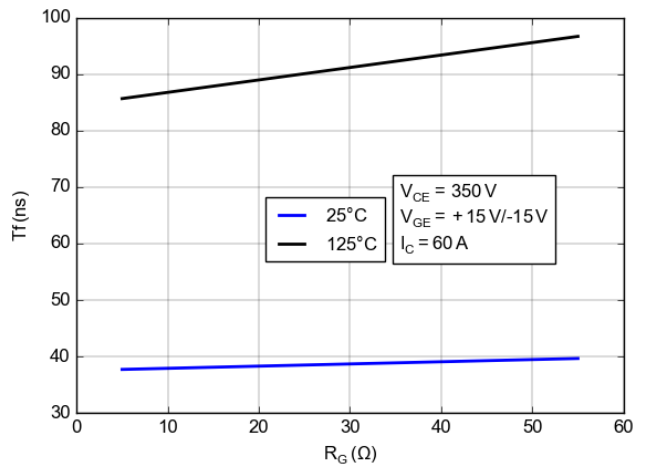

Figure 29. Typical Switching Times Tf vs. R_G

TYPICAL CHARACTERISTICS – HALF BRIDGE IGBT COMMUTATES NEUTRAL POINT DIODE

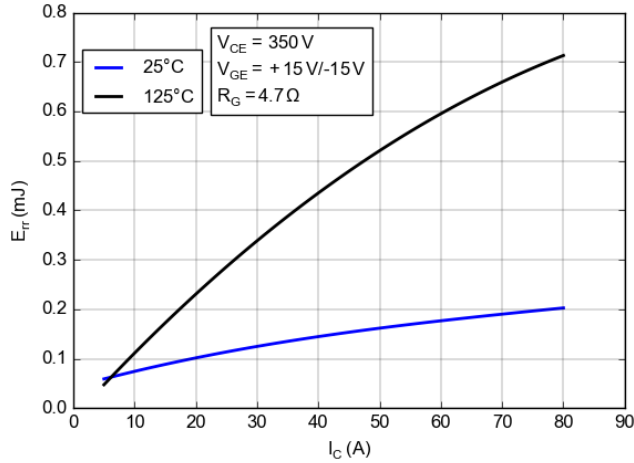

Figure 30. Typical Reverse Recovery Energy vs. I_C

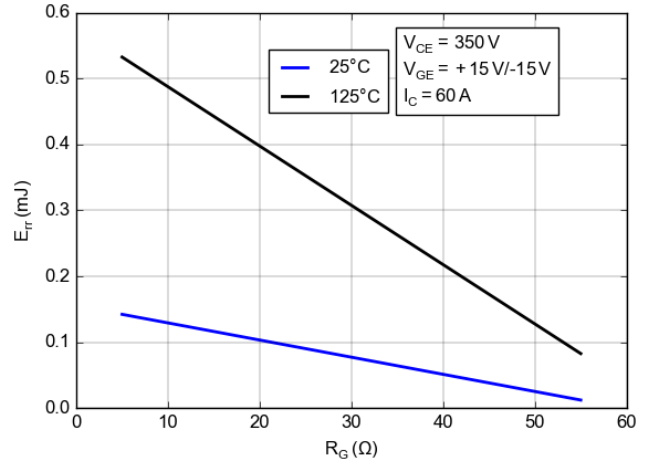

Figure 31. Typical Reverse Recovery Energy vs. R_G

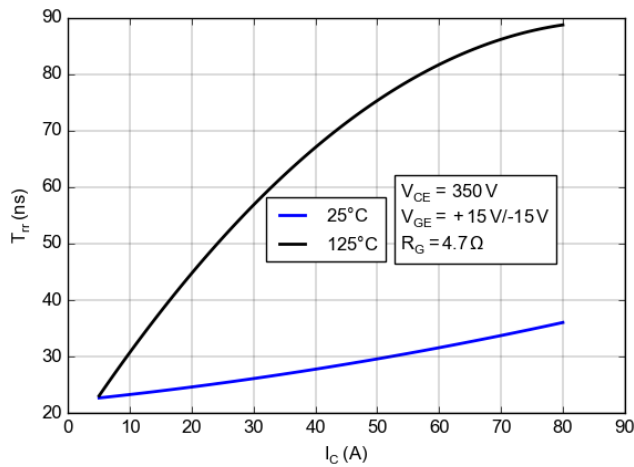

Figure 32. Typical Reverse Recovery Time vs. I_C

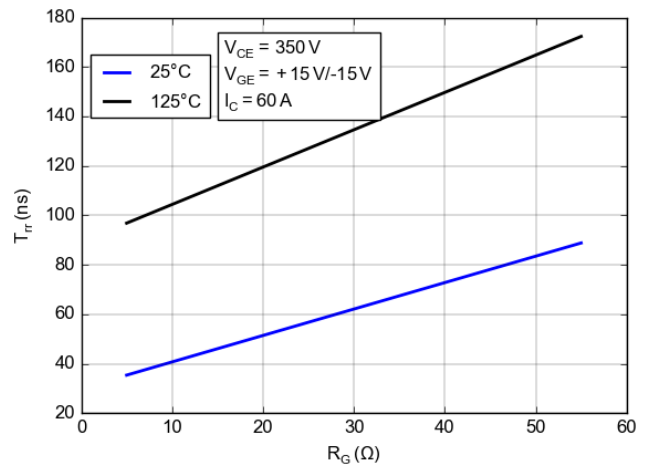

Figure 33. Typical Reverse Recovery Time vs. R_G

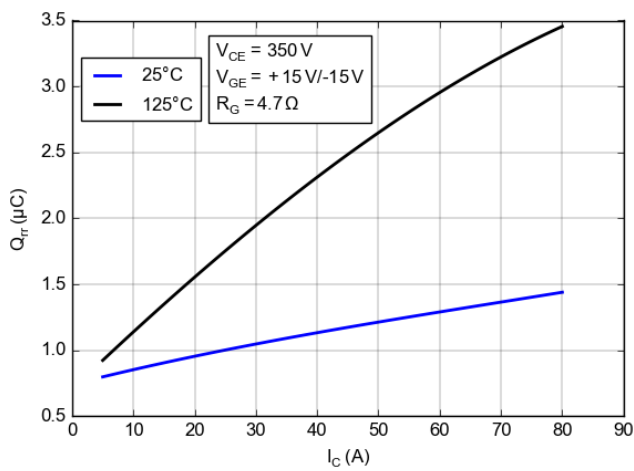

Figure 34. Typical Reverse Recovery Charge vs. I_C

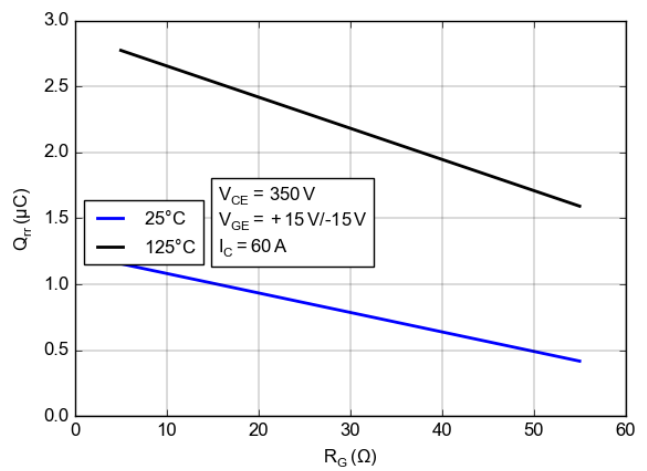

Figure 35. Typical Reverse Recovery Charge vs. R_G

TYPICAL CHARACTERISTICS – HALF BRIDGE IGBT COMMUTATES NEUTRAL POINT DIODE

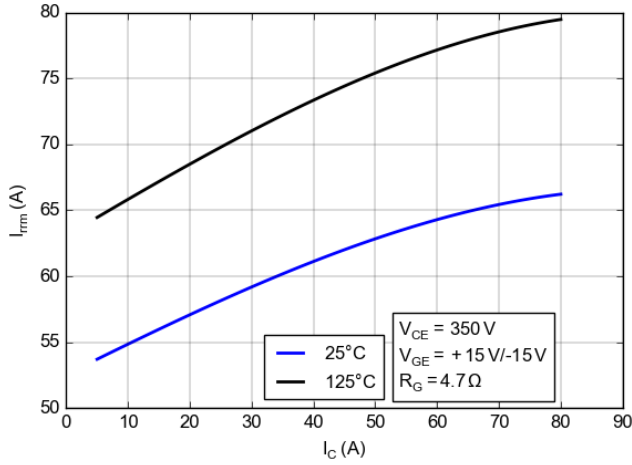

Figure 36. Typical Reverse Recovery Current vs. I_C

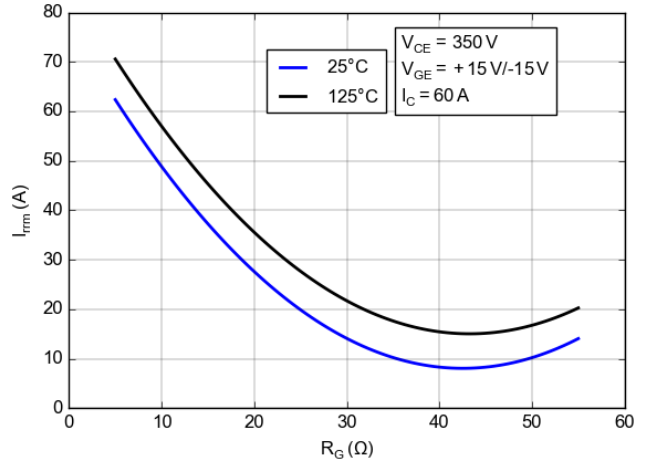

Figure 37. Typical Reverse Recovery Current vs. R_G

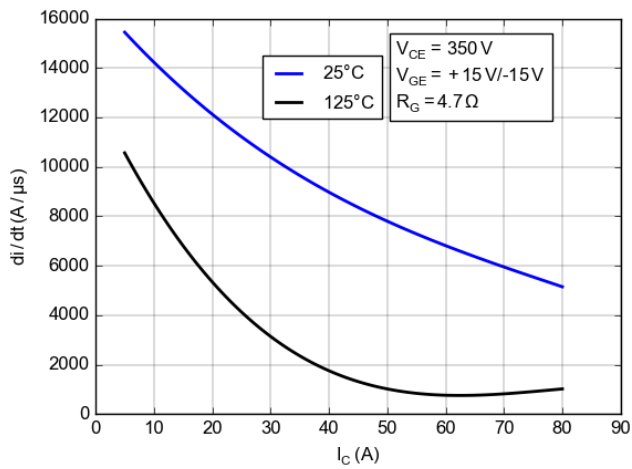

Figure 38. Typical di/dt vs. I_C

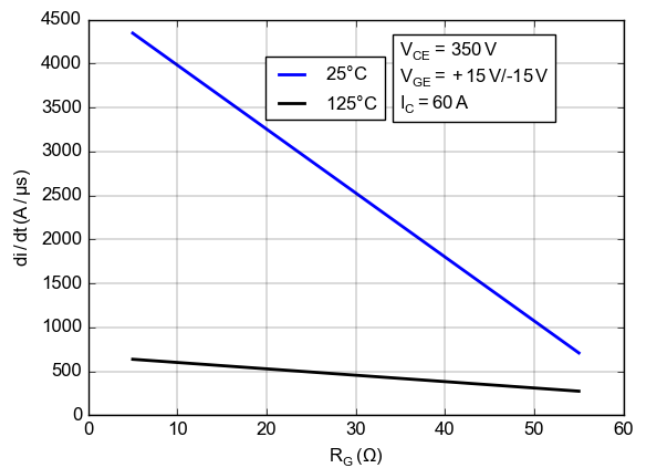

Figure 39. Typical di/dt vs. R_G

TYPICAL CHARACTERISTICS – NEUTRAL POINT IGBT COMMUTATES HALF BRIDGE DIODE

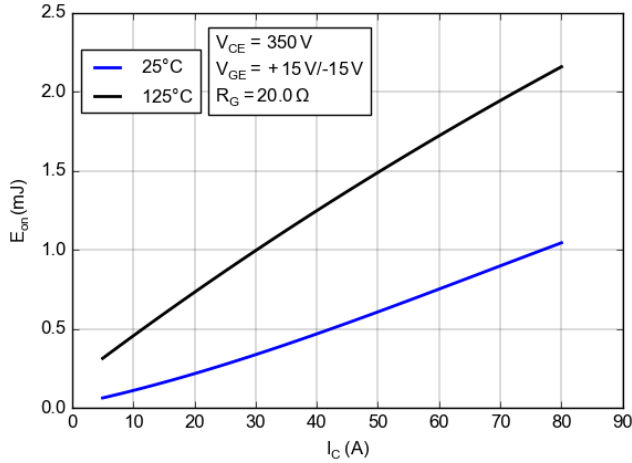

Figure 40. Typical Turn On Loss vs. I_C

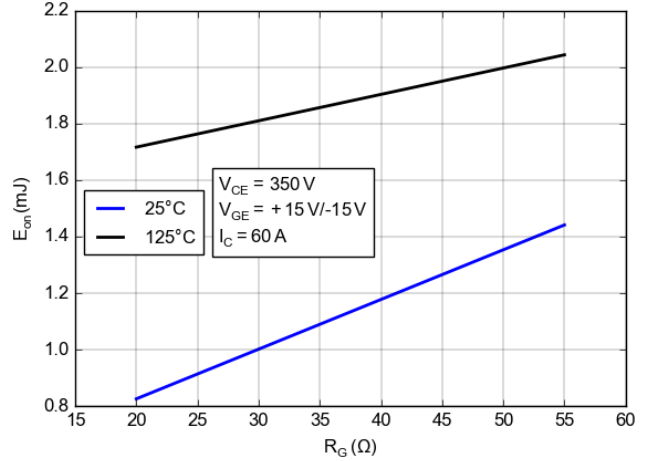

Figure 41. Typical Turn On Loss vs. R_G

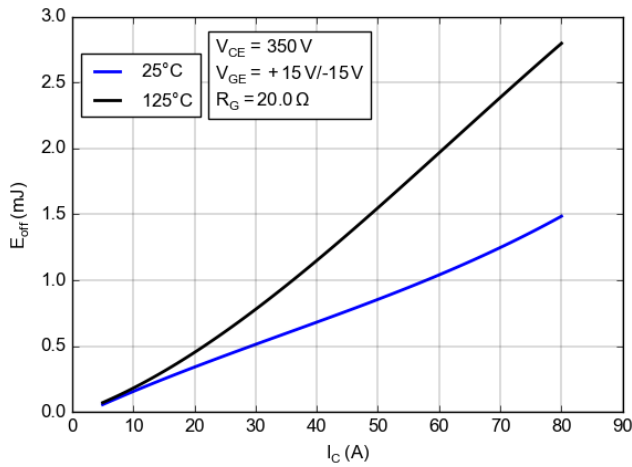

Figure 42. Typical Turn Off Loss vs. I_C

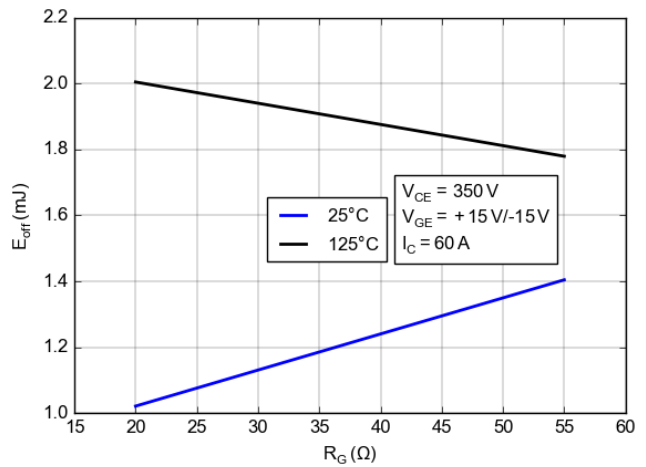

Figure 43. Typical Turn Off Loss vs. R_G

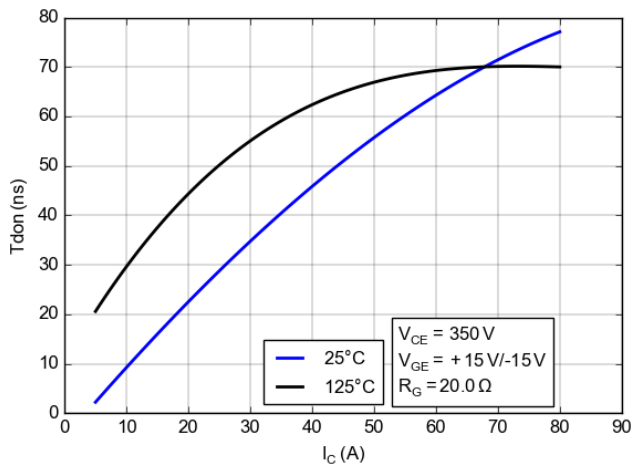

Figure 44. Typical Switching Times T_{don} vs. I_C

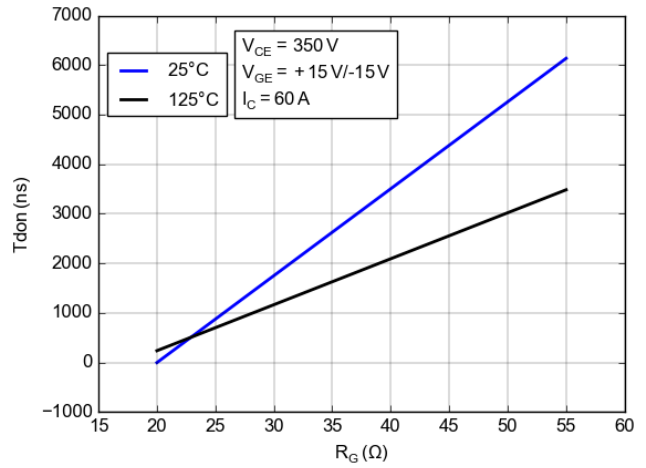

Figure 45. Typical Switching Times T_{don} vs. R_G

TYPICAL CHARACTERISTICS – NEUTRAL POINT IGBT COMMUTATES HALF BRIDGE DIODE

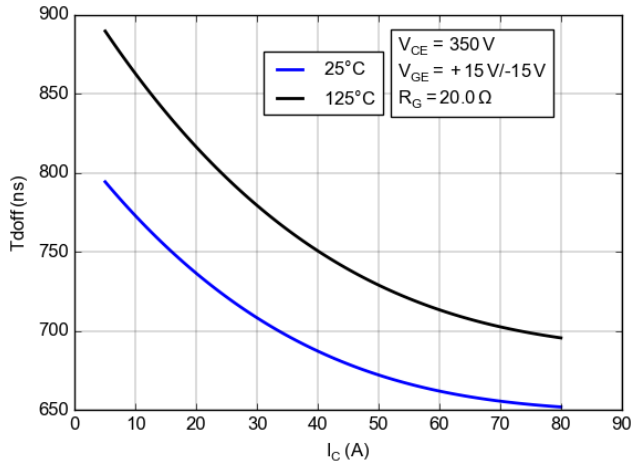

Figure 46. Typical Switching Times Tdoff vs. I_C

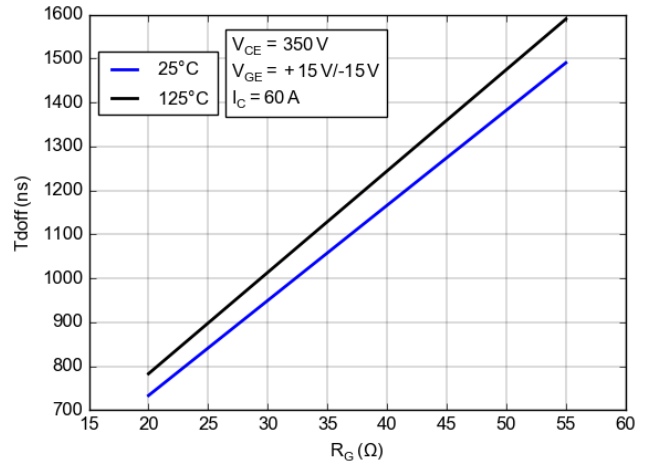

Figure 47. Typical Switching Times Tdoff vs. R_G

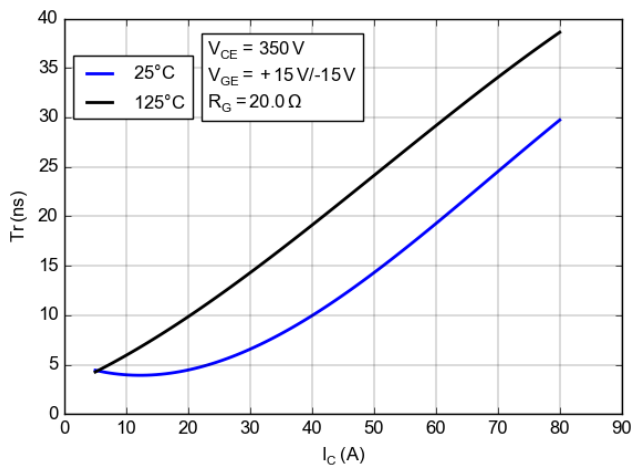

Figure 48. Typical Switching Times Tron vs. I_C

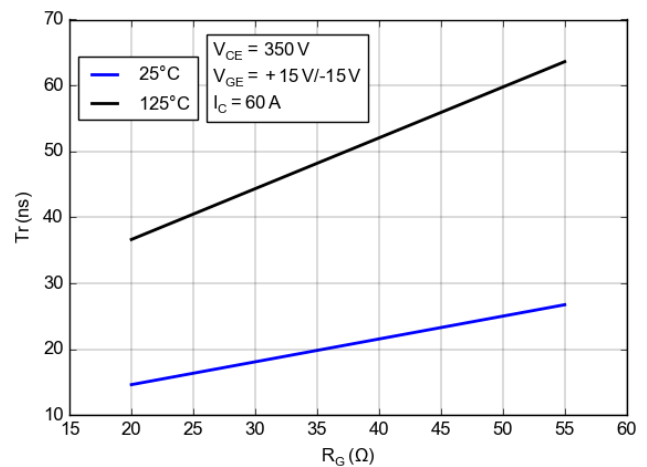

Figure 49. Typical Switching Times Tron vs. R_G

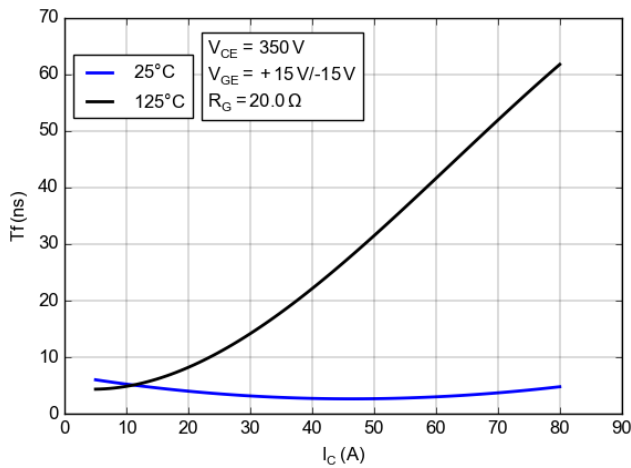

Figure 50. Typical Switching Times Tf vs. I_C

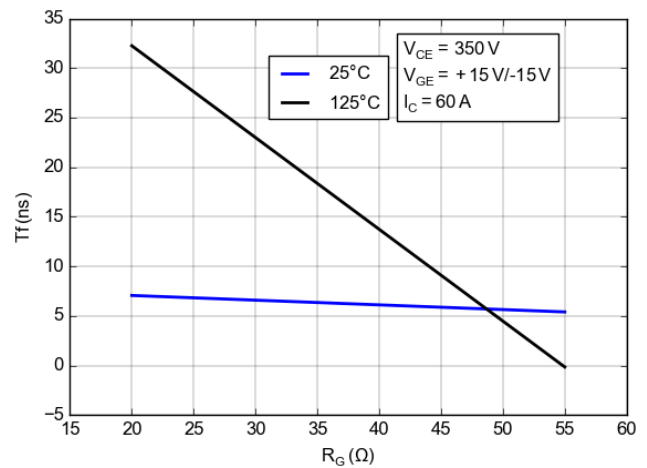

Figure 51. Typical Switching Times Tf vs. R_G

TYPICAL CHARACTERISTICS – NEUTRAL POINT IGBT COMMUTATES HALF BRIDGE DIODE

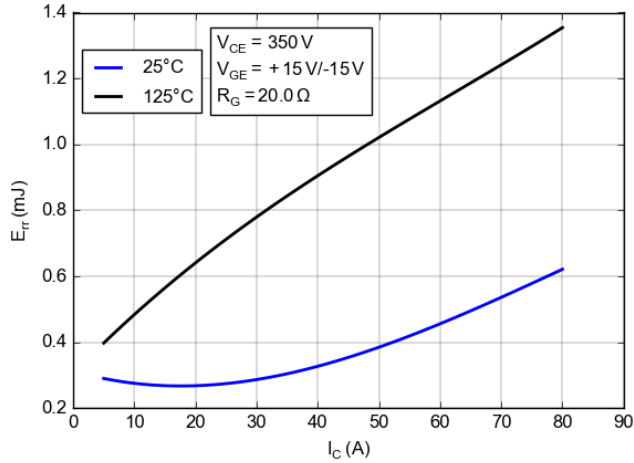

Figure 52. Typical Reverse Recovery Energy vs. I_C

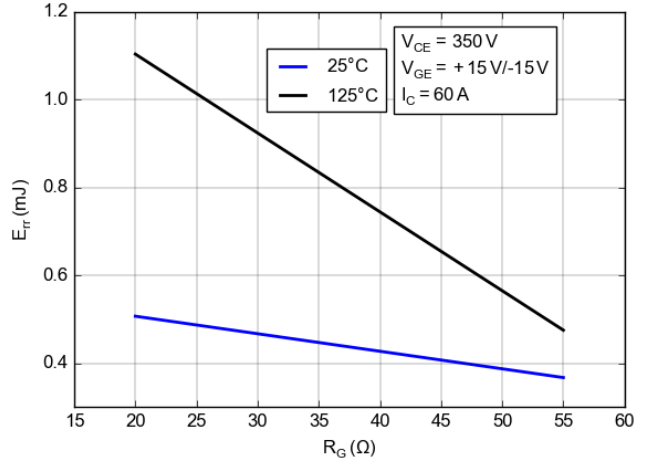

Figure 53. Typical Reverse Recovery Energy vs. R_G

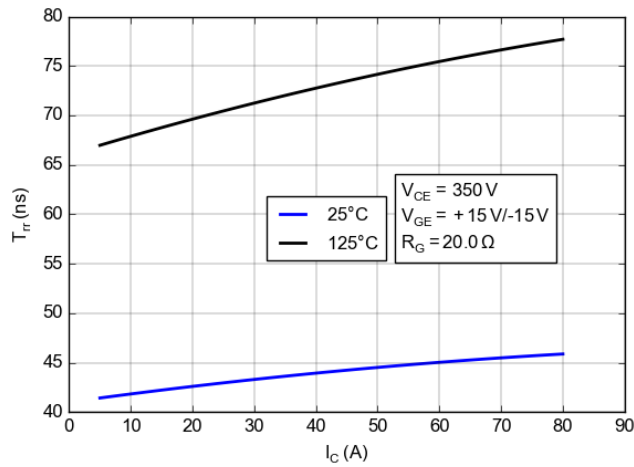

Figure 54. Typical Reverse Recovery Time vs. I_C

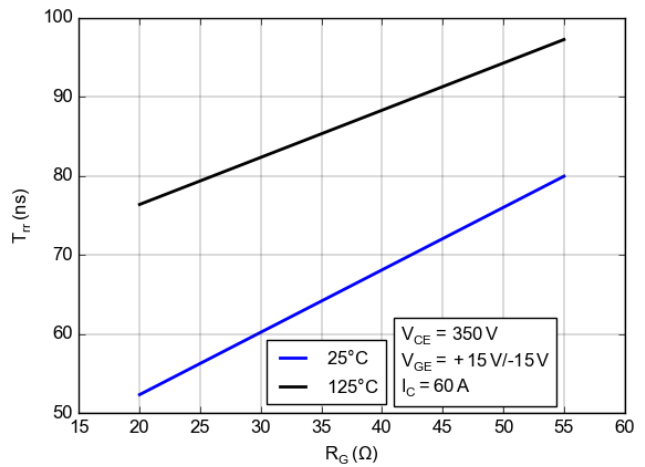

Figure 55. Typical Reverse Recovery Time vs. R_G

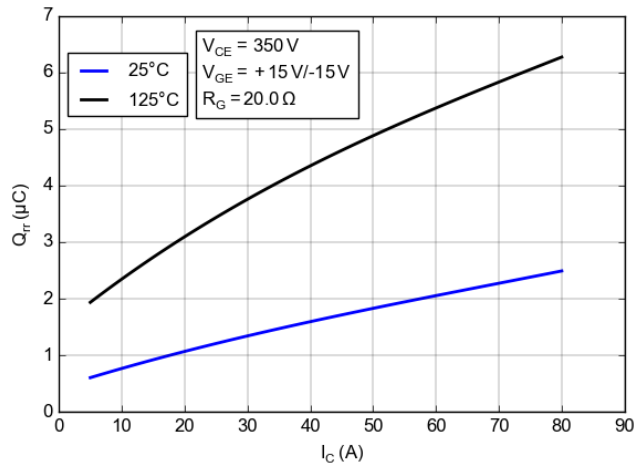

Figure 56. Typical Reverse Recovery Charge vs. I_C

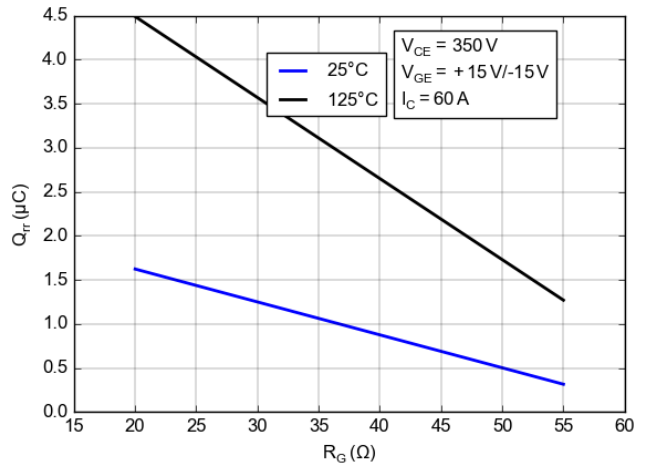

Figure 57. Typical Reverse Recovery Charge vs. R_G

NXH80T120L3Q0S3G/S3TG, NXH80T120L3Q0P3G

TYPICAL CHARACTERISTICS – NEUTRAL POINT IGBT COMMUTATES HALF BRIDGE DIODE

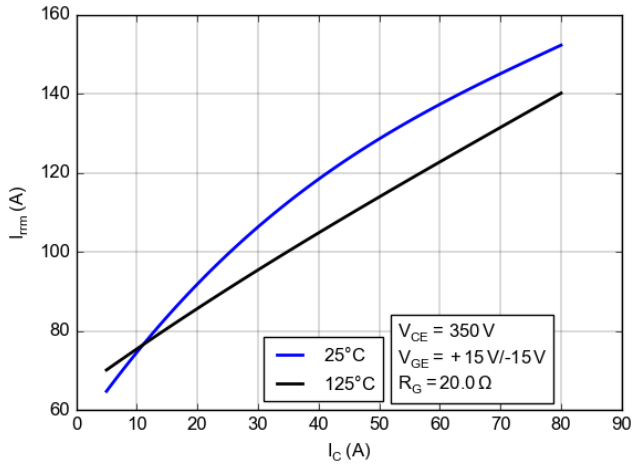

Figure 58. Typical Reverse Recovery Current vs. I_C

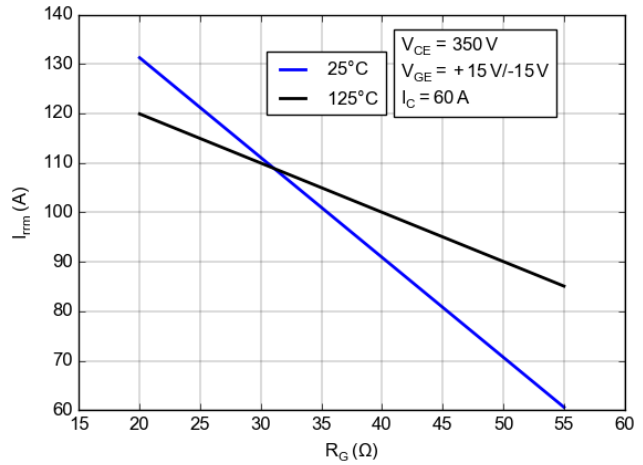

Figure 59. Typical Reverse Recovery Current vs. R_G

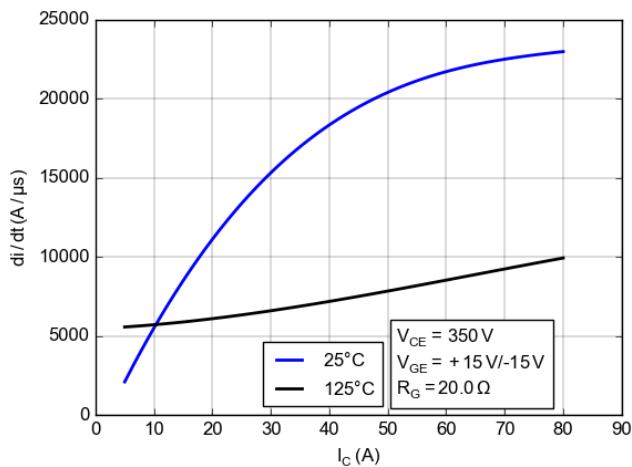

Figure 60. Typical di/dt vs I_C

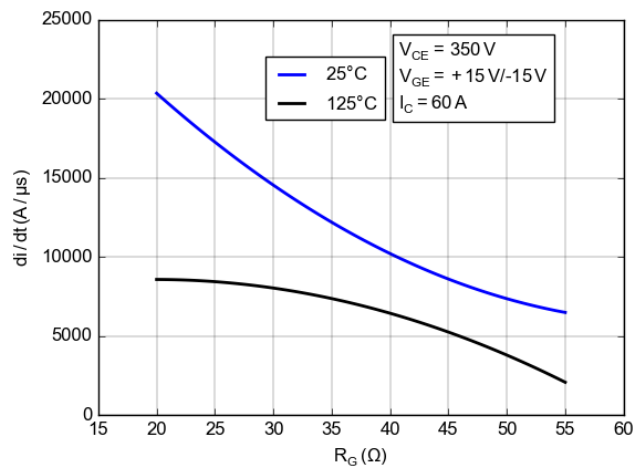

Figure 61. Typical di/dt vs R_G

ORDERING INFORMATION

Orderable Part Number	Marking	Package	Shipping
NXH80T120L3Q0P3G	NXH80T120L3Q0P3G	Q0PACK – Case 180AA (Pb-Free and Halide-Free)	24 Units / Blister Tray
NXH80T120L3Q0S3G	NXH80T120L3Q0S3G	Q0PACK – Case 180AB (Pb-Free and Halide-Free)	24 Units / Blister Tray
NXH80T120L3Q0S3TG	NXH80T120L3Q0S3TG	Q0PACK – Case 180AB with pre-applied thermal interface material (TIM) (Pb-Free and Halide-Free)	24 Units / Blister Tray

MECHANICAL CASE OUTLINE

PACKAGE DIMENSIONS

ON Semiconductor®



PIM20, 55x32.5 / Q0PACK
CASE 180AA
ISSUE D

DATE 07 AUG 2018

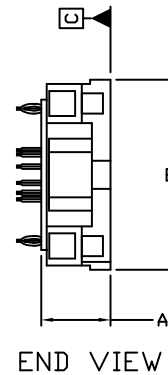
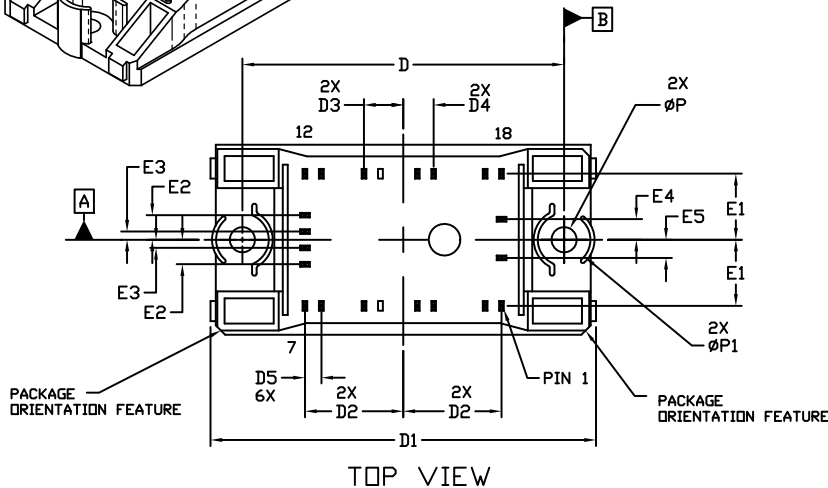
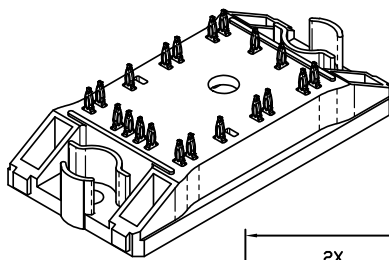

DIM	MILLIMETERS		
	MIN.	NOM.	MAX.
A	11.33	11.83	12.33
A3	15.50	16.00	16.50
A4	12.88 BSC		
b	1.61	1.66	1.71
b1	0.75	0.80	0.85
D	54.80	55.00	55.20
D1	65.70	67.90	70.10
D2	16.80 BSC		
D3	6.70 BSC		
D4	5.20 BSC		
D5	2.80 BSC		
E	32.30	32.50	32.70
E1	11.30 BSC		
E2	4.20 BSC		
E3	1.40 BSC		
E4	3.50 BSC		
E5	3.10 BSC		
P	4.10	4.30	4.50
P1	8.50	9.00	9.50

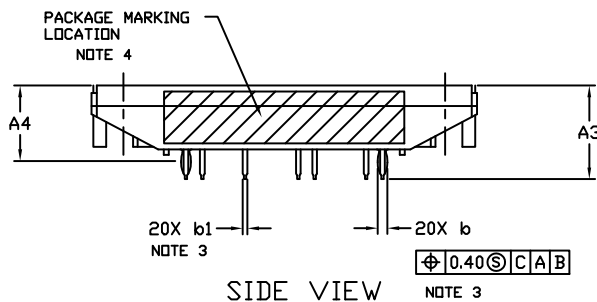

NOTES:

1. DIMENSIONING AND TOLERANCING PER ASME Y14.5M, 2009.
2. CONTROLLING DIMENSION: MILLIMETERS
3. DIMENSIONS b AND b1 APPLY TO THE PLATED TERMINALS AND ARE MEASURED AT DIMENSION A4.
4. PACKAGE MARKING IS LOCATED AS SHOWN ON THE SIDE OPPOSITE THE PACKAGE ORIENTATION FEATURES.

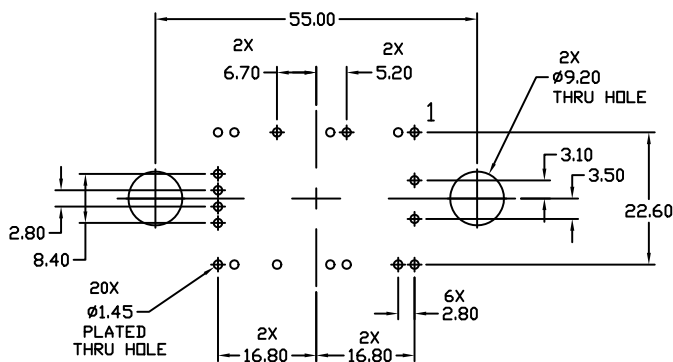

RECOMMENDED MOUNTING PATTERN

GENERIC MARKING DIAGRAM*

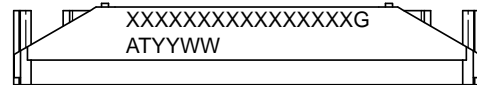

XXXXX = Specific Device Code
 G = Pb-Free Package
 AT = Assembly & Test Site Code
 YYWW = Year and Work Week Code

*This information is generic. Please refer to device data sheet for actual part marking. Pb-Free indicator, "G" or microdot "•", may or may not be present. Some products may not follow the Generic Marking.

DOCUMENT NUMBER:	98AON95859F	Electronic versions are uncontrolled except when accessed directly from the Document Repository. Printed versions are uncontrolled except when stamped "CONTROLLED COPY" in red.
DESCRIPTION:	PIM20, 55x32.5 / Q0PACK	PAGE 1 OF 1

ON Semiconductor and ON are trademarks of Semiconductor Components Industries, LLC dba ON Semiconductor or its subsidiaries in the United States and/or other countries. ON Semiconductor reserves the right to make changes without further notice to any products herein. ON Semiconductor makes no warranty, representation or guarantee regarding the suitability of its products for any particular purpose, nor does ON Semiconductor assume any liability arising out of the application or use of any product or circuit, and specifically disclaims any and all liability, including without limitation special, consequential or incidental damages. ON Semiconductor does not convey any license under its patent rights nor the rights of others.

MECHANICAL CASE OUTLINE

PACKAGE DIMENSIONS

ON Semiconductor®



PIM20, 55x32.5 / Q0PACK CASE 180AB ISSUE D

DATE 21 NOV 2017

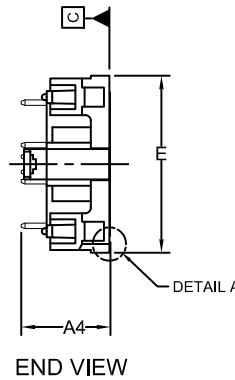
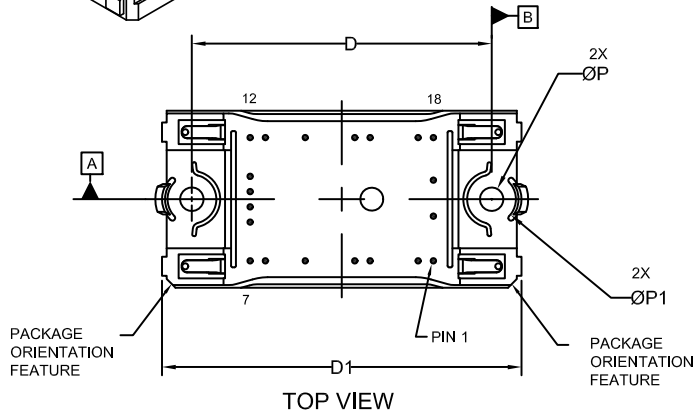
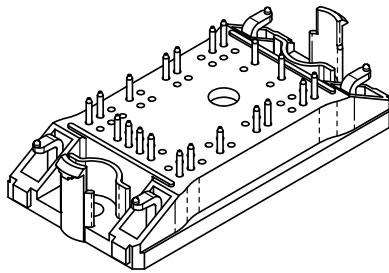

DIM	MILLIMETERS	
	MIN.	NOM.
A	13.50	13.90
A1	0.10	0.30
A2	11.50	11.90
A3	15.65	16.05
A4	16.35 REF	
b	0.95	1.05
D	54.80	55.20
D1	65.60	66.20
E	32.20	32.80
P	4.20	4.40
P1	8.90	9.10

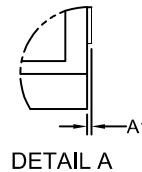
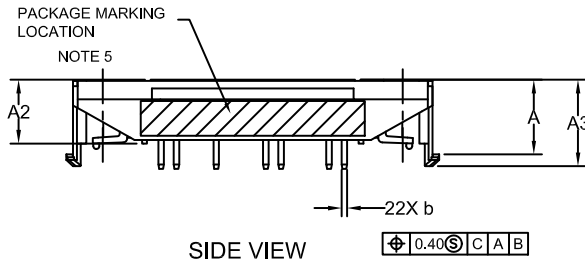

NOTE 4

PIN	PIN POSITION		PIN	PIN POSITION	
	X	Y		X	Y
1	16.80	-11.30	11	-16.80	4.20
2	14.00	-11.30	12	-16.80	11.30
3	5.20	-11.30	13	-14.00	11.30
4	2.40	-11.30	14	-6.70	11.30
5	-6.70	-11.30	15	2.40	11.30
6	-14.00	-11.30	16	5.20	11.30
7	-16.80	-11.30	17	14.00	11.30
8	-16.80	-4.20	18	16.80	11.30
9	-16.80	-1.40	19	16.80	3.50
10	-16.80	1.40	20	16.80	-3.10

NOTES:

- DIMENSIONING AND TOLERANCING PER ASME Y14.5M, 2009.
- CONTROLLING DIMENSION: MILLIMETERS
- DIMENSION b APPLIES TO THE PLATED TERMINALS AND IS MEASURED BETWEEN 1.00 AND 3.00 FROM THE TERMINAL TIP.
- POSITION OF THE CENTER OF THE TERMINALS IS DETERMINED FROM DATUM B THE CENTER OF DIMENSION D, X DIRECTION, AND FROM DATUM A, Y DIRECTION. POSITIONAL TOLERANCE, AS NOTED IN DRAWING, APPLIES TO EACH TERMINAL IN BOTH DIRECTIONS.
- PACKAGE MARKING IS LOCATED AS SHOWN ON THE SIDE OPPOSITE THE PACKAGE ORIENTATION FEATURES.

MOUNTING FOOTPRINT & MARKING DIAGRAM ON PAGE 2

DOCUMENT NUMBER:	98AON98424F	Electronic versions are uncontrolled except when accessed directly from the Document Repository. Printed versions are uncontrolled except when stamped "CONTROLLED COPY" in red.
DESCRIPTION:	PIM20 55X32.5 / Q0PACK (SOLDER PIN)	PAGE 1 OF 2

ON Semiconductor and are trademarks of Semiconductor Components Industries, LLC dba ON Semiconductor or its subsidiaries in the United States and/or other countries. ON Semiconductor reserves the right to make changes without further notice to any products herein. ON Semiconductor makes no warranty, representation or guarantee regarding the suitability of its products for any particular purpose, nor does ON Semiconductor assume any liability arising out of the application or use of any product or circuit, and specifically disclaims any and all liability, including without limitation special, consequential or incidental damages. ON Semiconductor does not convey any license under its patent rights nor the rights of others.

PIM20, 55x32.5 / Q0PACK
CASE 180AB
ISSUE D

DATE 21 NOV 2017

MOUNTING HOLE POSITION

PIN	PIN POSITION		PIN	PIN POSITION	
	X	Y		X	Y
1	16.80	11.30	11	-16.80	-4.20
2	14.00	11.30	12	-16.80	-11.30
3	5.20	11.30	13	-14.00	-11.30
4	2.40	11.30	14	-6.70	-11.30
5	-6.70	11.30	15	2.40	-11.30
6	-14.00	11.30	16	5.20	-11.30
7	-16.80	11.30	17	14.00	-11.30
8	-16.80	4.20	18	16.80	-11.30
9	-16.80	1.40	19	16.80	-3.50
10	-16.80	-1.40	20	16.80	3.10

FOR PCB
THICKNESS 1.45-1.80

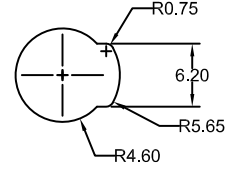

FOR PCB
THICKNESS 1.80-2.20

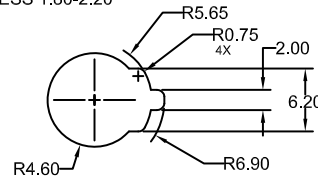

FOR PCB
THICKNESS 2.20-2.80

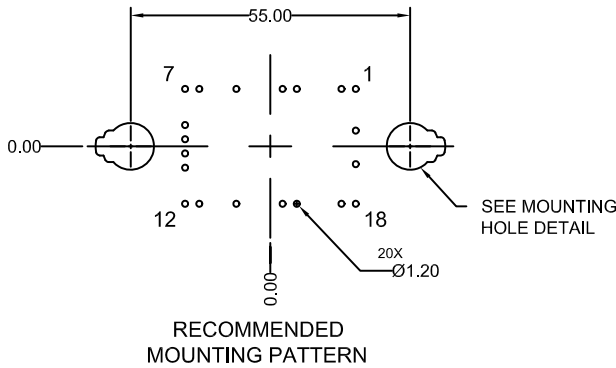
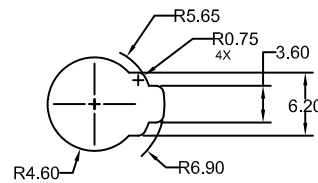

MOUNTING HOLE DETAIL

GENERIC MARKING DIAGRAM*

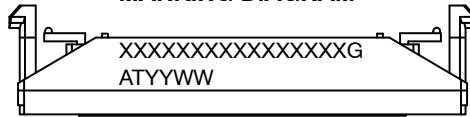

- XXXXX = Specific Device Code
- G = Pb-Free Package
- AT = Assembly & Test Site Code
- YYWW = Year and Work Week Code

*This information is generic. Please refer to device data sheet for actual part marking. Pb-Free indicator, "G" or microdot "▪", may or may not be present. Some products may not follow the Generic Marking.

DOCUMENT NUMBER:	98AON98424F	Electronic versions are uncontrolled except when accessed directly from the Document Repository. Printed versions are uncontrolled except when stamped "CONTROLLED COPY" in red.
DESCRIPTION:	PIM20 55X32.5 / Q0PACK (SOLDER PIN)	PAGE 2 OF 2

ON Semiconductor and  are trademarks of Semiconductor Components Industries, LLC dba ON Semiconductor or its subsidiaries in the United States and/or other countries. ON Semiconductor reserves the right to make changes without further notice to any products herein. ON Semiconductor makes no warranty, representation or guarantee regarding the suitability of its products for any particular purpose, nor does ON Semiconductor assume any liability arising out of the application or use of any product or circuit, and specifically disclaims any and all liability, including without limitation special, consequential or incidental damages. ON Semiconductor does not convey any license under its patent rights nor the rights of others.

onsemi, **Onsemi**, and other names, marks, and brands are registered and/or common law trademarks of Semiconductor Components Industries, LLC dba "**onsemi**" or its affiliates and/or subsidiaries in the United States and/or other countries. **onsemi** owns the rights to a number of patents, trademarks, copyrights, trade secrets, and other intellectual property. A listing of **onsemi**'s product/patent coverage may be accessed at www.onsemi.com/site/pdf/Patent-Marking.pdf. **onsemi** reserves the right to make changes at any time to any products or information herein, without notice. The information herein is provided "as-is" and **onsemi** makes no warranty, representation or guarantee regarding the accuracy of the information, product features, availability, functionality, or suitability of its products for any particular purpose, nor does **onsemi** assume any liability arising out of the application or use of any product or circuit, and specifically disclaims any and all liability, including without limitation special, consequential or incidental damages. Buyer is responsible for its products and applications using **onsemi** products, including compliance with all laws, regulations and safety requirements or standards, regardless of any support or applications information provided by **onsemi**. "Typical" parameters which may be provided in **onsemi** data sheets and/or specifications can and do vary in different applications and actual performance may vary over time. All operating parameters, including "Typicals" must be validated for each customer application by customer's technical experts. **onsemi** does not convey any license under any of its intellectual property rights nor the rights of others. **onsemi** products are not designed, intended, or authorized for use as a critical component in life support systems or any FDA Class 3 medical devices or medical devices with a same or similar classification in a foreign jurisdiction or any devices intended for implantation in the human body. Should Buyer purchase or use **onsemi** products for any such unintended or unauthorized application, Buyer shall indemnify and hold **onsemi** and its officers, employees, subsidiaries, affiliates, and distributors harmless against all claims, costs, damages, and expenses, and reasonable attorney fees arising out of, directly or indirectly, any claim of personal injury or death associated with such unintended or unauthorized use, even if such claim alleges that **onsemi** was negligent regarding the design or manufacture of the part. **onsemi** is an Equal Opportunity/Affirmative Action Employer. This literature is subject to all applicable copyright laws and is not for resale in any manner.

PUBLICATION ORDERING INFORMATION

LITERATURE FULFILLMENT:

Email Requests to: orderlit@onsemi.com

onsemi Website: www.onsemi.com

TECHNICAL SUPPORT

North American Technical Support:
Voice Mail: 1 800-282-9855 Toll Free USA/Canada
Phone: 011 421 33 790 2910

Europe, Middle East and Africa Technical Support:

Phone: 00421 33 790 2910

For additional information, please contact your local Sales Representative