



Automotive Power Common Mode Chokes

ACMP-Q2012

Request Samples



Check Inventory



2.0 x 1.2 x 1.2 mm
RoHS/RoHS II Compliant
MSL Level = 1

Features

- AEC-Q200 compliant, Grade 1
- PPAP ready and supported
- Manufactured in TS/IATF 16949 production lines
- Excellent impedance characteristics
- Rated current up to 0.4A

Applications

- DC power line common mode noise suppression.
- Multimedia devices
- Automotive power train
- Automotive infotainment

Electrical Specifications

Part Number	Impedance (Ω) $\pm 25\%$ @100MHz	DCR (m Ω)	Rated Current (A)	Rated Voltage (Vdc)	Insulation Resistance (M Ω)
		Max	Max	Max	Min
ACMP-Q2012-670	67	250	0.4	50	10
ACMP-Q2012-900	90	300	0.4	50	10
ACMP-Q2012-121	120	300	0.4	50	10
ACMP-Q2012-161	160	350	0.35	50	10
ACMP-Q2012-181	180	350	0.35	50	10
ACMP-Q2012-201	200	400	0.3	50	10
ACMP-Q2012-221	220	400	0.3	50	10
ACMP-Q2012-261	260	400	0.3	50	10
ACMP-Q2012-361	360	500	0.3	50	10

Rated Current is based on an Irms temperature rise of 40°C

ACMP-Q2012 is AEC-Q200 Automotive certified

ACMP-Q2012 Series is RoHS Compliant and Pb free

Operating Temperature: -55°C to +125°C (Including self-heating)

Storage Temperature (on PCB): -55°C to +125°C

Storage (in original packaging): <40°C, <60% RH



5101 Hidden Creek Ln, Spicewood TX 78669
Phone: 512-371-6159 Fax: 512-351-8858
For terms and conditions of sales, please visit:
www.abracon.com

REVISION Initial Release
3/31/2022

ABRACON IS
ISO9001-2015
CERTIFIED



Automotive Power Common Mode Chokes

ACMP-Q2012

Request Samples



Check Inventory



2.0 x 1.2 x 1.2 mm
RoHS/RoHS II Compliant
MSL Level = 1

Electrical Specifications

ACMP-Q2012-670-T

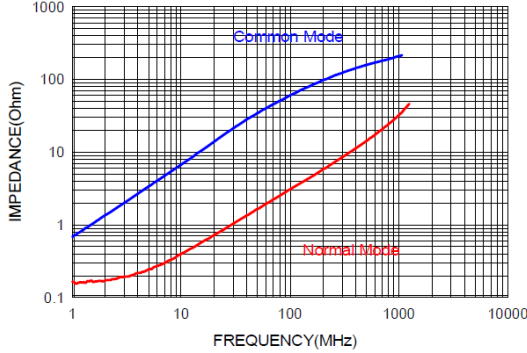

ACMP-Q2012-900-T

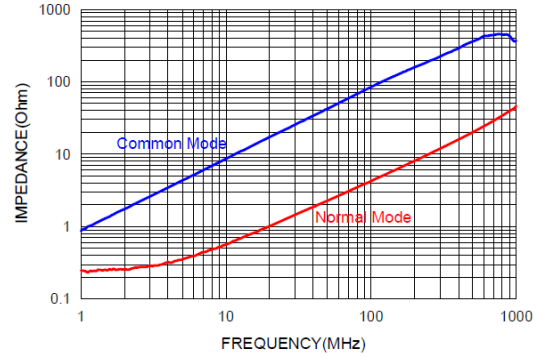

ACMP-Q2012-121-T

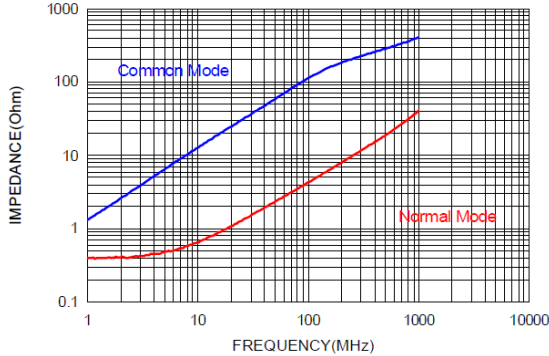

ACMP-Q2012-161-T

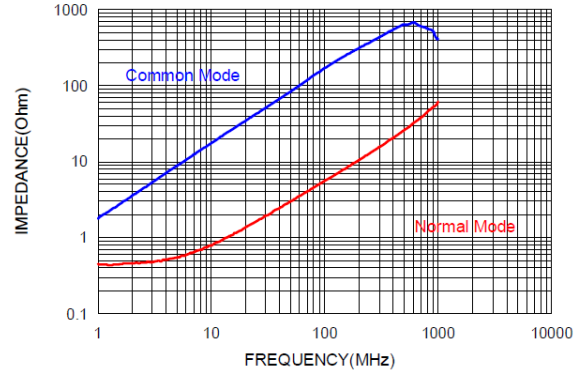

ACMP-Q2012-181-T

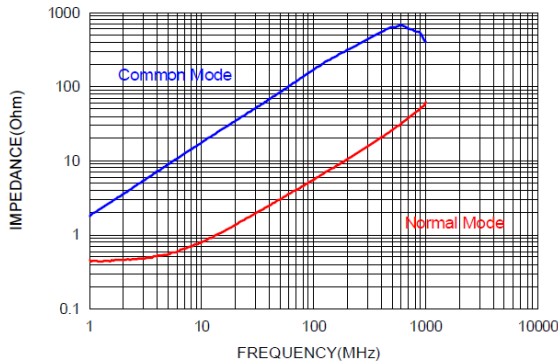

ACMP-Q2012-201-T

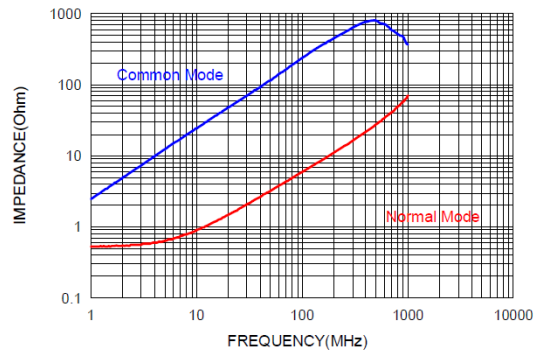



Automotive Power Common Mode Chokes

ACMP-Q2012

Request Samples



Check Inventory



2.0 x 1.2 x 1.2 mm
RoHS/RoHS II Compliant
MSL Level = 1

Electrical Specifications

ACMP-Q2012-221-T

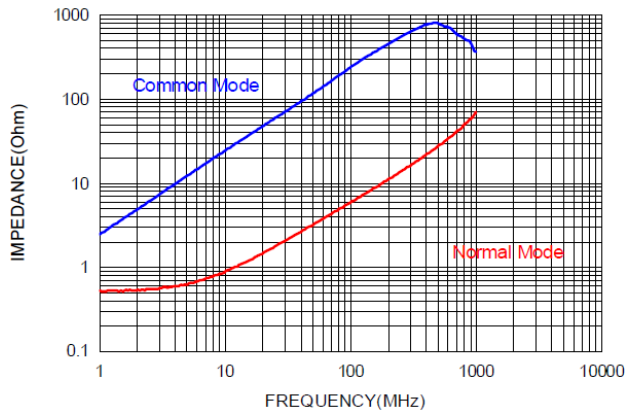

ACMP-Q2012-261-T

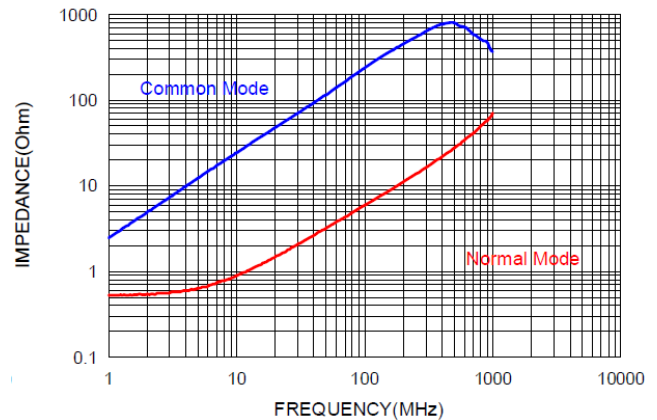

ACMP-Q2012-361-T

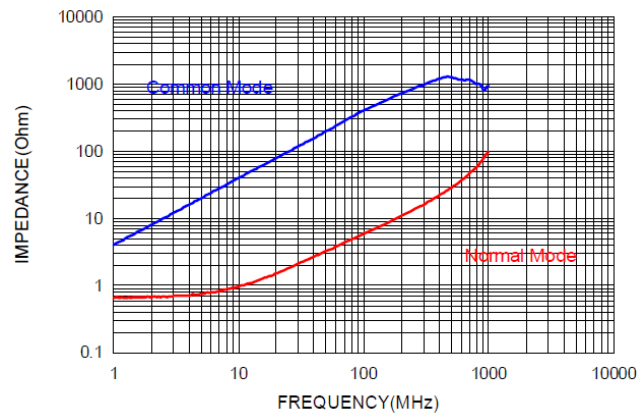

5101 Hidden Creek Ln, Spicewood TX 78669
Phone: 512-371-6159 Fax: 512-351-8858
For terms and conditions of sales, please visit:
www.abracon.com

REVISION Initial Release
3/31/2022

ABRACON IS
ISO9001-2015
CERTIFIED



Automotive Power Common Mode Chokes

ACMP-Q2012

Request Samples



Check Inventory



2.0 x 1.2 x 1.2 mm
 RoHS/RoHS II Compliant
 MSL Level = 1

Mechanical Specifications

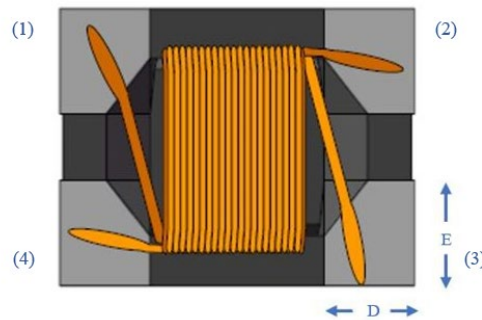
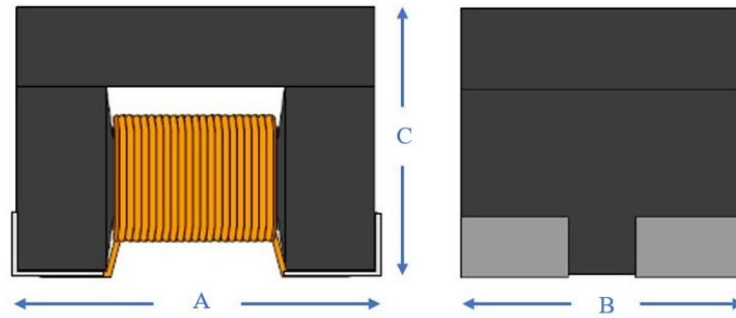

A	B	C	D	E
2.0 ±0.2	1.2 ±0.2	1.2 ±0.2	0.50 ±0.1	0.51 ±0.1

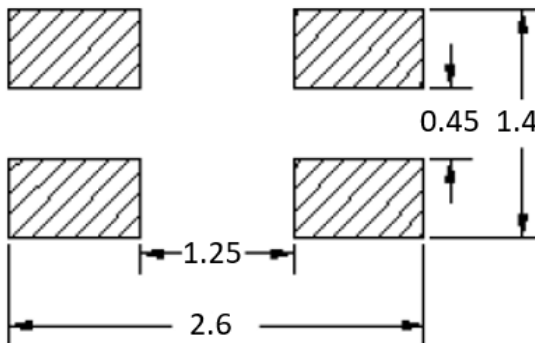

Recommended Layout

Dimensions: mm



5101 Hidden Creek Ln, Spicewood TX 78669
 Phone: 512-371-6159 Fax: 512-351-8858
 For terms and conditions of sales, please visit:
www.abracon.com

REVISION Initial Release
 3/31/2022

ABRACON IS
 ISO9001-2015
 CERTIFIED



Automotive Power Common Mode Chokes

ACMP-Q2012

Request Samples



Check Inventory



2.0 x 1.2 x 1.2 mm
RoHS/RoHS II Compliant
 MSL Level = 1

Schematic

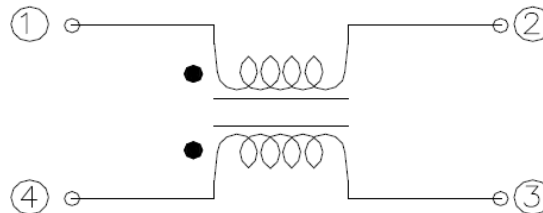

Materials

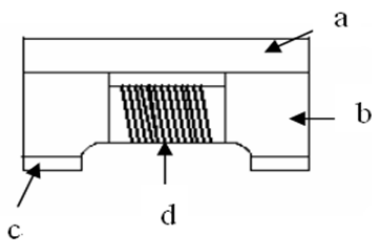

No.	Description	Specification
a	Upper Plate	Ferrite
b	Core	Ferrite Core
c	Electrode	Ag/Ni/Sn
d	Wire	Enameled Copper Wire

Part Identification

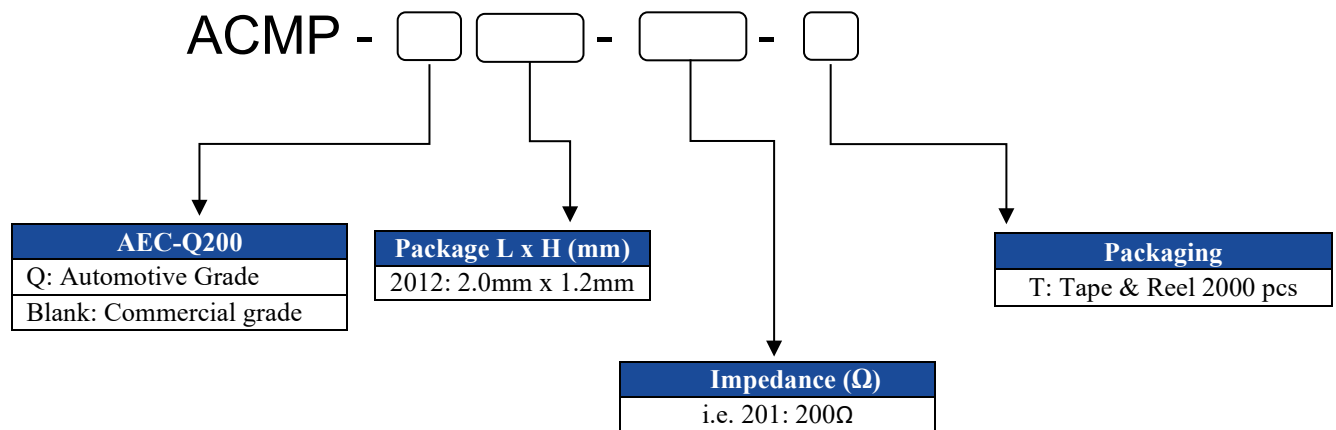



Automotive Power Common Mode Chokes

ACMP-Q2012

Request Samples



Check Inventory



2.0 x 1.2 x 1.2 mm
 RoHS/RoHS II Compliant
 MSL Level = 1

Reflow Profile

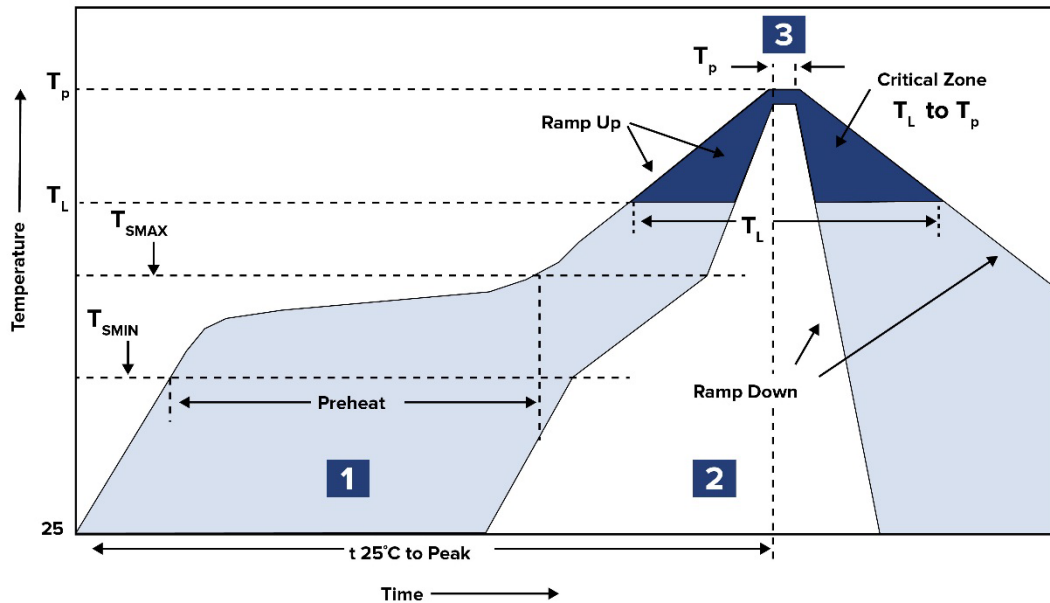

Zone	Description	Temperature	Times
1	Preheat	$T_{SMIN} \sim T_{SMAX}$ 150°C ~ 200°C	60 ~ 180 sec.
2	Reflow	T_L 217°C	60 ~ 150 sec.
3	Peak heat	T_p 260°C MAX	10 sec. MAX



Automotive Power Common Mode Chokes

ACMP-Q2012

Request Samples



Check Inventory



2.0 x 1.2 x 1.2 mm
RoHS/RoHS II Compliant
MSL Level = 1

Packaging

Tape & Reel: 2000pcs/reel

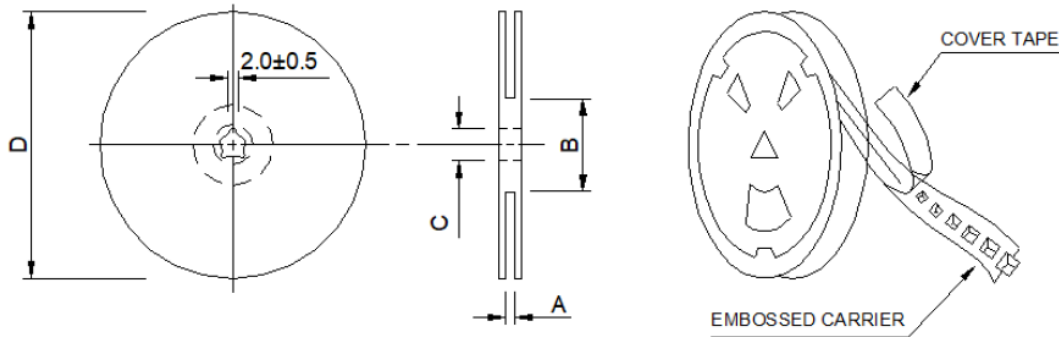

Series	A	B	C	D
ACMP-Q2012	9.0 ±0.5	60.0 ±2.0	13.5 ±0.5	178.0 ±2.0

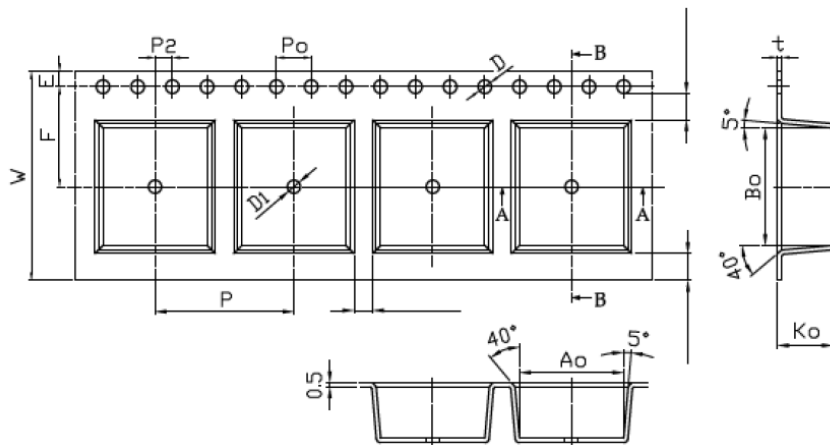

W	P	E	F	P0	P2	Bo	Ao	Ko	D	D1	t
8.0 ±0.10	4 ±0.10	1.75 ±0.10	3.5 ±0.10	4.0 ±0.10	2.0 ±0.10	2.35 ±0.10	1.5 ±0.10	1.45 ±0.10	1.5 +0.10/-0	1.0 ±0.10	0.28 ±0.05

Dimensions: mm

ATTENTION: Abracon LLC's products are COTS – Commercial-Off-The-Shelf products; suitable for Commercial, Industrial and, where designated, Automotive Applications. Abracon's products are not specifically designed for Military, Aviation, Aerospace, Life-dependent Medical applications or any application requiring high reliability where component failure could result in loss of life and/or property. For applications requiring high reliability and/or presenting an extreme operating environment, written consent and authorization from Abracon LLC is required. Please contact Abracon LLC for more information.



5101 Hidden Creek Ln, Spicewood TX 78669
 Phone: 512-371-6159 Fax: 512-351-8858
 For terms and conditions of sales, please visit:
www.abracon.com

REVISION Initial Release
3/31/2022

ABRACON IS
 ISO9001-2015
 CERTIFIED