

**TWIN POWER SILENT  
AUTOMOTIVE RELAY**

**CR RELAYS**

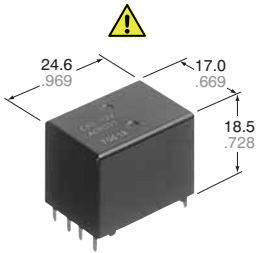



mm inch

**FEATURES**

- **Silent**  
Noise has been reduced by approximately 20 dB, using our own silencing design.
- **Twin (1 Form C × 2)**  
Forward/reverse motor control is possible with a single relay.

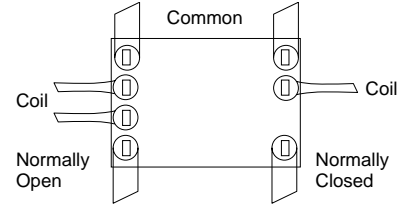
- **Sealed construction**
- Simple footprint enable ease of PC board layout



 Product is discontinued.

**SPECIFICATIONS**

**Contact**

Arrangement	1 Form C × 2		
Contact material	Ag alloy (Cadmium free)		
Initial contact resistance (Initial) (By voltage drop 6 V DC 1A)	Typ. 6 mΩ (N.O.) Typ. 9 mΩ (N.C.)		
Contact voltage drop	Max. 0.2V (at 10 A)		
Rating	Nominal switching capacity	N.O.: 20 A 14 V DC N.C.: 10 A 14 V DC	
	Max. carrying current	35 A for 2 minutes, 25 A for 1 hour (12 V, at 20°C/68°F) 30 A for 2 minutes, 20 A for 1 hour (12 V, at 85°C/185°F)	
	Min. switching capacity <sup>#1</sup>	1 A 12 V DC	
Expected life (min. operations)	Mechanical (at 120 cpm)	Min. 10 <sup>7</sup>	
	Electrical	Resistive load	Min. 10 <sup>5*1</sup>
		Motor load	Min. 2×10 <sup>5*2</sup> Min. 10 <sup>5*3</sup>

#1 This value can change due to the switching frequency, environmental conditions, and desired reliability level, therefore it is recommended to check this with the actual load.

**Characteristics**

Max. operating speed (at nominal switching capacity)	6 cpm	
Initial insulation resistance* <sup>4</sup>	Min. 100 MΩ (at 500 V DC)	
Initial breakdown voltage* <sup>5</sup>	Between open contacts	500 Vrms for 1 min.
	Between contacts and coil	500 Vrms for 1 min.
Operate time* <sup>6</sup> (at nominal voltage)(at 20°C/68°F)	Max. 10 ms (initial)	
Release time* <sup>6</sup> (at nominal voltage)(at 20°C/68°F)	Max. 10 ms (initial)	
Shock resistance	Functional* <sup>7</sup>	Min. 100 m/s <sup>2</sup> {10G}
	Destructive* <sup>8</sup>	Min. 1,000 m/s <sup>2</sup> {100G}
Vibration resistance	Functional* <sup>9</sup>	10 Hz to 100 Hz, Min. 44.1 m/s <sup>2</sup> {4.5G}
	Destructive* <sup>10</sup>	10 Hz to 500 Hz, Min. 44.1 m/s <sup>2</sup> {4.5G}

**Coil**

Nominal operating power	640 mW	
Conditions for operation, transport and storage* <sup>11</sup> (Not freezing and condensing at low temperature)	Ambient temperature	-40°C to +85°C -40°F to +185°F
	Humidity	5% R.H. to 85% R.H.
Mass	Approx. 12.5g.44 oz	

**Remarks**

**TYPICAL APPLICATIONS**

- Power windows
- Auto door lock
- Electrically powered sunroof
- Electrically powered mirror, etc.

**ORDERING INFORMATION**

Ex. CR 2 - 12 V

Contact arrangement	Coil voltage(DC)
1 Form C × 2	12 V

Standard packing: Carton(tube package) 32pcs. Case: 800pcs.

## TYPES AND COIL DATA (at 20°C 68°F)

Part No.	Nominal voltage, V DC	Pick-up voltage, V DC (Initial)*	Drop-out voltage, V DC (Initial)	Coil resistance, Ω	Nominal operating current, mA	Nominal operating power, mW	Usable voltage range, V DC
CR2-12V	12	Max. 7.2	Min. 1.0	225±10%	53.3±10%	640	10 to 16

\* Other pick-up voltage types are also available. Please contact us for details.

## DIMENSIONS

mm inch

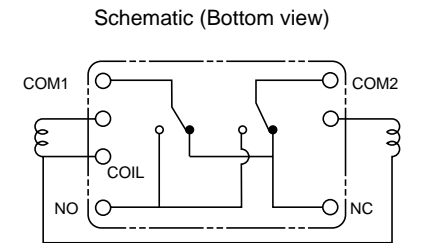
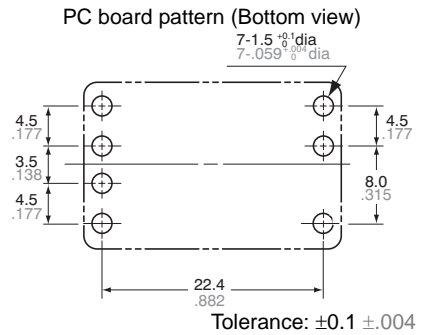
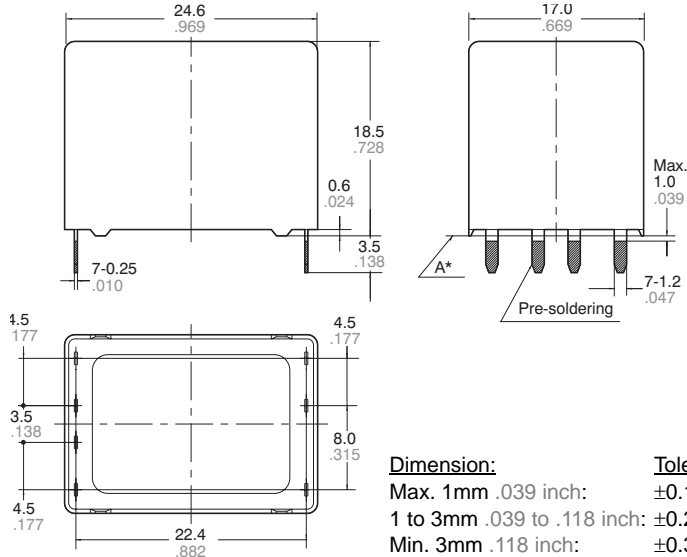

\* Dimensions (thickness and width) of terminal specified in this catalog is measured before pre-soldering. Intervals between terminals is measured at A surface level.

## EXAMPLE OF CIRCUIT

Forward/reverse control circuits of DC motor for power window

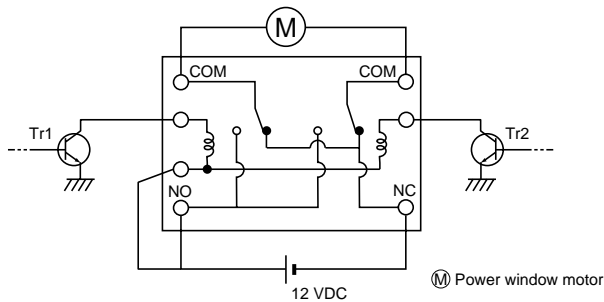

Tr1	Tr2	Motor
OFF	OFF	Stop
ON	OFF	Forward
OFF	ON	Reverse

**REFERENCE DATA**

1-(1). Coil temperature rise (at room temperature)  
 Sample: CR2-12V, 5pcs  
 Contact carrying current: 10A, 15A, 20A  
 Ambient temperature: Room temperature

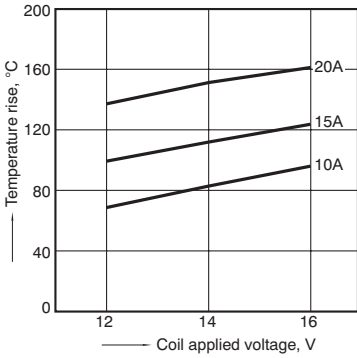

1-(2). Coil temperature rise (at 85°C 185°F)  
 Sample: CR2-12V, 5pcs  
 Contact carrying current: 10A, 15A  
 Ambient temperature: 85°C 185°F

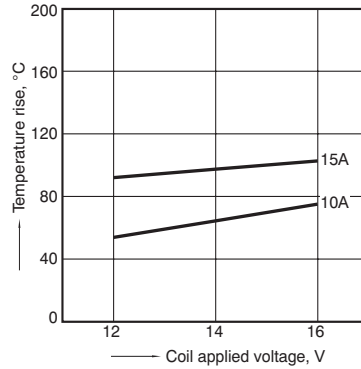

2. Max. switching capability (Resistive load, initial)

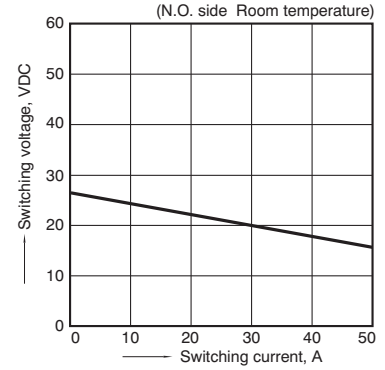

3. Ambient temperature and operating temperature range

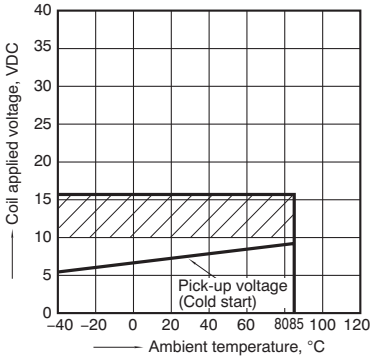

4. Ambient temperature characteristics

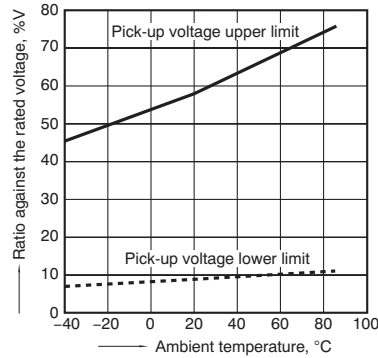

5. Distribution of pick-up and drop-out voltage  
 Sample: CR2-12V, 100pcs

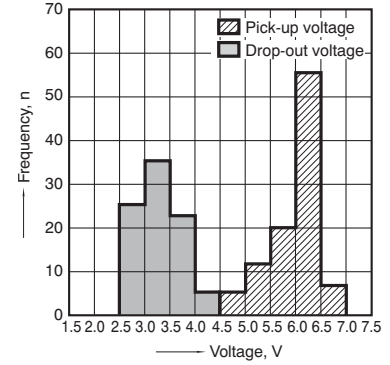

6. Distribution of operate time  
 Sample: CR2-12V, 100pcs

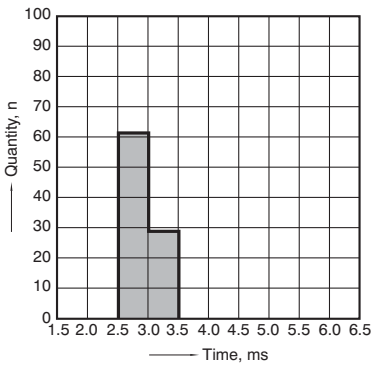

7. Distribution of release time  
 Sample: CR2-12V, 100pcs  
 \* With diode

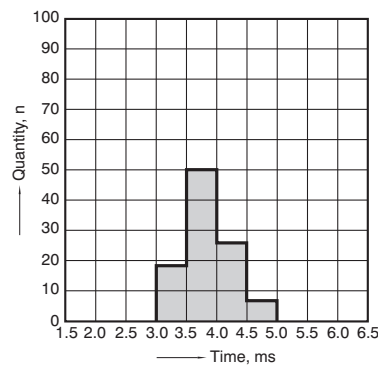

8-(1). Operation noise distribution  
 When operated

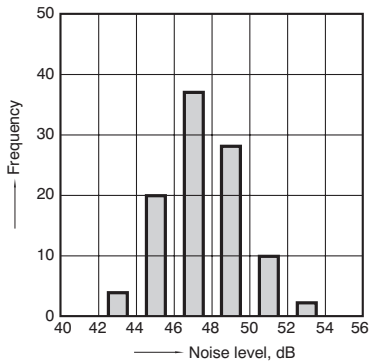

8-(2). Operation noise distribution  
 When released

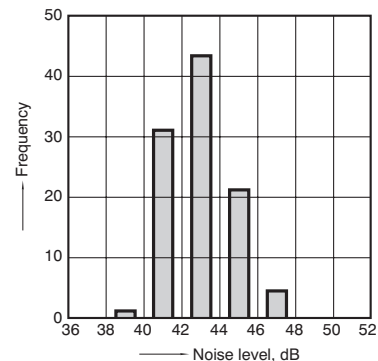

Measuring conditions

Sample: CR2-12 V, 50 pcs.  
 Equipment setting: "A" weighted, Fast, Max. hold  
 Coil voltage: 12V DC  
 Coil connection device: Diode  
 Background noise: Approx. 20dB

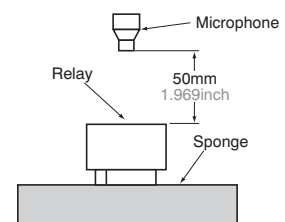

**9-(1). Electrical life test (Motor free)**

Sample: CR2-12V, 3pcs  
 Load: Inrush current: 25A, Steady current: 6A,  
 Brake current: 15A,  
 power window motor actual load (free condition)  
 Tested voltage: 14V DC  
 Ambient temperature: Room temperature

**Circuit**

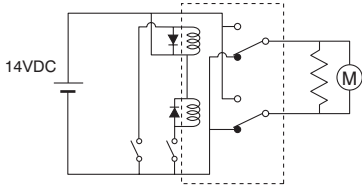

**Change of pick-up and drop-out voltage**

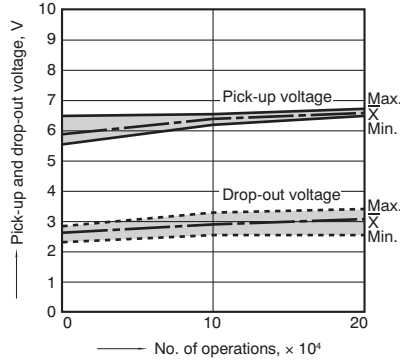

**Change of contact resistance**

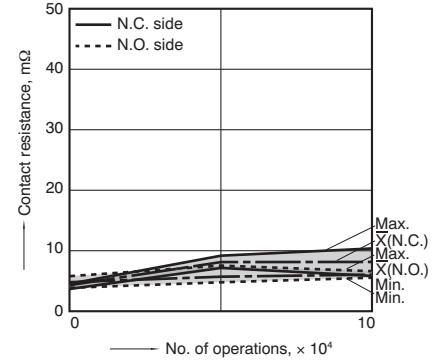

**Load current waveform**

Inrush current: 25A, Steady current: 6A,  
 Brake current: 15A  
 Tested voltage: 14V DC

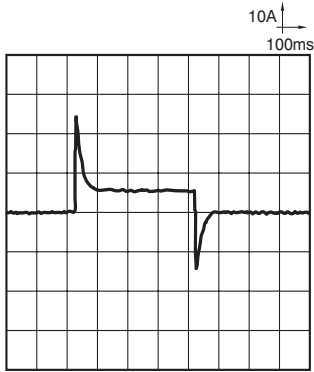

**9-(2). Electrical life test (Motor lock)**

Sample: CR2-12V, 3pcs  
 Brake current: 22A,  
 power window motor actual load (lock condition)  
 Tested voltage: 14V DC  
 Switching frequency: (ON:OFF = 0.5s:9.5s)  
 Ambient temperature: Room temperature

**Circuit**

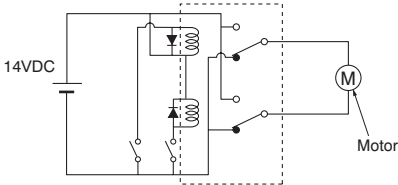

**Change of pick-up and drop-out voltage**

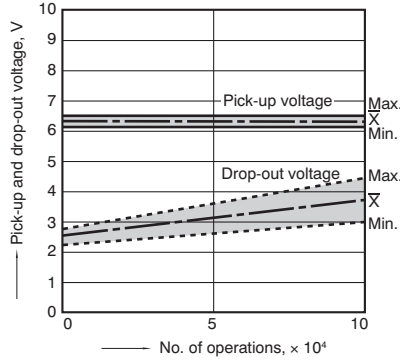

**Change of contact resistance**

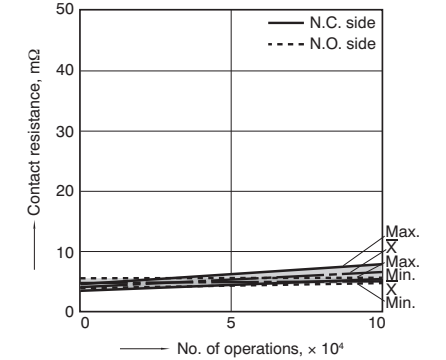

**Load current waveform**

Brake current: 22A  
 Tested voltage: 14V DC

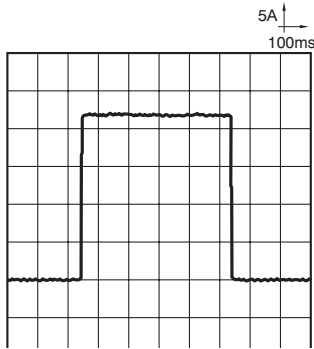

**For Cautions for Use, see [Relay Technical Information](#).**