



PSMN005-75B

N-channel TrenchMOS SiliconMAX standard level FET

Rev. 01 — 16 November 2009

Product data sheet

1. Product profile

1.1 General description

SiliconMAX standard level N-channel enhancement mode Field-Effect Transistor (FET) in a plastic package using TrenchMOS technology. This product is designed and qualified for use in computing, communications, consumer and industrial applications only.

1.2 Features and benefits

- Low conduction losses due to low on-state resistance
- Suitable for high frequency applications due to fast switching characteristics

1.3 Applications

- High frequency computer motherboard DC-to-DC convertors
- OR-ing applications

1.4 Quick reference data

Table 1. Quick reference

Symbol	Parameter	Conditions	Min	Typ	Max	Unit
V_{DS}	drain-source voltage	$T_j \geq 25\text{ °C}; T_j \leq 175\text{ °C}$	-	-	75	V
I_D	drain current	$T_{mb} = 25\text{ °C}; V_{GS} = 10\text{ V};$ see Figure 1 and 3	-	-	75	A
P_{tot}	total power dissipation	$T_{mb} = 25\text{ °C};$ see Figure 2	-	-	230	W
Dynamic characteristics						
Q_{GD}	gate-drain charge	$V_{GS} = 10\text{ V}; I_D = 75\text{ A};$ $V_{DS} = 60\text{ V}; T_j = 25\text{ °C};$ see Figure 11	-	50	-	nC
Static characteristics						
R_{DSon}	drain-source on-state resistance	$V_{GS} = 10\text{ V}; I_D = 25\text{ A};$ $T_j = 25\text{ °C};$ see Figure 9 and 10	-	4.3	5	m Ω

2. Pinning information

Table 2. Pinning information

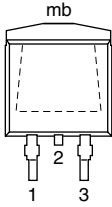
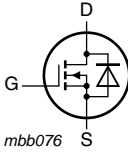
Pin	Symbol	Description	Simplified outline	Graphic symbol
1	G	gate	 <p>SOT404 (D2PAK)</p>	
2	D	drain [1]		
3	S	source		
mb	D	drain		

[1] It is not possible to make connection to pin 2.

3. Ordering information

Table 3. Ordering information

Type number	Package		Version
	Name	Description	
PSMN005-75B	D2PAK	plastic single-ended surface-mounted package (D2PAK); 3 leads (one lead cropped)	SOT404

4. Limiting values

Table 4. Limiting values

In accordance with the Absolute Maximum Rating System (IEC 60134).

Symbol	Parameter	Conditions	Min	Max	Unit
V_{DS}	drain-source voltage	$T_j \geq 25\text{ °C}$; $T_j \leq 175\text{ °C}$	-	75	V
V_{DGR}	drain-gate voltage	$T_j \leq 175\text{ °C}$; $T_j \geq 25\text{ °C}$; $R_{GS} = 20\text{ k}\Omega$	-	75	V
V_{GS}	gate-source voltage		-20	20	V
I_D	drain current	$V_{GS} = 10\text{ V}$; $T_{mb} = 100\text{ °C}$; see Figure 1	-	75	A
		$V_{GS} = 10\text{ V}$; $T_{mb} = 25\text{ °C}$; see Figure 1 and 3	-	75	A
I_{DM}	peak drain current	$t_p \leq 10\text{ }\mu\text{s}$; pulsed; $T_{mb} = 25\text{ °C}$; see Figure 3	-	400	A
P_{tot}	total power dissipation	$T_{mb} = 25\text{ °C}$; see Figure 2	-	230	W
T_{stg}	storage temperature		-55	175	°C
T_j	junction temperature		-55	175	°C
V_{GSM}	peak gate-source voltage	pulsed; $t_p \leq 50\text{ }\mu\text{s}$; $\delta \leq 25\%$; $T_j \leq 150\text{ °C}$	-30	30	V

Source-drain diode					
I_S	source current	$T_{mb} = 25\text{ °C}$	-	75	A
I_{SM}	peak source current	$t_p \leq 10\text{ }\mu\text{s}$; pulsed; $T_{mb} = 25\text{ °C}$	-	400	A

Avalanche ruggedness					
$E_{DS(AL)S}$	non-repetitive drain-source avalanche energy	$V_{GS} = 10\text{ V}$; $T_{j(\text{init})} = 25\text{ °C}$; $I_D = 75\text{ A}$; $V_{sup} = 15\text{ V}$; unclamped; $t_p = 0.1\text{ ms}$; $R_{GS} = 50\text{ }\Omega$	-	500	mJ
$I_{DS(AL)S}$	non-repetitive drain-source avalanche current	$V_{GS} = 10\text{ V}$; $V_{sup} = 15\text{ V}$; $R_{GS} = 50\text{ }\Omega$; $T_{j(\text{init})} = 25\text{ °C}$; unclamped	-	75	A

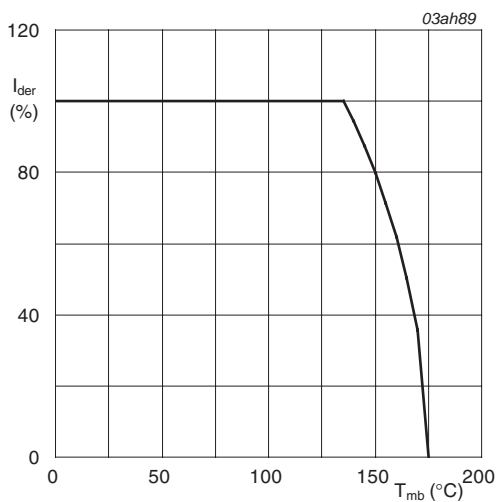

$$I_{der} = \frac{I_D}{I_{D(25^\circ\text{C})}} \times 100\%$$

Fig 1. Normalized continuous drain current as a function of mounting base temperature

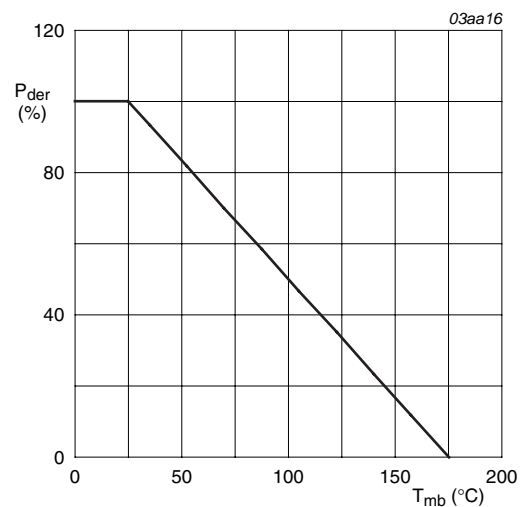

$$P_{der} = \frac{P_{tot}}{P_{tot(25^\circ\text{C})}} \times 100\%$$

Fig 2. Normalized total power dissipation as a function of mounting base temperature

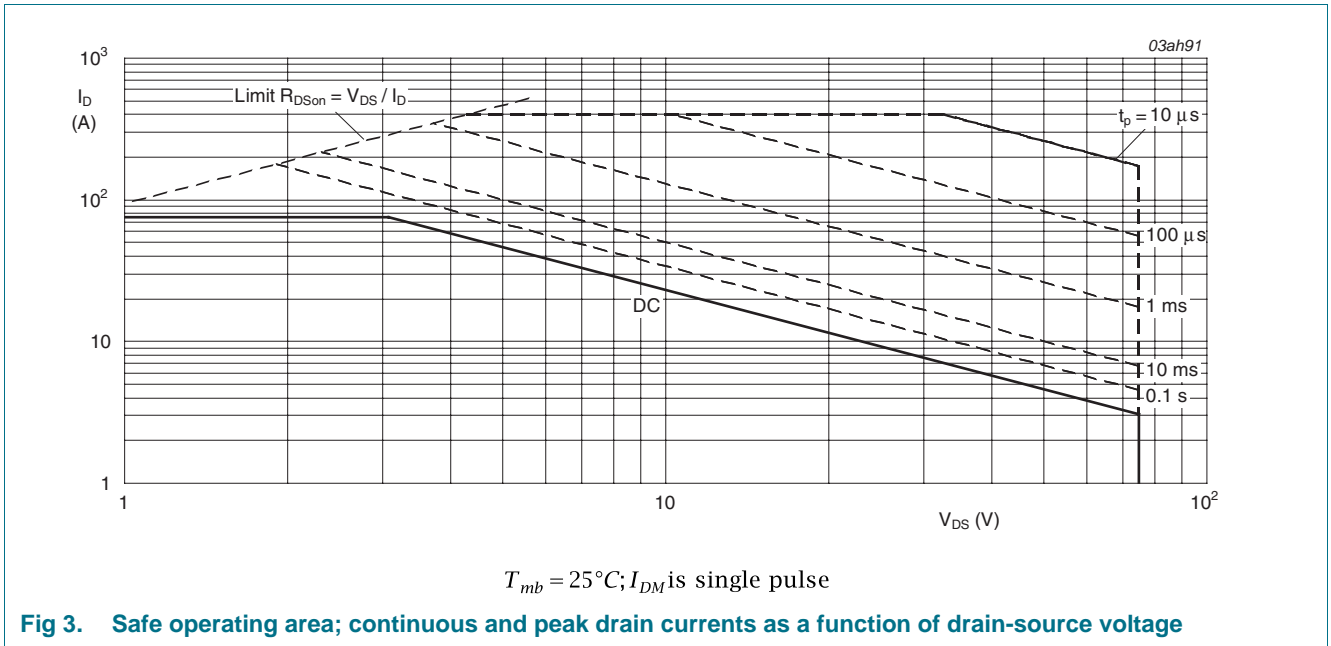

5. Thermal characteristics

Table 5. Thermal characteristics

Symbol	Parameter	Conditions	Min	Typ	Max	Unit
$R_{th(j-mb)}$	thermal resistance from junction to mounting base	see Figure 4	-	-	0.65	K/W
$R_{th(j-a)}$	thermal resistance from junction to ambient	mounted on a printed-circuit board; minimum footprint	-	50	-	K/W

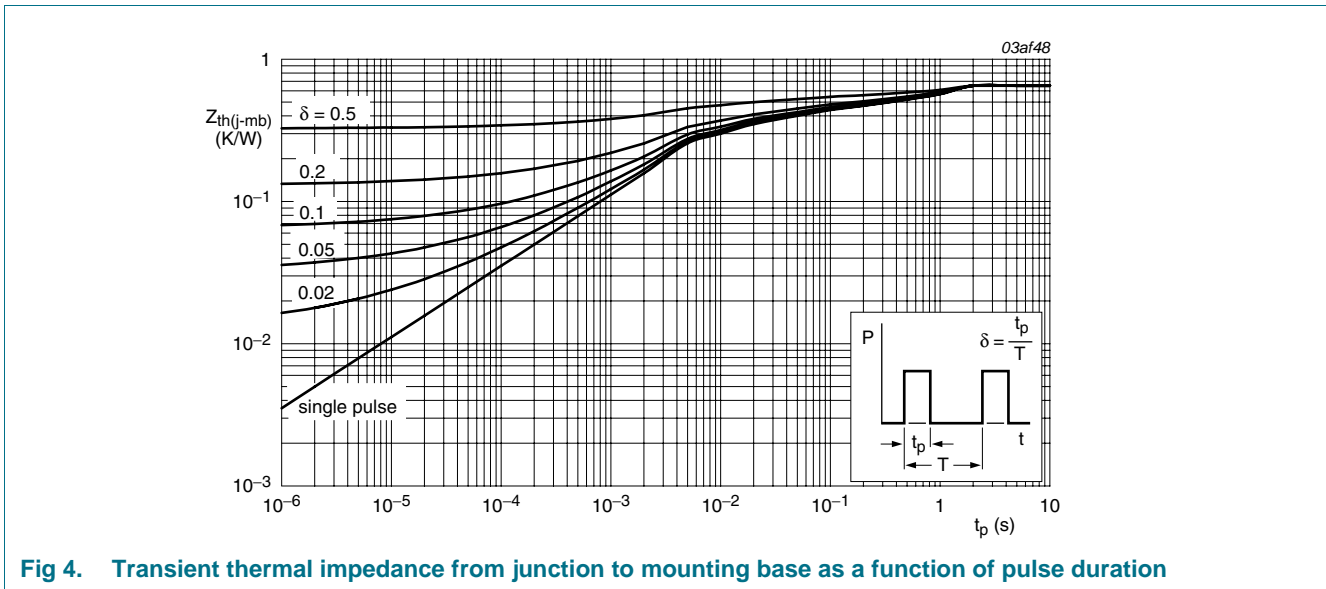

Fig 4. Transient thermal impedance from junction to mounting base as a function of pulse duration

6. Characteristics

Table 6. Characteristics

Symbol	Parameter	Conditions	Min	Typ	Max	Unit
Static characteristics						
$V_{(BR)DSS}$	drain-source breakdown voltage	$I_D = 0.25 \text{ mA}; V_{GS} = 0 \text{ V}; T_j = -55 \text{ }^\circ\text{C}$	67	-	-	V
		$I_D = 0.25 \text{ mA}; V_{GS} = 0 \text{ V}; T_j = 25 \text{ }^\circ\text{C}$	75	-	-	V
$V_{GS(th)}$	gate-source threshold voltage	$I_D = 1 \text{ mA}; V_{DS} = V_{GS}; T_j = 175 \text{ }^\circ\text{C};$ see Figure 8	1	-	-	V
		$I_D = 1 \text{ mA}; V_{DS} = V_{GS}; T_j = 25 \text{ }^\circ\text{C};$ see Figure 8	2	3	4	V
		$I_D = 1 \text{ mA}; V_{DS} = V_{GS}; T_j = -55 \text{ }^\circ\text{C};$ see Figure 8	-	-	4.4	V
I_{DSS}	drain leakage current	$V_{DS} = 75 \text{ V}; V_{GS} = 0 \text{ V}; T_j = 25 \text{ }^\circ\text{C}$	-	0.02	1	μA
		$V_{DS} = 75 \text{ V}; V_{GS} = 0 \text{ V}; T_j = 175 \text{ }^\circ\text{C}$	-	-	500	μA
I_{GSS}	gate leakage current	$V_{GS} = 20 \text{ V}; V_{DS} = 0 \text{ V}; T_j = 25 \text{ }^\circ\text{C}$	-	10	100	nA
		$V_{GS} = -20 \text{ V}; V_{DS} = 0 \text{ V}; T_j = 25 \text{ }^\circ\text{C}$	-	10	100	nA
$R_{DS(on)}$	drain-source on-state resistance	$V_{GS} = 10 \text{ V}; I_D = 25 \text{ A}; T_j = 175 \text{ }^\circ\text{C};$ see Figure 9 and 10	-	9.25	10.75	m Ω
		$V_{GS} = 10 \text{ V}; I_D = 25 \text{ A}; T_j = 25 \text{ }^\circ\text{C};$ see Figure 9 and 10	-	4.3	5	m Ω
Dynamic characteristics						
$Q_{G(tot)}$	total gate charge	$I_D = 75 \text{ A}; V_{DS} = 60 \text{ V}; V_{GS} = 10 \text{ V};$ $T_j = 25 \text{ }^\circ\text{C};$ see Figure 11	-	165	-	nC
Q_{GS}	gate-source charge		-	32	-	nC
Q_{GD}	gate-drain charge		-	50	-	nC
C_{iss}	input capacitance	$V_{DS} = 25 \text{ V}; V_{GS} = 0 \text{ V}; f = 1 \text{ MHz};$ $T_j = 25 \text{ }^\circ\text{C};$ see Figure 12	-	8250	-	pF
C_{oss}	output capacitance		-	920	-	pF
C_{rss}	reverse transfer capacitance		-	470	-	pF
$t_{d(on)}$	turn-on delay time	$V_{DS} = 15 \text{ V}; R_L = 1.25 \text{ } \Omega; V_{GS} = 10 \text{ V};$ $R_{G(ext)} = 6 \text{ } \Omega; T_j = 25 \text{ }^\circ\text{C}$	-	37	-	ns
t_r	rise time		-	73	-	ns
$t_{d(off)}$	turn-off delay time		-	144	-	ns
t_f	fall time		-	74	-	ns
Source-drain diode						
V_{SD}	source-drain voltage	$I_S = 25 \text{ A}; V_{GS} = 0 \text{ V}; T_j = 25 \text{ }^\circ\text{C};$ see Figure 13	-	0.8	1.2	V

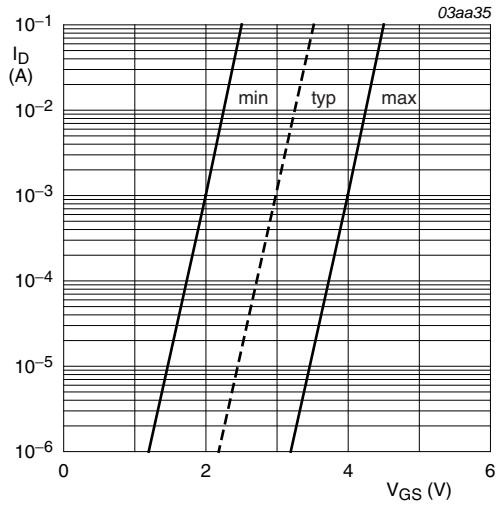

Fig 5. Sub-threshold drain current as a function of gate-source voltage

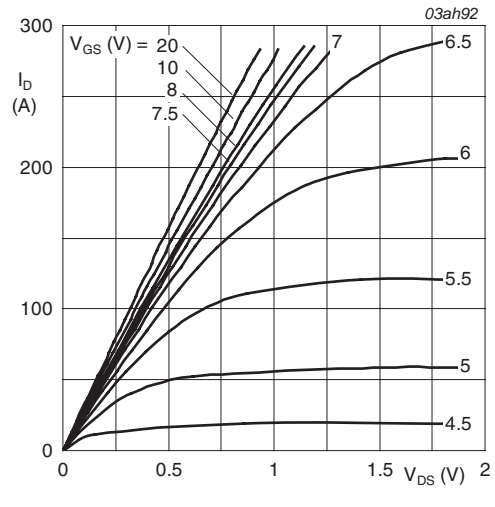

Fig 6. Output characteristics: drain current as a function of drain-source voltage; typical values

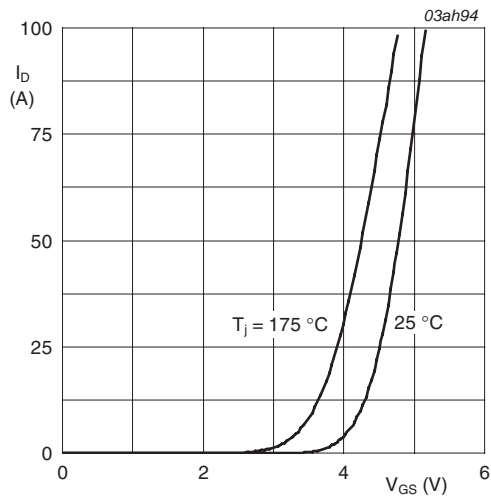

Fig 7. Transfer characteristics: drain current as a function of gate-source voltage; typical values

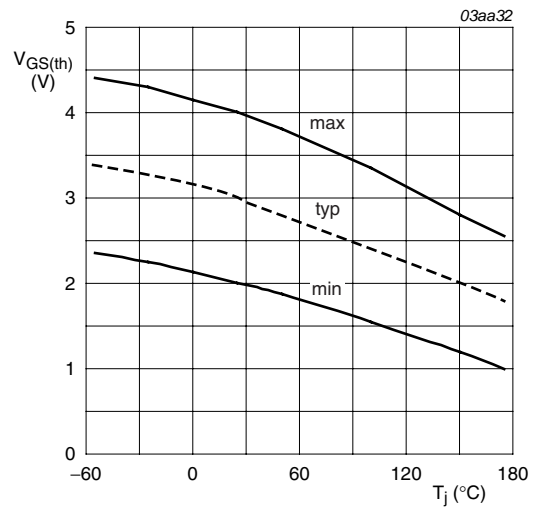
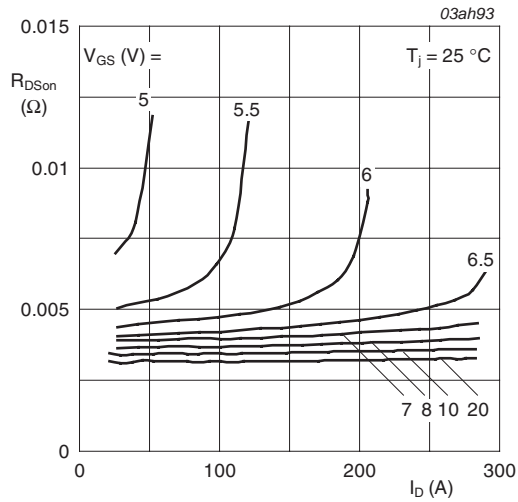
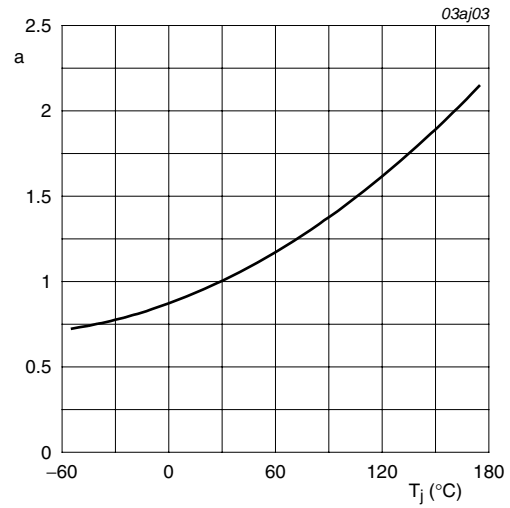

Fig 8. Gate-source threshold voltage as a function of junction temperature



$T_j = 25^\circ C$

Fig 9. Drain-source on-state resistance as a function of drain current; typical values



$$a = \frac{R_{DSon}}{R_{DSon(25^\circ C)}}$$

Fig 10. Normalized drain-source on-state resistance factor as a function of junction temperature

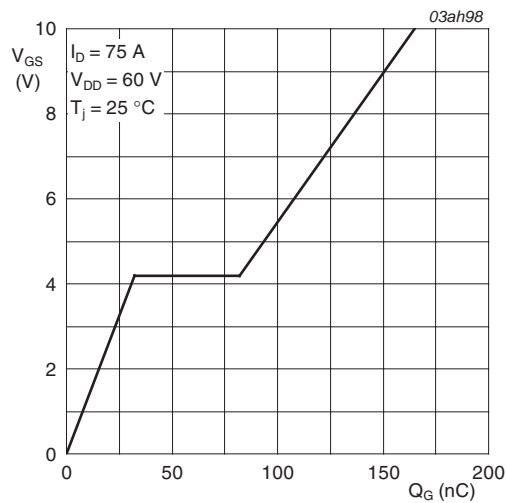

$I_D = 75 A; V_{DD} = 60 V; T_j = 25^\circ C$

Fig 11. Gate-source voltage as a function of gate charge; typical values

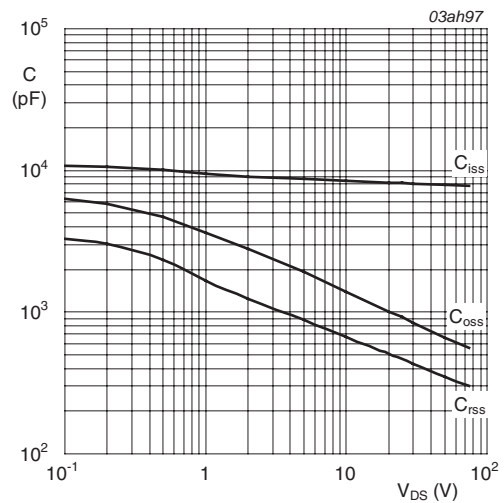

$V_{GS} = 0V; f = 1MHz$

Fig 12. Input, output and reverse transfer capacitances as a function of drain-source voltage; typical values

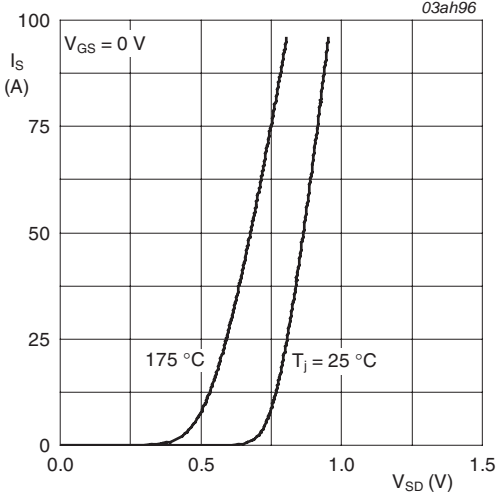

$T_j = 25\text{ °C}$ and 175 °C ; $V_{GS} = 0\text{ V}$

Fig 13. Source current as a function of source-drain voltage; typical values

7. Package outline

Plastic single-ended surface-mounted package (D2PAK); 3 leads (one lead cropped)

SOT404

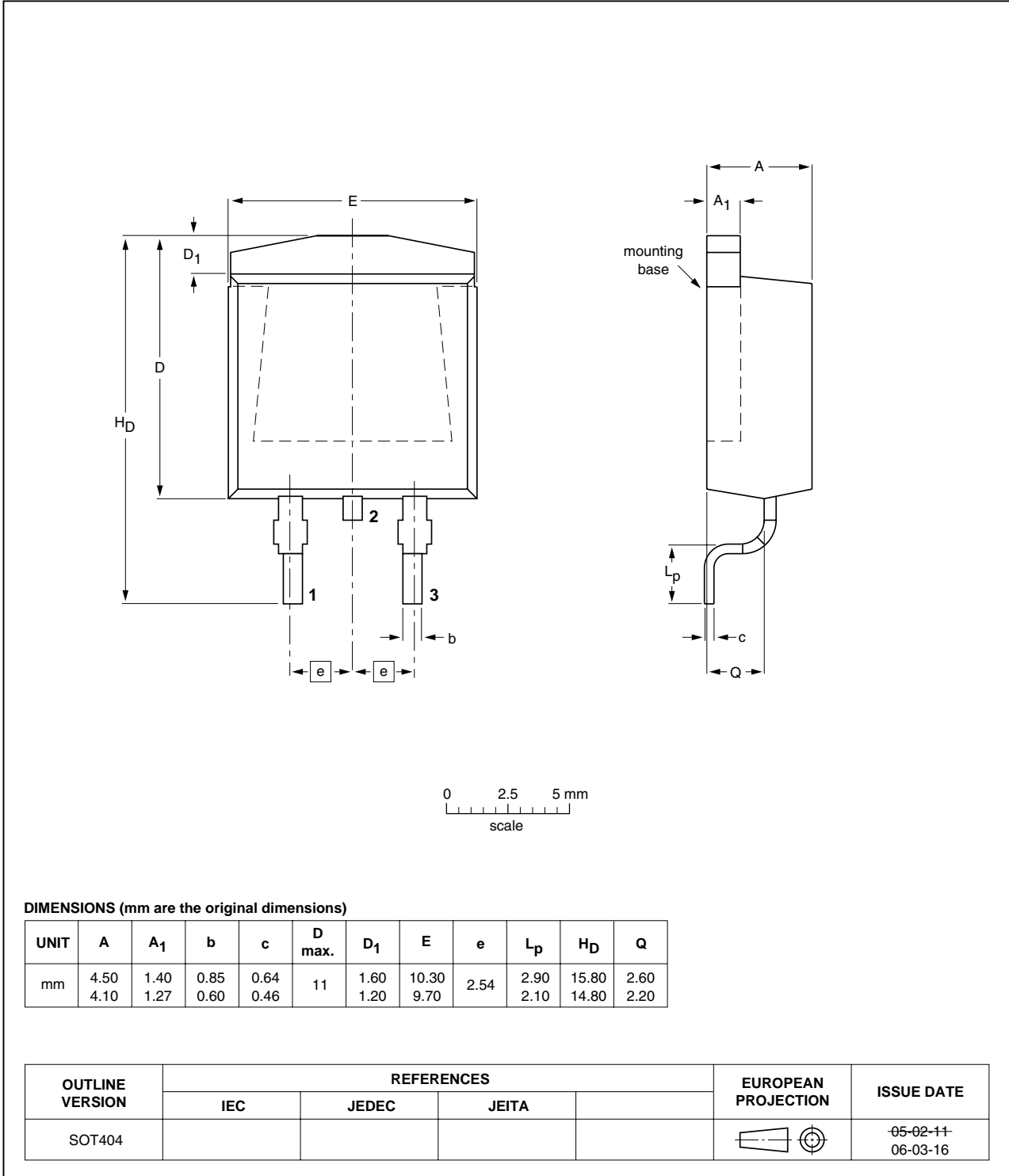

Fig 14. Package outline SOT404 (D2PAK)

8. Revision history

Table 7. Revision history

Document ID	Release date	Data sheet status	Change notice	Supersedes
PSMN005-75B_1	20091116	Product data sheet	-	-

9. Legal information

9.1 Data sheet status

Document status ^{[1][2]}	Product status ^[3]	Definition
Objective [short] data sheet	Development	This document contains data from the objective specification for product development.
Preliminary [short] data sheet	Qualification	This document contains data from the preliminary specification.
Product [short] data sheet	Production	This document contains the product specification.

[1] Please consult the most recently issued document before initiating or completing a design.

[2] The term 'short data sheet' is explained in section "Definitions".

[3] The product status of device(s) described in this document may have changed since this document was published and may differ in case of multiple devices. The latest product status information is available on the Internet at URL <http://www.nexperia.com>.

9.2 Definitions

Draft — The document is a draft version only. The content is still under internal review and subject to formal approval, which may result in modifications or additions. Nexperia does not give any representations or warranties as to the accuracy or completeness of information included herein and shall have no liability for the consequences of use of such information.

Short data sheet — A short data sheet is an extract from a full data sheet with the same product type number(s) and title. A short data sheet is intended for quick reference only and should not be relied upon to contain detailed and full information. For detailed and full information see the relevant full data sheet, which is available on request via the local Nexperia sales office. In case of any inconsistency or conflict with the short data sheet, the full data sheet shall prevail.

9.3 Disclaimers

General — Information in this document is believed to be accurate and reliable. However, Nexperia does not give any representations or warranties, expressed or implied, as to the accuracy or completeness of such information and shall have no liability for the consequences of use of such information.

Right to make changes — Nexperia reserves the right to make changes to information published in this document, including without limitation specifications and product descriptions, at any time and without notice. This document supersedes and replaces all information supplied prior to the publication hereof.

Suitability for use — Nexperia products are not designed, authorized or warranted to be suitable for use in medical, military, aircraft, space or life support equipment, nor in applications where failure or malfunction of a Nexperia product can reasonably be expected to result in personal injury, death or severe property or environmental damage. Nexperia accepts no liability for inclusion and/or use of Nexperia products in such equipment or applications and therefore such inclusion and/or use is at the customer's own risk.

Applications — Applications that are described herein for any of these products are for illustrative purposes only. Nexperia makes no representation or warranty that such applications will be suitable for the specified use without further testing or modification.

Quick reference data — The Quick reference data is an extract of the product data given in the Limiting values and Characteristics sections of this document, and as such is not complete, exhaustive or legally binding.

Limiting values — Stress above one or more limiting values (as defined in the Absolute Maximum Ratings System of IEC 60134) may cause permanent damage to the device. Limiting values are stress ratings only and operation of the device at these or any other conditions above those given in the Characteristics sections of this document is not implied. Exposure to limiting values for extended periods may affect device reliability.

Terms and conditions of sale — Nexperia products are sold subject to the general terms and conditions of commercial sale, as published at <http://www.nexperia.com/profile/terms>, including those pertaining to warranty, intellectual property rights infringement and limitation of liability, unless explicitly otherwise agreed to in writing by Nexperia. In case of any inconsistency or conflict between information in this document and such terms and conditions, the latter will prevail.

No offer to sell or license — Nothing in this document may be interpreted or construed as an offer to sell products that is open for acceptance or the grant, conveyance or implication of any license under any copyrights, patents or other industrial or intellectual property rights.

Export control — This document as well as the item(s) described herein may be subject to export control regulations. Export might require a prior authorization from national authorities.

9.4 Trademarks

Notice: All referenced brands, product names, service names and trademarks are the property of their respective owners.

10. Contact information

For more information, please visit: <http://www.nexperia.com>

For sales office addresses, please send an email to: salesaddresses@nexperia.com

11. Contents

1	Product profile	1
1.1	General description	1
1.2	Features and benefits	1
1.3	Applications	1
1.4	Quick reference data	1
2	Pinning information	2
3	Ordering information	2
4	Limiting values	3
5	Thermal characteristics	5
6	Characteristics	6
7	Package outline	10
8	Revision history	11
9	Legal information	12
9.1	Data sheet status	12
9.2	Definitions	12
9.3	Disclaimers	12
9.4	Trademarks	12
10	Contact information	12