

BODY WITH HANDLE AND COUPLING ELEMENT

Glass-fibre reinforced polyamide based (PA) technopolymer, black colour, matte finish, UV resistant.

BODY WITH LATCH

Acetal resin based (POM) technopolymer, black colour, matte finish, UV resistant.

FEATURES AND APPLICATIONS

CMS integrates both functions of handle and snap lock into a single product.

The door can be opened by pulling the handle towards the outside at the indicated triangular index point.

The coupling element can be applied on a frame (Fig.1) or on a profile (Fig.2).

ASSEMBLY INSTRUCTIONS

1. Drill the door following the supplied template.
2. Fit the body with handle into the drilled door.
3. Assemble the body with latch on the body with handle by the back side of the door up to the stop and fit with self-tapping stainless steel screws (included in the supply).
4. If you have a frame, drill two holes according to the template. For the correct positioning of the coupling element with respect to the latch, the reference notches on the coupling element and on the body with handle must be aligned.
5. Fit the coupling element to the frame or to the profile by means of M5 cylindrical-head screws with hexagon socket (not supplied).

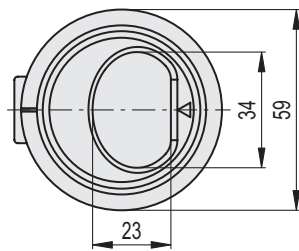
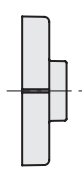
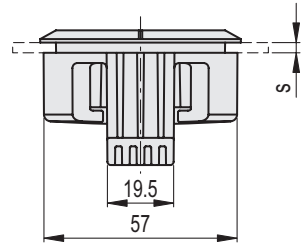
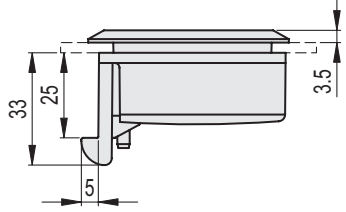
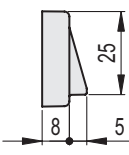
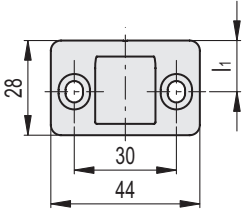
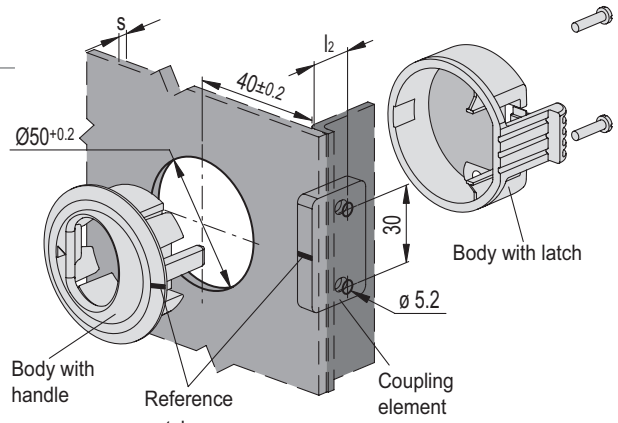
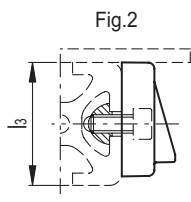
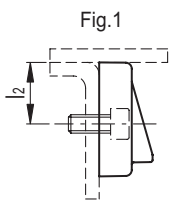
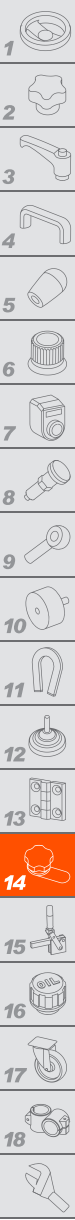

Conversion Table	
1 mm = 0.039 inch	
l1	
mm	inch
15	0.60
20	0.79

METRIC

Code	Description	l1	l2	l3	s	⚖
6271	CMS.60-10-30	15	15	30	1 + 10	55
6276	CMS.60-10-40	20	20	40	1 + 10	55