

18Mb ZBT[®] SRAM

**MT55L1MY18P, MT55V1MV18P,
MT55L512Y32P, MT55V512V32P,
MT55L512Y36P, MT55V512V36P**

3.3V V_{DD}, 3.3V or 2.5V I/O; 2.5V V_{DD}, 2.5V I/O

Features

- High frequency and 100 percent bus utilization
- Single 3.3V ±5 percent or 2.5V ±5 percent power supply
- Separate 3.3V ±5 percent or 2.5V ±5 percent isolated output buffer supply (V_{DDQ})
- Advanced control logic for minimum control signal interface
- Individual byte write controls may be tied LOW
- Single R/W# (read/write) control pin/ball
- CKE# pin/ball to enable clock and suspend operations
- Three chip enables for simple depth expansion
- Clock-controlled and registered addresses, data I/Os, and control signals
- Internally self-timed, fully coherent WRITE
- Internally self-timed, registered outputs to eliminate the need to control OE#
- SNOOZE MODE for reduced-power standby
- Common data inputs and data outputs
- Linear or Interleaved Burst Modes
- Burst feature (optional)
- Pin and ball/function compatibility with 2Mb, 4Mb, and 8Mb ZBT SRAM

Options

- Timing (Access/Cycle/MHz)
 - 3.2ns/5ns/200 MHz
 - 3.5ns/6ns/166 MHz
 - 4.2ns/7.5ns/133 MHz
 - 5ns/10ns/100 MHz
- Configurations
 - 3.3V V_{DD}, 3.3V, or 2.5V I/O
 - 1 Meg x 18
 - 512K x 32
 - 512K x 36
 - 2.5V V_{DD}, 2.5V I/O
 - 1 Meg x 18
 - 512K x 32
 - 512K x 36
- Packages
 - 100-pin TQFP
 - 165-ball, 13mm x 15mm FBGA
- Operating Temperature Range
 - Commercial (0°C ≤ T_A ≤ +70°C)
 - Industrial (-40°C ≤ T_A ≤ +85°C)

TQFP Marking

-5	MT55L1MY18P
-6	MT55L512Y32P
-7.5	MT55L512Y36P
-10	
	MT55V1MV18P
	MT55V512V32P
	MT55V512V36P

NOTE:

1. A Part Marking Guide for the FBGA devices can be found on Micron's Web site—<http://www.micron.com/numberguide>.
2. Contact Factory for availability of Industrial Temperature devices.

Figure 1: 100-Pin TQFP
JEDEC-Standard MS-026 BHA (LQFP)

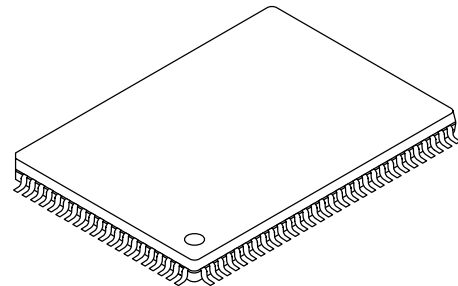
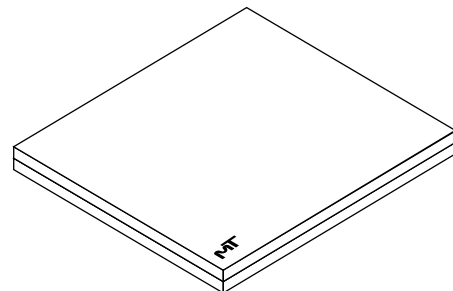

Figure 2: 165-Ball FBGA
JEDEC-Standard MS-216 (Var. CAB-1)



Part Number Example:

MT55L512Y36PT-10

General Description

The Micron[®] Zero Bus Turnaround[™] (ZBT[®]) SRAM family employs high-speed, low-power CMOS designs using an advanced CMOS process.

Micron's 18Mb ZBT SRAMs integrate a 1 Meg x 18, 512K x 32, or 512K x 36 SRAM core with advanced synchronous peripheral circuitry and a 2-bit burst counter. These SRAMs are optimized for 100 percent bus utilization, eliminating any turnaround cycles for READ to WRITE, or WRITE to READ, transitions. All synchronous inputs pass through registers controlled by a positive-edge-triggered single clock input (CLK). The synchronous inputs include all addresses, all data inputs, chip enable (CE#), two additional chip enables

for easy depth expansion (CE2, CE2#), cycle start input (ADV/LD#), synchronous clock enable (CKE#), byte write enables (BWA#, BWb#, BWc# and Bwd#), and read/write (R/W#).

Asynchronous inputs include the output enable (OE#, which may be tied LOW for control signal minimization), clock (CLK) and snooze enable (ZZ, which may be tied LOW if unused). There is also a burst mode pin/ball (MODE) that selects between interleaved and linear burst modes. MODE may be tied HIGH, LOW or left unconnected if burst is unused. The data out (Q) is enabled by OE#. WRITE cycles can be from one to four bytes wide as controlled by the write control inputs.

All READ, WRITE, and DESELECT cycles are initiated by the ADV/LD# input. Subsequent burst addresses can be internally generated as controlled by the burst advance pin/ball (ADV/LD#). Use of burst mode is optional. It is allowable to give an address for each individual READ and WRITE cycle. BURST cycles wrap around after the fourth access from a base address.

To allow for continuous, 100 percent use of the data bus, the pipelined ZBT SRAM uses a late LATE WRITE cycle. For example, if a WRITE cycle begins in clock

cycle one, the address is present on rising edge one. BYTE WRITES need to be asserted on the same cycle as the address. The data associated with the address is required two cycles later, or on the rising edge of clock cycle three.

Address and write control are registered on-chip to simplify WRITE cycles. This allows self-timed write cycles. Individual byte enables allow individual bytes to be written. During a BYTE WRITE cycle, BWA# controls DQa pins/balls; BWb# controls DQb pins/balls; BWc# controls DQc pins/balls; and Bwd# controls DQd pins/balls. Cycle types can only be defined when an address is loaded, i.e., when ADV/LD# is LOW. Parity/ECC bits are only available on the x18 and x36 versions.

The device is ideally suited for systems requiring high bandwidth and zero bus turnaround delays.

Please refer to Micron's Web site (www.micron.com/sramds) for the latest data sheet.

Dual Voltage I/O

The 3.3V VDD device is tested for 3.3V and 2.5V I/O function. The 2.5V VDD device is tested for only 2.5V I/O function.

**Figure 3: Functional Block Diagram
1 Meg x 18**

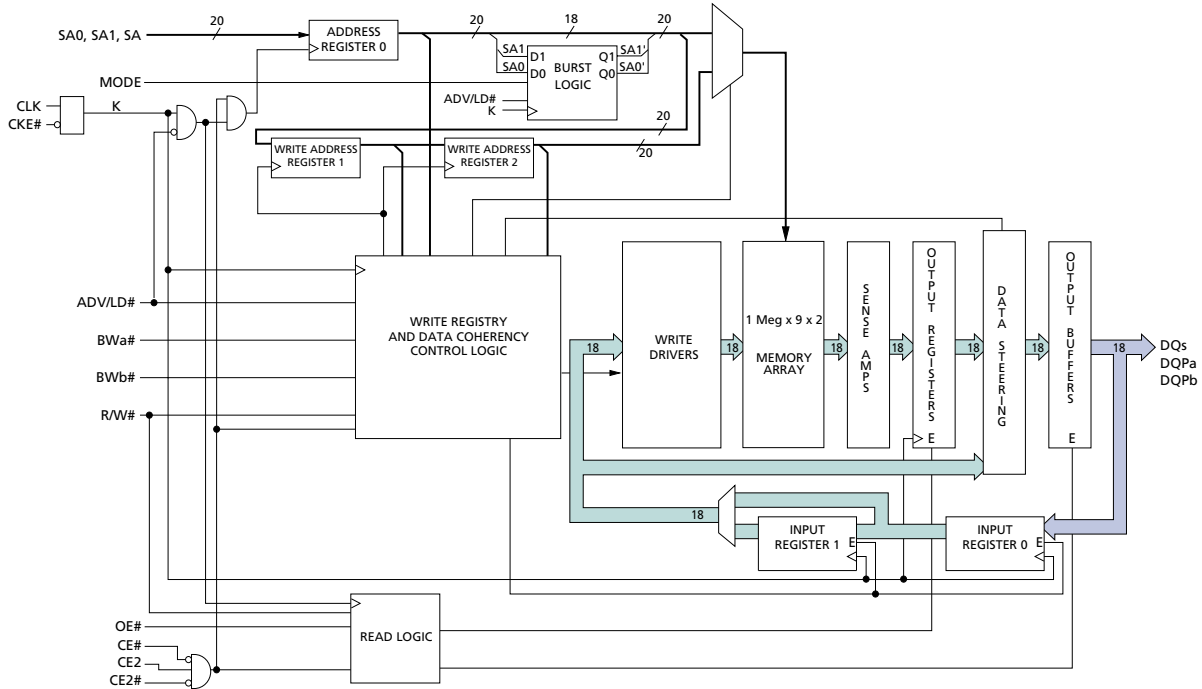

**Figure 4: Functional Block Diagram
512K x 32/36**

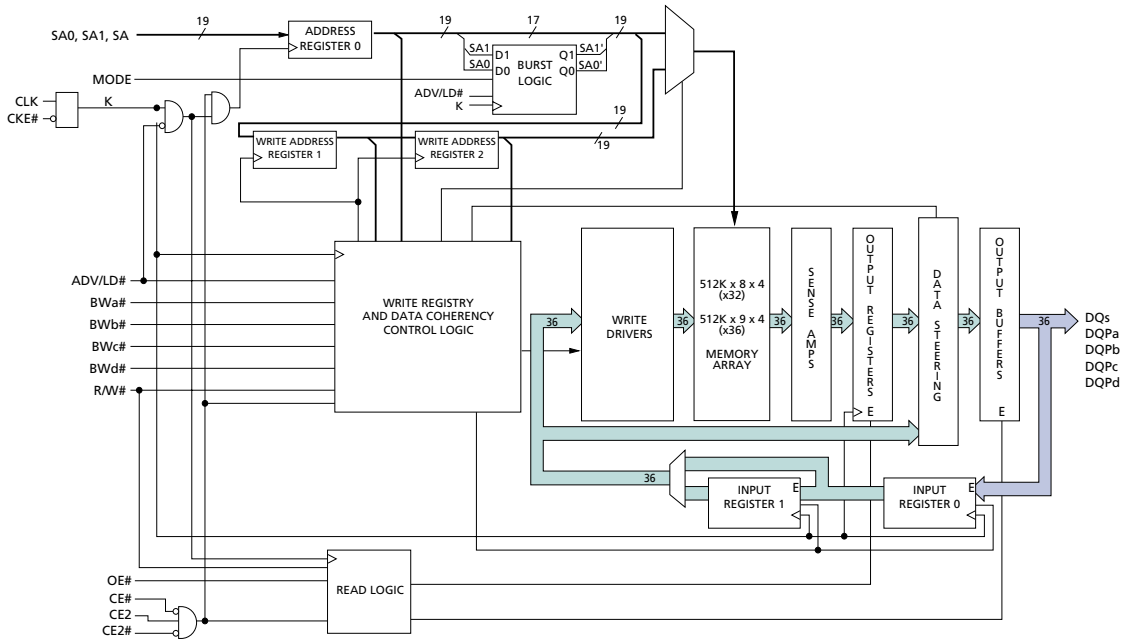

NOTE:

1. Functional block diagrams illustrate simplified device operation. See truth tables, pin/ball descriptions, and timing diagrams for detailed information.

**Figure 5: Pin Layout (Top View)
100-Pin TQFP**

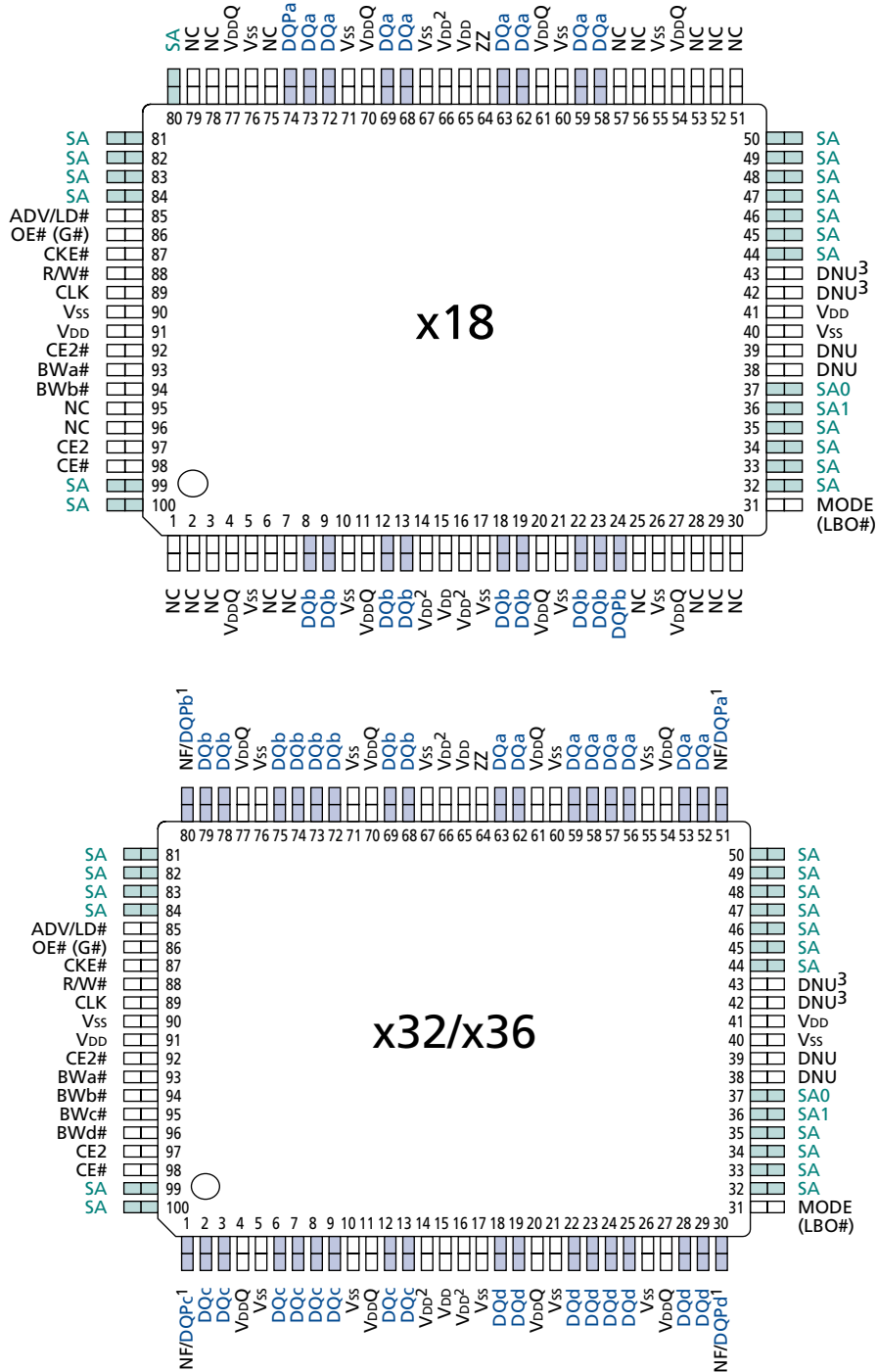

NOTE:

1. No Function (NF) is used on the x32 version. Parity (DQP_x) is used on the x36 version.
2. Pins 14, 16, and 66 do not have to be connected directly to V_{DD} if the input voltage is ≥ V_{IH}.
3. Pins 43 and 42 are reserved for address expansion; 36Mb and 72Mb, respectively.

Table 1: TQFP Pin Descriptions

SYMBOL	TYPE	DESCRIPTION
ADV/LD#	Input	Synchronous Address Advance/Load: When HIGH, this input is used to advance the internal burst counter, controlling burst access after the external address is loaded. When ADV/LD# is HIGH, R/W# is ignored. A LOW on ADV/LD# clocks a new address at the CLK rising edge.
BWa# BWb# BWc# BWd#	Input	Synchronous Byte Write Enables: These active LOW inputs allow individual bytes to be written when a WRITE cycle is active and must meet the setup and hold times around the rising edge of CLK. BWs need to be asserted on the same cycle as the address. BWs are associated with addresses and apply to subsequent data. BWa# controls DQa pins; BWb# controls DQb pins; BWc# controls DQc pins; BWd# controls DQd pins.
CE#	Input	Synchronous Chip Enable: This active LOW input is used to enable the device and is sampled only when a new external address is loaded (ADV/LD# LOW).
CE2#	Input	Synchronous Chip Enable: This active LOW input is used to enable the device and is sampled only when a new external address is loaded (ADV/LD# LOW). This input can be used for memory depth expansion.
CE2	Input	Synchronous Chip Enable: This active HIGH input is used to enable the device and is sampled only when a new external address is loaded (ADV/LD# LOW). This input can be used for memory depth expansion.
CKE#	Input	Synchronous Clock Enable: This active LOW input permits CLK to propagate throughout the device. When CKE# is HIGH, the device ignores the CLK input and effectively internally extends the previous CLK cycle. This input must meet setup and hold times around the rising edge of CLK.
CLK	Input	Clock: This signal registers the address, data, chip enables, byte write enables, and burst control inputs on its rising edge. All synchronous inputs must meet setup and hold times around the clock's rising edge.
MODE (LBO#)	Input	Mode: This input selects the burst sequence. A LOW on this pin selects linear burst. NC or HIGH on this pin selects interleaved burst. Do not alter input state while device is operating. LBO# is the JEDEC-standard term for MODE.
OE# (G#)	Input	Output Enable: This active LOW, asynchronous input enables the data I/O output drivers. G# is the JEDEC-standard term for OE#.
R/W#	Input	Read/Write: This input determines the cycle type when ADV/LD# is LOW and is the only means for determining READs and WRITEs. READ cycles may not be converted into WRITEs (and vice versa) other than by loading a new address. A LOW on this pin permits BYTE WRITE operations and must meet the setup and hold times around the rising edge of CLK. Full bus-width WRITEs occur if all byte write enables are LOW.
SA0 SA1 SA	Input	Synchronous Address Inputs: These inputs are registered and must meet the setup and hold times around the rising edge of CLK. SA0 and SA1 are the two least significant bits (LSB) of the address field and set the internal burst counter if burst is desired.
ZZ	Input	Snooze Enable: This active HIGH, asynchronous input causes the device to enter a low-power standby mode in which all data in the memory array is retained. When ZZ is active, all other inputs are ignored. This pin has an internal pull-down and can be left unconnected.
DQa DQb DQc DQd	Input/ Output	SRAM Data I/Os: Byte "a" associated with is DQa pins; byte "b" is associated with DQb pins; byte "c" is associated with DQc pins; byte "d" is associated with DQd pins. Input data must meet setup and hold times around the rising edge of CLK.
NF/DQP a NF/DQP b NF/DQP c NF/DQP d	NF I/O	No Function/Parity Data I/Os: On the x32 version, these are No Function (NF). On the x18 version, byte "a" parity is DQP a; byte "b" parity is DQP b. On the x36 version, byte "a" parity is DQP a; byte "b" parity is DQP b; byte "c" parity is DQP c; byte "d" parity is DQP d.
VDD	Supply	Power Supply: See DC Electrical Characteristics and Operating Conditions for range.
VDDQ	Supply	Isolated Output Buffer Supply: See DC Electrical Characteristics and Operating Conditions for range.
VSS	Supply	Ground: GND.

Table 1: TQFP Pin Descriptions (continued)

SYMBOL	TYPE	DESCRIPTION
DNU	–	Do Not Use: These pins are internally connected to the die. They may be left floating or connected to ground to improve package heat dissipation.
NC	–	No Connect: These pins are not internally connected to the die. They may be left floating, driven by signals, or connected to ground to improve package heat dissipation.
NF	–	No Function: These pins are internally connected to the die and have the capacitance of an input pin. They may be left floating, driven by signals, or connected to ground to improve package heat dissipation.

**Figure 6: Ball Layout (Top View)
165-Ball FBGA**

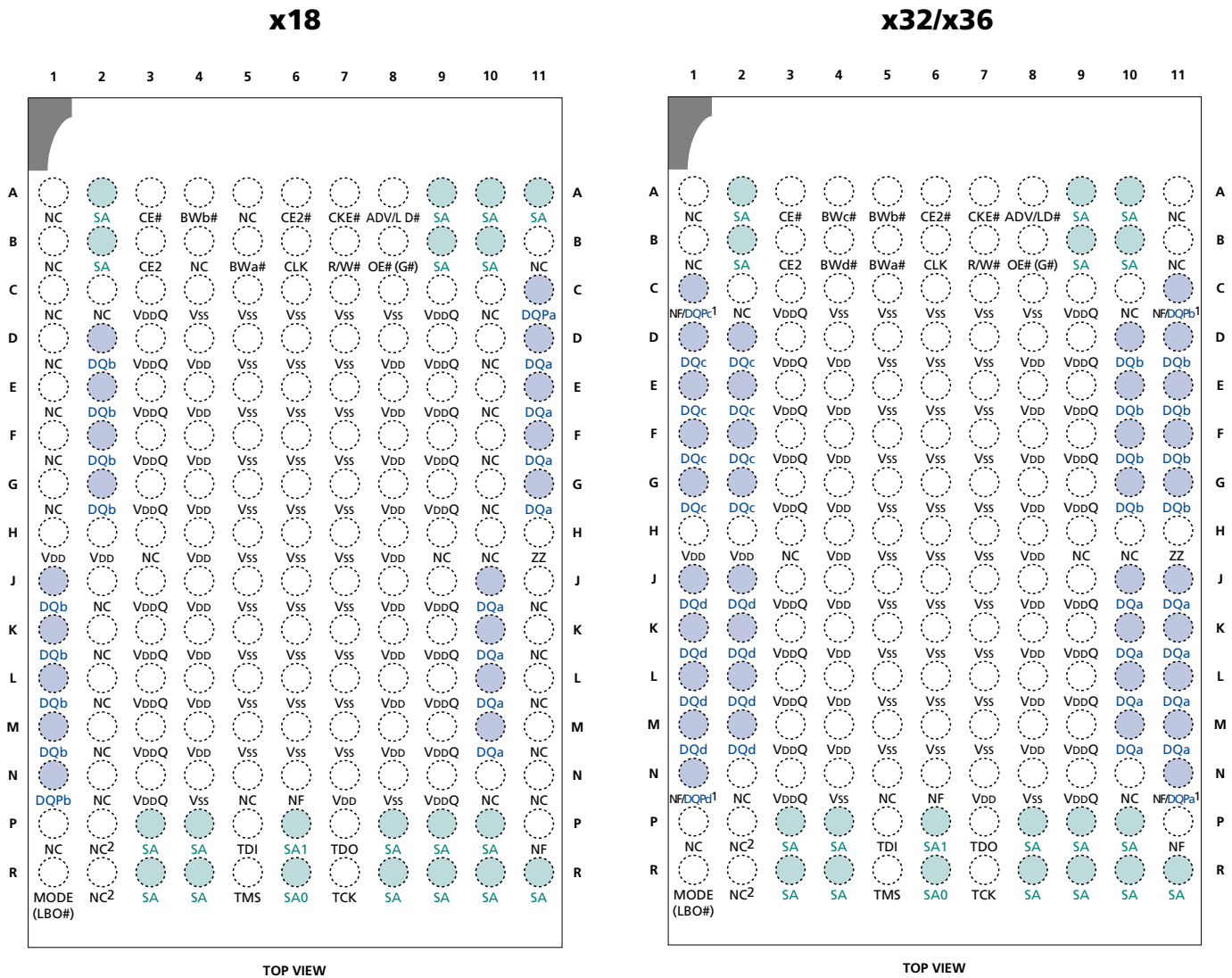

NOTE:

1. No Function (NF) is used on the x32 version. Parity (DQPx) is used on the x36 version.
2. Balls 2R and 2P are reserved for address expansion; 36Mb and 72Mb, respectively.

Table 2: FBGA Ball Descriptions

SYMBOL	TYPE	DESCRIPTION
ADV/LD#	Input	Synchronous Address Advance/Load: When HIGH, this input is used to advance the internal burst counter, controlling burst access after the external address is loaded. When ADV/LD# is HIGH, R/W# is ignored. A LOW on ADV/LD# clocks a new address at the CLK rising edge.
BWa# BWb# BWc# BWd#	Input	Synchronous Byte Write Enables: These active LOW inputs allow individual bytes to be written when a WRITE cycle is active and must meet the setup and hold times around the rising edge of CLK. BWs need to be asserted on the same cycle as the address. BWs are associated with addresses and apply to subsequent data. BWa# controls DQa balls; BWb# controls DQb balls; BWc# controls DQc balls; BWd# controls DQd balls.
CE#	Input	Synchronous Chip Enable: This active LOW input is used to enable the device and is sampled only when a new external address is loaded (ADV/LD# LOW).
CE2#	Input	Synchronous Chip Enable: This active LOW input is used to enable the device and is sampled only when a new external address is loaded (ADV/LD# LOW). This input can be used for memory depth expansion.
CE2	Input	Synchronous Chip Enable: This active HIGH input is used to enable the device and is sampled only when a new external address is loaded (ADV/LD# LOW). This input can be used for memory depth expansion.
CKE#	Input	Synchronous Clock Enable: This active LOW input permits CLK to propagate throughout the device. When CKE# is HIGH, the device ignores the CLK input and effectively internally extends the previous CLK cycle. This input must meet the setup and hold times around the rising edge of CLK.
CLK	Input	Clock: This signal registers the address, data, chip enables, byte write enables, and burst control inputs on its rising edge. All synchronous inputs must meet setup and hold times around the clock's rising edge.
MODE (LBO#)	Input	Mode: This input selects the burst sequence. A LOW on this input selects "linear burst." NC or HIGH on this input selects "interleaved burst." Do not alter input state while device is operating. LBO# is the JEDEC-standard term for MODE.
OE# (G#)	Input	Output Enable: This active LOW, asynchronous input enables the data I/O output drivers. G# is the JEDEC-standard term for OE#.
R/W#	Input	Read/Write: This input determines the cycle type when ADV/LD# is LOW and is the only means for determining READs and WRITEs. READ cycles may not be converted into WRITEs (and vice versa) other than by loading a new address. A LOW on this ball permits BYTE WRITE operations to meet the setup and hold times around the rising edge of CLK. Full bus-width WRITEs occur if all byte write enables are LOW.
SA0 SA1 SA	Input	Synchronous Address Inputs: These inputs are registered and must meet the setup and hold times around the rising edge of CLK. SA0 and SA1 are the two least significant bits (LSB) of the address field and set the internal burst counter if burst is desired.
TMS TDI TCK	Input	IEEE 1149.1 Test Inputs: JEDEC-standard 3.3V and 2.5V I/O levels. These balls may be left not connected if the JTAG function is not used in the circuit.
ZZ	Input	Snooze Enable: This active HIGH, asynchronous input causes the device to enter a low-power standby mode in which all data in the memory array is retained. When ZZ is active, all other inputs are ignored. This ball has an internal pull-down and can be left unconnected.
DQa DQb DQc DQd	Input/ Output	SRAM Data I/Os: For the x18 version, byte "a" is associated with DQa balls; byte "b" is associated with DQb balls. For the x32 and x36 versions, byte "a" is associated with DQa balls; byte "b" is associated with DQb balls; byte "c" is associated with DQc balls; byte "d" is associated with DQd balls. Input data must meet setup and hold times around the rising edge of CLK.

Table 2: FBGA Ball Descriptions (continued)

SYMBOL	TYPE	DESCRIPTION
NF/DQPa NF/DQPb NF/DQPc NF/DQPd	NF I/O	No Function/Parity Data I/Os: On the x32 version, these are No Function (NF). On the x18 version, byte "a" parity is DQPa; byte "b" parity is DQPb. On the x36 version, byte "a" parity is DQPa; byte "b" parity is DQPb; byte "c" parity is DQPc; byte "d" parity is DQPd.
TDO	Output	IEEE 1149.1 Test Output: JEDEC-standard 3.3V and 2.5V I/O levels.
VDD	Supply	Power Supply: See DC Electrical Characteristics and Operating Conditions for range.
VDDQ	Supply	Isolated Output Buffer Supply: See DC Electrical Characteristics and Operating Conditions for range.
Vss	Supply	Ground: GND.
NC	–	No Connect: These balls are not internally connected to the die. They may be left floating, driven by signals, or connected to ground to improve package heat dissipation.
NF	–	No Function: These balls are internally connected to the die and have the capacitance of an input ball. They may be left floating, driven by signals, or connected to ground to improve package heat dissipation.

Table 3: Interleaved Burst Address Table (Mode = NC or HIGH)

FIRST ADDRESS (EXTERNAL)	SECOND ADDRESS (INTERNAL)	THIRD ADDRESS (INTERNAL)	FOURTH ADDRESS (INTERNAL)
X...X00	X...X01	X...X10	X...X11
X...X01	X...X00	X...X11	X...X10
X...X10	X...X11	X...X00	X...X01
X...X11	X...X10	X...X01	X...X00

Table 4: Linear Burst Address Table (Mode = LOW)

FIRST ADDRESS (EXTERNAL)	SECOND ADDRESS (INTERNAL)	THIRD ADDRESS (INTERNAL)	FOURTH ADDRESS (INTERNAL)
X...X00	X...X01	X...X10	X...X11
X...X01	X...X10	X...X11	X...X00
X...X10	X...X11	X...X00	X...X01
X...X11	X...X00	X...X01	X...X10

Table 5: Partial Truth Table For READ/WRITE Commands (x18)

FUNCTION	R/W#	BWa#	BWb#
READ	H	X	X
WRITE Byte "a"	L	L	H
WRITE Byte "b"	L	H	L
WRITE All Byte	L	L	L
WRITE ABORT/NOP	L	H	H

NOTE:

Using R/W# and byte write(s), any one or more bytes may be written.

Table 6: Partial Truth Table For READ/WRITE Commands (x32/x36)

FUNCTION	R/W#	BWa#	BWb#	BWc#	BWd#
READ	H	X	X	X	X
WRITE Byte "a"	L	L	H	H	H
WRITE Byte "b"	L	H	L	H	H
WRITE Byte "c"	L	H	H	L	H
WRITE Byte "d"	L	H	H	H	L
WRITE All Byte	L	L	L	L	L
WRITE ABORT/NOP	L	H	H	H	H

NOTE:

Using R/W# and byte write(s), any one or more bytes may be written.

**Figure 7:
State Diagram For ZBT SRAM**

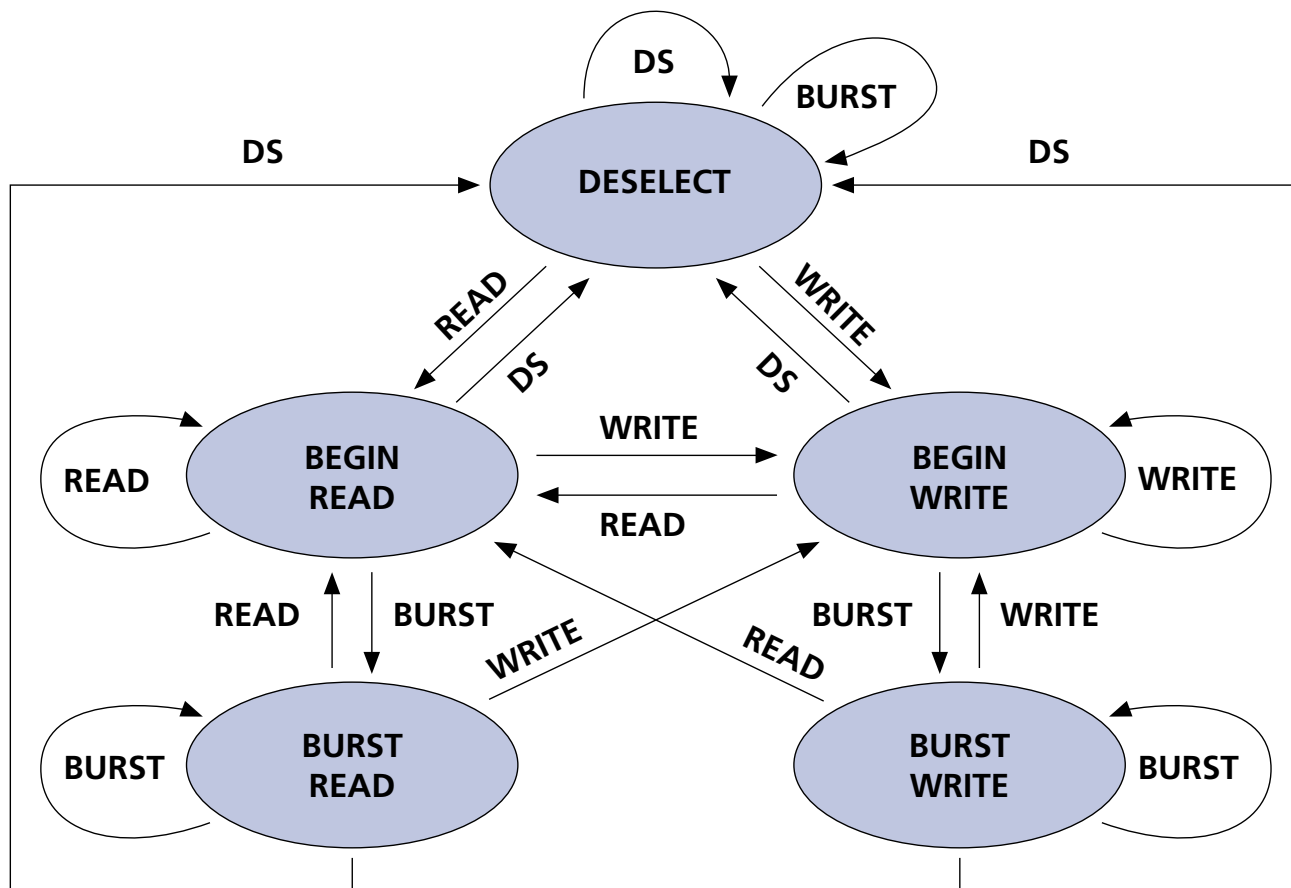

KEY:

COMMAND	OPERATION
DS	DESELECT
READ	New READ
WRITE	New WRITE
BURST	BURST READ, BURST WRITE, or CONTINUE DESELECT

NOTE:

1. A STALL or IGNORE CLOCK EDGE cycle is not shown in the above diagram. This is because CKE# HIGH only blocks the clock (CLK) input and does not change the state of the device.
2. States change on the rising edge of the clock (CLK).

Table 7: Truth Table

Notes: 5–10

OPERATION	ADDRESS USED	CE#	CE2#	CE2	ZZ	ADV/LD#	R/W#	BWx	OE#	CKE#	CLK	DQ	NOTES
DESELECT CYCLE	None	H	X	X	L	L	X	X	X	L	L→H	High-Z	
DESELECT Cycle	None	X	H	X	L	L	X	X	X	L	L→H	High-Z	
DESELECT Cycle	None	X	X	L	L	L	X	X	X	L	L→H	High-Z	
CONTINUE DESELECT Cycle	None	X	X	X	L	H	X	X	X	L	L→H	High-Z	1
READ Cycle (Begin Burst)	External	L	L	H	L	L	H	X	L	L	L→H	Q	
READ Cycle (Continue Burst)	Next	X	X	X	L	H	X	X	L	L	L→H	Q	1, 11
NOP/DUMMY READ (Begin Burst)	External	L	L	H	L	L	H	X	H	L	L→H	High-Z	2
DUMMY READ (Continue Burst)	Next	X	X	X	L	H	X	X	H	L	L→H	High-Z	1, 2, 11
WRITE Cycle (Begin Burst)	External	L	L	H	L	L	L	L	X	L	L→H	D	3
WRITE Cycle (Continue Burst)	Next	X	X	X	L	H	X	L	X	L	L→H	D	1, 3, 11
NOP/WRITE ABORT (Begin Burst)	None	L	L	H	L	L	L	H	X	L	L→H	High-Z	2, 3
WRITE ABORT (Continue Burst)	Next	X	X	X	L	H	X	H	X	L	L→H	High-Z	1, 2, 3, 11
IGNORE CLOCK EDGE (Stall)	Current	X	X	X	L	X	X	X	X	H	L→H	–	4
SNOOZE MODE	None	X	X	X	H	X	X	X	X	X	X	High-Z	

NOTE:

1. CONTINUE BURST cycles, whether READ or WRITE, use the same control inputs. The type of cycle performed (READ or WRITE) is chosen in the initial BEGIN BURST cycle. A CONTINUE DESELECT cycle can only be entered if a DESELECT cycle is executed first.
2. DUMMY READ and WRITE ABORT cycles can be considered NOPs because the device performs no external operation. A WRITE ABORT means a WRITE command is given, but no operation is performed.
3. OE# may be wired LOW to minimize the number of control signals to the SRAM. The device will automatically turn off the output drivers during a WRITE cycle. OE# may be used when the bus turn-on and turn-off times do not meet an application's requirements.
4. If an IGNORE CLOCK EDGE command occurs during a READ operation, the DQ bus will remain active (Low-Z). If it occurs during a WRITE cycle, the bus will remain in High-Z. No WRITE operations will be performed during the IGNORE CLOCK EDGE cycle.
5. X means "Don't Care." H means logic HIGH. L means logic LOW. BWx = H means all byte write signals (BWA#, BWB#, BWc#, and BWD#) are HIGH. BWx = L means one or more byte write signals are LOW.
6. BWA# enables WRITES to byte "a" (DQa pins/balls); BWB# enables WRITES to byte "b" (DQb pins/balls); BWc# enables WRITES to byte "c" (DQc pins/balls); BWD# enables WRITES to byte "d" (DQd pins/balls).
7. All inputs except OE# and ZZ must meet setup and hold times around the rising edge (LOW to HIGH) of CLK.
8. Wait states are inserted by setting CKE# HIGH.
9. This device contains circuitry that will ensure that the outputs will be in High-Z during power-up.
10. The device incorporates a 2-bit burst counter. Address wraps to the initial address every fourth BURST CYCLE.
11. The address counter is incremented for all CONTINUE BURST cycles.

Absolute Maximum Ratings

3.3V VDD

Voltage on VDD Supply	
Relative to VSS	-0.5V to +4.6V
Voltage on VDDQ Supply	
Relative to VSS	-0.5V to VDD
V _{IN} (Inputs)	-0.5V to VDD + 0.5V
V _{IN} (DQs)	-0.5V to VDDQ + 0.5V
Storage Temperature (TQFP).....	-55°C to +150°C
Storage Temperature (FBGA).....	-55°C to +125°C
Junction Temperature	+150°C
Short Circuit Output Current	100mA

2.5V VDD

Voltage on VDD Supply	
Relative to VSS	-0.3V to +3.6V
Voltage on VDDQ Supply Relative	
to VSS	-0.3V to +3.6V
V _{IN} (Inputs)	-0.3V to VDD + 0.3V
V _{IN} (DQs)	-0.3V to VDDQ + 0.3V
Storage Temperature (TQFP).....	-55°C to +150°C
Storage Temperature (FBGA).....	-55°C to +125°C
Junction Temperature	+150°C
Short Circuit Output Current	100mA

Stresses greater than those listed may cause permanent damage to the device. This is a stress rating only, and functional operation of the device at these or any other conditions above those indicated in the operational sections of this specification is not implied. Exposure to absolute maximum rating conditions for extended periods may affect reliability.

Junction temperature depends upon package type, cycle time, loading, ambient temperature, and airflow.

Table 8: 3.3V VDD, 3.3V I/O DC Electrical Characteristics and Operating Conditions

Notes appear following parameter tables on page 18; 0°C ≤ T_A ≤ +70°C; VDD and VDDQ = 3.3V ±0.165V unless otherwise noted

DESCRIPTION	CONDITIONS	SYMBOL	MIN	MAX	UNITS	NOTES
Input High (Logic 1) Voltage		V _{IH}	2.0	VDD + 0.3	V	1, 2
Input Low (Logic 0) Voltage		V _{IL}	-0.3	0.8	V	1, 2
Input Leakage Current	0V ≤ V _{IN} ≤ VDD	I _{LI}	-1.0	1.0	μA	4
Output Leakage Current	Output(s) disabled, 0V ≤ V _{IN} ≤ VDD	I _{LO}	-1.0	1.0	μA	
Output High Voltage	I _{OH} = -4.0mA	V _{OH}	2.4		V	1
Output Low Voltage	I _{OL} = 8.0mA	V _{OL}		0.4	V	1
Supply Voltage		VDD	3.135	3.465	V	1
Isolated Output Buffer Supply		VDDQ	3.135	VDD	V	1, 5

Table 9: 3.3V V_{DD}, 2.5V I/O DC Electrical Characteristics and Operating Conditions

Notes appear following parameter tables on page 18; 0°C ≤ T_A ≤ +70°C; V_{DD} = 3.3V ±0.165V and V_{DDQ} = 2.5V ±0.125V unless otherwise noted

DESCRIPTION	CONDITIONS	SYMBOL	MIN	MAX	UNITS	NOTES
Input High (Logic 1) Voltage	Data bus (DQx)	V _{IHQ}	1.7	V _{DDQ} + 0.3	V	1, 2
	Inputs	V _{IH}	1.7	V _{DD} + 0.3	V	1, 2
Input Low (Logic 0) Voltage		V _{IL}	-0.3	0.7	V	1, 2
Input Leakage Current	0V ≤ V _{IN} ≤ V _{DD}	I _{LI}	-1.0	1.0	μA	4
Output Leakage Current	Output(s) disabled, 0V ≤ V _{IN} ≤ V _{DDQ} (DQx)	I _{LO}	-1.0	1.0	μA	
Output High Voltage	I _{OH} = -2.0mA	V _{OH}	1.7	–	V	1
	I _{OH} = -1.0mA	V _{OH}	2.0	–	V	1
Output Low Voltage	I _{OL} = 2.0mA	V _{OL}	–	0.7	V	1
	I _{OL} = 1.0mA	V _{OL}	–	0.4	V	1
Supply Voltage		V _{DD}	3.135	3.465	V	1
Isolated Output Buffer Supply		V _{DDQ}	2.375	2.625	V	1, 5

Table 10: 2.5V V_{DD}, 2.5V I/O DC Electrical Characteristics and Operating Conditions

Notes appear following parameter tables on page 18; 0°C ≤ T_A ≤ +70°C; V_{DD} and V_{DDQ} = 2.5V ±0.125V unless otherwise noted

DESCRIPTION	CONDITIONS	SYMBOL	MIN	MAX	UNITS	NOTES
Input High (Logic 1) Voltage	Data bus (DQx)	V _{IHQ}	1.7	V _{DDQ} + 0.3	V	1, 3
	Inputs	V _{IH}	1.7	V _{DD} + 0.3	V	1, 3
Input Low (Logic 0) Voltage		V _{IL}	-0.3	0.7	V	1, 3
Input Leakage Current	0V ≤ V _{IN} ≤ V _{DD}	I _{LI}	-1.0	1.0	μA	4
Output Leakage Current	Output(s) disabled, 0V ≤ V _{IN} ≤ V _{DDQ} (DQx)	I _{LO}	-1.0	1.0	μA	
Output High Voltage	I _{OH} = -2.0mA	V _{OH}	1.7	–	V	1
	I _{OH} = -1.0mA	V _{OH}	2.0	–	V	1
Output Low Voltage	I _{OL} = 2.0mA	V _{OL}	–	0.7	V	1
	I _{OL} = 1.0mA	V _{OL}	–	0.4	V	1
Supply Voltage		V _{DD}	2.375	2.625	V	1
Isolated Output Buffer Supply		V _{DDQ}	2.375	2.625	V	1, 5

Table 11: TQFP Capacitance

Note 10; notes appear following parameter tables on page 18

DESCRIPTION	CONDITIONS	SYMBOL	TYP	MAX	UNITS
Control Input Capacitance	$T_A = 25^\circ\text{C}; f = 1 \text{ MHz}$ $V_{DD} = 3.3\text{V}$	CI	4.2	5	pF
Input/Output Capacitance (DQ)		CO	3.5	4	pF
Address Input Capacitance		CA	4	5	pF
Clock Capacitance		CCK	4.2	5	pF

Table 12: FBGA Capacitance

Note 10; notes appear following parameter tables on page 18

DESCRIPTION	CONDITIONS	SYMBOL	TYP	MAX	UNITS
Control Input Capacitance	$T_A = 25^\circ\text{C}; f = 1 \text{ MHz}$ $V_{DD} = 3.3\text{V}$	CI	4	5	pF
Input/Output Capacitance (DQ)		CO	4	4.5	pF
Address Input Capacitance		CA	4	5	pF
Clock Capacitance		CCK	5	5.5	pF

Table 13: TQFP Thermal Resistance

Note 10; notes appear following parameter tables on page 18

DESCRIPTION	CONDITIONS	SYMBOL	TYP	UNITS
Junction to Ambient (Airflow of 1m/s, two-layer board)	Test conditions follow standard test methods and procedures for measuring thermal impedance, per EIA/JESD51.	θ_{JA}	28.9	$^\circ\text{C/W}$
Thermal Resistance Junction to Case (Top)		θ_{JC}	4.2	$^\circ\text{C/W}$

Table 14: FBGA Thermal Resistance

Note 10; notes appear following parameter tables on page 18

DESCRIPTION	CONDITIONS	SYMBOL	TYP	UNITS
Junction to Ambient (Airflow of 1m/s, two-layer board)	Test conditions follow standard test methods and procedures for measuring thermal impedance, per EIA/JESD51.	θ_{JA}	32	$^\circ\text{C/W}$
Junction to Case (Top)		θ_{JC}	1.7	$^\circ\text{C/W}$
Junction to Board (Bottom)		θ_{JB}	10.4	$^\circ\text{C/W}$

**Table 15: 3.3V V_{DD}, I_{DD} Operating Conditions and Maximum Limits
(1 Meg x 18 and 512K x 32/36)**

Notes appear following parameter tables on page 18; 0°C ≤ T_A ≤ +70°C; V_{DD} and V_{DDQ} = 3.3V ±0.165V or 2.5V ±0.125V unless otherwise noted

DESCRIPTION	CONDITIONS	SYM	TYP	MAX				UNITS	NOTES
				-5	-6	-7.5	-10		
Power Supply Current: Operating	Device selected; All inputs ≤ V _{IL} or ≥ V _{IH} ; Cycle time ≥ ^t KC (MIN); V _{DD} = MAX; Outputs open	I _{DD}	300	420	380	340	300	mA	6, 7, 8
Power Supply Current: Idle	Device selected; V _{DD} = MAX; CKE# ≥ V _{IH} ; All inputs ≤ V _{SS} + 0.2 or ≥ V _{DD} - 0.2; Cycle time ≥ ^t KC (MIN)	I _{DD1}	120	180	170	160	150	mA	6, 7, 8
CMOS Standby	Device deselected; V _{DD} = MAX; All inputs ≤ V _{SS} + 0.2 or ≥ V _{DD} - 0.2; All inputs static; CLK frequency = 0	I _{SB2}	8	30	30	30	30	mA	7, 8
Clock Running	Device deselected; V _{DD} = MAX; ADV/LD# ≥ V _{IH} ; All inputs ≤ V _{SS} + 0.2 or ≥ V _{DD} - 0.2; Cycle time ≥ ^t KC (MIN)	I _{SB4}	120	180	170	160	150	mA	7, 8
Snooze Mode	ZZ ≥ V _{IH}	I _{SB2Z}	8	30	30	30	30	mA	8

**Table 16: 2.5V V_{DD}, I_{DD} Operating Conditions and Maximum Limits
(1 Meg x 18 and 512K x 32/36)**

Notes appear following parameter tables on page 18; 0°C ≤ T_A ≤ +70°C; V_{DD} and V_{DDQ} = 2.5V ±0.125V unless otherwise noted

DESCRIPTION	CONDITIONS	SYM	TYP	MAX				UNITS	NOTES
				-5	-6	-7.5	-10		
Power Supply Current: Operating	Device selected; All inputs ≤ V _{IL} or ≥ V _{IH} ; Cycle time ≥ ^t KC (MIN); V _{DD} = MAX; Outputs open	I _{DD}	250	370	330	290	250	mA	6, 7, 9
Power Supply Current: Idle	Device selected; V _{DD} = MAX; CKE# ≥ V _{IH} ; All inputs ≤ V _{SS} + 0.2 or ≥ V _{DD} - 0.2; Cycle time ≥ ^t KC (MIN)	I _{DD1}	100	170	150	130	120	mA	6, 7, 9
CMOS Standby	Device deselected; V _{DD} = MAX; All inputs ≤ V _{SS} + 0.2 or ≥ V _{DD} - 0.2; All inputs static; CLK frequency = 0	I _{SB2}	8	30	30	30	30	mA	7, 9
Clock Running	Device deselected; V _{DD} = MAX; ADV/LD# ≥ V _{IH} ; All inputs ≤ V _{SS} + 0.2 or ≥ V _{DD} - 0.2; Cycle time ≥ ^t KC (MIN)	I _{SB4}	100	170	150	130	120	mA	7, 9
Snooze Mode	ZZ ≥ V _{IH}	I _{SB2Z}	8	30	30	30	30	mA	9

Table 17: AC Electrical Characteristics and Recommended Operating Conditions

Notes 11-13 ; notes appear following parameter tables on page 18; $0^{\circ}\text{C} \leq T_A \leq +70^{\circ}\text{C}$; $T_J \leq 95^{\circ}\text{C}$ (commercial); $T_J \leq 110^{\circ}\text{C}$ (industrial); $V_{DD} = 3.3\text{V} \pm 0.165\text{V}$ unless otherwise noted

DESCRIPTION	SYMBOL	-5		-6		-7.5		-10		UNITS	NOTES
		MIN	MAX	MIN	MAX	MIN	MAX	MIN	MAX		
Clock											
Clock cycle time	t_{KHKH}	5.0		6.0		7.5		10.0		ns	
Clock frequency	f_{KF}		200		166		133		100	MHz	
Clock HIGH time	t_{KHKL}	2.0		2.2		3.0		3.2		ns	14
Clock LOW time	t_{KLKH}	2.0		2.2		3.0		3.2		ns	14
Output Times											
Clock to output valid	t_{KHQV}		3.2		3.5		4.2		5.0	ns	
Clock to output invalid	t_{KHQX}	1.0		1.5		1.5		1.5		ns	15
Clock to output in Low-Z	t_{KHQX1}	1.0		1.5		1.5		1.5		ns	10, 15, 16
Clock to output in High-Z	t_{KHQZ}		3.0		3.5		3.5		3.5	ns	10, 15, 16
OE# to output valid	t_{GLQV}		3.0		3.5		4.2		5.0	ns	11
OE# to output in Low-Z	t_{GLQX}	0		0		0		0		ns	10, 15, 16
OE# to output in High-Z	t_{GHQZ}		3.2		3.5		3.5		5.0	ns	10, 15, 16
Setup Times											
Address	t_{AVKH}	1.4		1.5		1.5		2.0		ns	17
Clock enable (CKE#)	t_{EVKH}	1.4		1.5		1.5		2.0		ns	17
Control signals	t_{CVKH}	1.4		1.5		1.5		2.0		ns	17
Data-in	t_{DVKH}	1.4		1.5		1.5		2.0		ns	17
Hold Times											
Address	t_{KHAX}	0.4		0.5		0.5		0.5		ns	17
Clock enable (CKE#)	t_{KHEX}	0.4		0.5		0.5		0.5		ns	17
Control signals	t_{KHGX}	0.4		0.5		0.5		0.5		ns	17
Data-in	t_{KHDX}	0.4		0.5		0.5		0.5		ns	17

Notes

1. All voltages referenced to VSS (GND).
2. For 3.3V VDD:
 - Overshoot: $V_{IH} \leq +4.6V$ for $t \leq t_{KHKH}/2$ for $I \leq 20mA$
 - Undershoot: $V_{IL} \geq -0.7V$ for $t \leq t_{KHKH}/2$ for $I \leq 20mA$
 - Power-up: $V_{IH} \leq +3.6V$ and $V_{DD} \leq 3.135V$ for $t \leq 200ms$
3. For 2.5V VDD:
 - Overshoot: $V_{IH} \leq +3.6V$ for $t \leq t_{KHKH}/2$ for $I \leq 20mA$
 - Undershoot: $V_{IL} \geq -0.5V$ for $t \leq t_{KHKH}/2$ for $I \leq 20mA$
 - Power-up: $V_{IH} \leq +2.65V$ and $V_{DD} \leq 2.375V$ for $t \leq 200ms$
4. The MODE and ZZ pins/balls have an internal pull-up/pull-down and input leakage = $\pm 10\mu A$.
5. VDDQ should never exceed VDD. VDD and VDDQ can be externally wired together to the same power supply.
6. IDD is specified with no output current and increases with faster cycle times. IDDQ increases with faster cycle times and greater output loading.
7. "Device deselected" means device is in power-down mode as defined in the truth table. "Device selected" means device is active (not in power-down mode).
8. Typical values are measured at 3.3V, 25°C, and 10ns cycle time.
9. Typical values are measured at 2.5V, 25°C, and 10ns cycle time.
10. This parameter is sampled.
11. OE# can be considered a "Don't Care" during WRITES; however, controlling OE# can help fine-tune a system for turnaround timing.
12. Test conditions as specified with the output loading shown in Figures 11 and 12 for 3.3V I/O and Figures 13 and 14 for 2.5V I/O unless otherwise noted.
13. A WRITE cycle is defined by R/W# LOW, having been registered into the device at ADV/LD# LOW. A READ cycle is defined by R/W# HIGH with ADV/LD# LOW. Both cases must meet setup and hold times.
14. Measured as HIGH above V_{IH} and LOW below V_{IL} .
15. Refer to Technical Note TN-55-01, "Designing with ZBT SRAMs," for a more thorough discussion of these parameters.
16. This parameter is measure with the output loading shown in Figure 12 for 3.3V I/O and Figure 14 for 2.5V I/O.
17. This is a synchronous device. All addresses must meet the specified setup and hold times with stable logic levels for all rising edges of CLK when the chip is enabled. To remain enabled, chip enable must be valid at each rising edge of CLK when ADV/LD# is LOW.

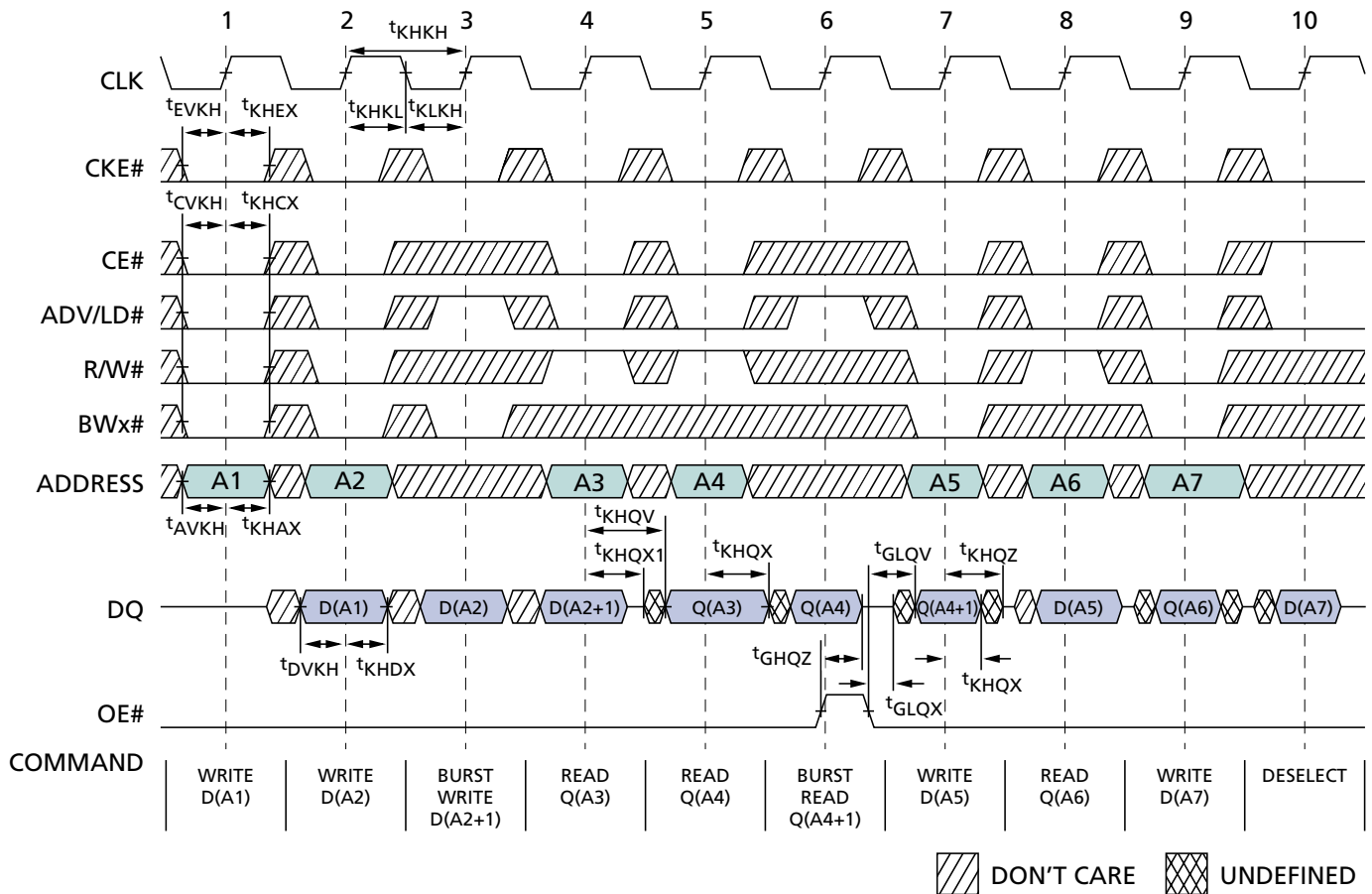
**Figure 8:
READ/WRITE Timing**

NOTE:

1. For these waveforms, ZZ is tied LOW.
2. Burst sequence order is determined by MODE (0 = linear, 1 = interleaved). BURST operations are optional.
3. CE# represents three signals. When CE# = 0, it represents CE# = 0, CE2# = 0, CE2 = 1.
4. Data coherency is provided for all possible operations. If a READ is initiated, the most current data is used. The most recent data may be from the input data register.

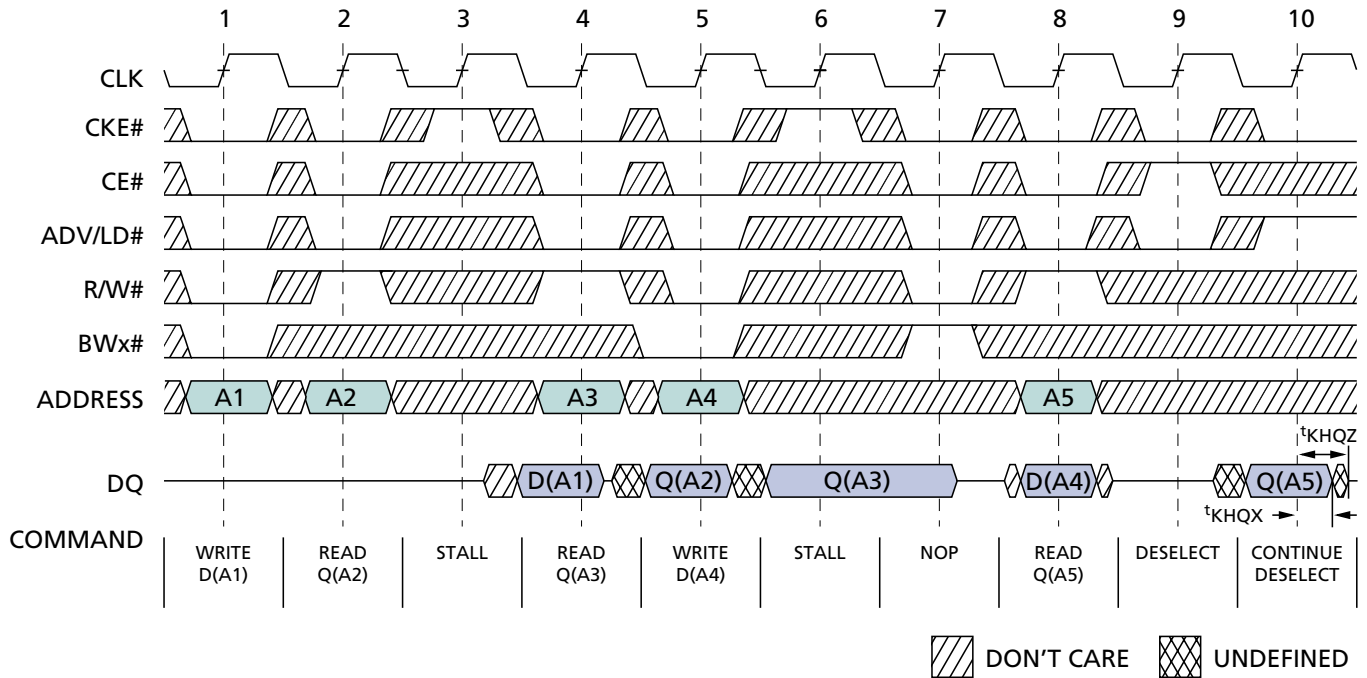
**Figure 9:
NOP, STALL, and DESELECT Cycles**



NOTE:

1. The IGNORE CLOCK EDGE or STALL cycle (clock 3) illustrates CKE# being used to create a "pause." A WRITE is not performed during this cycle.
2. For these waveforms, ZZ and OE# are tied LOW.
3. CE# represents three signals. When CE# = 0, it represents CE# = 0, CE2# = 0, CE2 = 1.
4. Data coherency is provided for all possible operations. If a READ is initiated, the most current data is used. The most recent data may be from the input data register.

SNOOZE MODE

SNOOZE MODE is a low-current, “power-down” mode in which the device is deselected and current is reduced to I_{SB2Z} . The duration of SNOOZE MODE is dictated by the length of time the ZZ is in a HIGH state. After the device enters SNOOZE MODE, all inputs except ZZ become disabled and all outputs go to High-Z.

The ZZ is an asynchronous, active HIGH input that causes the device to enter SNOOZE MODE. When the ZZ becomes a logic HIGH, I_{SB2Z} is guaranteed after the time t_{ZZI} is met. Any READ or WRITE operation pending when the device enters SNOOZE MODE is not guaranteed to complete successfully. Therefore, SNOOZE MODE must not be initiated until valid pending operations are completed. Similarly, when exiting SNOOZE MODE during t_{RZZ} , only a DESELECT or READ cycle should be given.

Table 18: SNOOZE MODE Electrical Characteristics

DESCRIPTION	CONDITIONS	SYMBOL	MIN	MAX	UNITS	NOTES
Current during SNOOZE MODE	$ZZ \geq V_{IH}$	I_{SB2Z}		30	mA	
ZZ active to input ignored		t_{ZZ}		$2(t_{KHKH})$	ns	1
ZZ inactive to input sampled		t_{RZZ}	$2(t_{KHKH})$		ns	1
ZZ active to snooze current		t_{ZZI}		$2(t_{KHKH})$	ns	1
ZZ inactive to exit snooze current		t_{RZZI}	0		ns	1

NOTE:

1. This parameter is sampled.

Figure 10: SNOOZE MODE Waveform

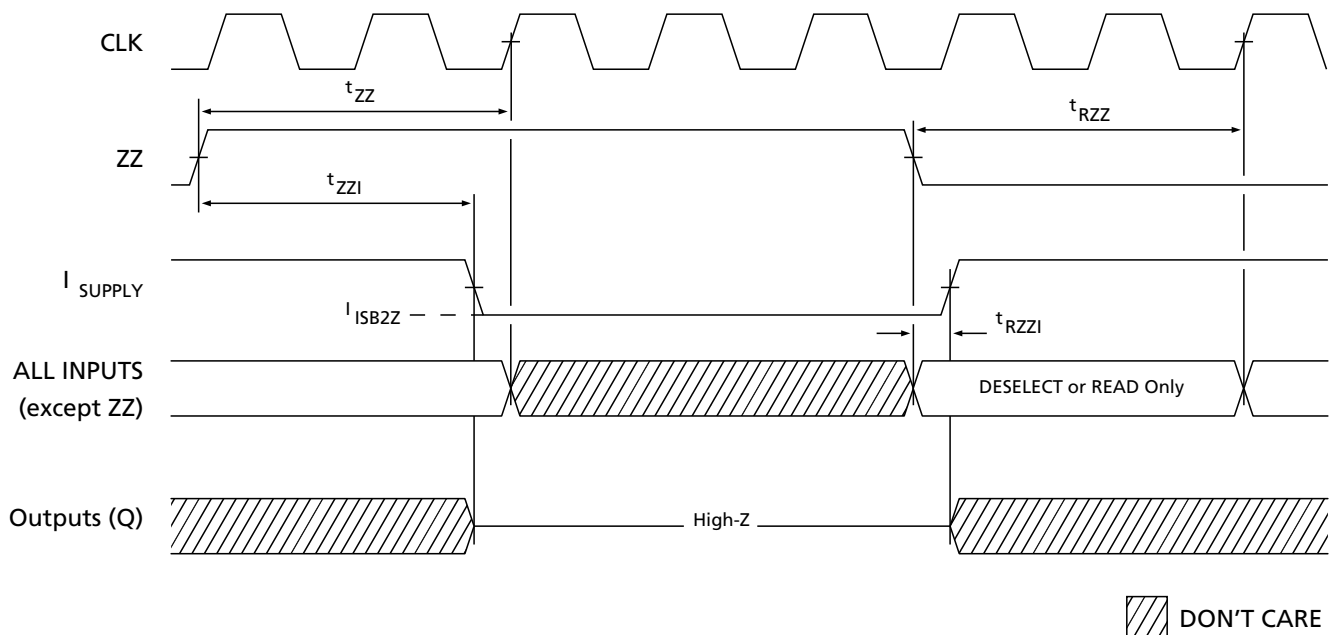

3.3V VDD, 3.3V I/O AC Test Conditions

Input pulse levels $V_{IH} = (V_{DD}/2.2) + 1.5V$
 $V_{IL} = (V_{DD}/2.2) - 1.5V$
 Input rise and fall times 1ns
 Input timing reference levels..... $V_{DD}/2.2$
 Output reference levels..... $V_{DDQ}/2.2$
 Output load..... See Figures 11 and 12

3.3V VDD, 2.5V I/O AC Test Conditions

Input pulse levels $V_{IH} = (V_{DD}/2.64) + 1.25V$
 $V_{IL} = (V_{DD}/2.64) - 1.25V$
 Input rise and fall times 1ns
 Input timing reference levels..... $V_{DD}/2.64$
 Output reference levels..... $V_{DDQ}/2$
 Output load..... See Figures 13 and 14

2.5V VDD, 2.5V I/O AC Test Conditions

Input pulse levels..... $V_{IH} = (V_{DD}/2) + 1.25V$
 $V_{IL} = (V_{DD}/2) - 1.25V$
 Input rise and fall times 1ns
 Input timing reference levels..... $V_{DD}/2$
 Output reference levels..... $V_{DDQ}/2$
 Output load..... See Figures 13 and 14

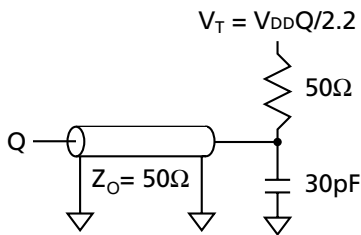
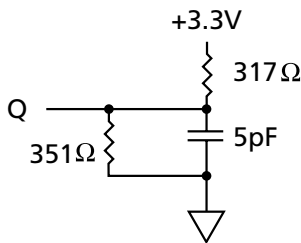
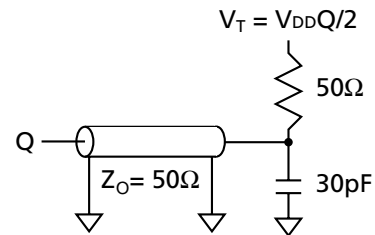
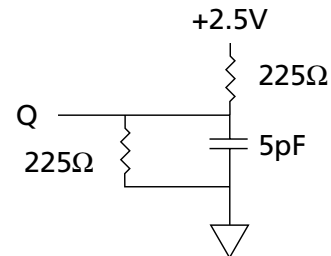
3.3V I/O Output Load Equivalent
Figure 11:

Figure 12:

2.5V I/O Output Load Equivalent
Figure 13:

Figure 14:

NOTE:

For Figures 11 and 13, 30pF = distributive test jig capacitance.

IEEE 1149.1 Serial Boundary Scan (JTAG)

The SRAM incorporates a serial boundary scan test access port (TAP). This port operates in accordance with IEEE Standard 1149.1-1990 but does not have the set of functions required for full 1149.1 compliance. These functions from the IEEE specification are excluded because their inclusion places an added delay in the critical speed path of the SRAM. Note that the TAP controller functions in a manner that does not conflict with the operation of other devices using 1149.1 fully compliant TAPs. The TAP operates using JEDEC-standard 3.3V or 2.5V I/O logic levels.

The SRAM contains a TAP controller, instruction register, boundary scan register, bypass register, and ID register.

Disabling the JTAG Feature

These balls can be left floating (unconnected), if the JTAG function is not to be implemented. Upon power-up, the device will come up in a reset state which will not interfere with the operation of the device.

Figure 15: TAP Controller State Diagram

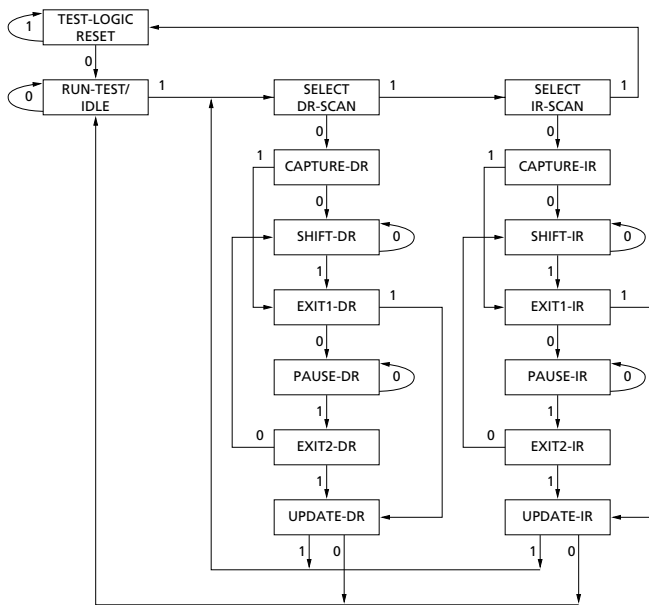

NOTE:
The 0/1 next to each state represents the value of TMS at the rising edge of TCK.

Test Access Port (TAP)

Test Clock (TCK)

The test clock is used only with the TAP controller. All inputs are captured on the rising edge of TCK. All outputs are driven from the falling edge of TCK.

Test MODE SELECT (TMS)

The TMS input is used to give commands to the TAP controller and is sampled on the rising edge of TCK. It is allowable to leave this ball unconnected if the TAP is not used. The ball is pulled up internally, resulting in a logic HIGH level.

Test Data-In (TDI)

The TDI ball is used to serially input information into the registers and can be connected to the input of any of the registers. The register between TDI and TDO is chosen by the instruction that is loaded into the TAP instruction register. For information on loading the instruction register, see Figure 15. TDI is internally pulled up and can be unconnected if the TAP is unused in an application. TDI is connected to the most significant bit (MSB) of any register. (See Figure 16.)

Test Data-Out (TDO)

The TDO output ball is used to serially clock data-out from the registers. The output is active depending upon the current state of the TAP state machine. (See Figure 15.) The output changes on the falling edge of TCK. TDO is connected to the least significant bit (LSB) of any register. (See Figure 16.)

Figure 16: TAP Controller Block Diagram

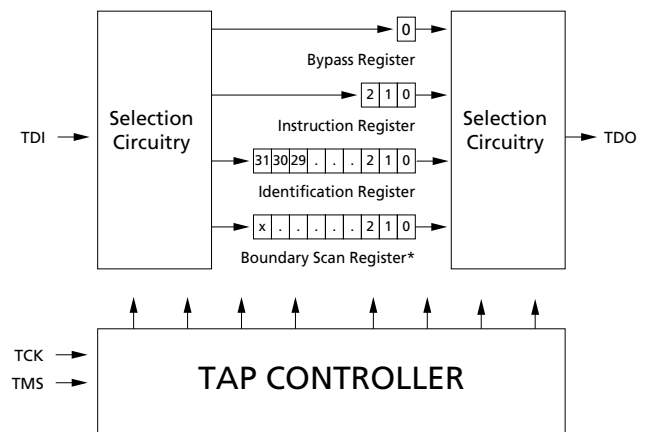

NOTE:
X = 74 for all configurations.

Performing a TAP Reset

A RESET is performed by forcing TMS HIGH (V_{DD}) for five rising edges of TCK. This RESET does not affect the operation of the SRAM and may be performed while the SRAM is operating.

At power-up, the TAP is reset internally to ensure that TDO comes up in a High-Z state.

TAP REGISTERS

Registers are connected between the TDI and TDO balls and allow data to be scanned into and out of the SRAM test circuitry. Only one register can be selected at a time through the instruction register. Data is serially loaded into the TDI ball on the rising edge of TCK. Data is output on the TDO ball on the falling edge of TCK.

Instruction Register

Three-bit instructions can be serially loaded into the instruction register. This register is loaded when it is placed between the TDI and TDO balls as shown in Figure 16. Upon power-up, the instruction register is loaded with the IDCODE instruction. It is also loaded with the IDCODE instruction if the controller is placed in a reset state as described in the previous section.

When the TAP controller is in the Capture-IR state, the two LSBs are loaded with a binary “01” pattern to allow for fault isolation of the board-level serial test data path.

Bypass Register

To save time when serially shifting data through registers, it is sometimes advantageous to skip certain chips. The bypass register is a single-bit register that can be placed between the TDI and TDO balls. This allows data to be shifted through the SRAM with minimal delay. The bypass register is set LOW (V_{SS}) when the BYPASS instruction is executed.

Boundary Scan Register

The boundary scan register is connected to all the input and bidirectional balls on the SRAM. The SRAM as a 75 bit-long register.

The boundary scan register is loaded with the contents of the RAM I/O ring when the TAP controller is in the Capture-DR state and is then placed between the TDI and TDO balls when the controller is moved to the Shift-DR state. The EXTEST, SAMPLE/PRELOAD and SAMPLE Z instructions can be used to capture the contents of the I/O ring.

The Boundary Scan Order tables show the order in which the bits are connected. Each bit corresponds to one of the balls on the SRAM package. The MSB of the register is connected to TDI, and the LSB is connected to TDO.

Identification (ID) Register

The ID register is loaded with a vendor-specific, 32-bit code during the Capture-DR state when the IDCODE command is loaded in the instruction register. The IDCODE is hardwired into the SRAM and can be shifted out when the TAP controller is in the Shift-DR state. The ID register has a vendor code and other information described in the Identification Register Definitions table.

TAP Instruction Set Overview

Eight different instructions are possible with the three-bit instruction register. All combinations are listed in the Instruction Codes table. Three of these instructions are listed as RESERVED and should not be used. The other five instructions are described in detail below.

The TAP controller used in this SRAM is not fully compliant to the 1149.1 convention because some of the mandatory 1149.1 instructions are not fully implemented. The TAP controller cannot be used to load address, data or control signals into the SRAM and cannot preload the I/O buffers. The SRAM does not implement the 1149.1 commands EXTEST or INTEST or the PRELOAD portion of SAMPLE/PRELOAD; rather, it performs a capture of the I/O ring when these instructions are executed.

Instructions are loaded into the TAP controller during the Shift-IR state when the instruction register is placed between TDI and TDO. During this state, instructions are shifted through the instruction register through the TDI and TDO balls. To execute the instruction once it is shifted in, the TAP controller needs to be moved into the Update-IR state.

EXTEST

EXTEST is a mandatory 1149.1 instruction which is to be executed whenever the instruction register is loaded with all 0s. EXTEST is not implemented in this SRAM TAP controller, and therefore this device is not compliant to 1149.1.

The TAP controller does not recognize an all-0 instruction. When an EXTEST instruction is loaded into the instruction register, the SRAM responds as if a SAMPLE/PRELOAD instruction has been loaded. There is one difference between the two instructions. Unlike the SAMPLE/PRELOAD instruction, EXTEST places the SRAM outputs in a High-Z state.

IDCODE

The IDCODE instruction causes a vendor-specific, 32-bit code to be loaded into the instruction register. It also places the instruction register between the TDI and TDO balls and allows the IDCODE to be shifted out of the device when the TAP controller enters the Shift-DR state. The IDCODE instruction is loaded into the instruction register upon power-up or whenever the TAP controller is given a test logic reset state.

SAMPLE Z

The SAMPLE Z instruction causes the boundary scan register to be connected between the TDI and TDO balls when the TAP controller is in a Shift-DR state. It also places all SRAM outputs into a High-Z state.

SAMPLE/PRELOAD

SAMPLE/PRELOAD is a 1149.1 mandatory instruction. The PRELOAD portion of this instruction is not implemented, so the device TAP controller is not fully 1149.1-compliant.

When the SAMPLE/PRELOAD instruction is loaded into the instruction register and the TAP controller is in

the Capture-DR state, a snapshot of data on the inputs and bidirectional balls is captured in the boundary scan register.

The user must be aware that the TAP controller clock can only operate at a frequency up to 10 MHz, while the SRAM clock operates more than an order of magnitude faster. Because there is a large difference in the clock frequencies, it is possible that during the Capture-DR state, an input or output will undergo a transition. The TAP may then try to capture a signal while in transition (metastable state). This will not harm the device, but there is no guarantee as to the value that will be captured. Repeatable results may not be possible.

To guarantee that the boundary scan register will capture the correct value of a signal, the SRAM signal must be stabilized long enough to meet the TAP controller's capture setup plus hold time (t_{CS} plus t_{CH}). The SRAM clock input might not be captured correctly if there is no way in a design to stop (or slow) the clock during a SAMPLE/PRELOAD instruction. If this is an issue, it is still possible to capture all other signals and simply ignore the value of the CLK captured in the boundary scan register.

Once the data is captured, it is possible to shift out the data by putting the TAP into the Shift-DR state. This places the boundary scan register between the TDI and TDO balls.

Note that since the PRELOAD part of the command is not implemented, putting the TAP to the Update-DR state while performing a SAMPLE/PRELOAD instruction will have the same effect as the Pause-DR command.

BYPASS

When the BYPASS instruction is loaded in the instruction register and the TAP is placed in a Shift-DR state, the bypass register is placed between the TDI and TDO balls. The advantage of the BYPASS instruction is that it shortens the boundary scan path when multiple devices are connected together on a board.

Reserved

These instructions are not implemented but are reserved for future use. Do not use these instructions.

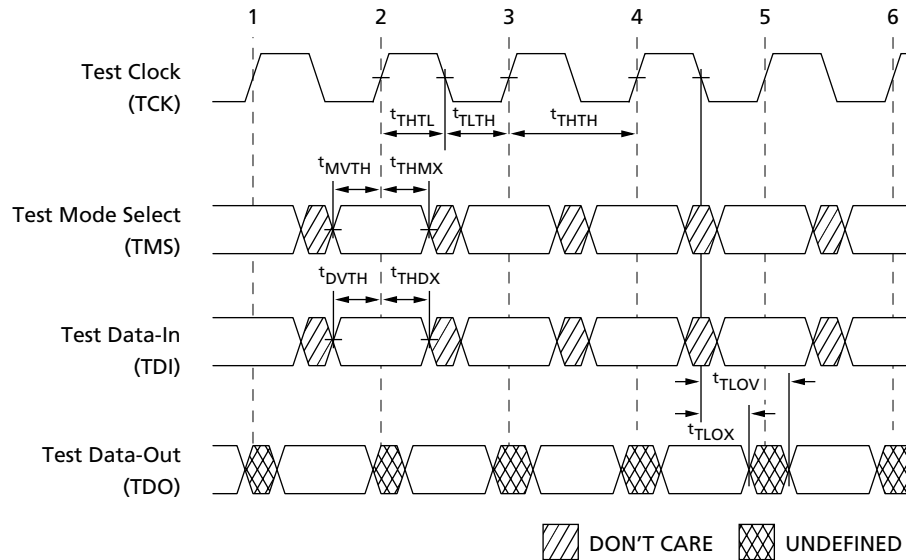
**Figure 17:
TAP Timing**

Table 19: TAP AC Electrical Characteristics

 Notes 1, 2; $0^{\circ}\text{C} \leq T_A \leq +70^{\circ}\text{C}$; $V_{DD} = 3.3\text{V} \pm 0.165\text{V}$ or $2.5\text{V} \pm 0.125\text{V}$

DESCRIPTION	SYMBOL	MIN	MAX	UNITS
Clock				
Clock cycle time	t_{THTH}	100		ns
Clock frequency	f_{TF}		10	MHz
Clock HIGH time	t_{THTL}	40		ns
Clock LOW time	t_{TLTH}	40		ns
Output Times				
TCK LOW to TDO unknown	t_{TLOX}	0		ns
TCK LOW to TDO valid	t_{TLOV}		20	ns
TDI valid to TCK HIGH	t_{DVTH}	10		ns
TCK HIGH to TDI invalid	t_{THDX}	10		ns
Setup Times				
TMS setup	t_{MVTH}	10		ns
Capture setup	t_{CS}	10		ns
Hold Times				
TMS hold	t_{THMX}	10		ns
Capture hold	t_{CH}	10		ns

NOTE:

- t_{CS} and t_{CH} refer to the setup and hold time requirements of latching data from the boundary scan register.
- Test conditions are specified using the loads in Figures Table 18 and 19.

3.3V TAP AC Test Conditions

Input Pulse Levels V_{ss} to 3.0V
 Input rise and fall times 1ns
 Input timing reference levels..... 1.5V
 Output reference levels 1.5V
 Test load termination supply voltage 1.5V

2.5V TAP AC Test Conditions

Input Pulse Levels..... V_{ss} to 2.5V
 Input rise and fall times 1ns
 Input timing reference levels..... 1.25V
 Output reference levels 1.25V
 Test load termination supply voltage 1.25V

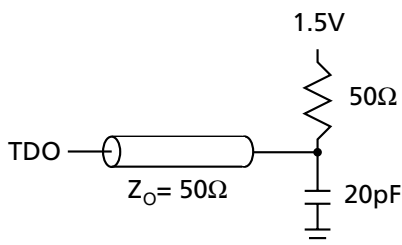
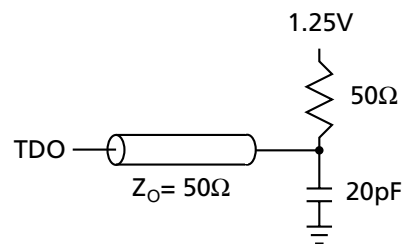
Figure 18:
3.3V TAP AC Output Load Equivalent

Figure 19:
2.5V TAP AC Output Load Equivalent

Table 20: 3.3V V_{DD}, TAP DC Electrical Characteristics and Operating Conditions

0°C ≤ T_A ≤ +70°C; V_{DD} = 3.3V ±0.165V unless otherwise noted

DESCRIPTION	CONDITIONS	SYMBOL	MIN	MAX	UNITS	NOTES
Input High (Logic 1) Voltage		V _{IH}	2.0	V _{DD} + 0.3	V	1, 2
Input Low (Logic 0) Voltage		V _{IL}	-0.3	0.8	V	1, 2
Input Leakage Current	0V ≤ V _{IN} ≤ V _{DD}	I _{LI}	-10	10	μA	2
Output Leakage Current	Output(s) disabled, 0V ≤ V _{IN} ≤ V _{DD} (TDO)	I _{LO}	-10	10	μA	2
Output Low Voltage	I _{OLC} = 100μA	V _{OL1}		0.7	V	1, 2
	I _{OLT} = 2mA	V _{OL2}		0.8	V	1, 2
Output High Voltage	I _{OHC} = -100μA	V _{OH1}	2.9		V	1, 2
	I _{OHT} = -2mA	V _{OH2}	2.0		V	1, 2

Table 21: 2.5V V_{DD}, TAP DC Electrical Characteristics and Operating Conditions

0°C ≤ T_A ≤ +70°C; V_{DD} = 2.5V ±0.125V unless otherwise noted

DESCRIPTION	CONDITIONS	SYMBOL	MIN	MAX	UNITS	NOTES
Input High (Logic 1) Voltage		V _{IH}	1.7	V _{DD} + 0.3	V	1, 2
Input Low (Logic 0) Voltage		V _{IL}	-0.3	0.7	V	1, 2
Input Leakage Current	0V ≤ V _{IN} ≤ V _{DD}	I _{LI}	-10	10	μA	2
Output Leakage Current	Output(s) disabled, 0V ≤ V _{IN} ≤ V _{DD} (TDO)	I _{LO}	-10	10	μA	2
Output Low Voltage	I _{OLC} = 100μA	V _{OL1}		0.2	V	1, 2
	I _{OLT} = 2mA	V _{OL2}		0.7	V	1, 2
Output High Voltage	I _{OHC} = -100μA	V _{OH1}	2.1		V	1, 2
	I _{OHT} = -2mA	V _{OH2}	1.7		V	1, 2

NOTE:

- All voltages referenced to V_{ss} (GND).
- TAP control balls only. For boundary scan ball specifications, please refer to the I/O DC Electrical Characteristics and Operation Conditions tables.

Table 22: Identification Register Definitions

INSTRUCTION FIELD	BIT CONFIGURATION	DESCRIPTION
Revision Number (31:28)	0000	Reserved for version number.
Device Depth (27:23)	00111 00110	Defines depth of 1Mb. Defines depth of 512K.
Device Width (22:18)	00011 00100	Defines width of x18 bits. Defines width of x 32 or x36 bits.
Micron Device ID (17:12)	xxxxxx	Reserved for future use.
Micron JEDEC ID Code (11:1)	00000101100	Allows unique identification of SRAM vendor.
ID Register Presence Indicator (0)	1	Indicates the presence of an ID register.

Table 23: Scan Register Sizes

REGISTER NAME	BIT SIZE
Instruction	3
Bypass	1
ID	32
Boundary Scan: x18, x32, x36	75

Table 24: Instruction Codes

INSTRUCTION	CODE	DESCRIPTION
EXTEST	000	Captures I/O ring contents. Places the boundary scan register between TDI and TDO. Forces all SRAM outputs to High-Z state. This instruction is not 1149.1-compliant.
IDCODE	001	Loads the ID register with the vendor ID code and places the register between TDI and TDO. This operation does not affect SRAM operations.
SAMPLE Z	010	Captures I/O ring contents. Places the boundary scan register between TDI and TDO. Forces all SRAM output drivers to a High-Z state.
RESERVED	011	Do Not Use: This instruction is reserved for future use.
SAMPLE/PRELOAD	100	Captures I/O ring contents. Places the boundary scan register between TDI and TDO. Does not affect SRAM operation. This instruction does not implement 1149.1 preload function and is therefore not 1149.1-compliant.
RESERVED	101	Do Not Use: This instruction is reserved for future use.
RESERVED	110	Do Not Use: This instruction is reserved for future use.
BYPASS	111	Places the bypass register between TDI and TDO. This operation does not affect SRAM operations.

Table 25: 165-Ball FBGA Boundary Scan Order (x18)

BIT#	SIGNAL NAME	BALL ID
1	MODE (LBO#)	1R
2	NF	6N
3	NF	11P
4	SA	8R
5	SA	8P
6	SA	9R
7	SA	9P
8	SA	10R
9	SA	10P
10	SA	11R
11	ZZ	11H
12	NC	11N
13	NC	11M
14	NC	11L
15	NC	11K
16	NC	11J
17	DQa	10M
18	DQa	10L
19	DQa	10K
20	DQa	10J
21	DQa	11G
22	DQa	11F
23	DQa	11E
24	DQa	11D
25	DQP _a	11C
26	NC	10F
27	NC	10E
28	NC	10D
29	NC	10G
30	SA	11A
31	SA	10B
32	SA	10A
33	SA	9A
34	SA	9B
35	ADV/LD#	8A
36	OE# (G#)	8B
37	CKE#	7A
38	R/W#	7B

BIT#	SIGNAL NAME	BALL ID
39	CLK	6B
40	NC	11B
41	NC	1A
42	CE2#	6A
43	BW _a #	5B
44	NC	5A
45	BW _b #	4A
46	NC	4B
47	CE2	3B
48	CE#	3A
49	SA	2A
50	SA	2B
51	NC	1B
52	NC	1C
53	NC	1D
54	NC	1E
55	NC	1F
56	NC	1G
57	DQ _b	2D
58	DQ _b	2E
59	DQ _b	2F
60	DQ _b	2G
61	DQ _b	1J
62	DQ _b	1K
63	DQ _b	1L
64	DQ _b	1M
65	DQP _b	1N
66	NC	2K
67	NC	2L
68	NC	2M
69	NC	2J
70	SA	3P
71	SA	3R
72	SA	4P
73	SA	4R
74	SA1	6P
75	SA0	6R

Table 26: 165-Ball FBGA Boundary Scan Order (x32)

BIT#	SIGNAL NAME	BALL ID
1	MODE (LB0#)	1R
2	NF	6N
3	NF	11P
4	SA	8R
5	SA	8P
6	SA	9R
7	SA	9P
8	SA	10R
9	SA	10P
10	SA	11R
11	ZZ	11H
12	NF	11N
13	DQa	11M
14	DQa	11L
15	DQa	11K
16	DQa	11J
17	DQa	10M
18	DQa	10L
19	DQa	10K
20	DQa	10J
21	DQb	11G
22	DQb	11F
23	DQb	11E
24	DQb	11D
25	DQb	10G
26	DQb	10F
27	DQb	10E
28	DQb	10D
29	NF	11C
30	NC	11A
31	SA	10B
32	SA	10A
33	SA	9A
34	SA	9B
35	ADV/LD#	8A
36	OE# (G#)	8B
37	CKE#	7A
38	R/W#	7B

BIT#	SIGNAL NAME	BALL ID
39	CLK	6B
40	NC	11B
41	NC	1A
42	CE2#	6A
43	BWa#	5B
44	BWb#	5A
45	BWc#	4A
46	BWd#	4B
47	CE2	3B
48	CE#	3A
49	SA	2A
50	SA	2B
51	NC	1B
52	NF	1C
53	DQc	1D
54	DQc	1E
55	DQc	1F
56	DQc	1G
57	DQc	2D
58	DQc	2E
59	DQc	2F
60	DQc	2G
61	DQd	1J
62	DQd	1K
63	DQd	1L
64	DQd	1M
65	DQd	2J
66	DQd	2K
67	DQd	2L
68	DQd	2M
69	NF	1N
70	SA	3P
71	SA	3R
72	SA	4P
73	SA	4R
74	SA1	6P
75	SA0	6R

Table 27: 165-Ball FBGA Boundary Scan Order (x36)

BIT#	SIGNAL NAME	BALL ID
1	MODE (LB0#)	1R
2	NF	6N
3	NF	11P
4	SA	8R
5	SA	8P
6	SA	9R
7	SA	9P
8	SA	10R
9	SA	10P
10	SA	11R
11	ZZ	11H
12	DQP _a	11N
13	DQ _a	11M
14	DQ _a	11L
15	DQ _a	11K
16	DQ _a	11J
17	DQ _a	10M
18	DQ _a	10L
19	DQ _a	10K
20	DQ _a	10J
21	DQ _b	11G
22	DQ _b	11F
23	DQ _b	11E
24	DQ _b	11D
25	DQ _b	10G
26	DQ _b	10F
27	DQ _b	10E
28	DQ _b	10D
29	DQP _b	11C
30	NC	11A
31	SA	10B
32	SA	10A
33	SA	9A
34	SA	9B
35	ADV/LD#	8A
36	OE# (G#)	8B
37	CKE#	7A
38	R/W#	7B

BIT#	SIGNAL NAME	BALL ID
39	CLK	6B
40	NC	11B
41	NC	1A
42	CE2#	6A
43	BW _a #	5B
44	BW _b #	5A
45	BW _c #	4A
46	BW _d #	4B
47	CE2	3B
48	CE#	3A
49	SA	2A
50	SA	2B
51	NC	1B
52	DQP _c	1C
53	DQ _c	1D
54	DQ _c	1E
55	DQ _c	1F
56	DQ _c	1G
57	DQ _c	2D
58	DQ _c	2E
59	DQ _c	2F
60	DQ _c	2G
61	DQ _d	1J
62	DQ _d	1K
63	DQ _d	1L
64	DQ _d	1M
65	DQ _d	2J
66	DQ _d	2K
67	DQ _d	2L
68	DQ _d	2M
69	DQP _d	1N
70	SA	3P
71	SA	3R
72	SA	4P
73	SA	4R
74	SA1	6P
75	SA0	6R

**Figure 20: 100-Pin Plastic TQFP
(JEDEC LQFP)**

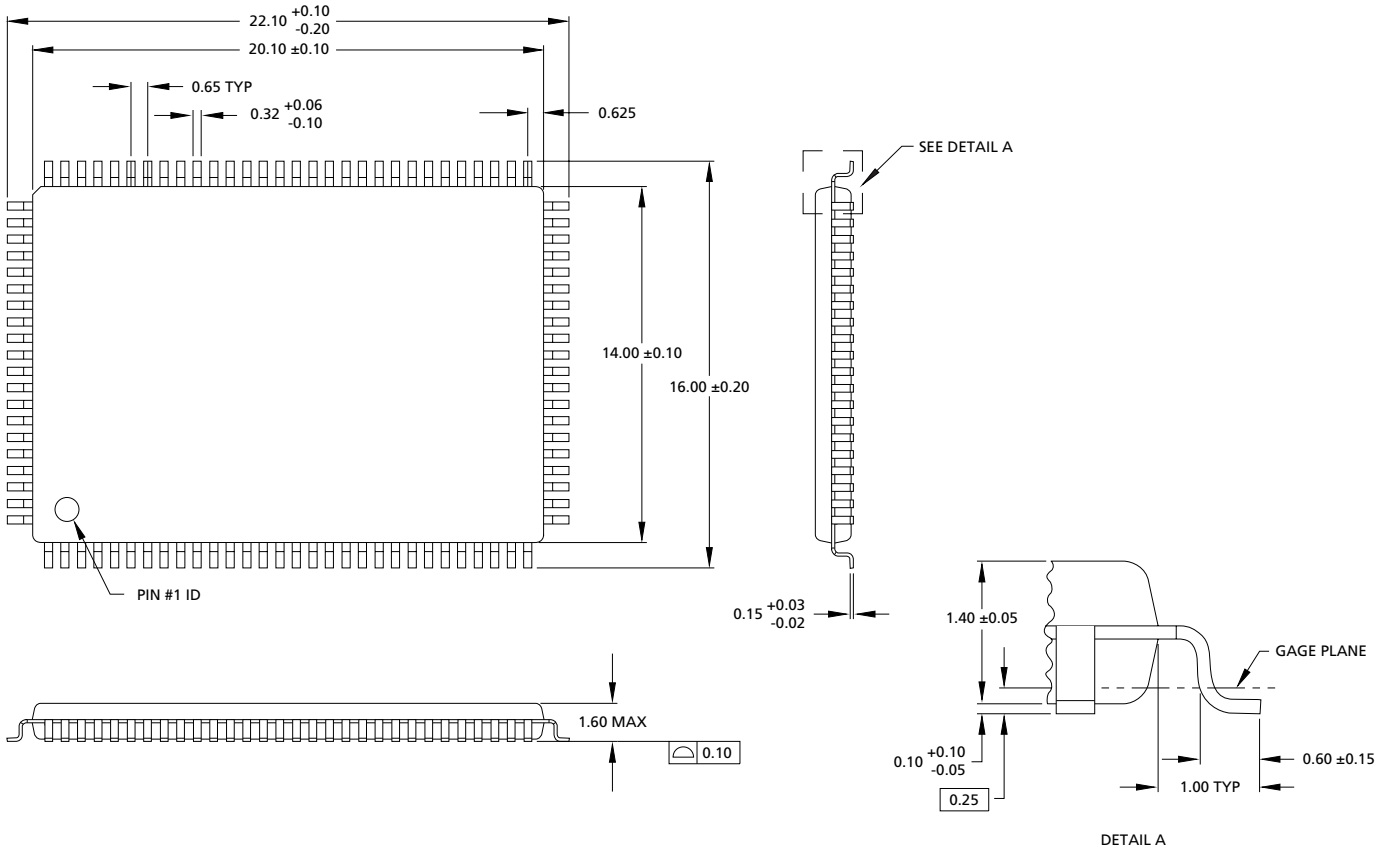

NOTE:

1. All dimensions in inches (millimeters) $\frac{\text{MAX}}{\text{MIN}}$ or typical where noted.
2. Package width and length do not include mold protrusion; allowable mold protrusion is 0.25mm per side.

**Figure 21:
165-Ball FBGA**

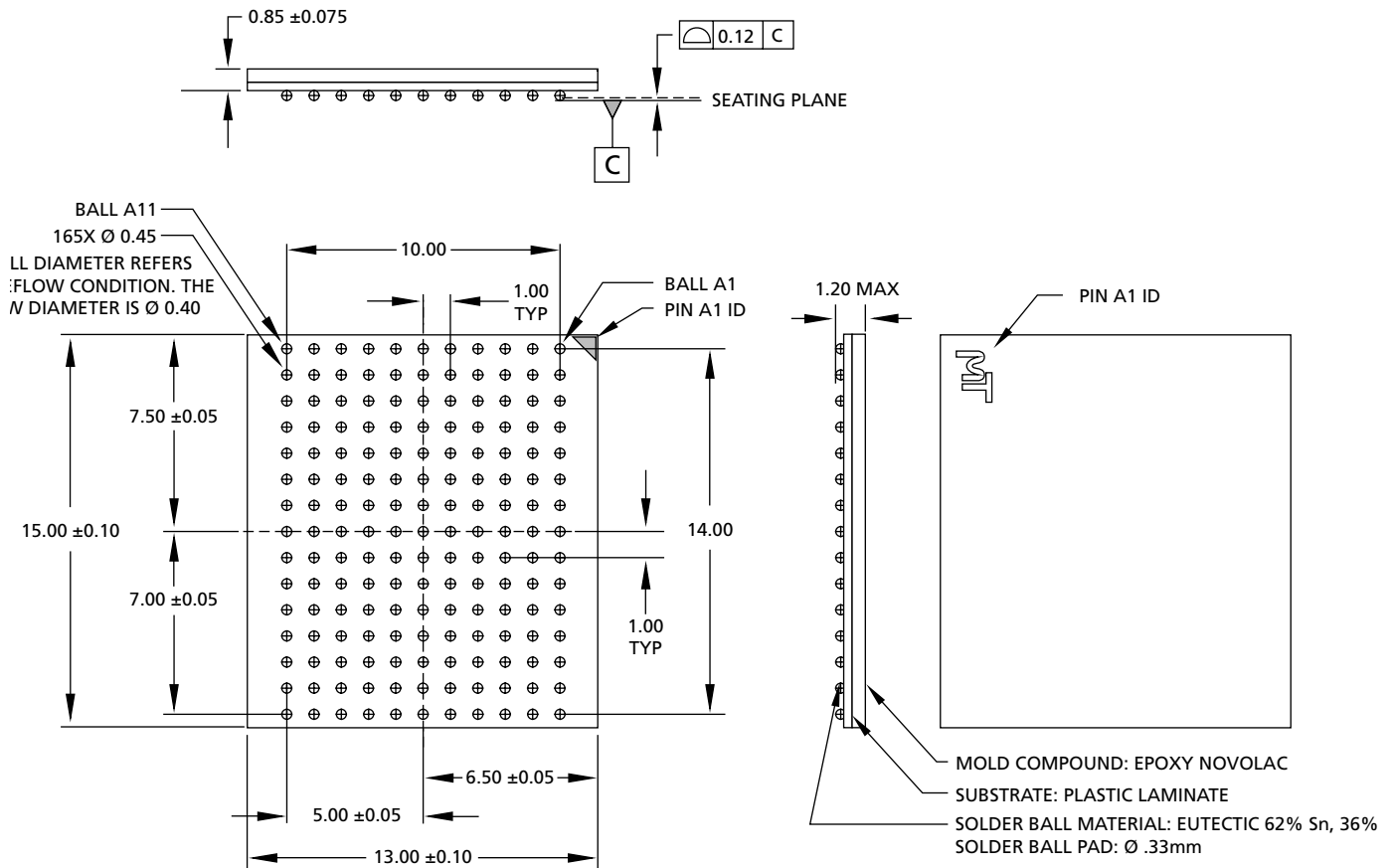

NOTE:

1. All dimensions in inches (millimeters) $\frac{MAX}{MIN}$ or typical where noted.

Data Sheet Designation

No Marking: This data sheet contains minimum and maximum limits specified over the complete power supply and temperature range for production devices. Although considered final, these specifications are subject to change, as further product development and data characterization sometimes occur.



8000 S. Federal Way, P.O. Box 6, Boise, ID 83707-0006, Tel: 208-368-3900

E-mail: prodmktg@micron.com, Internet: <http://www.micron.com>, Customer Comment Line: 800-932-4992

Micron, the M logo, and the Micron logo are trademarks and/or service marks of Micron Technology, Inc.

ZBT and Zero Bus Turnaround are trademarks of Integrated Device Technology, Inc., and the architecture is supported by Micron Technology, Inc., and Motorola, Inc.

Document Revision History

- Rev D; Pub. 2/032/03
Changed designation from Preliminary to Production

- Rev C; Pub. 12/0212/02
Added T_j specifications to the AC Electrical Characteristics table
Corrected Boundary Scan errors
Updated TQFP and FBGA Thermal Resistance values
Corrected grammatical errors

- Rev B; PRELIMINARY11/02
Changed designation from ADVANCE to PRELIMINARY
Corrected grammatical errors

- New ADVANCE data sheet for 0.16μm process; Rev A; Pub. 6/026/02