

NLAST4501

Single SPST Analog Switch

The NLAST4501 is an analog switch manufactured in sub-micron silicon-gate CMOS technology. It achieves very low R_{ON} while maintaining extremely low power dissipation. The device is a bilateral switch suitable for switching either analog or digital signals, which may vary from zero to full supply voltage.

The NLAST4501 is a low voltage, TTL (low threshold) compatible device, pin for pin compatible with the MAX4501.

The Enable pin is compatible with standard TTL level outputs when supply voltage is nominal 5.0 V. It is also over-voltage tolerant, making it a very useful logic level translator.

Features

- Guaranteed R_{ON} of 32Ω at 5.5 V
- Low Power Dissipation: $I_{CC} = 2 \mu A$
- Low Threshold Enable pin TTL compatible at 5.0 V
- TTL version and pin for pin with NLAS4501
- Provides Voltage translation for many different voltage levels
 - 3.3 to 5.0 V, Enable pin may go as high as +5.5 V
 - 1.8 to 3.3 V
 - 1.8 to 2.5 V
- Improved version of MAX4501 (at any voltage between 2 and 5.5 V)
- Chip Complexity: FETs = 11
- Pb-Free Packages are Available

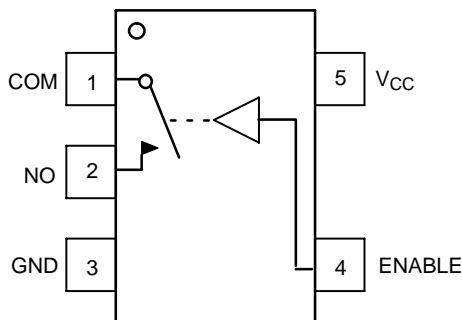

Figure 1. Pinout (Top View)



ON Semiconductor®

<http://onsemi.com>

MARKING DIAGRAMS

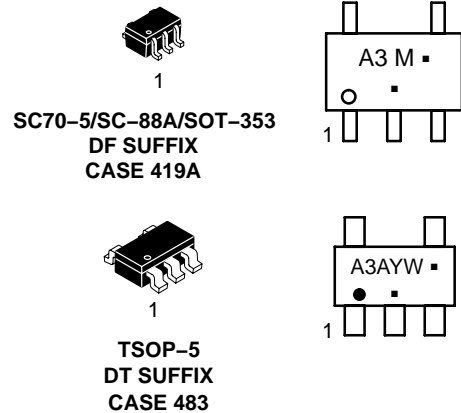

A3 = Specific Device Code
 M = Date Code*
 A = Assembly Location
 Y = Year
 W = Work Week
 ■ = Pb-Free Package

(Note: Microdot may be in either location)

*Date Code orientation and/or position and underbar may vary depending upon manufacturing location.

PIN ASSIGNMENT

Pin	Function
1	COM
2	NO
3	GND
4	ENABLE
5	V_{CC}

FUNCTION TABLE

On/Off Enable Input	State of Analog Switch
L	Off
H	On

ORDERING INFORMATION

See detailed ordering and shipping information on page 8 of this data sheet.

NLAST4501

MAXIMUM RATINGS

Rating	Symbol	Value	Unit
Positive DC Supply Voltage	V_{CC}	-0.5 to +7.0	V
Digital Input Voltage (Enable)	V_{IN}	-0.5 to +7.0	V
Analog Output Voltage (V_{NO} or V_{COM})	V_{IS}	-0.5 to $V_{CC} + 0.5$	V
DC Current, Into or Out of Any Pin	I_{IK}	± 20	mA
Storage Temperature Range	T_{STG}	-65 to +150	$^{\circ}C$
Lead Temperature, 1 mm from Case for 10 Seconds	T_L	260	$^{\circ}C$
Junction Temperature under Bias	T_J	+150	$^{\circ}C$
Thermal Resistance	SC70-5/SC-88A (Note 1) TSOP-5	θ_{JA} 350 230	$^{\circ}C/W$
Power Dissipation in Still Air at 85 $^{\circ}C$	SC70-5/SC-88A TSOP-5	P_D 150 200	mW
Moisture Sensitivity	MSL	Level 1	
Flammability Rating	Oxygen Index: 30% - 35%	F_R	UL 94 V-0 @ 0.125 in
ESD Withstand Voltage	Human Body Model (Note 2) Machine Model (Note 3) Charged Device Model (Note 4)	V_{ESD} > 2000 > 100 N/A	V
Latchup Performance	Above V_{CC} and Below GND at 85 $^{\circ}C$ (Note 5)	$I_{Latchup}$	± 300 mA

Stresses exceeding Maximum Ratings may damage the device. Maximum Ratings are stress ratings only. Functional operation above the Recommended Operating Conditions is not implied. Extended exposure to stresses above the Recommended Operating Conditions may affect device reliability.

1. Measured with minimum pad spacing on an FR4 board, using 10 mm-by-1 inch, 2-ounce copper trace with no air flow.
2. Tested to EIA/JESD22-A114-A.
3. Tested to EIA/JESD22-A115-A.
4. Tested to JESD22-C101-A.
5. Tested to EIA/JESD78.

RECOMMENDED OPERATING CONDITIONS

Parameter	Symbol	Min	Max	Unit
Positive DC Supply Voltage	V_{CC}	2.0	5.5	V
Digital Input Voltage (Enable)	V_{IN}	GND	5.5	V
Static or Dynamic Voltage Across an Off Switch	V_{IO}	GND	V_{CC}	V
Analog Input Voltage (NO, COM)	V_{IS}	GND	V_{CC}	V
Operating Temperature Range, All Package Types	T_A	-55	+125	$^{\circ}C$
Input Rise or Fall Time, (Enable Input)	t_r, t_f	$V_{CC} = 3.3 V \pm 0.3 V$ 0	100 20	ns/V

DEVICE JUNCTION TEMPERATURE VERSUS TIME TO 0.1% BOND FAILURES

Junction Temperature $^{\circ}C$	Time, Hours	Time, Years
80	1,032,200	117.8
90	419,300	47.9
100	178,700	20.4
110	79,600	9.4
120	37,000	4.2
130	17,800	2.0
140	8,900	1.0

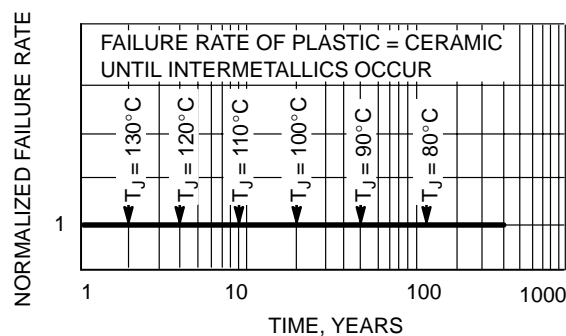

Figure 2. Failure Rate vs. Time Junction Temperature

NLAST4501

DC CHARACTERISTICS – Digital Section (Voltages Referenced to GND)

Parameter	Condition	Symbol	V _{CC}	Guaranteed Max Limit			Unit
				–55°C to 25°C	< 85°C	< 125°C	
Minimum High-Level Input Voltage, Enable Inputs		V _{IH}	3.0	1.4	1.4	1.4	V
			4.5	2.0	2.0	2.0	
			5.5	2.0	2.0	2.0	
Maximum Low-Level Input Voltage, Enable Inputs		V _{IL}	3.0	0.53	0.53	0.53	V
			4.5	0.8	0.8	0.8	
			5.5	0.8	0.8	0.8	
Maximum Input Leakage Current, Enable Inputs	V _{IN} = 5.5 V or GND	I _{IN}	0 V to 5.5 V	±0.1	±1.0	±1.0	µA
Maximum Quiescent Supply Current (per package)	Enable and VIS = V _{CC} or GND	I _{CC}	5.5	1.0	1.0	2.0	µA

DC ELECTRICAL CHARACTERISTICS – Analog Section

Parameter	Condition	Symbol	V _{CC}	Guaranteed Max Limit			Unit
				–55°C to 25°C	< 85°C	< 125°C	
Maximum ON Resistance (Figures 8 – 12)	V _{IN} = V _{IH} V _{IS} = V _{CC} to GND I _{IS} ≤ 10.0mA	R _{ON}	3.0	45	50	55	Ω
			4.5	30	35	40	
			5.5	25	30	35	
ON Resistance Flatness	V _{IN} = V _{IH} I _{IS} ≤ 10.0 mA V _{IS} = 1 V, 2 V, 3.5 V	R _{FLAT(ON)}	4.5	4	4	5	Ω
Off Leakage Current, Pin 2 (Figure 3)	V _{IN} = V _{IL} V _{NO} = 1.0 V, V _{COM} = 4.5 V or V _{COM} = 1.0 V and V _{NO} 4.5 V	I _{NO(OFF)}	5.5	1	10	100	nA
Off Leakage Current, Pin 1 (Figure 3)	V _{IN} = V _{IL} V _{NO} = 4.5 V or 1.0 V V _{COM} = 1.0 V or 4.5 V	I _{COM(OFF)}	5.5	1	10	100	nA

AC ELECTRICAL CHARACTERISTICS (Input t_r = t_f = 3.0 ns)

Parameter	Test Conditions	Symbol	V _{CC} (V)	Guaranteed Max Limit									Unit
				–55°C to 25°C			< 85°C			< 125°C			
				Min	Typ	Max	Min	Typ	Max	Min	Typ	Max	
Turn-On Time	R _L = 300 Ω, C _L = 35 pF (Figures 4, 5, and 13)	t _{ON}	2.0		7.0	14			16			16	ns
			3.0		5.0	10			12			12	
			4.5		4.5	9			11			11	
			5.5		4.5	9			11			11	
Turn-Off Time	R _L = 300 Ω, C _L = 35 pF (Figures 4, 5, and 13)	t _{OFF}	2.0		11.0	22			24			24	ns
			3.0		7.0	14			16			16	
			4.5		5.0	10			12			12	
			5.5		5.0	10			12			12	
Typical @ 25, VCC = 5.0 V													
Maximum Input Capacitance, Select Input	C _{IN}							8				pF	
Analog I/O (switch off)	C _{NO} or C _{NC}							10					
Common I/O (switch off)	C _{COM(OFF)}							10					
Feedthrough (switch on)	C _{COM(ON)}							20					

NLAST4501

ADDITIONAL APPLICATION CHARACTERISTICS (Voltages Referenced to GND Unless Noted)

Parameter	Condition	Symbol	V _{CC} V	Limit 25°C	Unit
Maximum On-Channel -3dB Bandwidth or Minimum Frequency Response	V _{IS} = 0 dBm V _{IS} centered between V _{CC} and GND (Figures 6 and 14)	BW	3.0 4.5 5.5	190 200 220	MHz
Maximum Feedthrough On Loss	V _{IS} = 0 dBm @ 10 kHz V _{IS} centered between V _{CC} and GND (Figure 6)	V _{ONL}	3.0 4.5 5.5	-2 -2 -2	dB
Off-Channel Isolation	f = 100 kHz; V _{IS} = 1 V RMS V _{IS} centered between V _{CC} and GND (Figures 6 and 15)	V _{ISO}	3.0 4.5 5.5	-93	dB
Charge Injection Enable Input to Common I/O	V _{IS} = V _{CC} to GND, F _{IS} = 20 kHz t _r = t _f = 3 ns R _{IS} = 0 Ω, C _L = 1000 pF Q = C _L * ΔV _{OUT} (Figures 7 and 16)	Q	3.0 5.5	1.5 3.0	pC
Total Harmonic Distortion THD + Noise	F _{IS} = 20 Hz to 1 MHz, R _L = R _{gen} = 600 Ω, C _L = 50 pF V _{IS} = 3.0 V _{PP} sine wave V _{IS} = 5.0 V _{PP} sine wave (Figure 17)	THD	3.3 5.5	0.3 0.15	%

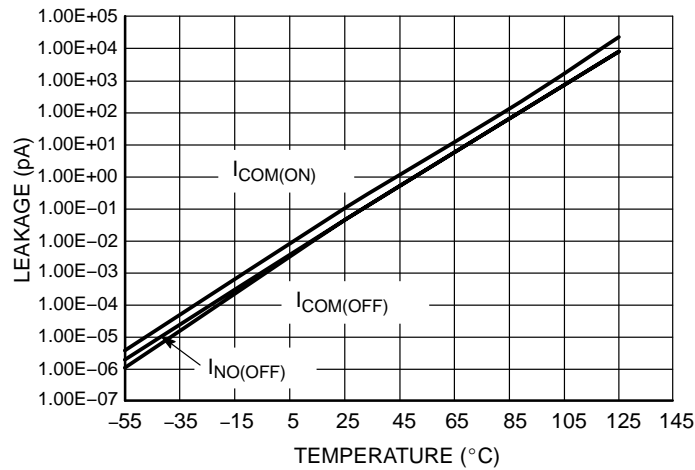

Figure 3. Switch Leakage vs. Temperature

NLAST4501

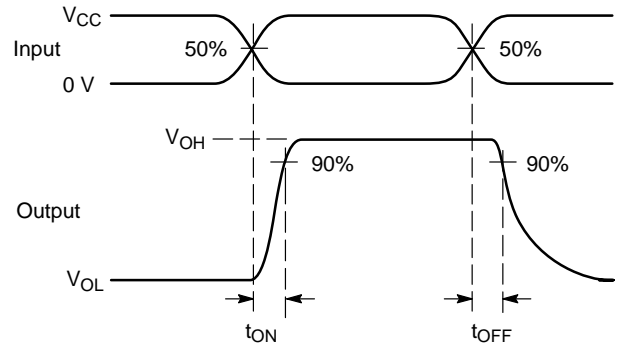
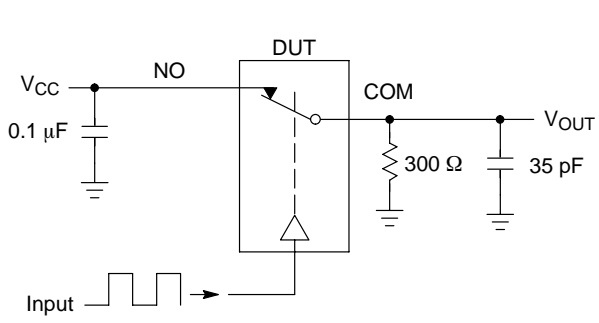

Figure 4. t_{ON}/t_{OFF}

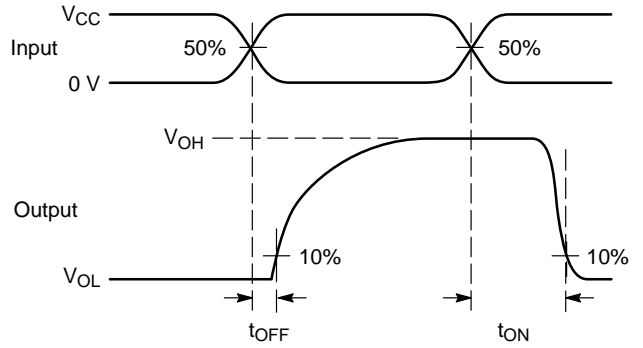
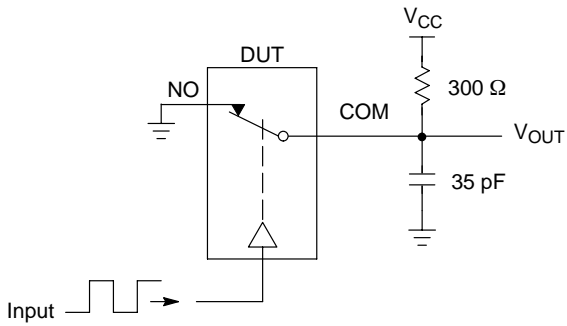
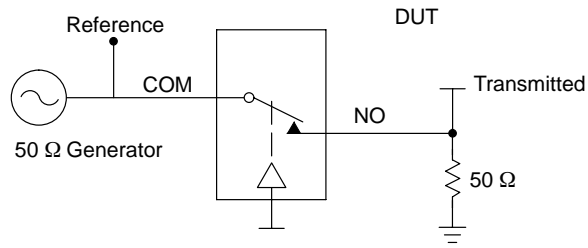

Figure 5. t_{ON}/t_{OFF}

NLAST4501



Channel switch control/s test socket is normalized. Off isolation is measured across an off channel. On loss is the bandwidth of an On switch. V_{ISO} , Bandwidth and V_{ONL} are independent of the input signal direction.

$$V_{ISO} = \text{Off Channel Isolation} = 20 \text{ Log} \left(\frac{V_{OUT}}{V_{IN}} \right) \text{ for } V_{IN} \text{ at } 100 \text{ kHz}$$

$$V_{ONL} = \text{On Channel Loss} = 20 \text{ Log} \left(\frac{V_{OUT}}{V_{IN}} \right) \text{ for } V_{IN} \text{ at } 100 \text{ kHz to } 50 \text{ MHz}$$

Bandwidth (BW) = the frequency 3 dB below V_{ONL}

Figure 6. Off Channel Isolation/On Channel Loss (BW)/Crosstalk (On Channel to Off Channel)/ V_{ONL}

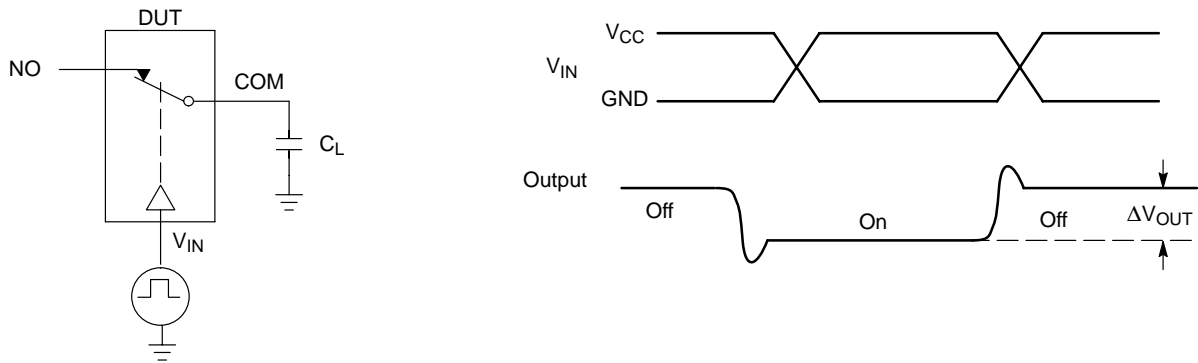

Figure 7. Charge Injection: (Q)

NLAST4501

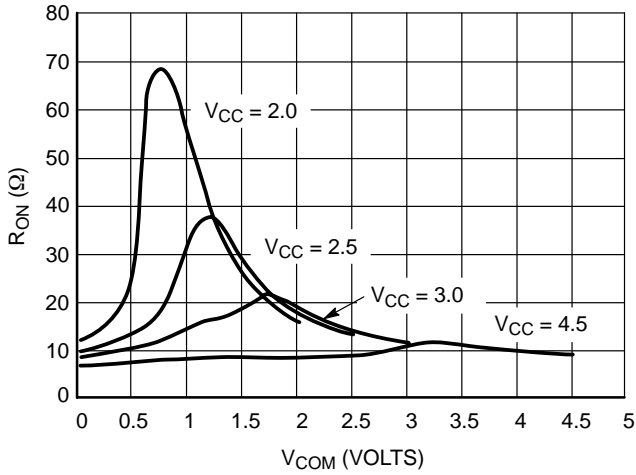

Figure 8. R_{ON} vs. V_{COM} and V_{CC} (@25°C)

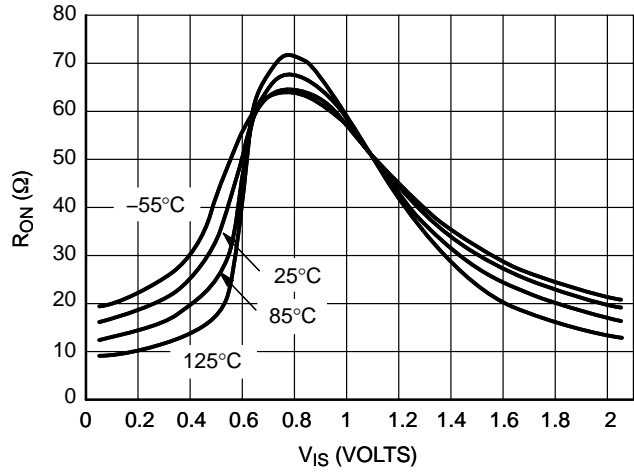

Figure 9. R_{ON} vs. V_{COM} and Temperature, $V_{CC} = 2.0$ V

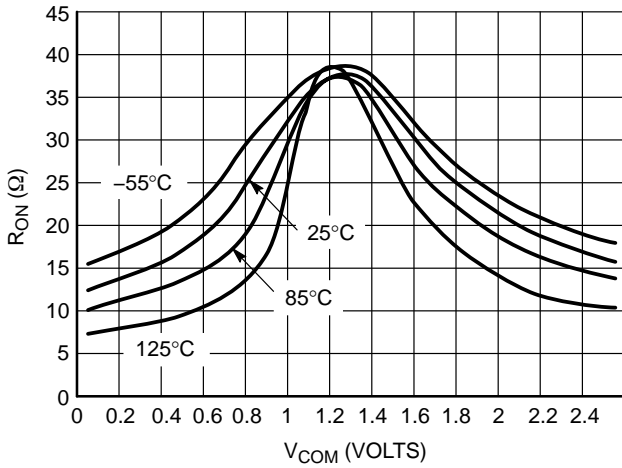

Figure 10. R_{ON} vs. V_{COM} and Temperature, $V_{CC} = 2.5$ V

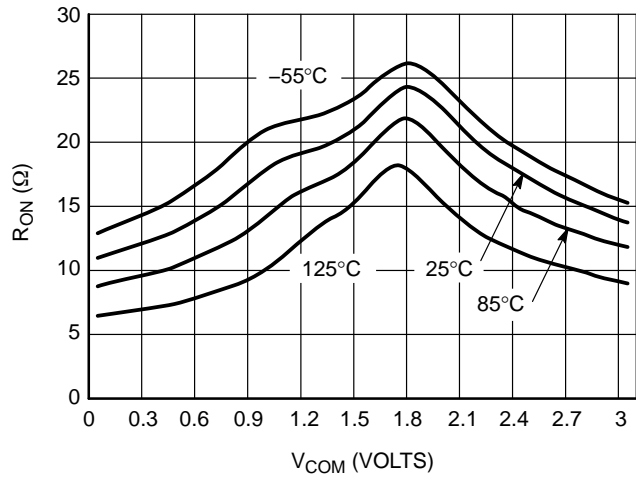

Figure 11. R_{ON} vs. V_{COM} and Temperature, $V_{CC} = 3.0$ V

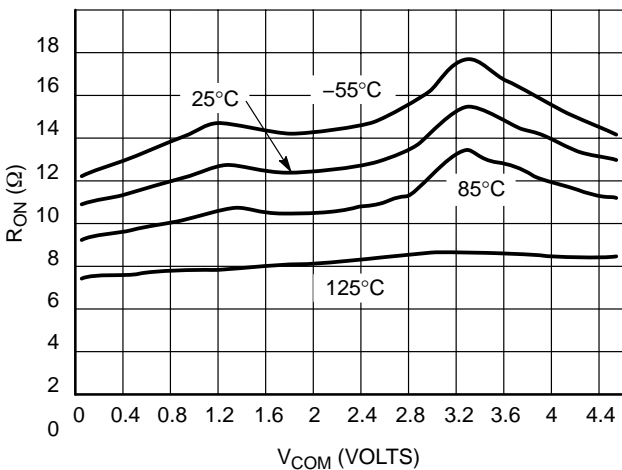

Figure 12. R_{ON} vs. V_{COM} and Temperature, $V_{CC} = 4.5$ V

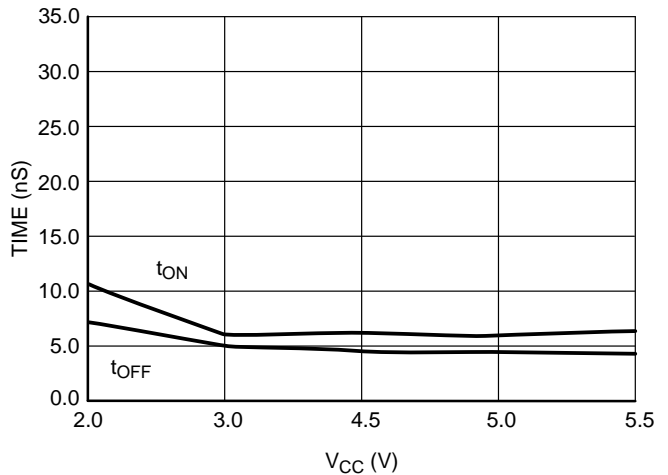

Figure 13. Switching Time vs. Supply Voltage, $T = 25^\circ\text{C}$

NLAST4501

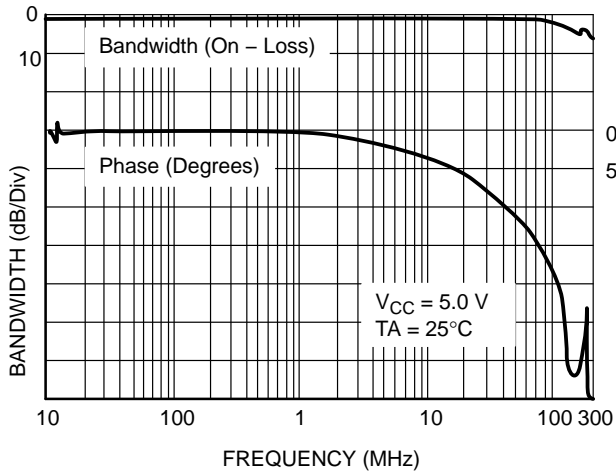

Figure 14. ON Channel Bandwidth and Phase Shift Over Frequency

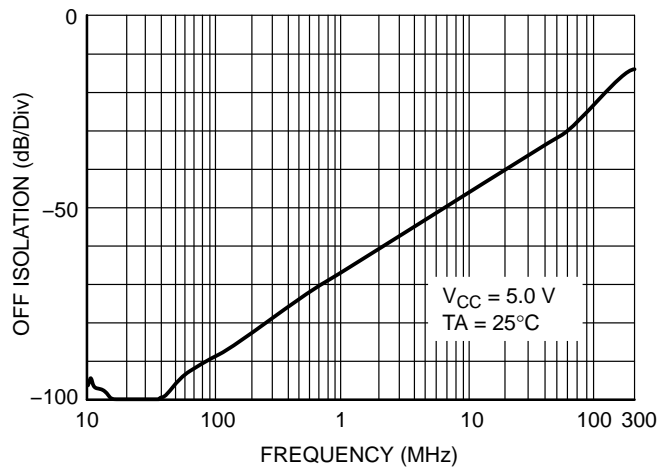

Figure 15. Off Channel Isolation

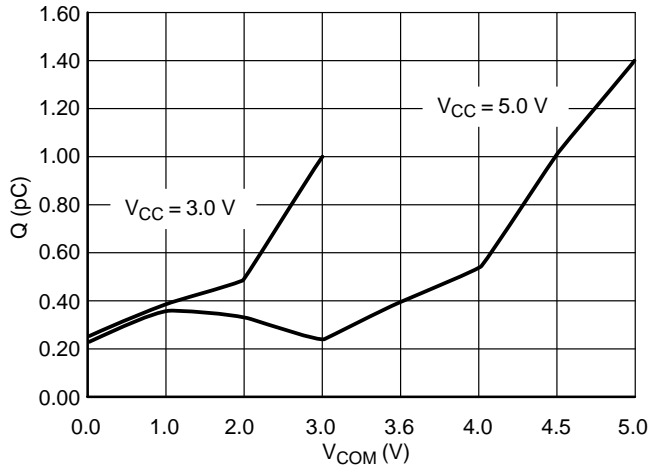

Figure 16. Charge Injection vs. V_{COM}

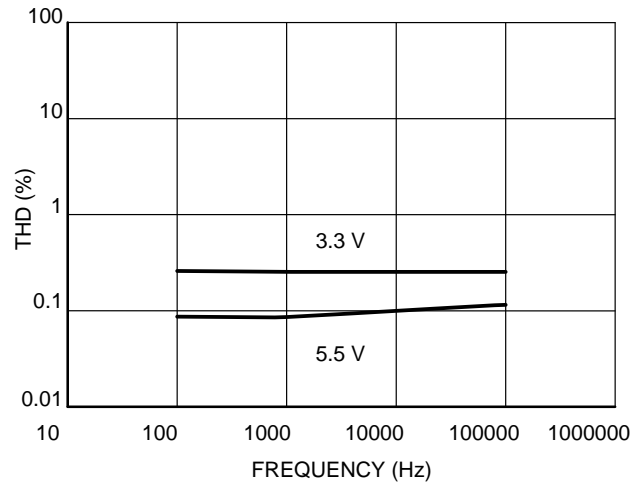

Figure 17. THD vs. Frequency

ORDERING INFORMATION

Device	Device Nomenclature					Package	Shipping†
	Circuit Indicator	Technology	Device Function	Package Suffix	Tape & Reel Suffix		
NLAST4501DFT2	NL	AST	4501	DF	T2	SC-88A/SOT-353/ SC70	3000/Tape & Reel
NLAST4501DFT2G						SC-88A/SOT-353/ SC70 (Pb-Free)	
NLAST4501DFT1				DT	T1	TSOP-5	
NLAST4501DFT1G						TSOP-5 (Pb-Free)	

†For information on tape and reel specifications, including part orientation and tape sizes, please refer to our Tape and Reel Packaging Specification Brochure, BRD8011/D.

MECHANICAL CASE OUTLINE

PACKAGE DIMENSIONS

ON Semiconductor®



SCALE 2:1

SC-88A (SC-70-5/SOT-353)
CASE 419A-02
ISSUE L

DATE 17 JAN 2013

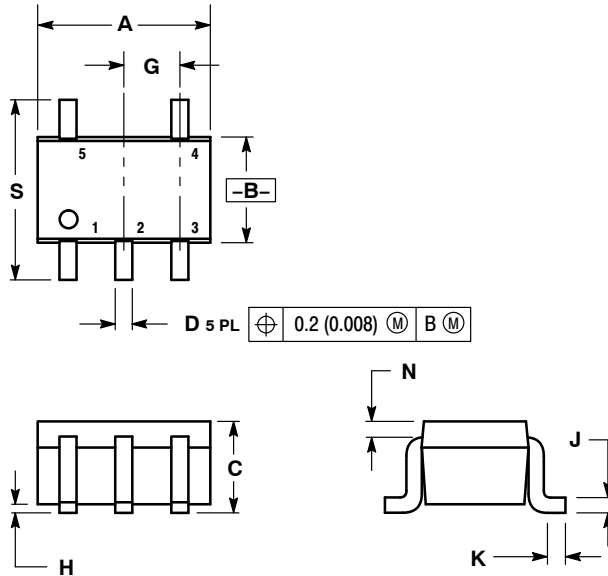

SOLDER FOOTPRINT

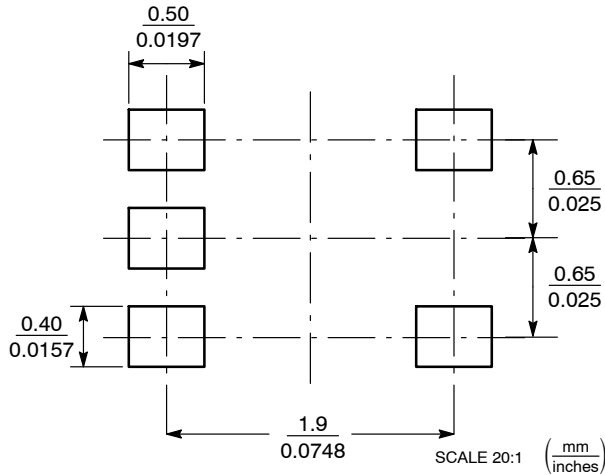

NOTES:

1. DIMENSIONING AND TOLERANCING PER ANSI Y14.5M, 1982.
2. CONTROLLING DIMENSION: INCH.
3. 419A-01 OBSOLETE. NEW STANDARD 419A-02.
4. DIMENSIONS A AND B DO NOT INCLUDE MOLD FLASH, PROTRUSIONS, OR GATE BURRS.

DIM	INCHES		MILLIMETERS	
	MIN	MAX	MIN	MAX
A	0.071	0.087	1.80	2.20
B	0.045	0.053	1.15	1.35
C	0.031	0.043	0.80	1.10
D	0.004	0.012	0.10	0.30
G	0.026 BSC		0.65 BSC	
H	---	0.004	---	0.10
J	0.004	0.010	0.10	0.25
K	0.004	0.012	0.10	0.30
N	0.008 REF		0.20 REF	
S	0.079	0.087	2.00	2.20

GENERIC MARKING DIAGRAM*

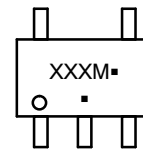

- XXX = Specific Device Code
- M = Date Code
- = Pb-Free Package

(Note: Microdot may be in either location)

*This information is generic. Please refer to device data sheet for actual part marking. Pb-Free indicator, "G" or microdot "■", may or may not be present. Some products may not follow the Generic Marking.

- | | | | | |
|----------------------------------------------------------------------------------------------------------------|----------------------------------------------------------------------------------------------|------------------------------------------------------------------------------------------------|--------------------------------------------------------------------------------------------------|--------------------------------------------------------------------------------------------------------------------------------------------------------------------|
| <p>STYLE 1:
PIN 1. BASE
2. EMITTER
3. BASE
4. COLLECTOR
5. COLLECTOR</p> | <p>STYLE 2:
PIN 1. ANODE
2. EMITTER
3. BASE
4. COLLECTOR
5. CATHODE</p> | <p>STYLE 3:
PIN 1. ANODE 1
2. N/C
3. ANODE 2
4. CATHODE 2
5. CATHODE 1</p> | <p>STYLE 4:
PIN 1. SOURCE 1
2. DRAIN 1/2
3. SOURCE 1
4. GATE 1
5. GATE 2</p> | <p>STYLE 5:
PIN 1. CATHODE
2. COMMON ANODE
3. CATHODE 2
4. CATHODE 3
5. CATHODE 4</p> |
| <p>STYLE 6:
PIN 1. EMITTER 2
2. BASE 2
3. EMITTER 1
4. COLLECTOR
5. COLLECTOR 2/BASE 1</p> | <p>STYLE 7:
PIN 1. BASE
2. EMITTER
3. BASE
4. COLLECTOR
5. COLLECTOR</p> | <p>STYLE 8:
PIN 1. CATHODE
2. COLLECTOR
3. N/C
4. BASE
5. EMITTER</p> | <p>STYLE 9:
PIN 1. ANODE
2. CATHODE
3. ANODE
4. ANODE
5. ANODE</p> | <p>Note: Please refer to datasheet for style callout. If style type is not called out in the datasheet refer to the device datasheet pinout or pin assignment.</p> |

DOCUMENT NUMBER:	98ASB42984B	Electronic versions are uncontrolled except when accessed directly from the Document Repository. Printed versions are uncontrolled except when stamped "CONTROLLED COPY" in red.
DESCRIPTION:	SC-88A (SC-70-5/SOT-353)	PAGE 1 OF 1

ON Semiconductor and are trademarks of Semiconductor Components Industries, LLC dba ON Semiconductor or its subsidiaries in the United States and/or other countries. ON Semiconductor reserves the right to make changes without further notice to any products herein. ON Semiconductor makes no warranty, representation or guarantee regarding the suitability of its products for any particular purpose, nor does ON Semiconductor assume any liability arising out of the application or use of any product or circuit, and specifically disclaims any and all liability, including without limitation special, consequential or incidental damages. ON Semiconductor does not convey any license under its patent rights nor the rights of others.

MECHANICAL CASE OUTLINE PACKAGE DIMENSIONS

ON Semiconductor®

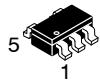

SCALE 2:1

TSOP-5 CASE 483 ISSUE N

DATE 12 AUG 2020

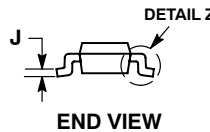
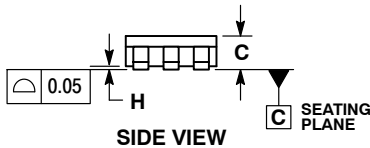
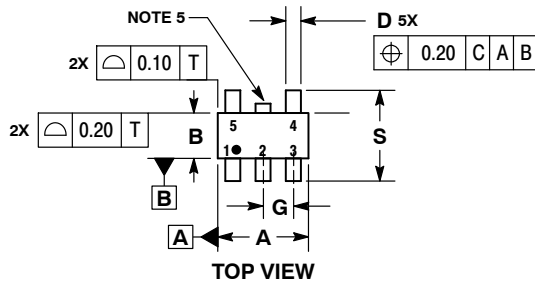

NOTES:

1. DIMENSIONING AND TOLERANCING PER ASME Y14.5M, 1994.
2. CONTROLLING DIMENSION: MILLIMETERS.
3. MAXIMUM LEAD THICKNESS INCLUDES LEAD FINISH THICKNESS. MINIMUM LEAD THICKNESS IS THE MINIMUM THICKNESS OF BASE MATERIAL.
4. DIMENSIONS A AND B DO NOT INCLUDE MOLD FLASH, PROTRUSIONS, OR GATE BURRS. MOLD FLASH, PROTRUSIONS, OR GATE BURRS SHALL NOT EXCEED 0.15 PER SIDE. DIMENSION A.
5. OPTIONAL CONSTRUCTION: AN ADDITIONAL TRIMMED LEAD IS ALLOWED IN THIS LOCATION. TRIMMED LEAD NOT TO EXTEND MORE THAN 0.2 FROM BODY.

DIM	MILLIMETERS	
	MIN	MAX
A	2.85	3.15
B	1.35	1.65
C	0.90	1.10
D	0.25	0.50
G	0.95 BSC	
H	0.01	0.10
J	0.10	0.26
K	0.20	0.60
M	0°	10°
S	2.50	3.00

SOLDERING FOOTPRINT*

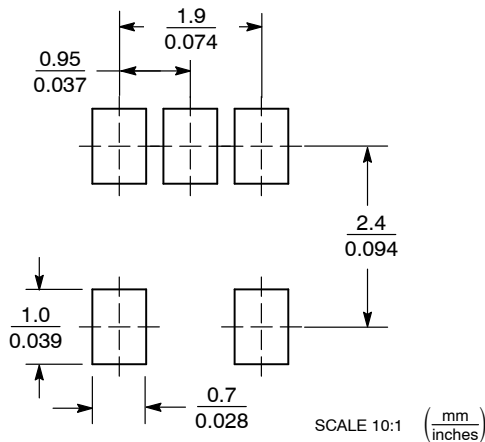

*For additional information on our Pb-Free strategy and soldering details, please download the ON Semiconductor Soldering and Mounting Techniques Reference Manual, SOLDERRM/D.

GENERIC MARKING DIAGRAM*



- XXX = Specific Device Code XXX = Specific Device Code
 A = Assembly Location M = Date Code
 Y = Year ■ = Pb-Free Package
 W = Work Week
 ■ = Pb-Free Package

(Note: Microdot may be in either location)

*This information is generic. Please refer to device data sheet for actual part marking. Pb-Free indicator, "G" or microdot "■", may or may not be present.

DOCUMENT NUMBER:	98ARB18753C	Electronic versions are uncontrolled except when accessed directly from the Document Repository. Printed versions are uncontrolled except when stamped "CONTROLLED COPY" in red.
DESCRIPTION:	TSOP-5	PAGE 1 OF 1

ON Semiconductor and ON are trademarks of Semiconductor Components Industries, LLC dba ON Semiconductor or its subsidiaries in the United States and/or other countries. ON Semiconductor reserves the right to make changes without further notice to any products herein. ON Semiconductor makes no warranty, representation or guarantee regarding the suitability of its products for any particular purpose, nor does ON Semiconductor assume any liability arising out of the application or use of any product or circuit, and specifically disclaims any and all liability, including without limitation special, consequential or incidental damages. ON Semiconductor does not convey any license under its patent rights nor the rights of others.

onsemi, **Onsemi**, and other names, marks, and brands are registered and/or common law trademarks of Semiconductor Components Industries, LLC dba "**onsemi**" or its affiliates and/or subsidiaries in the United States and/or other countries. **onsemi** owns the rights to a number of patents, trademarks, copyrights, trade secrets, and other intellectual property. A listing of **onsemi**'s product/patent coverage may be accessed at www.onsemi.com/site/pdf/Patent-Marking.pdf. **onsemi** reserves the right to make changes at any time to any products or information herein, without notice. The information herein is provided "as-is" and **onsemi** makes no warranty, representation or guarantee regarding the accuracy of the information, product features, availability, functionality, or suitability of its products for any particular purpose, nor does **onsemi** assume any liability arising out of the application or use of any product or circuit, and specifically disclaims any and all liability, including without limitation special, consequential or incidental damages. Buyer is responsible for its products and applications using **onsemi** products, including compliance with all laws, regulations and safety requirements or standards, regardless of any support or applications information provided by **onsemi**. "Typical" parameters which may be provided in **onsemi** data sheets and/or specifications can and do vary in different applications and actual performance may vary over time. All operating parameters, including "Typicals" must be validated for each customer application by customer's technical experts. **onsemi** does not convey any license under any of its intellectual property rights nor the rights of others. **onsemi** products are not designed, intended, or authorized for use as a critical component in life support systems or any FDA Class 3 medical devices or medical devices with a same or similar classification in a foreign jurisdiction or any devices intended for implantation in the human body. Should Buyer purchase or use **onsemi** products for any such unintended or unauthorized application, Buyer shall indemnify and hold **onsemi** and its officers, employees, subsidiaries, affiliates, and distributors harmless against all claims, costs, damages, and expenses, and reasonable attorney fees arising out of, directly or indirectly, any claim of personal injury or death associated with such unintended or unauthorized use, even if such claim alleges that **onsemi** was negligent regarding the design or manufacture of the part. **onsemi** is an Equal Opportunity/Affirmative Action Employer. This literature is subject to all applicable copyright laws and is not for resale in any manner.

PUBLICATION ORDERING INFORMATION

LITERATURE FULFILLMENT:

Email Requests to: orderlit@onsemi.com

onsemi Website: www.onsemi.com

TECHNICAL SUPPORT

North American Technical Support:

Voice Mail: 1 800-282-9855 Toll Free USA/Canada

Phone: 011 421 33 790 2910

Europe, Middle East and Africa Technical Support:

Phone: 00421 33 790 2910

For additional information, please contact your local Sales Representative